

APPLIED DAIRY MICROBIOLOGY

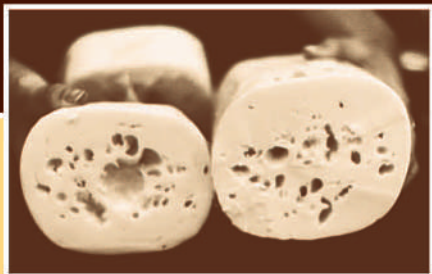

Second Edition, Revised and Expanded

edited by
Elmer H. Marth
James L. Steele

ISBN: 0-8247-0536-X

This book is printed on acid-free paper.

Headquarters

Marcel Dekker, Inc.

270 Madison Avenue, New York, NY 10016

tel: 212-696-9000; fax: 212-685-4540

Eastern Hemisphere Distribution

Marcel Dekker AG

Hutgasse 4, Postfach 812, CH-4001 Basel, Switzerland

tel: 41-61-261-8482; fax: 41-61-261-8896

World Wide Web

<http://www.dekker.com>

The publisher offers discounts on this book when ordered in bulk quantities. For more information, write to Special Sales/Professional Marketing at the headquarters address above.

Copyright © 2001 by Marcel Dekker, Inc. All Rights Reserved.

Neither this book nor any part may be reproduced or transmitted in any form or by any means, electronic or mechanical, including photocopying, microfilming, and recording, or by any information storage and retrieval system, without permission in writing from the publisher.

Current printing (last digit):

10 9 8 7 6 5 4 3 2 1

PRINTED IN THE UNITED STATES OF AMERICA

Preface to the Second Edition

The dairy industry continues to consolidate, with mergers reducing the number of companies producing dairy products. The number of dairy farms is also decreasing, but the remaining farms are larger and the volume of milk they produce is increasing slowly. The amount and variety of dairy products are also increasing, and, in fact, new products are regularly introduced into the marketplace.

As the industry continues to evolve, so does dairy microbiology. This second edition of *Applied Dairy Microbiology* reflects that evolution and provides the reader with the latest available information. There are now 18 chapters, rather than the 14 found in the first edition. Nearly all chapters that appeared in both editions have been revised and updated.

Chapter 1, “Microbiology of the Dairy Animal,” contains more information on *Escherichia coli* 0157:H7 and a discussion of bovine spongiform encephalopathy. Chapter 2, “Raw Milk and Fluid Milk Products,” has been rewritten by new authors and contains much information not found in the first edition. New bacterial standards for dried milk products appear in Chapter 3, “Concentrated and Dry Milks and Wheys.” Chapter 4, “Frozen Desserts,” includes information on sherbet, sorbet, and ice cream novelties. Chapter 5, “Microbiology of Butter and Related Products,” addresses current industrial practices and includes numerous figures. Chapter 6, “Starter Cultures and Their Use,” discusses isolation and enumeration of lactic acid bacteria.

Chapter 7 of the first edition has evolved into two chapters with new authors: “Metabolism of Starter Cultures” and “Genetics of Lactic Acid Bacteria.”

Both chapters deal with their subjects in far greater detail than in the first edition. Chapter 8 has also been split into two chapters, “Fermented Milks and Cream” (Chapter 9) and “Probiotics and Prebiotics” (Chapter 10).

“Cheese Products,” Chapter 11, discusses processed cheese products, and Chapter 12 covers “Fermented By-Products.” “Public Health Concerns,” Chapter 13, includes information on Creutzfeldt-Jakob disease.

Chapter 14, “Cleaning and Sanitizing in Milk Production and Processing,” is new to this edition of the book. This is followed by “Control of Microorganisms in Dairy Processing: Dairy Product Safety Systems” (Chapter 15). Another new addition to the book is Chapter 16, “Regulatory Control of Milk and Milk Products.” Chapter 17, “Testing Milk and Milk Products,” addresses rropy milk (an old problem that has reappeared) and provides views of a modern dairy testing laboratory. The final chapter, “Treatment of Dairy Wastes” (Chapter 18) rounds out the topic.

As was true of the first edition, the present book is intended for use by advanced undergraduate and graduate students in food/dairy science and food/dairy microbiology. The book also will be useful to persons in the dairy industry—both those involved in manufacturing products and those doing research. Furthermore, it should be beneficial to students in veterinary medicine and to veterinarians whose practice includes dairy animals. Finally, the book will be helpful to many persons in local, state, and federal regulatory agencies.

Elmer H. Marth
James L. Steele

Preface to the First Edition

Two books on dairy microbiology were published in 1957: *Dairy Bacteriology, 4th Edition* (B. W. Hammer and F. J. Babel, John Wiley and Sons, New York) and *Dairy Microbiology* (E. M. Foster, F. E. Nelson, M. L. Speck, R. N. Doetsch, and J. C. Olson, Jr., Prentice-Hall, Englewood Cliffs, New Jersey). Since then, no book on this subject has been published in the United States (although a two-volume work on dairy microbiology appeared in Europe).

When the two aforementioned books were published, there were numerous small dairy farms and dairy factories, and they produced a limited number of products. As time went on, dairy farms evolved into fewer but larger units with cows that produced more milk than in earlier years. Factories, too, decreased in number and increased in size and complexity. Furthermore, these factories began producing a far greater array of products than in the 1950s. All these changes have had an impact on dairy microbiology as it is currently understood and practiced.

Much of the information in the dairy microbiology books of the 1950s resulted from research done in dairy industry or closely related departments of most land grant universities. These departments also trained many of the workers in the dairy industry. As time went on, when problems occurred in other segments of the food industry, faculty in dairy industry departments were often consulted. In some instances, existing faculty responded to the new challenges; in others, faculty were added to work in various non-dairy segments of the food industry. Eventually, most dairy industry departments evolved into food science departments. This led to publication of several books on food microbiology—these

books usually contain a chapter or two on dairy microbiology but offer no thorough discussion of the subject.

Although food service departments have replaced most dairy industry departments in land grant universities, research on dairy microbiology has not stopped. In the 1980s, six centers for dairy research were established at various U.S. universities—the availability of funds through these centers and through national and several state promotional organizations served to stimulate research on dairy foods in general and on dairy microbiology in particular. Industrial research in this field has also expanded, but often the resulting information is proprietary.

This book updates and extends information available in earlier texts on dairy microbiology. In a manner unique to this book, it begins with a discussion of the microbiology of the milk-producing animal and how this relates to biosynthesis and quality of raw milk. This is followed by a series of chapters dealing with the microbiology of unfermented (except in a few instances) dairy foods: raw milk, fluid milk products, dried and concentrated milks and whey, frozen dairy desserts, and butter and related products. The book then considers fermented dairy foods by devoting two chapters to microorganisms used to manufacture these foods. The first of these describes starter cultures and how they are used. The second deals with genetics and metabolism of starter bacteria. Fermented dairy foods are discussed in the succeeding two chapters: cultured milks and creams in one, cheese products in the other. Another unique feature of this book is the discussion of probiotics in the chapter on cultured milks and creams. Probiotics refers to the purposeful ingestion of certain bacteria, usually dairy-related lactic acid bacteria, to improve the health and well-being of humans. Use of various microorganisms to produce valuable products through fermentation of whey, the principal by-product of the dairy industry, concludes this part of the book.

During the last four decades of the twentieth century there have been major and minor outbreaks of foodborne illness associated with dairy foods. Some of the outbreaks have been salmonellosis (nonfat dried milk, pasteurized milk, cheese, ice cream), staphylococcal food poisoning (butter, cheese, chocolate milk), and listeriosis (pasteurized milk, cheese, chocolate milk). In addition, pathogens responsible for these and other diseases have occasionally been found in dairy foods that did not cause illness. These developments have prompted concerns about public health in the food industry in general and the dairy industry in particular. Consequently, the largest chapter in this book deals with this important subject. The next chapter discusses control of pathogenic and spoilage microorganisms in processing dairy foods in which the concept of Hazard Analysis and Critical Control Points (HACCP) is emphasized.

Various microbiological tests are done to ensure the quality and safety of dairy foods. Sampling and testing are discussed in the penultimate chapter of the

book. Another unique feature of this book is the last chapter which provides information on treatment of dairy wastes, processes that are microbiological in nature.

There is some overlap among chapters in this book. For example, *Listeria monocytogenes*, *Salmonella*, psychrotrophic bacteria, lactic acid bacteria, milk composition, and bacterial standards for milk and some products are mentioned in more than one chapter. We could have exercised our prerogative as editors and eliminated the duplication, but we elected not to do so because: (a) many persons who use this book will not read it from cover to cover but instead will read one or two chapters of immediate interest and so the information in each chapter should be as complete as possible, (b) removing repetitive material, in most instances, would be detrimental to the flow of thought within a chapter and hence its readability, and (c) repetition enhances the educational value of the book—it's been said that the "three Rs" of learning are repetition, repetition, and repetition.

This book is intended for use by advanced undergraduate and graduate students in food/dairy science and food/dairy microbiology. It will also be useful to persons in the dairy industry—both those producing products and those doing research. In addition, it should be beneficial to students in veterinary medicine and to veterinarians whose practice includes dairy animals. Finally, the book will be helpful to many persons in local, state, and federal regulatory agencies.

Elmer H. Marth
James L. Steele

Contents

<i>Preface to the Second Edition</i>	iii
<i>Preface to the First Edition</i>	v
<i>Contributors</i>	xi
1. Microbiology of the Dairy Animal <i>Paul J. Weimer</i>	1
2. Raw Milk and Fluid Milk Products <i>Micaela Chadwick Hayes and Kathryn Boor</i>	59
3. Concentrated and Dry Milks and Wheys <i>Warren S. Clark, Jr.</i>	77
4. Frozen Desserts <i>Robert T. Marshall</i>	93
5. Microbiology of Butter and Related Products <i>Jeffrey L. Kornacki, Russell S. Flowers, and Robert L. Bradley, Jr.</i>	127
6. Starter Cultures and Their Use <i>Ashraf N. Hassan and Joseph F. Frank</i>	151
	ix

7.	Metabolism of Starter Cultures <i>Robert W. Hutkins</i>	207
8.	Genetics of Lactic Acid Bacteria <i>Jeffery R. Broadbent</i>	243
9.	Fermented Milks and Cream <i>Vikram V. Mistry</i>	301
10.	Probiotics and Prebiotics <i>Stanley E. Gilliland</i>	327
11.	Cheese Products <i>Mark E. Johnson</i>	345
12.	Fermented By-Products <i>David R. Henning</i>	385
13.	Public Health Concerns <i>Elliot T. Ryser</i>	397
14.	Cleaning and Sanitizing in Milk Production and Processing <i>Bruce R. Cords, George R. Dychdala, and Francis L. Richter</i>	547
15.	Control of Microorganisms in Dairy Processing: Dairy Product Safety Systems <i>Robert D. Byrne and J. Russell Bishop</i>	587
16.	Regulatory Control of Milk and Dairy Products <i>William W. Coleman</i>	613
17.	Testing of Milk and Milk Products <i>Charles H. White</i>	645
18.	Treatment of Dairy Wastes <i>W. L. Wendorff</i>	681
	<i>Index</i>	705

Contributors

J. Russell Bishop Center for Dairy Research, University of Wisconsin–Madison, Madison, Wisconsin

Kathryn Boor Department of Food Science, Cornell University, Ithaca, New York

Robert L. Bradley, Jr. Department of Food Science, University of Wisconsin–Madison, Madison, Wisconsin

Jeffery R. Broadbent Department of Nutrition and Food Sciences, Utah State University, Logan, Utah

Robert D. Byrne National Milk Producers Federation, Arlington, Virginia

Warren S. Clark, Jr. American Dairy Products Institute, Chicago, Illinois

William W. Coleman Dairy Consultant and former Director of the Dairy and Livestock Division of the Minnesota Department of Agriculture, St. Paul, Minnesota

Bruce R. Cords Environment, Food Safety, and Public Health, Ecolab, Inc., St. Paul, Minnesota

George R. Dychdala Ecolab Research and Development Center, Ecolab, Inc., St. Paul, Minnesota

Russell S. Flowers Silliker Laboratories Group, Inc., Homewood, Illinois

Joseph F. Frank Department of Food Science and Technology, The University of Georgia, Athens, Georgia

Stanley E. Gilliland Department of Animal Science and Food and Agricultural Products Center, Oklahoma State University, Stillwater, Oklahoma

Ashraf N. Hassan Department of Dairy Science, Minia University, Minia, Egypt

Micaela Chadwick Hayes Department of Food Science, Cornell University, Ithaca, New York

David R. Henning Dairy Science Department, South Dakota State University, Brookings, South Dakota

Robert W. Hutkins Department of Food Science and Technology, University of Nebraska, Lincoln, Nebraska

Mark E. Johnson Center for Dairy Research, University of Wisconsin–Madison, Madison, Wisconsin

Jeffrey L. Kornacki* Silliker Laboratories Group, Inc., Homewood, Illinois

Robert T. Marshall Department of Food Science, University of Missouri, Columbia, Missouri

Vikram V. Mistry Dairy Science Department, South Dakota State University, Brookings, South Dakota

Francis L. Richter Ecolab, Inc., St. Paul, Minnesota

Elliot T. Ryser Department of Food Science and Human Nutrition, Michigan State University, East Lansing, Michigan

* *Present affiliation:* Center for Food Safety, The University of Georgia, Griffin, Georgia.

Paul J. Weimer U.S. Dairy Forage Research Center, Agricultural Research Service, U.S. Department of Agriculture, and Department of Bacteriology, University of Wisconsin–Madison, Madison, Wisconsin

W. L. Wendorff Department of Food Science, University of Wisconsin–Madison, Madison, Wisconsin

Charles H. White Department of Food Science and Technology, Mississippi State University, Mississippi State, Mississippi

1

Microbiology of the Dairy Animal

Paul J. Weimer

*U.S. Department of Agriculture and University of Wisconsin–Madison
Madison, Wisconsin*

I. INTRODUCTION

Domestication of ruminant animals and their use to produce milk, meat, wool, and hides represents one of the cornerstone achievements in the history of agriculture. The essential feature of the ruminant animal that has fostered its utility as a dairy animal is the presence of a large pregastric chamber where microbial digestion of feed (particularly fibrous feeds not directly digestible by humans) provides various fermentation products that serve as precursors for efficient and voluminous synthesis of milk. Without this symbiosis between animal and microbe, the dairy industry would not have developed, and indeed human culture would be vastly different in its food-gathering methods.

The dairy animal is a host to a wide variety of microorganisms. Most of these are microbes in the digestive tract that are essential for fermentative digestion of the animal's feed. However, a number of other bacteria, fungi, and viruses can induce a pathogenic state in various organ systems resulting in fatal or nonfatal diseases. This chapter will focus first upon the microbiology of digestion by the normal flora and its occasional alteration by opportunistic microbes. This will be followed by a brief overview of the major infectious diseases and their effects on the animal and on the quantity and quality of milk produced. Most of the information presented has been obtained from research with cows, but much of it applies to sheep and goats as well.

II. THE DAIRY ANIMAL

A. Populations and Production

There are nearly three billion domestic ruminants in the world, the most numerous and economically important of which are cattle, sheep, goats, and buffalo (Table 1). Lactating dairy cattle (not including replacement heifers and dry cows) represent nearly one-fifth of the world's domestic cattle population and provide most of the world's milk supply. The numbers of sheep and goats actually used for milk production are difficult to estimate, but these species are of major importance in providing protein and energy to the human populations of developing countries and fill niche markets for specialty foods in developed countries. Both sheep and goats are regarded as superior to cattle in poor-quality grazing and browsing environments, in part because of more efficient retention of water and nitrogen (Devendra and Coop, 1982). Several other ruminant animal species (water buffalo, yak, camel, reindeer, and even the nonruminant horse) normally used in some cultures as sources of meat, hides, hair, or draft power are also milked for human consumption.

Because of their large size and abundant milk production, the Holstein is the predominant breed of dairy cow in use today. Improvements in animal breeding and genetics have yielded substantially larger animals over the years (Fig. 1) with corresponding increases in feed intake. This factor, combined with a gradual shift to diets having higher energy contents (i.e., higher proportions of grain) has resulted in a progressive increase in average milk production per cow, which in well-bred and well-managed herds may approach 13,600 kg (approximately 30,000 lb) per lactation.

Dairy cows are usually maintained on a 305-day lactation schedule, after which the cow is "dried" (by reducing feed and by not milking) for 2 months before calving to permit full development of the calf and to allow the buildup of body reserves necessary for the next lactation. After calving, milk production

Table 1 Worldwide Population of Domestic Ruminants and Worldwide Milk Production, 1998^a

Species	Population (10 ⁶ head)	Milk production (10 ⁶ metric tons)
Cattle	1318	
Dairy cattle	230	466.3
Sheep	1061	8.2
Goats	700	12.2
Buffalo	162	57.4

^a Source: Food and Agricultural Organization, 1999.

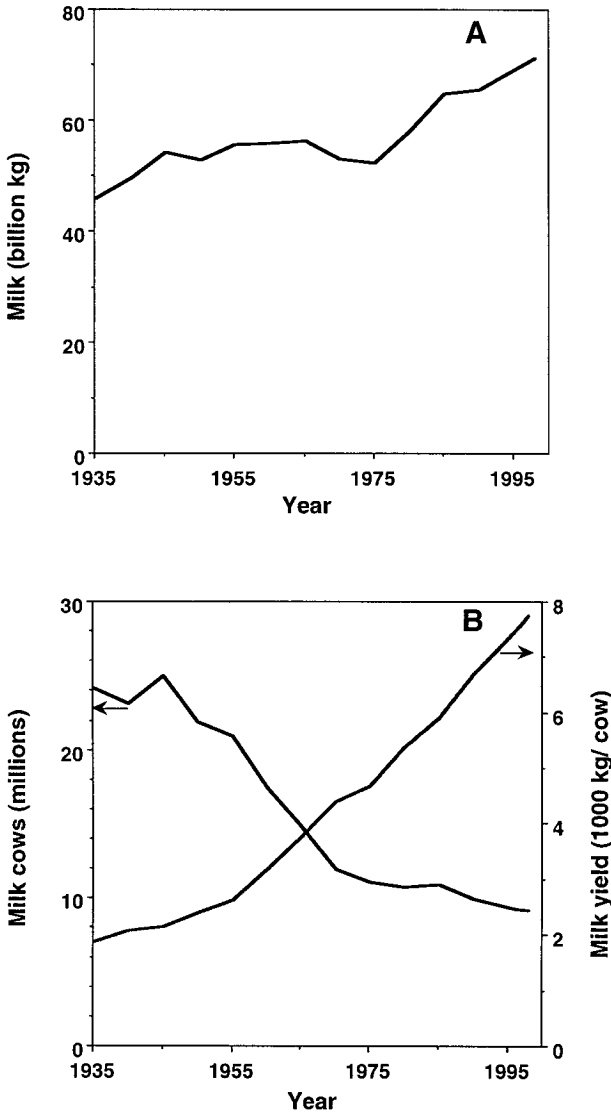

Figure 1 The gradual increase in annual milk production in the United States (Panel A) has been accomplished with a declining number of cows having an increasing average milk production (Panel B).

steadily increases over a 6- to 8-week period and then slowly decreases for the rest of the lactation. Normally, the cow is bred again at 11–12 weeks after calving, and delivers her next calf some 40 weeks later. Thus, the cow is pregnant for the bulk of her lactation.

B. Organization of the Digestive Tract

The rumen is the first of the four preintestinal digestive chambers in ruminant animals and is physically proximate to the second chamber, the reticulum (Fig. 2). Because of their location and their similar function, the physiology and microbiology of the rumen and reticulum are usually considered together. At birth, the ruminant is essentially a monogastric animal having a functional abomasum that digests a liquid diet (colostrum and milk) high in protein (Van Soest, 1994). As solids and fiber are gradually introduced into the diet, the other three preintestinal chambers develop over a period of approximately 7 weeks. The rumen is a large organ (approximately 10 L in sheep and goats but up to 150 L in high-producing dairy cows) that together with the reticulum constitute about 85% of the stomach capacity and contains digesta having 10–12% of the animal's weight (Bryant, 1970). In the rumen, microbial fermentation converts feed components into a mixture of volatile fatty acids (VFAs)—acetate, propionate, and butyrate (For the sake of brevity, these and other organic acids will be referred to in this chapter as their anionic forms, although they are normally metabolized and transported across the cell membrane in their protonated (uncharged) form. An exception is made in the discussion of lactic acidosis (see IV.D.1), where the acid itself is

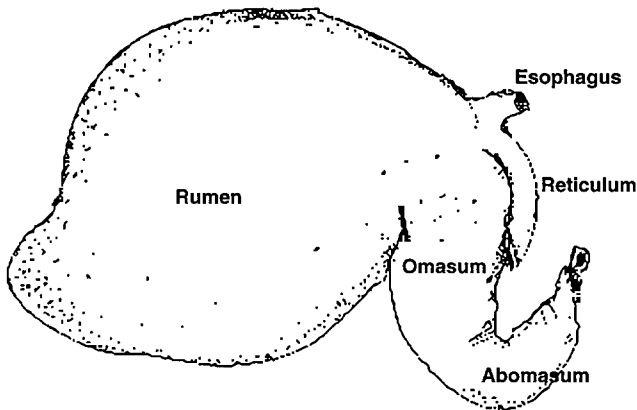

Figure 2 Schematic representation of the arrangement of the four preintestinal digestive chambers in the ruminant and illustrating the dominant size of the rumen.

responsible for the pathological condition.)—that are absorbed through the rumen wall for use by the animal as sources of energy and biosynthetic precursors. Thus, the ruminant animal cannot directly use carbohydrates for energy, and it is absolutely dependent upon its microflora to, in effect, predigest its food.

By virtue of its large size, the rumen has the function of slowing down the rate of passage of feed through the organ, which permits microbial digestion of essentially all of the nonstructural carbohydrate of the feed (starches and sugars) as well as over half of the more recalcitrant feed fiber (cellulose and hemicelluloses) (Van Soest, 1994). Rumen contents, which contain 6–18% dry matter, are mixed by strong muscular movement and are periodically returned via the esophagus to the mouth for additional chewing (rumination). Despite this, the solids have a tendency to stratify, with some maintaining a suspension in the rumen liquor, some settling to the bottom of the rumen, and some being borne up by gas bubbles to form a floating mat at the liquid surface. Passage rates vary with intake, with the rates for solids averaging about twice of that for liquids. From several published experiments, mean retention times for the rumen liquid range from 8 to 24 h, whereas that of the particulate phase range from 14 to 52 h (Broderick et al., 1991). The consequence of these long retention times for solids is that ruminant animals can use fibrous feeds (forages and certain agricultural byproducts) that are not usable by humans and other monogastric animals, with the ultimate conversion of these feedstuffs to useful products.

In addition to VFAs, other products of the fermentation include microbial cells and fermentation gases. The microbial cells eventually pass through the omasum and into the abomasum (the acidic “true stomach”), where the microbial cell protein is hydrolyzed to amino acids that are available for subsequent intestinal absorption. This microbial protein is a major contributor to the protein requirements of the animal, and it acts to counterbalance somewhat the considerable loss of feed protein that occurs as a result of microbial proteolysis and amino acid fermentation that occurs in the rumen (see Sec. IV.C.5).

Fermentation gases include primarily carbon dioxide (50–70%) and methane (30–40%). Rates of gas production immediately after a meal can exceed 30 L/h, and a typical cow may release 500 L of methane per day (Wolin, 1990). Although some gas is absorbed across the rumen wall and carried by the blood to the lungs for exhalation, most is eructated through the mouth.

III. MILK

A. Milk Composition

In the United States, milk has a strict legal definition: “the lacteal secretion, practically free of colostrum, obtained by complete milking of one or more healthy cows” (Office of the Federal Register, 1995). Parallel definitions are

provided for milk from goats and sheep (United States Public Health Service, 1993). Because of the central role of milk in the food supply and its ease of microbial contamination, production and processing of milk used for consumption is subject to tight regulation in most developed countries. In the United States, most milk is regulated according to the Grade A Pasteurized Milk Ordinance (United States Public Health Service, 1993), a document that sets the standards for all aspects of milk production and processing. From a microbiological standpoint, the Pasteurized Milk Ordinance is important primarily in its setting the standards for acceptable numbers of viable microorganisms in milk before and after pasteurization. The ordinance sets limits for microbial counts in raw milk for pasteurization at 1×10^5 /mL for milk from an individual producer and 3×10^5 /mL for commingled milk from multiple producers. The ordinance also establishes the permissible levels of antibiotic residues in milk, which affects the selection and implementation of antibiotic therapies to control infectious diseases in dairy animals.

In addition to the direct contamination of milk with pathogens, many microorganisms that are themselves not pathogenic can be responsible for altering the composition of milk after its synthesis. One example of a deleterious effect on milk is provided by mycotoxins. These compounds are secondary metabolites of fungi that can produce various toxic effects which can range from acute poisoning to carcinogenesis. The most widely known mycotoxins are the aflatoxins, which are produced by *Aspergillus flavus*, *A. parasiticus*, and *A. nomius*. Numerous structurally distinct aflatoxins have been identified (Fig. 3). The most notorious of these is aflatoxin B₁, one of the most potent carcinogens known. Milk and dairy products may be contaminated by mycotoxins either directly (by contamination of milk or other dairy products with fungi followed by their growth) or indirectly (by contamination of animal feed with subsequent passage of the mycotoxin to milk) (van Egmond, 1989). In either event, contamination is largely dependent upon environmental conditions that determine the ability of the fungi to grow and produce toxins.

Two of the more potent aflatoxins, B₁ and B₂, can be converted in the rumen to their respective 4-hydroxy derivatives, the somewhat less carcinogenic M₁ and M₂ (see Fig. 3). The extent of this conversion varies greatly among cows. For example, Patterson et al. (1980) reported that the M₁ concentration in the milk of six cows fed approximately 10 µg aflatoxin B₁/kg feed varied from 0.01 to 0.33 µg/L milk; on average ~2.2% of the ingested B₁ was converted to M₁. Applebaum et al. (1982) administered B₁ ruminally to 10 cows at higher doses (425–770 mg B₁/kg feed) and detected higher amounts of B₁ in milk (1.1–10.6 µg M₁/L). Feeding of, or ruminal dosing with, high concentrations of B₁ have significantly reduced feed intake and milk yield (Mertens, 1979). The effect is more powerful with impure B₁ than pure B₁; suggesting the synergistic effects of other mycotoxins present in the impure preparation. Several other researchers have noted substantial differences in M₁ concentration among cows at similar or

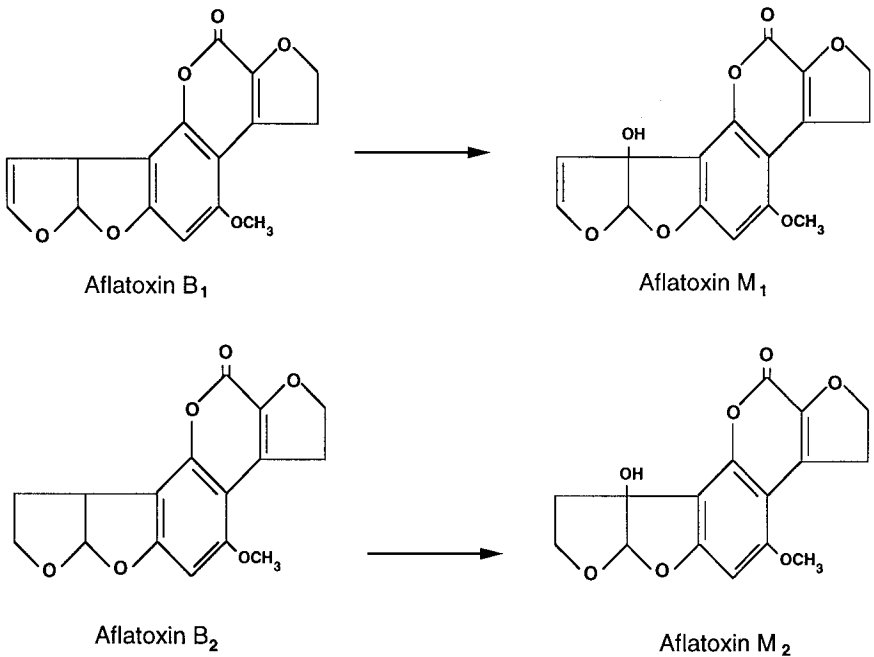

Figure 3 Bioconversion of aflatoxins B₁ and B₂ to M₁ and M₂, respectively.

different stages of milk production and milk yield and between milkings of the same cow (Kiermeier et al., 1977; Lafont et al., 1980).

B. Milk Biosynthesis

In evaluating the microbial role in providing the animal with milk precursors, it is useful briefly to describe the biosynthesis of milk. A more detailed treatment of the process is provided by Bondi (1983).

Although the mammary gland comprises only 5–7% of the dairy cow's body weight, it represents perhaps the animal's highest concentration of metabolic activity. Careful breeding and advances in nutrition over the years have resulted in the annual production of milk nutrients from a single cow sufficient to provide the nutrients required by 50 calves.

Milk is produced in secretory cells clustered in groups known as alveoli. These cells feed milk through an arborescent duct system that collects milk into the udder. Production of milk is strongly controlled by endocrine hormones. Following parturition, the cells secrete antibody-rich colostrum for several days until

milk secretion begins. Continued production of milk is stimulated by suckling or by milking through the stimulation of several hormones, particularly prolactin.

Nutrients for milk synthesis are provided to the udder through the blood via a pair of major arteries. The ability of the mammary gland to capture milk precursors effectively from the arterial blood supply—expressed as a “per cent extraction” calculated from the difference of precursor concentrations in arterial and venous blood—is truly impressive (Table 2) when one considers the rapid flow of arterial blood through the udder, which in dairy cows can approach 20 L/min. Production of 1 L of milk requires approximately 500 L of arterial blood flow through the udder.

Milk is predominantly (80–87%) water. The major components of milk solids are lactose, protein, and fats. The composition of milk varies with feeding regimens, individual animals, and breed. Marked differences are also noted among different ruminant species as well, with sheep’s milk having substantially greater content of protein and fat than the milk of cows or goats (Table 3). Much of the energy required for biosynthesis of milk in the udder is produced by oxidation of glucose (30–50%) or acetate (20–30%). In the ruminant animal, glucose is not derived directly from dietary carbohydrate, but is instead produced by gluconeogenic pathways, primarily using propionate, a major product of the ruminal fermentation.

Lactose, a disaccharide of D-glucose and D-galactose linked by an α -1,4-glycosidic bond, is synthesized by a series of reactions using D-glucose as the starting substrate. Approximately 60% of the glucose consumed in the mammary gland is used for lactose synthesis. Lactose concentration in milk is relatively invariant with diet and stage of lactation, although its concentration declines substantially in mastitic cows (see Sec. VI.A).

Table 2 Arterial Concentrations of Milk Precursors and the Efficiency of Their Extraction in the Udder of Goats

Precursor	Arterial concentration (mg/L)	Extraction efficiency (%)
Blood:		
O ₂	119	45
Glucose	445	33
Acetate	89	63
Lactate	67	30
Plasma:		
3-Hydroxybutyrate	58	57
Triglycerides	219	40

Source: Bondi, 1983.

Table 3 Mean Composition of Milk from Domestic Ruminants

Component	% by weight in milk		
	cow	goat	sheep
Fat	3.5	4.5	7.4
Protein	2.9	2.9	5.5
Lactose	4.9	4.1	4.8
Ca	0.12	0.13	0.20
P	0.10	0.11	0.16

Source: Bondi, 1983.

Milkfat is a heterogeneous combination of triglycerides with very few (<2%) phospholipid or sterols. Triglycerides are composed of glycerol esterified to three molecules of fatty acids having 4–20 carbon atoms (almost exclusively even numbered). In all mammalian species, the fatty acids are derived in part from circulatory lipoproteins produced from dietary or body fat. These lipoproteins are hydrolyzed at the endothelial capillary wall and are subsequently recombined to produce milk triglycerides. In ruminant animals, almost half of the fatty acids are synthesized from acetate produced in the ruminal fermentation and from 3-hydroxybutyrate produced in the rumen wall from butyrate, another ruminal fermentation product. Milkfat content is subject to variations in diet; because milkfat is an important determinant of selling price, diets which depress milkfat yield are avoided even if they provide good milk yields. The Pasteurized Milk Ordinance stipulates that whole milk in its final packaged form for beverage use shall contain $\geq 8.25\%$ “milk solids not fat” and $\geq 3.25\%$ fat (United States Public Health Service, 1993).

Protein in milk is predominantly (82–86%) casein with smaller amounts of globulins. Milk proteins are synthesized from amino acids extracted from the arterial blood supply. These amino acids, in turn, are derived from several sources: synthesis by the animal, dietary protein that escapes the rumen, and microbial protein produced in the rumen and hydrolyzed to amino acids and peptides by passage through the abomasum (see Sec. IV.C.5).

IV. MICROBIOLOGY OF THE RUMEN

A. Methods

Rumen microbiology is of historical importance in that the rumen was the first anaerobic habitat whose microbiology was systematically investigated. Many of the techniques for study of strictly anaerobic microbes were developed in these

research programs, beginning with the pioneering studies of the research groups of Robert Hungate and Marvin Bryant in the 1940s. In fact, despite the difficulties inherent in studying a habitat of limited accessibility and the requirements for experimental work under strictly anaerobic conditions, the rumen has come to be regarded as one of the best-understood of all microbial habitats.

Most studies of ruminal microbes have been conducted in batch culture, usually at fairly high substrate concentrations. This growth mode has been useful for examining the products and kinetics of digestion by mixed ruminal microflora (so-called *in vitro* digestion experiments); for isolating and characterizing pure cultures; and for examining interactions among microorganisms at different trophic levels (e.g., interspecies H₂ transfer reactions; see Sec. IV.C.4). Studies have also been carried out in continuous culture in which substrates are fed either continuously or at defined (e.g., hourly) intervals. This mode of growth is more useful for some types of studies, because under proper conditions it can simulate the feeding schedule of the animal.

One type of continuous culture, the chemostat, has been widely used in growth studies. In this mode of culture, one substrate in the feed medium is present at a concentration that limits microbial growth. Feeding of the culture vessel at different volumetric flow rates results in the achievement of a steady state in which the rate of microbial growth is equal to the dilution rate [that is, (volumetric flow rate)/(working volume of the culture vessel)]. The chemostat allows the experimenter to examine the microbial response to growth at suboptimal rates; an important consideration because microbes in nature normally grow at rates well below their maxima (Slater 1988). Appropriate fitting of data to theoretically derived equations permits determination of fundamental growth parameters such as affinity constants, true growth yields, and maintenance coefficients (see Sec. IV.C.5.b). Until recently, chemostat studies were limited to using soluble substrates, but several new configurations have permitted growth in a continuous mode on insoluble substrates such as cellulose (Kistner and Kornelius, 1990; Weimer et al., 1991). Culture systems have also been constructed that allow differential flow rates for solids and liquids, further approximating the conditions in the rumen (Hoover et al., 1983). However, no laboratory culture method can fully simulate the complexities of digestion within the rumen itself, because *in vivo* digestion involves not only microbial activity but also rumination and mastication, salivary secretions, and recycling of some nutrients.

B. The Ruminal Environment

Much of our understanding of the physiology and microbiology of the rumen has come from *in vitro* studies of rumen contents. Early studies with rumen contents used samples recovered from animals at the slaughterhouse, but the microbiology of the rumen under such conditions does not represent that of the living

ruminant owing to the practice of withholding food from the animal for at least 24 h before slaughter. More realistic studies of rumen microbiology were facilitated by development of procedures to sample the rumen via a stomach tube or a surgically implanted fistula (Fig. 4). The latter allows recovery of a more representative grab sample containing both solids and liquor, and it provides a port for periodic insertion or removal of test materials (e.g., feedstuffs placed in nylon-mesh bags) for measurement of digestion *in situ*.

Ruminal studies have revealed that the physical and chemical conditions within the rumen are fairly constant. Rumen temperature remains within a few degrees of 39°C as a result of heat production by both animal tissues and the microflora of the digestive tract. Despite the continuous influx of O₂ into the rumen through swallowing of feed and water and through diffusion from the bloodstream via the capillaries feeding the gut epithelial cells, the rumen remains highly anaerobic, with O₂ concentrations ranging from 0.25 to 3.0 μM (Ellis et al., 1989). Maintenance of these low concentrations of oxygen appears to result from the combined effects of facultative anaerobes and strict anaerobes (protozoa and bacteria). The strict anaerobes can apparently consume substantial amounts of O₂ in reactions involving H₂ oxidation as long as concentrations of O₂ remain below 7 μM (Ellis et al., 1989). The rumen is not only anaerobic but also highly reducing, with an oxidation-reduction potential near -400 mV.

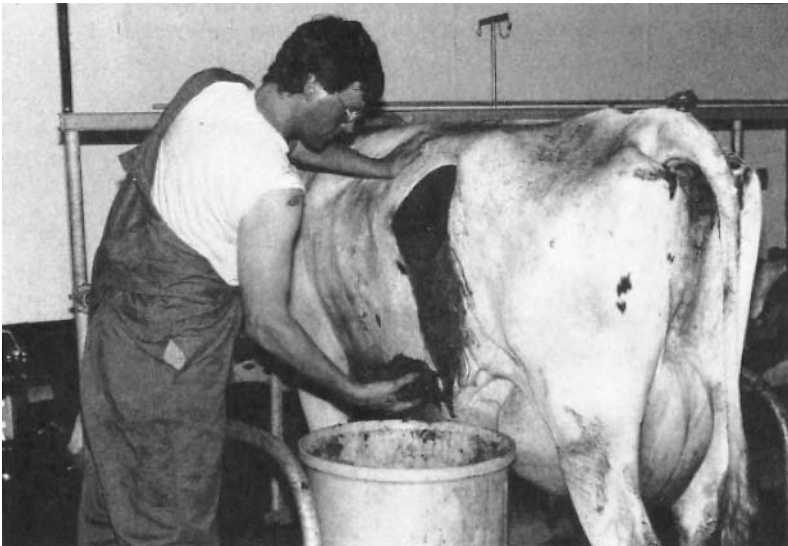

Figure 4 A researcher removing a sample of digesta from a ruminally fistulated cow.

Ruminal pH varies within the range of approximately 5–7 because of opposing forces of microbial fermentation to produce acids on the one hand and their absorptive removal on the other (Table 4). Buffering is provided by the secretion of bicarbonate-rich saliva, which in high-producing dairy cows may approximate 150 L/day (Church, 1988). Normally, pH is highest immediately before feeding; pH values below 5 are usually associated with certain undesirable conditions (e.g., lactic acidosis; see Sect. V.E.1).

Total concentrations of ruminal VFAs and their molar proportions vary with diet, but total VFAs are generally near 100 mM, with the molar proportions of acetate, propionate, and butyrate approximately 68, 20, and 10%, respectively (Mackie and Bryant, 1994); small amounts of isobutyrate, isovalerate, valerate, and caproate are also usually present.

C. The Ruminal Microbial Population

The microbial population in the rumen includes numerous species of bacteria, protozoa, and fungi. There appear to be few differences among cattle, goats, and sheep with regard to either the digestibility of feeds or the species of microbes inhabiting the rumen (Baumgardt et al., 1964; Jones et al., 1972). In terms of sheer numbers of cells, the bacteria far outstrip the eukaryotes, but the latter group—because of their large cell size—contribute considerably to ruminal microbial biomass.

1. Bacteria

More than 200 different bacterial species have been isolated from rumen contents and their properties determined, but only about 24 species are thought to be of

Table 4 Factors Controlling Ruminal pH

Factor	Determinants and remarks
pH of feed	Near neutrality for fresh herbage, hay and grains Acid (pH < 5) for silages
Acid production	Diet composition (maximum rate and extent of digestion) Feeding schedule (pH highest just before feeding) Microbial populations (species composition and fermentation pathways)
Acid absorption across ruminal wall	Fermentation product ratios (VFAs absorbed faster than lactate)
Salivation	Amount of saliva Buffer capacity of saliva (concentrations of bicarbonate and phosphate)

major importance in ruminal metabolism (Table 5). Like any natural environment, the rumen probably contains many other species that have to now resisted isolation. Moreover, the recent use of phylogenetic criteria (i.e., sequences of evolutionarily conserved macromolecules such as 16S ribosomal RNAs) in taxonomy has altered microbiologists' concepts of what constitutes a microbial species. As a result, new species will continue to be described, although the major functional groups of bacteria have probably been identified. The bacterial population can carry out essentially all of the enzymatic reactions that occur in the rumen with regard to digestion of feed materials, and bacteria are probably the main agents of ruminal digestion of carbohydrate and protein in feed. The pathways for conversion of carbohydrate (the ruminant's major energy source) to different fermentation endproducts are shown in Figure 5.

Total populations of bacteria in the rumen are hard to measure with accuracy, because a large fraction (perhaps up to 70%) of the cells are attached to solid surfaces [mostly to feed particles (Hobson and Wallace, 1982; Costerton et al., 1987), but to a certain degree to the rumen wall as well (Mead and Jones, 1981)]. Thus, bacterial cell counts of 10^7 – 10^9 cells/mL, normally determined by counting unattached cells under the microscope or by plating onto nonselective culture media, must be regarded as considerable underestimates of the total population. The same must be said for the many studies on quantitating individual species or physiological groups by traditional culture methods. Recent use of nucleotide probes directed toward 16S rRNAs of specific phylogenetic units (e.g., kingdom, species, or strain) has shown great promise for in situ studies of ruminal microbial ecology (Stahl et al., 1988), and it has been applied successfully to in vitro studies of ruminal contents (Krause and Russell, 1996) and defined cocultures of ruminal bacteria (Odenyo et al., 1994).

In general, ruminal bacteria are adapted to grow within a fairly narrow range of environmental conditions, which is hardly surprising given the relative constancy of environmental conditions in the rumen. Ruminal bacteria are mesophilic but are highly stenothermal (i.e., they grow within a narrow temperature range). Most have growth optima near the mean ruminal temperature of 39°C, and many exhibit poor or no growth at room temperature. Most ruminal bacteria also have some requirements for vitamins and amino acids that are present in low concentrations in the ruminal liquor (Bryant, 1970). Many species also require branched-chain VFAs for growth (Dehority, 1971). Because environmental conditions are fairly constant and organic growth substrates are continuously available, few ruminal bacteria have developed the capability to form resistant morphological forms, such as cysts or spores. In fact, although various endospore-forming *Clostridium* species have been isolated from the rumen, they are rarely abundant, and in some instances may simply be transients that have little involvement in ruminal metabolism (Varel et al. 1995).

Table 5 Physiological Properties of Ruminant Bacteria

Nutritional type	Gram	Substrates utilized ^a	Products formed ^b	Additional characteristics
Fibrolytic				
<i>Butyrivibrio fibrisolvens</i>	— ^d	C, Cd, Xn, Xd, P	For, But, Ac, Lac, EtOH, CO ₂	
<i>Clostridium</i> spp. ^c	+	C, G ₂ , Hx	For, Ac, But, CO ₂	Form endospores
<i>Fibrobacter succinogenes</i>	—	C, Cd	Suc, Ac, For	
<i>Lachnospira multiparus</i>	—	P, G ₂	For, Ac, EtOH, Lac, H ₂ , CO ₂	
<i>Ruminococcus albus</i>	+	C, Cd, Xn, Xd	Ac, EtOH, H ₂ , For, CO ₂	
<i>Ruminococcus flavefaciens</i>	+	C, Cd, Xn, Xd, P	Ac, Suc, H ₂ , For, CO ₂	
<i>Succinivibrio dextrinosolvens</i>	—	P, Hx	Suc, Ac, For	
Starch and sugar digesters				
<i>Actinobacillus succinogenes</i>	+	Hx, G ₂ , F, Mt, X, A	Succ, Ac, Pyr, EtOH	Facultative anaerobe
<i>Eubacterium ruminantium</i>	+	Hx, G ₂ , F, MeOH, P, Xd	For, Ac, But, Lac	
<i>Megasphaera elsdenii</i>	—	S, Mt, Sc, Gol, Pep	For, Ac, Pro, But, H ₂ , CO ₂	Converts Lac → Pro
<i>Prevotella ruminicola</i>	—	S, Cd, Hx, Xd, L, F, P, Prot	For, Ac, Pro, Suc	
<i>Pseudobutyrvibrio fibrisolvens</i>	— ^d	G ₂ , Hx, F, X	For, But, Lac, CO ₂	
<i>Ruminobacter amylophilus</i>	—	S, Mt	Suc, For, Ac	Hydrolyzes pectin
<i>Selenomonas ruminantium</i>	— ^d	S, Cd, Hx, X, A, Gol, P, Prot, Xd, Suc	Pro, Ac, But, For, Suc, Lac, H ₂	A major agent of Suc → Pro and Lac → Pro
<i>Streptococcus bovis</i>	+	S, G ₂ , Hx, Prot	Lac, EtOH, Form, Ac, CO ₂	Hydrolyzes pectin
<i>Succinomonas amylolytica</i>	—	S, G, Mt	Suc, Ac, Pro, H ₂	
<i>Treponema bryantii</i>	—	Hx, X, A, G ₂ , L, Mt	For, Ac, Suc	
Proteolytic/amino acid fermenting				
<i>Clostridium aminophilum</i>	+	Pep, AA	Ac, But, BCVFAs, NH ₃ , CO ₂	

<i>Clostridium sticklandii</i>	+	Pep, AA	Ac, But, BCFVAs, NH ₃ , CO ₂	
<i>Peptostreptococcus anaerobius</i>	+	Pep, AA	Ac, But, BCFVAs, NH ₃ , CO ₂	
Hydrogen consumers				
<i>Acetitomaculum ruminis</i>	+	H ₂ + CO ₂ , Hx	Ac	Probably not an important H ₂ consumer in the rumen
<i>Desulfovibrio ruminis</i>	-	H ₂ + SO ₄ ⁻ , EtOH, Lac	H ₂ S; Ac + H ₂	Produces H ₂ from EtOH and Lac in presence of methanogens
<i>Methanobrevibacter bryantii</i>	+	H ₂ + CO ₂	CH ₄	Autotrophic
<i>Methanosarcina barkeri</i>	+	H ₂ + CO ₂ , MeOH	CH ₄	Autotrophic, methylotrophic
<i>Wolinella succinogenes</i>	-	fumarate + H ₂ , formate, or H ₂ S	Suc	Can also reduce inorganic nitro compounds (e.g., NO ₃ ⁻)
Other nutritional specialists				
<i>Acidaminococcus fermentans</i>	- ^d	Glu, Cit, TAA	Ac, But, H ₂	Detoxifies TAA
<i>Anaerovibrio lipolytica</i>	-	TG, Gol, F, Rib	Pro, Ac, But, Suc, H ₂ , CO ₂	
<i>Oxalobacter formigenes</i>	-	Oxalate	For, CO ₂	Detoxifies oxalate
<i>Succiniclasticum ruminis</i>	-	Suc	Pro, CO ₂	
<i>Synergistes jonesii</i>	+	Arg, His, DHP	Ac, Pro, H ₂	Detoxifies mimosine
<i>Veillonella parvula</i> ^e	- ^d	Lac, Gol	Ac, Pro, H ₂ , CO ₂	

^a AA, amino acids; Arg, arginine; Cd, cellodextrins (except where indicated, glucose also fermented); DHP, 2,3- and 3,4-dihydroxypyridinediols; EtOH, ethanol; F, fructose; For, formate; G, glucose; G₂, cellobiose; Glu, glutamate; Gol, glycerol; His, histidine; Hx, most common hexose sugars; L, lactose; Lac, lactate; MeOH, methanol; P, pectin; Pep, peptides; Prot, protein; TG, triglycerides; X, xylose; Xd, xylodextrins; Xn, xylan.

^b Ac, acetate; BCFVAs, branch-chain volatile fatty acids (isobutyrate, isovalerate, 2-methylbutyrate); But, butyrate; EtOH, ethanol; For, formate; Lac, lactate; Pro, propionate; Suc, succinate.

^c Includes *C. cellobioparum*, *C. chartatabidium*, *C. lochheadii*, *C. longisporum*, *C. polysaccharolyticum*. A few of these species also produce ethanol.

^d Stain gram negative but phylogenetically related to gram positive eubacteria.

^e Abundant in ovine rumen but not bovine rumen.

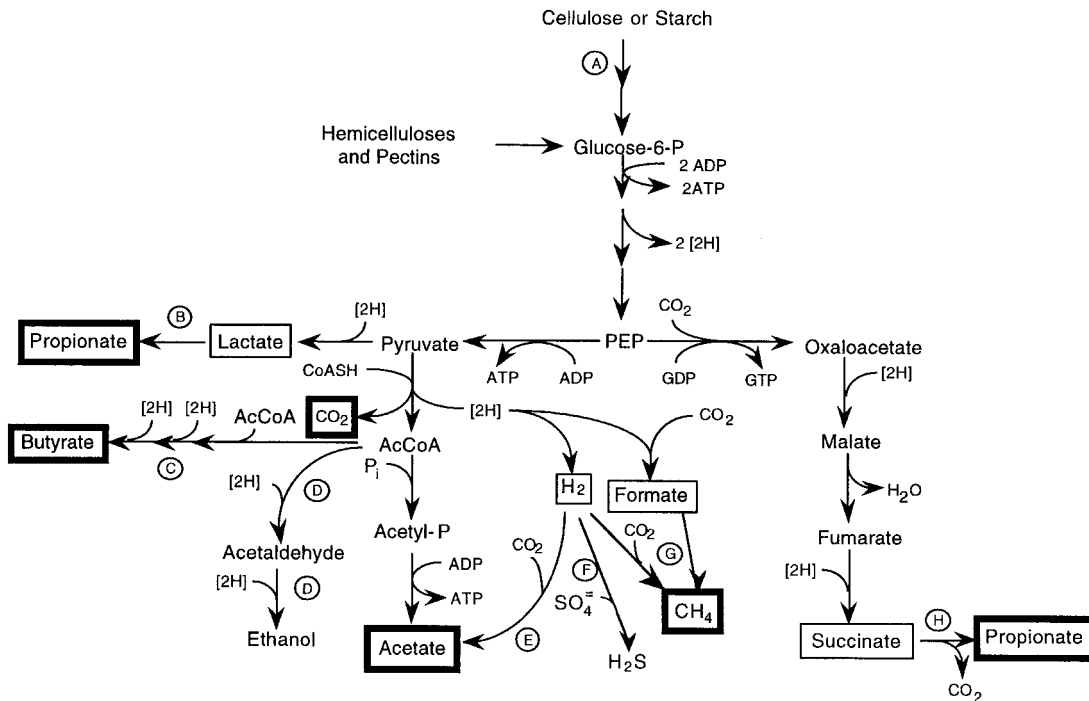

Figure 5 Generalized pathway of carbohydrate fermentations in the rumen. Fermentation products in dark bordered boxes are maintained in substantial concentrations in the normal rumen. Fermentation products in light bordered boxes are produced and excreted by some organisms but do not accumulate under normal conditions. Abbreviations: [2H], pairs of reducing equivalents; ADP and ATP, adenosine di- or triphosphate; GDP and GTP, guanosine di- and triphosphate; PEP, phosphoenolpyruvate; AcCoA, acetyl coenzyme A. Reactions coded by a circled letter are restricted to a few species, as follows: A, fibrolytic or amylolytic microbes; B, lactate utilizers, particularly *Selenomonas ruminantium* and *Megasphaera elsdenii*; C, *Butyrivibrio fibrisolvens*; D, *Ruminococcus albus*, *S. ruminantium*, *Streptococcus bovis*; E, homoacetogenic bacteria (e.g., *Acetitomaculum ruminis*); F, sulfate-reducing bacteria; G, methanogenic archaea; H, *S. ruminantium* and *Succiniclasticum ruminis*.

2. Protozoa

Because of their large size (100 μm or more in length), protozoa are readily observed microscopically and thus were first described in 1843. Many species of ruminal protozoa have been identified, primarily based on morphological criteria (Hungate, 1966). These can be classified into flagellates and ciliates. Flagellates dominate the ruminal protozoan population of young animals, but they are gradually displaced by the ciliates with aging. The ciliates contain two main groups: the relatively simple holotrichs (e.g., *Isotricha* or *Dasytricha*) or the structurally more complex oligotrichs (e.g., *Entodinium* and *Diplodinium*). The populations of protozoa in the rumen vary widely, but they are usually in the range of 10^2 – 10^6 /mL. These densities are much lower than those of the bacteria; however, because of their large size, the protozoa may in fact represent up to half of the microbial biomass in the rumen (Van Soest, 1994; Jouany and Ushida, 1999).

All of the ruminal protozoa appear to have a strictly fermentative metabolism. Relative to the bacteria, much less is known regarding the physiology and biochemistry of the protozoa for two reasons. First, the protozoa are rather difficult to cultivate in the laboratory (Coleman et al. 1963); ruminal protozoa generally die within hours of transferring mixed rumen microflora into most laboratory culture environments. Second, many protozoa in a variety of habitats contain intracellular or surface-attached bacterial symbionts that engage in syntrophic interactions with their hosts (Fenchel et al., 1977; Vogels et al., 1980). Thus, even when “pure” cultures of protozoa (i.e., single protozoal species in the absence of free-living bacteria) are established and maintained, it is difficult to evaluate the potential contribution of the associated bacteria to the metabolic activities of the protozoa. Some continuous culture systems have successfully maintained protozoa by including a floating-mat matrix that allows the protozoa to resist washout from the vessel at fluid dilution rates similar to those operating in the rumen (Abe and Kurihara, 1984), and it is likely that ruminal protozoa associate in vivo with the ruminal mat or the ruminal wall in a similar manner. Populations of different protozoal species vary among individual animals and within the same animal fed different diets (Faichney et al., 1997).

Because their relatively large size permits microscopic identification of species and behavioral examination, much of our knowledge of these organisms has come from study of samples withdrawn directly from the rumen itself, particularly for comparisons of *faunated* animals (i.e., those having a natural protozoal population) and *defaunated* animals (i.e., those whose protozoal populations have been nearly or completely removed, usually by treatment with chemical agents such as 1,2-dimethyl-5-nitroimidazole or dioctyl sodium sulfosuccinate).

The holotrichs appear to be adapted to growth purely on soluble carbohydrates. On the other hand, microscopic observations have revealed that the entodiniomorphs can engulf plant particles or can attach to the cut ends of plant fiber and

can obtain their nutrition from engulfed starches and apparently some structural polysaccharides as well. Despite the observed associations of protozoa and particulate feeds, it is widely held that the primary ecological role of the entodiniomorph protozoa is the grazing of bacteria (Clarke, 1977; Hobson and Wallace, 1982). Using phase-contrast microscopy, these protozoa can be observed rapidly to ingest free bacteria (i.e., those not attached to plant fiber), and bacterial cell concentrations are approximately 10-fold higher in rumen samples from defaunated than faunated animals. Numerous studies (reviewed by Hobson and Wallace, 1982) have thus far not identified any specific predatory relationships between particular species of protozoa and bacteria. Protozoal grazing of bacteria can reduce the availability of microbial protein to ruminants, which is a notion reflected by lower weight gain in faunated than in defaunated cattle and lambs when tests were conducted with protein-deficient diets—an effect that disappears at higher levels of feed protein. On the other hand, protozoa do appear to provide some benefits to the ruminal microflora (Jouany and Ushida, 1999). By engulfing starch granules and fermenting them more slowly than do bacteria, and by converting lactic acid to the weaker propionic acid, protozoa can help attenuate acidosis and thereby maintain fibrolytic activity of pH-sensitive cellulolytic bacteria.

Protozoa are not the only agents that control bacterial numbers; the rumen maintains substantial populations of bacteriophages (viruses that infect bacteria). Characterization of phage DNAs from rumen contents by pulsed-field electrophoresis (Swain et al., 1996) has revealed that individual animals harbor their own unique populations of phages. Regardless of these differences among host animals, phage populations (as measured by total phage DNA) follow diurnal population cycles related to the populations of the bacterial hosts, with minima and maxima at approximately 2 h and 10–12 h postfeeding, respectively.

3. Fungi

Orpin (1975) demonstrated that several microorganisms originally thought to be flagellated protozoa were actually the zoospore stage of anaerobic fungi. These fungi alternate between a freely motile zoospore stage and a particle-associated thallus. Fungal populations in rumen contents range from 10^4 to 10^5 thallus-forming units per gram of ruminal fluid (Theodorou et al., 1990). Approximately 24 species of these fungi have now been identified on the basis of morphology and 16S rRNA sequences (Trinci et al., 1994). Much of our understanding of the metabolic capabilities of the ruminal fungi has been derived from a single species, *Neocallimastix frontalis*.

Ruminal fungi are strictly anaerobic and have a catabolism based on fermentation of carbohydrate. All described species can digest cellulose and/or hemicelluloses via extracellular enzymes that are produced in low titer but have very high specific activities (Wood et al., 1986). The major products of carbohy-

drate fermentation are acetate, formate, and H_2 with lesser amounts of lactate (primarily the D isomer), CO_2 , and traces of succinate (Borneman et al., 1989). H_2 production occurs via hydrogenosomes, which are intracellular organelles containing high levels of the enzyme hydrogenase. In pure culture, the amounts of soluble and gaseous fermentation products essentially equal the amount of carbohydrate consumed (Borneman et al., 1989); suggesting that the yield of fungal mycelia is very small. This notion is in accord with direct measurements that indicate the ruminal fungi contribute little to the total microbial biomass in the rumen (Faichney et al., 1997). However, the ruminal fungi appear to have specific roles not readily duplicated by bacteria. For example, there is considerable evidence that fungi can attach to and physically disrupt plant tissue (particularly the more recalcitrant tissues such as sclerenchyma and vascular bundles) during growth by penetration through cell walls and expansion into the pit fields between cells (Akin et al., 1989). This physical disruption is thought to make the plant material more easily broken apart during rumination and thus more available to bacteria, which are more efficient at digesting the individual plant cell components such as cellulose. Fungal populations are highest in animals fed diets high in fibrous stem materials; perhaps because of the latter's long ruminal retention time that coincides with the slow growth rate of the fungi.

D. Microbial Fermentations in the Rumen

1. Structural Carbohydrates

Plant cell walls (the fibrous component of most forages) are composed primarily of cellulose, hemicellulose, pectin, and lignin. These polymers are differentially localized into the different layers of the cell wall (Fig. 6). The architecture of the plant cell wall varies greatly with cell type (Harris, 1990). Some cell types such as mesophyll and collenchyma are thin walled and essentially unlignified, and thus are easily digested. Other cell types such as sclerenchyma and xylem tracheary elements display more complex architectures with clearly distinct structures. Groups of these cell types are separated from one another by a middle lamella, which is a highly lignified region that is also rich in pectin. Interior to the middle lamella is the primary wall, the region where wall growth initiates; it is composed primarily of xyloglucans and other hemicelluloses as well as various wall-associated proteins. The secondary wall is laid down later in development and is very thick in mature plants. This region, which contains mostly cellulose with smaller amounts of hemicelluloses and lignin, can be further differentiated into layers (S1, S2, S3) based on the orientation of the cellulose microfibrils.

a. Cellulose Cellulose is the major component of forage fiber, comprising 35–50% of dry weight. Individual cellulose molecules are linear polymers of β -1,4-linked D-glucose molecules. These chainlike molecules are assembled via

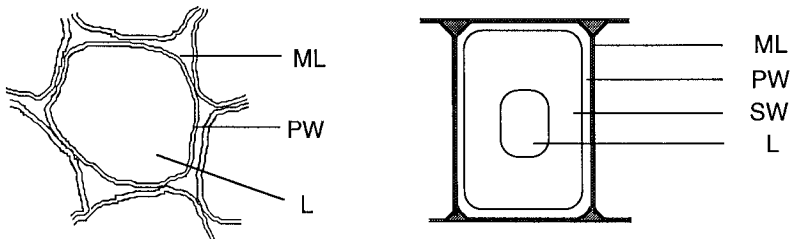

Figure 6 Schematic cross-sectional view of the cell wall of two plant cell types. Abbreviations: ML, middle lamella; PW, primary wall; SW, secondary wall; L, lumen, which in the living cell contains the cytoplasm but is replaced with ruminal fluid during ruminal digestion. (Left panel) Mesophyll cell, characterized by a thin, essentially unligified primary cell wall that is digested rapidly from both the outer and inner (luminal) surface. The middle lamella is thin and unligified, and is usually separated from the middle lamellae of adjacent cells by air spaces. (Right panel) Sclerenchyma cell, characterized by a thin primary wall and thick, secondary walls consisting primarily of cellulose but also containing moderate amounts of hemicelluloses and lignin. Adjacent cells are separated by middle lamellae having a high lignin content. As a result, sclerenchyma cell walls are digested only from the luminal surface outward, and at a relatively slow rate and incomplete extent.

extensive intrachain and interchain hydrogen bonds to form crystalline microfibrils that in turn are bundled into larger cellulose fibers. The packing of cellulose chains within the microfibrils is so tight that even water cannot penetrate. Cellulose fibers thus have a fairly low ratio of exposed surface to volume. Ruminal cellulose digestion appears to follow first-order kinetics with respect to cellulose concentration (i.e., the rate of cellulose digestion is limited by the availability of cellulose rather than by any inherent property of the cellulolytic microbes themselves [Waldo et al., 1972; Van Soest, 1973]).

Although many species of bacteria, fungi, and protozoa have been reported to digest cellulose *in vitro*, only three species of bacteria—*Fibrobacter* (formerly *Bacteroides*) *succinogenes*, *Ruminococcus flavefaciens*, and *R. albus*—are thought to be of major importance in cellulose digestion in the rumen (Dehority, 1993). In pure culture, these three species digest crystalline cellulose as a first-order process with rate constants of 0.05–0.10 h⁻¹ higher than those of any cellulolytic microbes that grow at a similar temperature in nonruminal habitats (Weimer, 1996). These relatively rapid rates of cellulose digestion derive in part from the ability of these species to attach directly to the cellulosic substrate (Fig. 7) and digest the cellulose via cell-bound enzymes; this adherence appears to be a prerequisite to rapid cellulose digestion (Latham et al., 1978; Costerton et al., 1987; Kudo et al., 1987). The cell-associated cellulolytic enzymes are apparently organized into supramolecular complexes resembling the cellulosome, an organ-

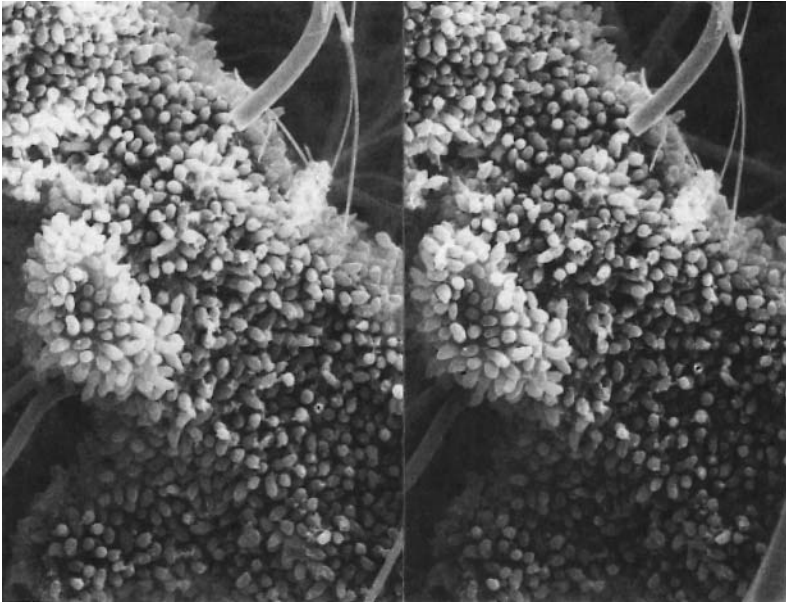

Figure 7 Stereo-optic view of the adherence of the ruminal cellulolytic bacterium *Fibrobacter succinogenes* onto a particle of cellulose. Proper focusing of the eyes or use of a stereo-optic viewer permits a three-dimensional view of the subject. Bar represents 10 μm .

elle that has been well-characterized in the nonruminal thermophilic bacterium *Clostridium thermocellum* (Felix and Ljungdahl, 1993). Although cellulose digestion in the rumen is more rapid than in nonruminal environments, the process is slow relative to the digestion of nonstructural carbohydrates and proteins. Because of this, forages, with their high rumen fill and slow digestion, must be supplemented with more rapidly digested cereal grains to adequately balance energy and protein requirements for high-producing dairy animals (Van Soest, 1994).

The products of cellulose hydrolysis are cellodextrins (short water-soluble β -1,4-glucosides of two to eight glucose units) that are subject to fermentation by both cellulolytic and noncellulolytic species (Russell, 1985). Although the individual cellulolytic species can compete directly for cellulose *in vitro*, it appears that they show differential ability to adhere to different plant cell types (Latham et al., 1978) that may indicate separate but overlapping niches in the rumen. Moreover, it appears that degradation of some plant cell types is delayed by the slow diffusion of nonmotile fibrolytic bacteria into the plant cell lumen (Wilson

and Mertens, 1995). These cell types may provide a niche for motile cellulolytic species such as *Butyrivibrio fibrisolvens*.

The three major cellulolytic species form different fermentation endproducts (Hungate, 1966). *F. succinogenes* produces primarily succinate (an important precursor of propionate) with lesser amounts of acetate. *R. flavefaciens* produces the same acids but with acetate predominating. *R. albus* produces primarily acetate and ethanol in pure culture, but in the rumen it produces mostly acetate and H₂.

Estimation of the relative population sizes of individual cellulolytic species based on both classic determinative schemes (van Gylswyk, 1970) and probes to 16S rRNA (Weimer et al. 1999) suggest that *R. albus* is the most abundant of the three species, but variations in these populations appear to be more substantial among animals than within individual animals fed widely different diets (Fig. 8). Unlike other ruminal bacteria, the ratio of fermentation endproducts formed by each of the predominant cellulolytic species changes little with growth conditions (pH or growth rate). It would thus seem that the relative populations of these three species might contribute to differences in the proportions of acetate and propionate in the rumen. However, because the three species typically comprise less than 4% of the bacterial population in the rumen, their direct contribution to VFA proportions is probably modest.

b. Hemicelluloses Hemicelluloses, a diffuse class of structural carbohydrates that may contain any of a number of monomeric units, can comprise up to one-third of plant cell wall material (Stephen, 1983). Most hemicelluloses contain a main backbone, usually having β -1,4-glycosyl or β -1,3-glycosyl linkages; various types and degrees of branching from the main chain are frequently observed. Because of the multiplicity of hemicellulose structures present in each plant species, it is extremely difficult to isolate pure substrates of known structure, which is a fact that has severely limited the laboratory study of hemicellulose digestion. Among the most abundant of the hemicelluloses are the xylans (unbranched β -1,4-linked polymers of xylose) and the arabinoxylans (xylans containing pendant arabinose side chains). The latter are particularly important, because they are thought to be covalently linked to lignin via cinnamic acid derivatives such as ferulic acid and *p*-coumaric acid (Hatfield, 1993).

Hemicelluloses are hydrolyzed by enzymes that may be extracellular or cell-associated depending on the species (Hespell and Whitehead, 1990). The most active hemicellulose digesters among the ruminal bacterial isolates include *B. fibrisolvens* and the cellulolytic species *R. flavefaciens*, *R. albus*, and *F. succinogenes*; the latter can hydrolyze hemicelluloses in vitro but cannot use the hydrolytic products for growth (Dehority, 1973).

c. Pectic Materials Pectins are polymers of galacturonic acids, some of which also contain substantial amounts of neutral sugars (e.g., arabinose, rhamnose, and galactose). Pectins are more abundant in leaf tissue than in stems, and

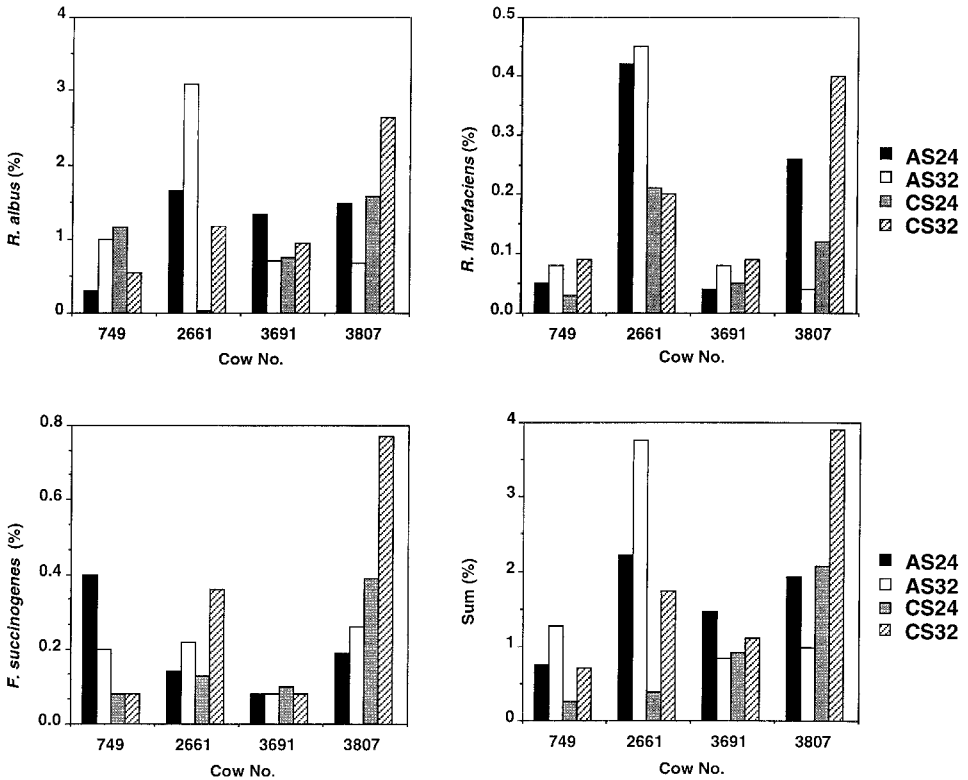

Figure 8 Relative populations of the cellulolytic bacteria *Ruminococcus albus*, *Ruminococcus flavefaciens*, and *Fibrobacter succinogenes* and their sums in the rumens of four cows fed the same four diets. Diets were based on alfalfa silage (AS) or corn silage (CS) at two different levels of fiber (24 or 32% neutral detergent fiber, analyzed after α -amylase treatment). Results are expressed as a fraction of the total bacterial RNA, determined using oligonucleotide probes on samples collected 3 h after feeding. Note differences in the scale of the ordinates. (From Weimer et al., 1999; used by permission of the American Dairy Science Association.)

they are also major components of some byproduct feeds (citrus pulp and fruit processing waste). Although purified pectins from forages are fairly water soluble, they can be considered to be structural carbohydrates, because they are localized in the plant cell wall, particularly in the middle lamellae between cells.

In many respects, pectins are an ideal substrate for ruminal fermentation. They are rapidly digested out of both alfalfa leaves and stems (rate constants of $\sim 0.3 \text{ h}^{-1}$), but unlike starch, pectins do not yield lactic acid as a fermentation

product (Hatfield and Weimer, 1995). The acetate/propionate ratio resulting from fermentation of pectins is in the range of 6–12, which is well above those of most substrates and useful in maintaining milkfat levels in lactating dairy cows. Production of these acids is accompanied by consumption of the galacturonic acid moieties of the pectin, thus assisting in the maintenance of ruminal pH. Several bacterial species have been shown actively to degrade pectin, including *Lachnospira multipara*, *B. fibrisolvens*, *Prevotella* (formerly *Bacteroides*) *ruminicola*, some strains of the genus *Ruminococcus*. (Gradel and Dehority, 1972), and some spirochetes (Ziolecki, 1979).

d. Lignin Lignin, the third major component of the forage cell wall, is a polymer of phenylpropanoid units assembled by a random free radical condensation mechanism during cell wall biosynthesis. Lignin is indigestible under anaerobic conditions and constitutes the bulk of the indigestible material leaving the digestive tract. Moreover, the covalent linkages between lignin (or phenolic acids) and hemicelluloses reduce the digestibility of these forage components (Hatfield, 1993). Electron microscopic studies clearly reveal the recalcitrance of lignified tissues to ruminal digestion (Akin, 1979).

2. Nonstructural Carbohydrates

Nonstructural carbohydrates are those carbohydrates in plant cells that are contained in the cytoplasm or in storage vacuoles. The most abundant of these are the starches (the linear amylose and the branched amylopectin), which are major components of cereal grains (e.g., corn) that comprise much of the diet of high-producing dairy cows.

a. Starch Starches are depolymerized fairly rapidly by extracellular enzymes (amylases and pullulanases) that produce maltodextrins (α -1,4-oligomers of glucose), which are easily converted by other α -glucosidases to glucose and maltose—substrates utilizable by almost all of the carbohydrate-fermenting microbes in the rumen (Hungate, 1966). Consequently, starches have the potential to be completely digestible, although the form of the starch is an important determinant of the rate of digestion. Wheat and barley starch are digested more rapidly than is that of high-moisture corn, which in turn is digested more rapidly than are those of dried corn or dried sorghum. The more rapidly digesting starches have first-order rate constants of digestion of $\sim 0.25 \text{ h}^{-1}$ or above.

Several bacterial species are important in starch digestion, including *Ruminobacter* (formerly *Bacteroides*) *amylophilus*, *B. fibrisolvens*, *P. ruminicola*, *Succinomonas amylolytica*, *Succinivibrio dextrinosolvens*, and *Streptococcus bovis*. The latter species can grow extremely rapidly, particularly on glucose (minimum doubling time is 13 min), and it is the causative agent of lactic acidosis (see Sec. V.D.1). As noted above, some protozoa actively engulf starch granules but do

not appear to produce lactate, thus sequestering these granules from serving as substrates for bacterial lactate production.

Even though diets high in grain content are usually preferred for high-producing cows because of their greater energy density, the presence of an adequate level of fiber in the diet is important for several reasons (Van Soest, 1994). Fiber promotes the long-term health of the ruminant animal by providing a modest rate of carbohydrate digestion and by stimulating rumination and salivation, all of which aid in maintaining ruminal pH within a range desirable for balanced microbial activity. Moreover, fiber in the diet helps the animal avoid milkfat depression, a syndrome resulting primarily from a relative deficiency in acetic acid (a precursor of short chain fatty acids in milk triglycerides) and a relative excess of propionate, which inhibits mobilization of body fat (a precursor of long chain fatty acids in milk triglycerides).

b. Soluble Sugars and Oligomers Many ruminal carbohydrate-fermenting bacteria can utilize most of the different monosaccharides that comprise the various plant polysaccharides (Hungate, 1966): D-glucose, D-xylose, D-galactose, L-arabinose, and D- or L-rhamnose. Many can also use at least some oligosaccharides that are released from the plant cytoplasm by cell wall breakage or that are produced by enzymatic hydrolysis of plant polysaccharides. The latter include cellodextrins (Russell, 1985) and xylooligosaccharides (Cotta, 1993) having seven or fewer glycosyl residues. Concentrations of soluble sugars and their oligomers are maintained at very low levels in the rumen; indicating that biopolymer hydrolysis is the rate-limiting step in digestion and that competition for soluble carbohydrates is probably an important determinant of species composition in the rumen (Russell and Baldwin, 1979a).

In the few cases that have been systematically examined, sugar fermenters have shown dramatic changes in fermentation product ratios with changes in growth rate. Both *S. bovis* (Russell and Hino, 1985) and *Selenomonas ruminantium* (Melville et al., 1988) carry out mixed acid fermentations at low growth rates but nearly homolactic fermentations at growth rates near their maxima.

3. Conversion of Fermentation Intermediate Compounds to Volatile Fatty Acids

Microbial fermentation of both structural and nonstructural polysaccharides produces a mixture of VFAs (usually acetic with some butyric) and other fermentation acids (succinic, lactic, and formic) that are further metabolized by other ruminal microbes. Most of these bacteria require additional growth factors such as amino acids, peptides, and vitamins. Succinate is decarboxylated to propionate (see Fig. 5) by several ruminal species, including the metabolically versatile *Selenomonas ruminantium* and the metabolically specialized *Succiniclasticum ruminis* (van Gylswyk, 1995). Lactate is converted to propionate by several bacterial

species, particularly *S. ruminantium*, *Megasphaera elsdenii*, *Veillonella parvula*, *Anaerovibrio lipolytica*, and some *Propionibacterium* spp. (Mackie and Heath, 1979). Formate is produced in abundance in the rumen both from carbohydrate fermentation and from reduction of carbon dioxide. Formate is rapidly turned over to methane and rarely accumulates (Hungate et al., 1970).

4. H₂ Consumption and Interspecies Hydrogen Transfer

Anaerobic metabolism requires that electrons (reducing equivalents) generated from biological oxidations be transferred to terminal electron acceptors other than oxygen. Most anaerobes that ferment carbohydrates dispose of these electrons by transfer to one or more organic intermediate compounds in the catabolic pathway such as pyruvate (producing lactate), acetyl coenzyme A and acetaldehyde (producing ethanol), and carbon dioxide (producing formate) (see Fig. 5). An alternative electron acceptor is the protons present in all aqueous environments, resulting in production of hydrogen gas (H₂). Disposal of electrons as H₂ is particularly advantageous in that it does not consume carbon-containing intermediate compounds that may be used as biosynthetic precursors. However, production of H₂ is thermodynamically unfavorable unless its production is coupled to its continuous removal by H₂-consuming reactions. This spatial and temporal coupling of H₂ production with H₂ use, referred to as interspecies H₂ transfer, is one of the most important processes in the ecology of anaerobic habitats (Oremland, 1988; Wolin, 1990). Interspecies H₂ transfer benefits both the H₂ consumer, which directly receives its energy source, and the H₂ producer, which can channel more of its substrate into the ATP-yielding production of acetate as a fermentation endproduct (Table 6).

The dominant H₂-consuming reaction in the rumen is the reduction of carbon dioxide to methane gas:



This reaction is carried out by a specialized group of organisms, the methanogens. These organisms are classified with the Archaea, a phylogenetically distinct group that represents an early evolutionary lineage distinct from both eubacteria (true bacteria) and eukaryotes (Woese and Olsen 1986). Methanogens are highly specialized metabolically. Most are restricted in their catabolism to reduction of carbon dioxide to methane, using H₂ as an electron donor, whereas a few have the ability to convert one or more simple organic compounds (methanol, methylamine, formate, or acetate) to methane (Oremland, 1988). Methanol may be periodically available in the rumen from deesterification of pectins. Formate, although not a major ruminal fermentation product, is probably produced by carbon dioxide reduction in amounts sufficient to contribute slightly to ruminal methanogenesis. Acetate, although abundant in the rumen, does not support growth of

Table 6 Fermentation Products from Cellulose in *Ruminococcus albus* Monocultures and *R. albus*/*Methanobreveibacter smithii* Cocultures Illustrating Changes Caused by Interspecies Transfer of H₂ to the Methanogen

Product	mmol/100 mmol Glucose equivalents consumed ^a	
	<i>R. albus</i> alone	<i>R. albus</i> + <i>M. smithii</i>
Ethanol	81	22
Formate	14	0
Acetate	89	151
CO ₂	156	98
H ₂	140	0
CH ₄	0	75 ^b

^a Mean values from continuous culture trials conducted at five different dilution rates.

^b Equivalent to 300 mmol H₂ consumed (at a stoichiometry of 4 mol H₂ consumed per mol CH₄ formed).

Source: Pavlostathis et al., 1990.

“aceticlastic” methanogens, whose growth rates even under ideal conditions are well below dilution rates of both liquids and solids in the rumen. Most methanogens are also autotrophs; that is, they can obtain all of their cell carbon from carbon dioxide. Thus, they can produce microbial protein for the ruminant host without consumption of otherwise useful organic matter.

The energy associated with the reduction of the abundant ruminal carbon dioxide to methane is sufficient to permit both growth of the methanogens and thermodynamic displacement or “pulling” of the reduction of protons to H₂. As a result, the concentration of H₂ in ruminal fluid is very low—normally near 1 μM with only occasional excursions to approximately 20 μM for a few minutes postfeeding (Smolenski and Robinson, 1988). Thus, ruminal methanogenesis, which is viewed unfavorably by nutritionists as a loss of ~8% of the metabolizable energy of the feed, in fact has an important thermodynamic function that permits an adequate rate and extent of carbohydrate fermentation.

Representatives of another group of bacteria, the carbon dioxide–reducing homoacetogens, have been isolated from the rumen and appear to be present at low cell densities. Like the methanogens, these eubacteria can reduce carbon dioxide with H₂, but according to the stoichiometry



The homoacetogens have attracted interest as potential competitors of the methanogens in that they could, in principle, remove fermentatively produced H_2 while at the same time producing acetic acid, an energy source and biosynthetic precursor that the ruminant is well equipped to use (Mackie and Bryant, 1994). Unfortunately, numerous *in vitro* studies have shown that the acetogens are ineffective competitors of the methanogens because of the latter's superior affinity for low concentrations of H_2 . The actual role of the acetogens in the rumen is presently unclear; because this metabolically diverse group is capable of sugar fermentation and removal of methoxyl groups from some feed constituents, its members may fill several niches.

A third group of H_2 utilizers, the sulfate-reducing bacteria, can couple the oxidation of H_2 or certain organic compounds such as lactate to reduction of sulfate (Odom and Singleton, 1993):



Sulfate-reducing bacteria have an affinity for H_2 that even surpasses that of the methanogens; indeed, sulfate reduction is the dominant means of disposal of excess electrons in a sulfate-rich environment (e.g., ocean sediments). Sulfate-reducing bacteria have the unusual capacity to act as H_2 consumers when sulfate is abundant or as H_2 producers (from lactate) when sulfate is absent (Bryant et al., 1977). In the latter situation, the sulfate reducers may be maintained in the rumen by a symbiotic interaction with methanogens wherein the sulfate reducers oxidize lactate to H_2 , whose concentration is kept low by methanogenic activity.

5. Nitrogen Metabolism in the Rumen

a. Protein Degradation Availability of protein to the ruminant is determined by the amount of protein in the feed, its loss in the rumen from microbial fermentation, and the efficiency of microbial protein synthesis that occurs in the rumen. It is estimated that approximately 35–80% of the protein of most forages and grains is degraded by ruminal fermentation and is thus not directly available for intestinal absorption (National Research Council, 1985). Hydrolysis of protein depends on several factors—particularly solubility, which determines both its availability to ruminal microbes and its rate of escape from the rumen. The generalized scheme of protein degradation (see Fig. 9) suggests some similarities to polysaccharide degradations. Proteins are hydrolyzed extracellularly or at the microbial cell surface to produce soluble oligomers that serve as the actual growth substrates. Major proteolytic species in the rumen are *B. fibrisolvans*, *S. bovis*, and *P. ruminicola*. These species also have important roles in carbohydrate fermentation.

The fermentation of amino acids and peptides released from protein hydrolysis is carried out by a number of ruminal species. The most active appear to

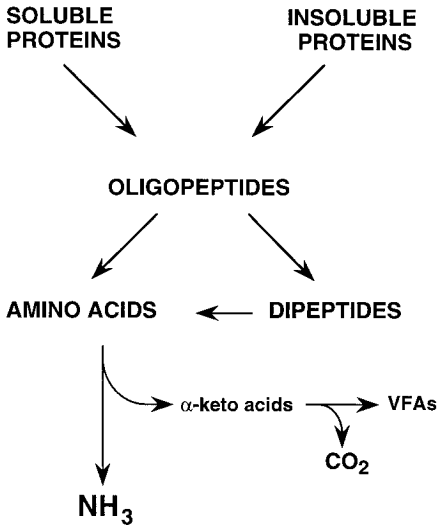

Figure 9 Generalized scheme of protein degradation in the rumen. Both bacteria and protozoa participate in the process. α -Keto acids may be used intracellularly as anabolic intermediate compounds, or decarboxylated to VFAs, which are then exported.

be *Clostridium aminophilum*, *C. sticklandii*, and *Peptostreptococcus anaerobius*. Classic proteolytic species such as *P. ruminicola* appear to be important in protein hydrolysis (Wallace et al., 1999), but they are probably less important in amino acid fermentations, as their rates of ammonia production from amino acids *in vitro* are one or two orders of magnitude lower. Both *C. sticklandii* and *P. anaerobius* are monensin-sensitive, which may explain the protein-sparing effect observed on inclusion of monensin in ruminant diets (Krause and Russell, 1995). Because the concentrations of peptides and free amino acids in the rumen are very low, competition for these substrates among both proteolytic and nonproteolytic microbes is probably intense.

b. Protein Synthesis Whereas the ruminal microflora is responsible for this extensive loss of feed protein, they also contribute up to half of the nitrogen requirements of the animal through synthesis of microbial cell protein, which is hydrolyzed in the abomasum and is subsequently available to the animal (Ørskov, 1982). Protein synthesis by ruminal bacteria occurs primarily from ammonia and organic acids. Indeed, most ruminal bacteria will grow *in vitro* on ammonia as the sole nitrogen source, and many species cannot incorporate significant amounts of amino acids or peptides. Ruminal ammonia is supplied either as a direct product of the ruminal degradation of feed proteins or from urea recycled back into

the rumen by the animal. The organic acids used for protein synthesis are derived from both protein and carbohydrate fermentation. Availability of these organic acids is important for adequate carbohydrate nutrition. For example, the predominant ruminal cellulolytic bacteria require isobutyrate, isovalerate, and 2-methylbutyrate as precursors for intracellular synthesis of the branched chain amino acids valine, leucine, and isoleucine, respectively (Bryant, 1970). This provides an excellent example of both the interactions among different physiological groups of ruminal bacteria and the interaction between energy and protein metabolism in ruminant nutrition.

Because of their impact on production of microbial protein, quantitative aspects of microbial cell yield have received considerable attention. The efficiency of microbial growth (growth yield) varies among species and with growth conditions. Important determinants of growth yield include (a) efficiency of energy conservation (ATP production per unit substrate consumed), (b) ability to import and incorporate preformed organic compounds (e.g., amino acids) into cell material, (c) maintenance energy (the amount of energy that must be expended to maintain cellular constituents and function), and (d) extent to which cells carry out other non-growth-related functions such as polysaccharide storage or wasteful "energy spilling" (Russell and Cook, 1995). A microbe's growth rate also has an impact on cell yield. At low growth rates, yields are depressed somewhat, because a larger portion of the total energy expenditure is devoted to maintenance.

Carbohydrate-fermenting ruminal bacteria have true growth yields (cell yields not corrected for maintenance) within the range of 0.1–0.6 g cells/g carbohydrate; in some instances, these yields may be artificially high if the organisms synthesize storage polysaccharides (Table 7). Cell yields of ruminal bacteria decline when the pH of the environment decreases below 6 (Russell and Dombrowski, 1980). Nevertheless, the growth yields of ruminal bacteria are generally higher than those of anaerobic bacteria native to other anaerobic environments (Hespell, 1979).

Microbial growth yield is affected by growth rate-induced metabolic shifts that alter the ATP yield. For example, increased growth rate on sugars in some species is accompanied by a shift in fermentation products from acetate to lactate and a reduced ATP yield (because conversion of pyruvate to acetate results in formation of one unit of ATP, whereas the conversion of pyruvate to lactate does not) (see Fig. 5). In this instance, the organisms have increased growth rate by selecting a pathway with an inherently high substrate flux (rate of substrate consumed per unit time) at the sacrifice of some ATP yield. By contrast, interspecies H_2 transfer reactions increase the ATP yield of the H_2 producers by allowing more of the organic substrate to be converted to acetate and less to other compounds (e.g., ethanol or lactate) (Wolin, 1990).

Table 7 Growth Yields and Maintenance Coefficients for Several Species of Ruminant Bacteria Grown in Continuous Culture

Bacterium	Substrate	Yg ^a	m ^b	Reference
<i>Butyrivibrio fibrisolvens</i>	Glucose	0.40	0.049	Russell and Baldwin, 1979b
<i>Megasphaera elsdenii</i>	Glucose	0.46	0.187	"
<i>Prevotella ruminicola</i>	Glucose	0.50	0.135	"
<i>Selenomonas ruminantium</i>	Glucose	0.58	0.022	"
<i>Streptococcus bovis</i>	Glucose	0.40	0.150	"
<i>Fibrobacter succinogenes</i>	Cellulose	0.24	0.05	Weimer, 1993
<i>Ruminococcus albus</i>	Cellulose	0.11	0.10	Pavlostathis et al., 1988
	Cellobiose	0.28	0.04	Thurston et al., 1993
<i>Ruminococcus flavefaciens</i>	Cellulose	0.24	0.07	Weimer et al., 1991

^a True growth yield (g cells/g substrate consumed) calculated in the absence of maintenance.

^b Maintenance coefficient (g substrate consumed/g cells/h).

E. Microbial Contributions to Rumen Dysfunction

Under some conditions, the normal ruminal microflora contribute through their activities to certain metabolic diseases (i.e., diseases that are neither infectious nor degenerative and that are preventable by proper feeding and management).

1. Lactic Acidosis

Lactic acidosis is an acute acidification of the rumen resulting from the microbial overproduction of lactic acid (Owens et al., 1998). The condition is often acute in feedlot-finished beef cattle, but subclinical acidosis is also common in high-producing dairy cows (Ostergaard and Sorensen, 1998; Owens et al., 1998). fed diets high in grains, particularly following a switch from diets higher in fiber content. These concentrates are rich in starches and have a relatively poor buffering capacity. The starches are fermented rapidly to lactic acid, primarily by *S. bovis*, a normal rumen inhabitant. At near-neutral pH, *S. bovis* produces primarily formic and acetic acids and only small amounts of lactic acid, but during rapid growth carries out a homolactic fermentation producing the D-isomer. The explosive growth of *S. bovis* outpaces the activities of ruminal lactate consumers (e.g., *S. ruminantium*, *M. elsdenii*, as well as some protozoa). As a result, lactic acid levels may increase from normal values of under 1 mM, to reach 20–300 mM. Because the acidity of lactic acid is 10-fold greater ($pK_a = 3.8$) than for the VFAs—acetic, propionic, and butyric acids—($pK_a = 4.7$ – 4.8), ruminal pH may drop to 4.5 or below. At high lactic acid concentrations, blood and body tissues

attempt to restore proper osmolality to the rumen, leading to a systemic dehydration that may be fatal.

Once acidosis has begun, several factors conspire further to exacerbate the problem (Russell and Hino, 1985). When pH has declined sufficiently, *S. bovis* maintains its homolactic metabolism even as its growth rate decreases. Reduced pH also inhibits degradation of lactate by *S. ruminantium* and *M. elsdenii* and establishes a ruminal niche for other homolactic fermenters such as the facultatively anaerobic lactobacilli.

Even in nonfatal cases, animal health is severely affected. D-lactic acid is absorbed into the bloodstream where it is metabolized more slowly than is the L-isomer. As a result, blood pH decreases and pathologies of other tissues become important (ulceration of the ruminal wall, liver abscess, and foot disorders) (Nocek, 1997; Owens et al., 1998). Low ruminal pH also negatively affects milk production and live weight gain, fiber digestion is inhibited, and feed intake is reduced (Van Soest, 1994).

2. Foamy Bloat

Foamy (or frothy) bloat is an acute condition resulting from formation of a rigid, persistent foam mat at the ruminal liquor surface that prevents normal eructive release of fermentation gases (Clarke and Reid, 1974). It is particularly common in pastured dairy cattle grazing certain lush feeds, especially some legumes (clovers and alfalfa). Gas accumulation results in substantial distension of the reticulorumen. In severe cases, this distension can interfere with respiratory function and produce death within an hour of feeding unless strong remedial action (i.e., puncture of the ruminal wall) is taken. Even in cases of mild bloat, dairy production and animal weight gain may be affected substantially because of reduced feed intake.

Plant factors that have been suggested as contributing to induction of bloat include (a) a high content of certain constituents that may contribute to the structure of the foam mat (soluble proteins, pectin, saponins, or certain classes of lipids) and (b) a high rate of fermentation (usually related to high concentration of soluble sugars and an easily digested cell wall). The amount and characteristics of the plant protein appear to be particularly important. Forages containing high levels of condensed tannins (e.g., birdsfoot trefoil) do not cause bloat, and feeding of condensed tannins usually prevents bloat, apparently because of their capacity to precipitate proteins (Tanner et al., 1995). Animal factors are also involved in bloating; there is a clear genetic predisposition toward bloat resistance and bloat sensitivity (Morris et al., 1997). Recent evidence suggests that bloat-resistant cattle have higher levels of bSP30, a salivary protein of unknown function (Rajan et al., 1996).

The involvement of microbes in bloat is controversial (Clarke and Reid,

1974). Microbes certainly are involved to the extent that the ruminal fermentation is responsible for production of methane and carbon dioxide gases and the acids that reduce the ruminal pH and cause release of carbon dioxide from the ruminal bicarbonate pool. More direct roles of individual species of bacteria and protozoa have been difficult to establish. However, microbial involvement is suggested by two lines of evidence: (a) bloat is routinely and effectively inhibited by controlled release of monensin into the rumen (Cameron and Malmo, 1993) and (b) complete switching of ruminal contents between fistulated cattle having a high or low susceptibility to bloat results in a change of susceptibility that is maintained for approximately 24 h before the animal's natural susceptibility or resistance reasserts itself (Clarke and Reid, 1974).

3. Polioencephalomalacia

Polioencephalomalacia (PEM), also known as cerebrocortical necrosis, is an acute toxicosis that causes destruction of tissues of the central nervous system. It manifests itself in the form of lethargy and sometimes blindness that progress to muscular tremors and coma, with death following within a few days. PEM has been attributed to a thiamin deficiency that may result from elevated levels of thiaminases. More recent data indicate that, in many instances, the condition results from conversion of ingested sulfates to highly toxic hydrogen sulfide (H_2S) by sulfate-reducing bacteria (Gould, 1998) (see Sec. IV.D). Sulfate is not normally a component of dairy rations, but it can be present in high concentrations in some groundwaters and surface waters used for watering stock, particularly in the western United States where the disease was first described and is especially common.

F. Microbes in the Causation and Mitigation of Plant Toxicoses

Many wild forages (and a few cultivated ones) contain compounds that have the potential to poison ruminants (James et al., 1988). In some instances, the toxicosis occurs as a result of microbial conversion of a nontoxic plant constituent to a toxic form. Alternatively, microbes may be involved in detoxifying a poisonous agent in the ingested plant. Specific microorganisms have been identified in three different toxicoses: grass tetany, oxalate poisoning, and mimosine poisoning.

1. Grass Tetany

Grass tetany is a type of hypomagnesemia observed in ruminant animals grazing lush pastures, most commonly during periods of cool, cloudy weather in the spring and autumn. Several clinical forms of the disease have been reported (Littledike et al., 1983). Symptoms of the most common type include nervous and

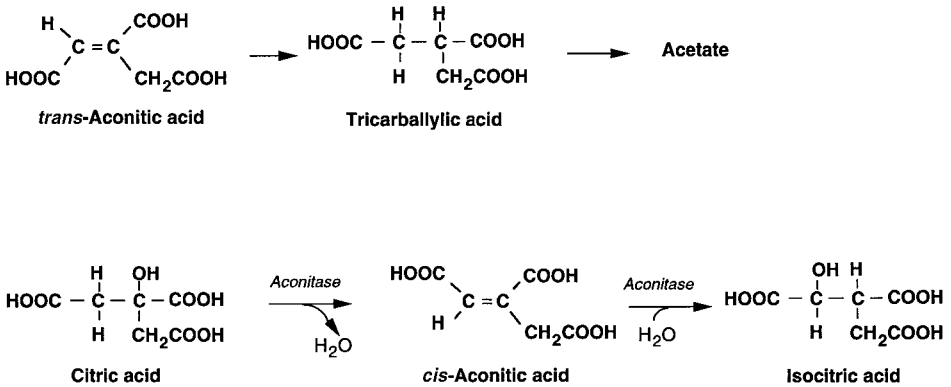

Figure 10 Ruminal metabolism of *trans*-aconitate, a common component of some forages that is thought to be involved in eliciting grass tetany. The reduced intermediate tricarballic acid can chelate Mg and is a potent inhibitor of the enzymatic conversion of the tricarboxylic acid cycle intermediate *cis*-aconitate. Some ruminal bacteria can degrade tricarballic acid to acetate, but only slowly. (From Russell and Forsberg, 1986.)

excited behavior followed within hours or days by strong convulsions that may lead to coma and death. Several causes of magnesium deficiency have been put forward, including inhibition of Mg uptake by K and formation of MgNH_4PO_4 precipitates. Alternative, more feasible explanations revolve around *trans*-aconitate (TAA) (Russell and Forsberg, 1986). This compound, an isomer of the tricarboxylic acid cycle intermediate *cis*-aconitate, represents up to 7% of the dry weight of some grasses. Although it is itself a potent chelator of Mg^{2+} in vitro, TAA is also reduced by some ruminal microbes (particularly *S. ruminantium*) to tricarballic acid. This compound is readily absorbed into the bloodstream and acts as both a strong chelator of Mg^{2+} and as a structural analog of citrate that inhibits the enzymatic conversion of citrate to isocitrate, a key reaction sequence of the oxidative tricarboxylic acid (TCA) cycle (Fig. 10). At least one ruminal bacterium, *Acidaminococcus fermentans*, can detoxify TAA by stoichiometric conversion to acetate (Cook et al., 1994).

2. Oxalate Poisoning

Oxalate is widely distributed in plants and in some wild forages (e.g., halogeton) and may comprise several percentage of dry weight. Because oxalate is a potent chelator of calcium (and to a lesser extent magnesium), ingestion of these forages can cause hypocalcemia. Oxalate can be metabolized by a dismutation reaction



carried out by *Oxalobacter formigenes*, a nutritionally specialized gram-negative bacterium unable to use other substrates as energy sources (Allison et al., 1985).

3. Mimosine Poisoning

Mimosine, a nonprotein amino acid, is present in some tropical forages, particularly the shrub *Leucaena leucocephala*. In the rumen, the pyrridone group of the compound is released and metabolized to the toxic goiterogen 3,4-dihydroxypyridine. Resistance to mimosine poisoning is dependent on the ruminal bacterium *Synergistes jonesii* (Allison et al., 1992). This species has been found in goats from Hawaii and Indonesia, and it has been successfully transferred to ruminants in Australia (Jones and Megarrrity, 1986) and the United States (Hammond et al., 1989) where it also confers resistance to mimosine poisoning. In the latter case, the bacterium was maintained in the rumen over a winter during which *Leucaena* was not fed in the diet of the host cattle; maintenance probably resulted from the bacterium's ability to compete successfully with the native microflora for arginine and a few other amino acids that can serve as growth substrates for this nutritionally specialized bacterium. *S. jonesii* is unique among ruminal bacteria in that it exhibits a specific geographical distribution.

G. Potential for Altering the Ruminal Fermentation and the Composition of Milk

The ruminal symbiosis has developed over eons in response to selective pressures on both the animal and the ruminal microflora (Van Soest, 1994). The high levels of production achieved in the animal industry have come in part by the use of feeding and management strategies that have placed new challenges on the ruminal microflora (e.g., feeding of starches that induce lactic acidosis). Numerous proposals have been put forward to "improve" the ruminal fermentation. These proposals have aimed at one or more objectives: (a) increase the rate and extent of digestion of fiber, (b) improve nitrogen availability (either by decreasing the rate and extent of degradation of feed protein or by improving microbial protein synthesis), (c) redirect the microbial fermentation to enhance the amounts or ratios of products that serve as precursors for milk or meat, and (d) detoxify feed or forage components. The microbial ecological principles associated with such proposed alterations have been reviewed by Weimer (1998).

Increasing the rate and extent of fiber digestion is complicated by the nature of the plant cell wall (see Sec. IV.D.1). Introduction of enhanced fibrolytic capabilities by genetic engineering has been touted as a means to improve fiber digestion (Russell and Wilson, 1988). Under normal conditions, cellulose digestion in the rumen appears to be limited by cellulose accessibility and not by properties of the microflora (Waldo et al., 1972; Van Soest, 1973). However, under conditions of low pH most fibrolytic species—particularly the cellulolytics—have lim-

ited activity. Introduction of fibrolytic activities into acid-tolerant but nonfibrolytic species may be a viable route to improve fiber digestion as long as the introduced organism can maintain itself in the rumen both at low pH (when competition for fiber may be minimal) and at more normal pH (when competition for fiber would be more intense). A second approach to enhancing the ruminal digestion of fiber involves improvements in plant breeding to produce plant varieties having cell wall structures of improved digestibility (Buxton and Casler, 1993).

Reducing the ruminal degradation of feed protein can be accomplished by a variety of means, including chemical (formaldehyde) or physical (heat) treatment or incorporation of tannins into the diet (Broderick et al., 1991). Alternative means of controlling the microbes—either reducing their proteolytic activity or increasing microbial growth yield—have shown little promise to this point.

Controlling the ratios of fermentation endproducts is already exploited in the beef industry through the use of monensin and other ionophores. These compounds are more effective against gram-positive than gram-negative bacteria. Because these groups contain some of the more notable producers of acetate and propionate, respectively, treatment with monensin has several effects, including increasing ruminal propionate and decreasing ruminal acetate and the acetate/propionate ratio. This effect, along with an increase in intake, lead to improved gluconeogenesis, feed efficiency, and body weight gain in beef animals (summarized by Goodrich et al., 1984). Effects in heifers have been more equivocal, although monensin does significantly decrease the age at breeding and at calving (Meinert et al., 1992). The opposite strategy to shift the fermentation balance toward acetate production may be useful for dairy animals, as the reduction in ruminal acetate/propionate ratio that occurs in some diets is associated with an undesirable reduction in milkfat levels (Shaver et al., 1986; Woodford and Murphy, 1988; Klusmeyer et al., 1990).

There is considerable interest in redirecting ruminal H_2 away from production of methane and toward acetate (Mackie and Bryant, 1994). Although this has not been accomplished practically, recent evidence suggests that yeast may enhance the competitiveness of acetogenic bacteria for H_2 , although this effect has to this point only been demonstrated *in vitro* at H_2 concentrations well above those found in the rumen (Chaucheyras et al., 1995). Yeasts are an example of a direct-fed microbial agent (or probiotic, a natural strain of microbe that improves digestive function). Incorporation of some yeasts and fungi into ruminant diets improves fiber digestion and milk production (Williams et al., 1991; Wohlt et al., 1991), although the mechanism remains unclear (Martin and Nisbet, 1992). Bacteria may also be useful as probiotics. For example, it has been shown recently that lactic acidosis can be avoided in sheep abruptly switched to a grain diet if the lactate-utilizing bacteria *S. ruminantium* and *M. elsdenii* are fed as a probiotic (Wiryawan and Brooker, 1995). The use of probiotics in the dairy industry is

expanding, although they have not assumed the same status as in the poultry industry, where bacterial probiotics are widely used to prevent colonization of young chicks with *Salmonella* infection.

As discussed (see Sec. IV.F.3), implantation of mimosine-degrading bacteria has been proven to confer resistance of ruminant animals to mimosine toxicity. Once established in an animal, these bacteria apparently can be readily transferred to other herd members through normal close contact (Quirk et al., 1988). The probiotic use of other detoxifying organisms holds promise for more productive utilization of toxigenic forages in ruminant diets.

Several milkfat components that have been implicated in having the ability to prevent or reduce the incidence of cancer. Two of these components, butyrate and conjugated linoleic acid, are produced primarily by ruminal bacteria. Butyrate is produced by many common ruminal bacteria (see Table 5). It is maintained at concentrations of several millimolar in the rumen and is efficiently absorbed across the ruminal wall. Among its various metabolic fates is its incorporation into milkfat, where it accounts for 7.5–13.0 mol% of the fatty acids (Parodi, 1996). Butyric acid has been demonstrated to have a variety of anticarcinogenic activities (Parodi, 1996), and its production in the colon of humans on high-fiber diets has been implicated in reducing colon cancer (McIntyre et al., 1993).

Conjugated linoleic acids (CLAs) are a class of isomers of linoleic acid having conjugated double bonds. CLAs, of which milk fat is the richest natural source, have been reported to have anticarcinogenic, antiatherogenic, and immunomodulating activities (reviewed by Parodi, 1996). The most abundant CLA isomer, *cis*-9, *trans*-11-octadecadienoic acid, is produced as an intermediate compound in the hydrogenation of linoleic acid by the ruminal fibrolytic bacterium *B. fibrisolvens* (Kepler et al., 1966). This synthetic activity is in accord with the higher levels of milk CLAs observed in pastured cows whose diets are particularly rich in fiber (Dhiman et al. 1996; Kelley et al., 1998). It appears that CLAs can also be produced by the gut microflora of monogastric animals, as normal rats contain higher amounts of CLAs in their tissues than do germ-free rats (Chin et al., 1994). The higher levels of the linoleic acid substrate that are present in the rumen, purportedly due to hydrolysis of the ruminal bacteria themselves, are thought to explain the unusually high production of CLAs by ruminant animals (Chin et al., 1994).

H. Fermentations in the Hindgut

Hindgut fermentations received very little attention until development of intestinal cannulae permitted quantitative studies. It was long assumed that the extent of digestion that occurs in the hindgut is only a small fraction of that of the total tract. However, the fraction of total tract digestibility that occurs in the hindgut varies with several factors, particularly feed intake (Tamminga, 1993). In cattle

fed at high intakes, up to 37% of the total energy digestion can occur in the cecum and large intestine (Zinn and Owens, 1981). Digestion in the hindgut should be of greater importance in high-producing ruminants, which in general have both high levels of feed intake and ruminal pH values sufficiently low to depress fiber digestion and some other microbial activities in the rumen. The microbiology of the hindgut fermentation in ruminants has not been extensively explored, but in many respects probably resembles that of monogastric animals.

V. INFECTIOUS DISEASES OF DAIRY ANIMALS

Dairy animals are subject to numerous infections by different species of pathogenic microorganisms. All groups of microbes—bacteria, fungi, viruses, protozoa, and even algae—contain species that are pathogenic to dairy animals. The diseases caused by these organisms are tremendously costly to the dairy producer. Even if animals survive infection, the producer can suffer severe economic hardship in treatment costs, lost production of milk or calves, and disposal of infected milk or milk tainted by antibiotic residues. Quantitative data on the effects of bacterial infections on milk yield and milk composition are now available for several infectious diseases.

It is beyond the scope of this text to provide more than a general summary of the more important diseases and their causative agents. A listing of the more common bacterial diseases is provided in Table 8. For more detail, the reader is referred to veterinary texts, particularly the recent two-volume treatise of Coetzer et al. (1994).

A. Mastitis

Mastitis is an inflammation of the mammary gland that can affect virtually any mammalian species, but it is especially important in dairy animals because of their large udder sizes, high milk production rates, and extensive handling of teats. Mastitis remains the most costly disease of the dairy animal (DeGraves and Fetrow, 1993). Economic losses are well over \$2 billion annually in the United States alone. Most of the economic losses associated with the disease result from the decrease in milk output and in the discard of milk from infected animals. When the costs associated with additional labor, veterinary fees, and therapeutic agents are added, the total represents 10–11% of the productive capacity of the dairy cattle industry.

Mastitis is classified as clinical or subclinical based on its severity, cause, and the characteristics of the exudate fluid; additional subclassifications can also be made (dePreez and Giesecke, 1994). Clinical mastitis is accompanied by macroscopic signs of disease in the animal (e.g., fever, swelling of the udders) and

Table 8 Major Bacterial Diseases of Cattle

Disease	Causative agent
Anthrax	<i>Bacillus anthracis</i>
Botulism	<i>Clostridium botulinum</i>
Bovine tuberculosis	<i>Mycobacterium bovis</i>
Brucellosis	<i>Brucella abortus</i>
Clostridial enterotoxemia	<i>Clostridium perfringens</i> types B, C, and D
Fusobacterium infections	<i>Fusobacterium necrophorum</i>
Gas gangrene	<i>Clostridium chauvoei</i> , <i>C. novyi</i> , <i>C. septicum</i>
Genital campylobacteriosis	<i>Campylobacter</i> sp.
Haemophilus somnus complex	<i>Haemophilus somnus</i>
Leptospirosis	<i>Leptospira pomona</i>
Listeriosis	<i>Listeria monocytogenes</i>
Mastitis	Many agents (See Table 9)
Paratuberculosis	<i>Mycobacterium paratuberculosis</i>
Salmonellosis	<i>Salmonella</i> serovars
Tetanus	<i>Clostridium tetani</i>

in the milk. Clinical mastitis appears to cause similar reductions in yield in high- and low-yielding herds (Firat, 1993).

Subclinical mastitis can only be detected by laboratory methods, and is most commonly revealed by routine microscopic counts of somatic cells ($>4 \times 10^5$ cells/mL, usually leukocytes) in the milk (Auldism and Hubble, 1998). If mastitis is caused by infection, the causative agent can be observed and often identified at the same time. Even subclinical mastitis is usually associated with a decrease in milk volume. In a recent review of the literature, Hortet and Seegers (1998) have calculated that each doubling of somatic cell count above 5×10^4 cells/mL reduces milk yield by 0.4 kg/day in primiparous cows and 0.6 kg/day in multiparous cows.

Mastitis may have any of several causes, chief among which are bacterial infections. Although the udder is constantly exposed to potential pathogens, development of mastitis requires both that the agent be sufficiently numerous and virulent and that the host be susceptible to infection. Susceptibility is a complex function of the animal and management practices, including milking technique. From an epidemiological standpoint, mastitis is regarded as *contagious* if it is transmitted from infected animals (i.e., almost exclusively by the milking process) or *environmental* if the pathogen's reservoir and the source of infection is the animal's environment. Numerous species of bacteria have been implicated in causing mastitis (Table 9), but the importance of individual species has changed with changes in dairy practice (Fox and Gay, 1993). *Streptococcus aga-*

Table 9 Causative Agents of Bovine Mastitis

Common agents:

*Staphylococcus aureus**Streptococcus* spp. (especially *S. agalactiae*, *S. dysgalactiae*, *S. uberis*)Coliform bacteria (especially *Escherichia coli*, *Citrobacter freundii*, *Enterobacter* spp., and *Klebsiella* spp.)*Actinomyces pyogenes*

Less common agents:

*Listeria monocytogenes**Pseudomonas aeruginosa**Mycoplasma bovis**Corynebacterium bovis* and *C. diphtheriae**Nocardia* spp. (especially *N. asteroides*)Coagulase-negative *Staphylococcus* spp. (many species)*Bacillus cereus**Brucella abortus**Clostridium perfringens**Coxiella burnetii**Leptospira* spp.*Mycobacterium bovis**Serratia marcescens**Prototheca zopfii* (alga)

Source: duPreez and Giesecke, 1994.

lactiae was once the most common causative agent, but it has been displaced over the past few decades by *Staphylococcus aureus*. Several genera of the family Mollicutes (bacteria having very simple genomes and lacking a cell wall), including *Mycoplasma* spp., appear to have a growing involvement as causative agents of mastitis, as does *Listeria monocytogenes*.

Mastitic infection can occur via the blood or by trauma to the udder, but it far more commonly occurs via the streak canal of the teat. Although the arrangement of cells and folding of tissues within the teat provide considerable defense against invading pathogens, this defense weakens in cows with age or under conditions of high production. Infection, regardless of route, results in a suite of host responses. Among these are phagocytosis by polymorphonuclear neutrophils (Craven and Williams, 1985), production of antibodies which resist bacterial adherence to epithelial cells, and neutralization of toxins.

Infectious mastitis results in changes, which are often dramatic, in milk composition (du Preez and Giesecke, 1994; Hortet and Seegers, 1998). Fat content is reduced to below 3%, chloride is increased 1.5-fold, and lactose decreases substantially (often by 5-fold or more), because the pathogen uses this substrate

for growth. Total protein content may show only slight changes, but the amount of casein may be reduced at the expense of protein from antibodies, somatic cells, and bacterial cells. In addition to its nutritional inferiority, mastitic milk is visually and organoleptically unappealing because of the presence of microbial polymers, the release of free fatty acids (as a result of lipase activity), and a reduced lactose and increased chloride content.

S. aureus, now the most common agent of clinical mastitis, is a gram-positive nonmotile coccus that grows in characteristic aggregates resembling bunches of grapes. The virulence of *S. aureus* appears to result from a variety of characteristics, including production of extracellular polysaccharide (EPS) capsule, ability to involute into the epithelial cells, production of exotoxins (e.g., leukocidin and coagulase), and causation of tissue necrosis. Chronic mastitic infections are often characterized by bacterial growth in the form of adherent colonies embedded within a large EPS matrix (Brown et al., 1988). Most *S. aureus* isolates that have been recovered from mastitic milk show a characteristic “diffuse colony morphology” resulting from the constitutive or inducible production of the EPS capsule (Baselga et al., 1994). The specific EPS is normally determined by direct serotyping of capsular antigens. Although the EPS is apparently involved in adhesion of bacterial cells to ducts and alveoli in the mammary gland, it is not yet clear if the EPS is involved in the initial adhesion event or more firmly attaches the bacteria in place following initial adhesion of the cells to the mammary tissue. Regardless, these matrices provide the bacteria with resistance to antibiotic treatment (because of inaccessibility) and phagocytosis (because of the substantial size of the cellular complex).

Much has been written regarding the potential increase in mastitis that may arise from treatment of cows with bovine somatotropin (BST). Although BST treatments undoubtedly increase the prevalence of mastitis, there is considerable evidence (reviewed by Burton et al., 1994) that this effect is not the result of a reduced immunological capacity to resist infection, but instead is caused by extra stress placed on udders from increased milk volume. Thus, the enhanced levels of mastitis are similar to those observed in cows geared to high production by any of a number of feeding and management strategies regardless of exogenous BST supplementation.

B. Tuberculosis

Tuberculosis is a contagious, chronic disease resulting from infection by species of the genus *Mycobacterium*. Tuberculosis has been one of the most pervasive and destructive diseases of both humans and animals throughout all of recorded history, and Robert Koch's isolation in 1882 of *M. tuberculosis* (the main causative agent in humans) is one the greatest achievements of clinical microbiology.

Bovine tuberculosis is caused by *M. bovis*, an organism with an unusually wide host range that includes not only cattle but humans and other primates along with many domestic animals (e.g., dogs, cats, pigs, and goats) (O'Reilly and Daborn, 1995). Reservoirs of tuberculosis are also maintained in many wild animals, including bison (*Bison bison*) and elk (*Cervus elaphus*) in North America; badgers (*Meles meles*) in England; and opossum (*Trichosurus velpecula*) in New Zealand. These wild species represent a potential source of infection of domesticated ruminant animals, or they more commonly provide sufficient exposure to elicit positive tuberculin tests that complicate the undertaking of prophylactic measures to control the disease. In most nonbovine species, the infection is not self-maintaining; even in sheep and goats, the disease is rare.

M. bovis infections of humans through the drinking of milk from infected dairy cows was a serious public health problem early in the 20th century, and this spearheaded the impetus for compulsory disinfection of the U.S. public milk supply by pasteurization (Myers and Steele, 1969). These and other advances in sanitation, along with aggressive culling of infected animals, has largely controlled bovine tuberculosis in many parts of the world, but it remains an impending threat to dairy producers.

Bovine tuberculosis is normally spread among herds as a result of the introduction of infected cattle into noninfected herds. Infections are generally spread among animals by inhalation of aerosol microdroplets (2–5 μm diameter; small enough to reach the lung alveoli) released by infected animals when sneezing and coughing; however, transmission is also thought to be possible via feces and various body fluids that may contain the bacilli. The spread of the disease within a herd is largely governed by the susceptibility of its cows, which in turn depends on management conditions (e.g., stock density, the overall health of the herd, and control measures adopted by the producer) and by the relative number of young stock. Control measures are complicated by the generally chronic, subclinical nature of the disease. In most cases, the lesions are small in size and number and clinical signs are often not readily apparent. In clinical forms of the disease, the lymph nodes are the most common target, with the lungs being less often affected. Other organs are affected only rarely, and usually as a result of spread through the bloodstream; included among these are infections of the udder (discussed earlier as a form of mastitis). The pathogenesis of the disease has been recently reviewed by Neill et al. (1994).

As a genus, the mycobacteria are straight or slightly curved rods that lack motility and the ability to form endospores. Because of their high content of lipids, the cells do not stain readily by the Gram staining method, although electron microscopy reveals that the cell walls are clearly gram-positive. The lipids are responsible for the characteristic property of acid fastness (i.e., resistance to decolorization by an acid-alcohol mixture following initial staining by heated carbol fuchsin), a characteristic sufficiently rare among bacteria as to constitute

Table 10 Phenotypic Characteristics Differentiating *Mycobacterium bovis* from *M. tuberculosis*

Characteristic	<i>M. bovis</i>	<i>M. tuberculosis</i>
Primary host	Cattle	Human
Colony morphology	Moist, smooth, flat	Dry, wrinkled
Colony development	≥ 3 weeks	10–14 days
Nitrate reduction	Negative	Positive
Niacin production	Negative	Positive
Glycerol	Inhibits growth	Stimulates growth
Pyrazinamide	Resistant	Sensitive
Thiophene-2-carboxylic acid hydrazide	Sensitive	Resistant

strong preliminary evidence for a mycobacterial infection. The lipids are also responsible for the considerable resistance of the mycobacteria toward chemical agents, and this property is used to advantage in the isolation of mycobacteria from clinical samples. Tissues are ground in a saline solution and pretreated for 30 min or less with 1 M of NaOH or 2% HCl before neutralization, centrifugation (to concentrate the cells), and plating onto solid media.

The mycobacteria are notoriously slow growers in culture media, including the preferred rich diagnostic media such as Löwenstein-Jensen, Ogawa, Dubos, or Middlebrook 7H10 medium. Even in these media, growth is often not detected before 3 or 4 weeks of incubation at 37°C. Clinical and veterinary microbiologists should recognize that, in addition to host specificity, *M. bovis* and *M. tuberculosis* display several physiological differences (Table 10). The difficulty of culturing these organisms has led to attempts to develop alternate diagnostic tests, and evidence suggests that enzyme-linked immunosorbent assays (ELISAs), when used in combination with standard tuberculin tests, improve the diagnosis of infection (Gaborick et al., 1996).

Elimination of tuberculosis in infected herds is usually accomplished by either immediate slaughter of infected animals or by gradual isolation of infected animals until all of the remaining cattle are free of tuberculosis.

C. Paratuberculosis

Paratuberculosis (Johne's disease) is a chronic and infectious disease of the intestinal tract caused by *Mycobacterium paratuberculosis* (Huchzermeyer et al., 1994). The disease affects both domestic and wild ruminants, and it causes a severe diarrhea and debilitating weight loss. Infection normally occurs either congenitally or via ingestion by young animals of feces from infected animals. Older animals may largely resist infection, because mycobacteria do not survive well

in the fully developed rumen. In infected animals, the incubation period varies enormously, but clinical signs of the disease apparently require multiple exposures and are not normally manifested for 3–5 years. Even in totally infected herds, however, only a small percentage of the animals may display clinical signs, whereas the remaining, subclinically infected animals may or may not be actively shedding the agent in their feces. Subclinical infections result in approximately a 4% reduction in milk yields without significant changes in fat or protein content (Nordlund et al., 1996).

As a result of the low percentage of clinical cases in infected herds, the mortality rate within the herd is fairly low (Blood et al., 1989). The long incubation period and subclinical nature of the disease makes antibiotic therapy difficult and fairly ineffective in clinical cases. Vaccination is effective only in conjunction with a strong emphasis on animal hygiene, and must be used only in tuberculosis-free herds, because the vaccine interferes with serological or allergic tests. In humans, *M. paratuberculosis* is thought to cause Crohn's disease.

M. paratuberculosis is a short, thin, gram-positive, acid-fast rod connected by intercellular filaments that give the organism an aggregated appearance under microscopic observation. Like the mycobacterial agents of bovine tuberculosis, *M. paratuberculosis* grows extremely slowly, even in the preferred Herrold's egg yolk medium, and requires exogenous mycobactin (a class of lipid-soluble cell wall components) for growth. Because of this slow growth, successful isolation of the bacterium requires that feces or intestinal tissue be macerated and exposed briefly to chemical agents (e.g., NaOH or various disinfectants) to eliminate other bacterial contaminants.

D. *Brucella* Infections

Bacteria of the genus *Brucella* include several infectious disease agents, including *Brucella abortus*, which causes bovine brucellosis (contagious abortion) in cattle, bison, and other bovines; *B. ovis*, which causes epididimitis and orchitis in sheep; and *B. melitensis*, which causes abortion and orchitis in sheep and goats. *B. abortus* can also be transmitted to humans, in whom it causes undulant fever; this debilitating and often misdiagnosed disease (Latter, 1984) most often afflicts workers having extensive contact with cattle, but it has been reported in some cases to result from contamination of unpasteurized dairy products from infected animals (Bishop et al., 1994).

Members of the genus *Brucella* are gram-negative, nonmotile, nonsporulating cells having a coccus or coccobacillus morphology. They are fairly fastidious in their growth requirements; most require for growth complex media containing serum and an atmosphere enriched to 5–10% carbon dioxide. One distinguishing feature of *B. abortus* is its use of erythritol, a four-carbon sugar alcohol, as an

energy source. This substrate is abundant in the uterus of pregnant cows, stimulating the localization of the organism at that site.

Because the disease is often subclinical in nature, an extensive battery of tests is often employed to detect *Brucella* infections (Bishop et al., 1994). These include direct culture of the agent, detection of specific antibodies, and detection of allergic responses to the agent. Various inocula are used for direct culture, particularly uterine discharge, colostrum, or milk (from live animals); supramammary lymph nodes (from slaughtered animals); and lung, stomach, and liver (from aborted fetuses and full-term calves). The simplest test is the milk ring test in which killed *Brucella* cells are added to a fresh milk sample. If the milk is infected, a bluish ring will form around the cream line as the cream rises. Other tests involve the reaction of serum antibodies with antigens stained with Rose Bengal, the reaction of milkfat antibodies with stained *B. abortus* cells, or the complement fixation test, which is regarded as the most definitive of the antibody tests (Huber and Nicoletti, 1986). Recent application of the polymerase chain reaction to amplify species-specific repetitive DNA sequences shows promise for identifying infected animals and tracing outbreaks (Tcherneva et al., 1996).

Removal of infected stock is used to control outbreaks, but this strategy is complicated by the latency of the disease (Ter Huurne et al., 1993). Vaccination with avirulent strains of *B. abortus* is somewhat effective in controlling infection, particularly in heifers (Nicoletti, 1984; Al-Khalaf et al., 1992). Such vaccination enhances resistance to the disease but does not provide absolute immunity.

E. Enteropathogenic *Escherichia coli*

Several serotypes of *E. coli*, particularly O157:H7, cause severe intestinal illnesses in humans that can include bloody diarrhea and hemolytic uremic syndrome, and they are responsible for an estimated 400,000 infections and 250 deaths annually in the United States (Armstrong et al., 1996). *E. coli* O157:H7 has an unusually low infectious dose (as few as 10 cells), and it owes its potent virulence to a combination of its ability to invade gut mucosa, an outer membrane containing a lipid A endotoxin, and its production of a Shiga-like protein exotoxin (Bettleheim, 1996). *E. coli* infections usually result from consuming contaminated, inadequately prepared foods (e.g., undercooked meat, fruit juices, and vegetables).

Cattle are considered a major reservoir of *E. coli* O157:H7 (Bettleheim, 1996). The bacteria proliferate primarily in the hindgut and are shed in the feces where they may remain viable for months (Wang et al., 1996). Because of this, numerous quantitative studies have examined the prevalence of *E. coli* O157:H7 in cattle herds. Early work suggested that *E. coli* O157:H7 was fairly uncommon in dairy cows. A survey of 1131 dairy cattle and 659 calves in Ontario, Canada, for Shiga-like toxin-producing strains of *E. coli* (Wilson et al., 1992) revealed

that ~10% of all cows and 25% of all calves were infected; in some herds, the infection rates were 60 and 100%, respectively. However, few of the 206 verotoxin-producing strains were serovars that had been isolated from humans, and none were serovar O157:H7. In contrast, although 5 of 60 dairy herds in Washington state had cows with fecal O157:H7 present, overall prevalence (only 10 of 3570 cows) was low (Hancock et al., 1994). More recent work, using more sensitive methods based on immunomagnetic beads (Chapman et al., 1994), reveals that O157:H7 is much more prevalent than previously suspected and may exceed 30% in dairy herds (Chapman et al., 1997; Mechie et al., 1997). Differences in O157:H7 strains both among and within herds have been noted at the genetic level using restriction endonuclease digestion profiles (Faith et al., 1996).

Because *E. coli* O157:H7 can successfully colonize human gut epithelia only if the bacteria can survive transit through the acidic gastric stomach, and because acid resistance is inducible, the preinfection environment may have a major role in the pathogenicity of *E. coli* O157:H7. There is strong evidence that diets high in concentrates, which promote low pH and high concentrations of volatile fatty acids in the bovine colon, result in fecal shedding of strain O157:H7 and other acid-resistant strains in their most virulent (i.e., acid-resistant) state (reviewed by Russell et al., 2000). Diez-Gonzalez et al. (1997) observed that feces from grain-fed animals contained higher densities of acid-resistant *E. coli*, and that these numbers decreased on a switch to a hay diet. Moreover, a recent study with beef cattle that naturally shed strain O157:H7 indicates that dietary management (particularly reducing the amount of grain feeding) can greatly reduce the prevalence of O157:H7 shedding (Keen et al., 1999).

F. Viral Diseases

Most of the major classes of viruses contain strains that are pathogenic to dairy animals (Table 11). The bovine leukemia virus is the most serious in the United States, where 10–30% of dairy herds may be infected. In tropical countries, rinderpest and hoof-and-mouth disease are probably the most serious viral infections of cattle. Unlike many bacterial infections of ruminant animals that can also be transmitted to humans, most viruses that infect ruminant animals have narrower host specificities and do not normally infect humans. Exceptions include the following: some of the Orthomyxoviridae (influenza viruses) and Flaviviridae, which cause mild influenza-like diseases, and the parainfluenza type 3 virus, which causes a pneumonia-like condition. The more serious exceptions include the Bunyaviridae, causative agents of Rift Valley fever and Crimean-Congo hemorrhagic fever. The former is, in humans, a mild influenza with various and occasionally fatal complications, whereas the latter is a serious disease with a mortality rate in humans of approximately 30% (Swanepol, 1994).

Table 11 Viral Agents of Disease in Cattle

Viral family	Disease
Adenoviridae	Adenovirus infection ^a
Bunyaviridae	Crimean-Congo hemorrhagic fever Rift Valley fever
Coronaviridae	Coronavirus infection
Flaviviridae	Weselbron disease Louping-ill
Herpesviridae	Bovine herpes mammilitis Malignant catarrhal fever Pseudorabies
Paramyxoviridae	Bovine respiratory syncytial virus ^a Parainfluenza type 3 (shipping fever) ^a Rinderpest
Parvoviridae	Bovine parvovirus infection
Picornaviridae	Bovine rhinovirus infection Foot-and-mouth disease
Retroviridae	Bovine leucosis

^a Also affects goats, as do caprine arthritis-encephalitis and peste de petits ruminants.

Source: Adapted from Coetzer et al., 1994.

The lack of response of viruses to antibiotics makes treatment of viral diseases particularly problematic, although progress is being made toward the development of new vaccines (e.g., for Rift Valley fever [Morril et al., 1997]) and new antiviral compounds (e.g., polyoxometalates effective against respiratory syncytial virus [Barnard et al., 1997]). Regardless of these efforts, dairy producers should continue to maintain both animal hygiene and good management techniques to ward off viral infections.

Viral infections have variable effects on milk production. Bovine diarrhea virus has been reported to have severe economic impact in dairy herds both through lower milk yield and more severe disease in calves (Moerman et al., 1994). Bovine respiratory syncytial virus has no significant effect on milk production (Van der Poel et al., 1993). Bovine leukemia virus has been reported in one case to decrease milk yield and in another to increase yield (Rulka et al., 1993). Dairy cattle having a genetic potential for high milk production have a greater tendency toward infection with bovine leukemia virus, which probably explains why cows having subclinical infections with this virus sometimes produce more milk (albeit with lower milkfat content) than do uninfected animals in the same herd (Wu et al., 1989).

G. Bovine Spongiform Encephalopathy

Bovine spongiform encephalopathy (BSE), commonly known as “mad cow disease,” is a transmissible slow-acting fatal neurodegenerative disease whose symptoms include abnormal gait, nervousness, and ataxia. The disease was first identified in Britain in 1987 (Wells et al., 1987), and by mid-1998 the number of confirmed cases in that country had reached 173,915 (Patterson and Painter, 1999). Epidemiological studies suggest that approximately 903,000 cattle were infected between 1974 and 1995; apparently from consuming offal mixed into the feed following a change in processing methods by renderers. Most infected animals were beef cattle that had been slaughtered before demonstration of symptoms, and it is suspected that approximately 446,000 infected animals entered the human food chain. BSE was also widely distributed in dairy cows, and it is thought to have infected 59% of British dairy herds. The epidemic has dissipated after changes in feeding practices and the forced destruction of hundreds of thousands of infected animals; however, infected cattle have recently been identified in several other European countries.

Evidence has accumulated that BSE and other transmissible spongiform encephalopathies (TSEs), which have been identified in many domestic and wild mammalian species, are caused by *prions*, an abnormal form of PrP, a cell surface glycoprotein (Prusiner, 1997). The abnormal form, designated PrP^{Sc}, can convert PrP to additional PrP^{Sc}. Because PrP^{Sc} is resistant to proteases, it accumulates to concentrations that cause degeneration of the brain and reticuloendothelial tissues by a yet unknown mechanism. There is evidence that (a) BSE may have arisen from scrapie, a TSE of sheep and goats and (b) BSE may have been transferred in several cases to humans, resulting in a variant Creutzfeldt-Jakob disease (reviewed in Patterson and Painter, 1999).

REFERENCES

- Abe M, Kurihara Y. Long-term cultivation of certain rumen protozoa in a continuous fermentation system supplemented with sponge materials. *J Appl Bacteriol* 56:201–213, 1984.
- Akin DE. Microscopic evaluation of forage digestion by rumen microorganisms—a review. *J Anim Sci* 48:701–710, 1979.
- Akin DE, Lyon CE, Windham WR, Rigsby LL. Physical degradation of lignified stem tissues by ruminal fungi. *Appl Environ Microbiol* 55:611–616, 1989.
- Al-Khalaf SAS, Mohamad BT, Nicoletti P. Control of brucellosis in Kuwait by vaccination of cattle, sheep and goats with *Brucella abortus* strain 19 or *Brucella melitensis* strain Rev1. *Trop Anim Health Prod* 24:45–49, 1992.
- Allison MJ, Dawson KA, Mayberry WR, Foss JG. *Oxalobacter formigenes* gen. nov.,

- sp. nov.: oxalate-degrading anaerobes that inhabit the gastrointestinal tract. Arch Microbiol 141:1–7, 1985.
- Allison, MJ, Mayberry WR, McSweeney CS, Stahl DA. *Synergistes jonesii*, gen. nov., sp. nov.: a rumen bacterium that degrades toxic pyridinediols. Syst Appl Microbiol 15:522–529, 1992.
- Applebaum RS, Brackett RE, Wiseman DW, Marth EH. Response of dairy cows to dietary aflatoxin: feed intake and yield, toxin content, and quality of milk of cows treated with pure and impure aflatoxin. J Dairy Sci 65:1503–1508, 1982.
- Armstrong GL, Hollinsworth J, Morris JG Jr. Emerging foodborne pathogens: *Escherichia coli* O157:H7 as a model of entry of a new pathogen into the food supply of the developed world. Epidemiol Rev 18:29–51, 1996.
- Auldust MJ, Hubble IE. Effect of mastitis on raw milk and dairy products. Aust J Dairy Technol 53:28–36, 1998.
- Barnard DL, Hill CL, Gage T, Matheson JE, Huffman JH, Sidwell RW, Otto MI, Schinazi RF. Potent inhibition of respiratory syncytial virus by polyoxometalates of several classes. Antivir Res 34:27–37, 1997.
- Baselga R, Albizu I, Amorena B. *Staphylococcus aureus* and slime as virulence factors in ruminant mastitis. A review. Vet Microbiol 39:195–204, 1994.
- Baumgardt BR, Byer WJ, Jumah HF, Krueger CR. Digestibility in the steer, goat, and artificial rumen as measures of forage nutritive value. J Dairy Sci 47:160–164, 1964.
- Bettleheim, KA. Enterohaemorrhagic *Escherichia coli*: a new problem, an old group of organisms. Aust Vet J 73:20–26, 1996.
- Bishop GC, Bosman PP, Herr S. Bovine brucellosis, In: Coetzer JAW, Thomson GR, Tustin RC, eds. Infectious Diseases of Livestock, with Special Reference to Southern Africa. Cape Town, South Africa: Oxford University Press, 1994, pp 1056–1066.
- Blood DC, Radostits OM, Henderson JA. Diseases Caused by Bacteria. Vol IV. Veterinary Medicine. 7th ed. London: Baillière, Tindall, and Cox, 1989.
- Bondi A. Animal Nutrition. London: J Wiley, 1983, pp 437–475.
- Borneman WS, Akin DE, Ljungdahl LG. Fermentation products and plant cell wall degrading enzymes produced by monocentric and polycentric anaerobic rumen fungi. Appl Environ Microbiol 55:1066–1073, 1989.
- Broderick GA, Wallace RJ, Ørskov ER. Control of the rate and extent of protein degradation, In: Physiological Aspects of Digestion and Metabolism in Ruminants: Proceedings of the Seventh International Symposium on Ruminant Physiology. New York: Academic Press, 1991, pp 541–592.
- Brown MRW, Allison DG, Gilbert P. Resistance of bacterial biofilms to antibiotics: a growth-rate related effect? J Antimicrob Chemother 22:777–783, 1988.
- Bryant MP. Normal flora—rumen bacteria. Am J Clin Nutr 23:1440–1450, 1970.
- Bryant MP, Campbell LL, Reddy CA, Crabill MR. Growth of *Desulfovibrio* in lactate and ethanol media low in sulfate in association with H₂-utilizing methanogenic bacteria. Appl Environ Microbiol 33:1162–1169, 1977.
- Burton JL, McBride BW, Block E, Glimm DR, Kennelly JJ. A review of bovine growth hormone. Can J Anim Sci 74:167–201, 1994.

- Buxton DR, Casler MD. Environmental and genetic effects on cell wall composition and digestibility. In: Jung HG, Buxton DR, Hatfield RD, Ralph J, eds. Forage Cell Wall Structure and Digestibility. Madison, WI: American Society for Agronomy-Crop Science Society of America-Soil Science Society of America, 1993, pp 685–714.
- Cameron R, Malmo J. A survey of the efficacy of sustained-release monensin capsules in the control of bloat in dairy cattle. *Aust Vet J* 70:1–4, 1993.
- Chapman PA, Wright DJ, Siddons DA. A comparison of immunomagnetic separation and direct culture for the isolation of verotoxin-producing *Escherichia coli* from bovine faeces. *J Med Microbiol* 40:424–427, 1994.
- Chapman PA, Siddons CA, Cerdan Malo AT, Harkin MA. A 1-year study of *Escherichia coli* in cattle, sheep, pigs and poultry. *Epidemiol Infect* 119:245–250, 1997.
- Chaucheyras F, Fonty G, Bertin G, Gouet P. In vitro H₂ utilization by a ruminal acetogenic bacterium alone or in association with an archaea methanogen is stimulated by a probiotic strain of *Saccharomyces cerevisiae*. *Appl Environ Microbiol* 61:3466–3467, 1995.
- Chin SF, Storkson JM, Liu W, Albright KJ, Pariza MW. Conjugated linoleic acid (9,11- and 10,12-octadecadienoic acid) is produced in conventional but not germ-free rats fed linoleic acid. *J Nutr* 124:694–701, 1994.
- Church DC, ed. The Ruminant Animal. Englewood Cliffs, NJ: Prentice-Hall, 1988, p 564.
- Clarke RTG. Protozoa in the rumen ecosystem, In: Clarke RTG, Bauchop T, eds. Microbial Ecology of the Gut. New York: Academic Press, 1977, pp 251–275.
- Clarke RTG, Reid CSW. Foamy bloat of cattle: a review. *J Dairy Sci* 57:753–785, 1974.
- Coetzer JAW, Thomson GR, Tustin RC, eds. Infectious Diseases of Livestock, with Special Reference to Southern Africa. Cape Town, South Africa: Oxford University Press, 1994.
- Coleman GS. The growth and metabolism of rumen ciliate protozoa, In: Dubos R, Kessler A, eds. Symbiotic Associations. 13th Symposium of the Society of General Microbiologists. Cambridge, UK: Cambridge Univ. Press, 1963, pp 298–324.
- Cook GM, Rainey FA, Chen G, Stackebrandt E, Russell JB. Emendation of the description of *Acidaminococcus fermentans*, a *trans*-aconitate and citrate-oxidizing bacterium. *Int J Syst Bacteriol* 44:576–578, 1994.
- Costerton JW, Cheng, K-J., Geesey GG, Ladd TI, Nickel DC, Dasgupta M, Marrie TJ. Bacterial biofilms in nature and disease. *Ann Rev Microbiol* 41:435–464, 1987.
- Cotta MA. Utilization of xylooligosaccharides by selected ruminal bacteria. *Appl Environ Microbiol* 59:3557–3563, 1993.
- Craven N, Williams MR. Defences of the bovine mammary gland against infection and prospects for their enhancement. *Vet Immunol Immunopathol* 10:71–127, 1985.
- DeGraves FJ, Fetrow J. Economics of mastitis and mastitis control. *Vet Clin North Am Food Animal Pract* 9:421–434, 1993.
- Dehority BA. Carbon dioxide requirement of various species of rumen bacteria. *J Bacteriol* 105:70–76, 1971.
- Dehority BA. Hemicellulose degradation by rumen bacteria. *Fed Proc* 32:1819–1825, 1973.
- Dehority BA. Microbial ecology of cell wall degradation. In: Jung HG, Buxton DR, Hatfield RD, Ralph J, eds. Forage Cell Wall Structure and Digestibility. Madison, WI:

- American Society for Agronomy-Crop Science Society of America-Soil Science Society of America, 1993, pp 425–454.
- Devendra C, Coop IE. Ecology and distribution. In: Coop IE, ed. World Animal Science. C. Production-System Approach. Vol 1, Sheep and Goat Production. Amsterdam: Elsevier, 1982, p 8.
- Dhiman TR, Anand GR, Satter LD, Pariza M. Conjugated linoleic acid content of milk from cows fed different diets. *J Dairy Sci* 79(Suppl 1):137, 1996.
- Diez-Gonzalez F, Russell JB. Grain feeding and the dissemination of acid-resistant *Escherichia coli* from cattle. *Science* 281:1666–1668, 1998.
- duPreez JH, Giesecke WH. Mastitis. In: Coetzer JAW, Thomson GR, Tustin RC, eds. Infectious Diseases of Livestock, with Special Reference to Southern Africa. Cape Town, South Africa: Oxford University Press, 1994, pp 1564–1595.
- Ellis JE, Williams AG, Lloyd D. Oxygen consumption by ruminal microorganisms: protozoal and bacterial contributions. *Appl Environ Microbiol* 55:2583–2587, 1989.
- Faichney G, Poncet C, Lassalas J, Jouany P, Millet L, Dore J, Brownlee AG. Effect of concentrate in a hay diet on the contribution of anaerobic fungi, protozoa and bacteria to nitrogen in rumen and duodenal digesta in sheep. *Anim Feed Sci Technol* 64:193–213, 1997.
- Faith NG, Shere JA, Brosch R, Arnold KW, Ansay SE, Lee MS, Luchansky JB, Kaspar CW. Prevalence and clonal nature of *Escherichia coli* O157:H7 on dairy farms in Wisconsin. *Appl Environ Microbiol* 62:1519–1525, 1996.
- Felix CR, Ljungdahl LG. The cellulosome: the exocellular organelle of *Clostridium*. *Ann Rev Microbiol* 47:791–819, 1993.
- Fenchel T, Perry T, Thane A. Anaerobiosis and symbiosis with bacteria in free-living ciliates. *J Protozool* 24:154–163, 1977.
- Firat MZ. An investigation into the effects of clinical mastitis on milk yield in dairy cows. *Livestock Prod Sci* 36:311–321, 1993.
- Food and Agricultural Organization. Production Yearbook, Vol. 52. FAO Statistics Series No. 112, Rome, Italy: Food and Agricultural Organization, United Nations, 1999, pp 186–216.
- Fox LK, Gay JM. Contagious mastitis. *Vet Clin North Am Food Animal Pract* 9:475–488, 1993.
- Gaborick CM, Salman MD, Ellis RP, Triantis J. Evaluation of a five antigen ELISA for diagnosis of tuberculosis in cattle and Cervidae. *J Am Vet Med Assoc* 209:962–966, 1996.
- Goodrich RD, Garrett JE, Gast DR, Kirick MA, Larson DA, Meiske JC. Influence of monensin on the performance of cattle. *J Anim Sci* 58:1484–1498, 1984.
- Gould DH. Polioencephalomalacia. *J Anim Sci* 76:309–314, 1998.
- Gradel CM, Dehority BA. Fermentation of isolated pectin and pectin from intact forages by pure cultures of rumen bacteria. *Appl Microbiol* 23:332–340, 1972.
- Guettler MV, Rumler D, Jain MK. *Actinobacillus succinogenes* sp. nov., a novel succinic acid producing strain from the bovine rumen. *Int J Syst Bacteriol* 49:207–216, 1999.
- Hammond AC, Allison MJ, Williams MJ, Prine GM, Bates DB. Prevention of leucaena toxicosis of cattle in Florida by ruminal inoculation with 3-hydroxy-4-(1H)-pyridone-degrading bacteria. *Am J Vet Res* 50:2176–2180, 1989.
- Hancock DD, Besser TE, Kinsel ML, Tarr PI, Rice DH, Paros MG. The prevalence of

- Escherichia coli* O157:H7 in dairy and beef cattle in Washington State. *Epidemiol Infect* 113:199–207, 1994.
- Harris PJ. Plant cell wall structure and development, In: Akin DE, Ljungdahl LG, Wilson JR, Harris PJ, eds. *Microbial and Plant Opportunities to Improve Lignocellulose Utilization in Ruminants*. New York: Elsevier, 1990, pp 71–90.
- Hatfield, RD. Cell wall polysaccharide interactions and degradability. In: Jung HG, Buxton DR, Hatfield RD, Ralph J, eds. *Forage Cell Wall Structure and Digestibility*. Madison, WI: American Society for Agronomy-Crop Science Society of America-Soil Science Society of America, 1993, pp 285–314.
- Hatfield RD, Weimer PJ. Degradation characteristics of isolated and in situ cell wall lumen pectic polysaccharides by mixed ruminal microbes. *J Sci Food Agric* 69:185–196, 1995.
- Hespehl RB. Efficiency of growth by ruminal bacteria. *Fed Proc* 38:2707–2712, 1979.
- Hespehl RB, Whitehead TR. Physiology and genetics of xylan degradation by gastrointestinal tract bacteria. *J Dairy Sci* 73:3013–3022, 1990.
- Ho YW, Abdullah N. The role of rumen fungi in fiber digestion: a review. *Asian Austr J Anim Sci* 12:104–112, 1999.
- Hobson PN, Wallace RJ. Microbial ecology and activities in the rumen: part I. *CRC Crit Rev Microbiol* 9:165–225, 1982.
- Hoover WH, Kincaid CR, Varga GA, Thayne WV, Junkins LL Jr. Effects of solids and liquid flows on fermentation in continuous cultures. IV. pH and dilution rate. *J Anim Sci* 58:692–699, 1983.
- Hortet P, Seegers H. Calculated milk production losses associated with elevated somatic cell counts in dairy cows: review and critical discussion. *Vet Res (Paris)* 29:497–510, 1998.
- Huber JD, Nicoletti P. Comparison of the results of card, Rivanol, complement-fixation, and milk ring tests with the isolation rate of *Brucella abortus* from cattle. *Am J Vet Res* 47:1529–1531, 1986.
- Huchzermeyer HFAK, Brückner GK, Bastianello SS. Paratuberculosis. In: Coetzer JAW, Thomson GR, Tustin RC, eds. *Infectious Diseases of Livestock, with Special Reference to Southern Africa*. Cape Town, South Africa: Oxford University Press, 1994, pp 1445–1457.
- Hungate RE. *The Rumen and Its Microbes*. New York: Academic Press, 1966.
- Hungate RE, Smith W, Bauchop T, Yu I, Rabinowitz JC. Formate as an intermediate in the rumen fermentation. *J Bacteriol* 102:389–397, 1970.
- James LF, Ralphs MH, Nielsen DB. *The Ecology and Economic Impact of Poisonous Plants on Livestock Production*. Boulder, CO: Westview Press, 1988.
- Jones GM, Larsen RR, Javed AH, Donefer E, Gaudreau JM. Voluntary intake and nutrient digestion of forages by goats and sheep. *J Anim Sci* 34:830–838, 1972.
- Jones RJ, Megarrity RG. Successful transfer of DHP-degrading bacteria from Hawaiian goats to Australian ruminants to overcome the toxicity of *Leucaena*. *Aust Vet J* 63:259–262, 1986.
- Jouany JP, Ushida I. The role of protozoa in feed digestion: a review. *Asian Austr J Anim Sci* 12:113–128, 1999.
- Keen JE, Ulrich GA, Elder RO. Effect of hay- and grain-based diets on the fecal shedding of naturally-acquired enterohemorrhagic *E. coli* (EHEC) O157:H7 in beef feedlot

- cattle. Abstr 86, 80th Conference of Research Workers in Animal Diseases, Chicago, 1999.
- Kelly ML, Kolver ES, Bauman DE, Van Amburgh ME, Muller LD. Effect of intake of pasture on concentrations of conjugated linoleic acid in milk of lactating cows. *J Dairy Sci* 81:1630–1636, 1998.
- Kepler CR, Hiron KP, McNeill JJ, Tove SB. Intermediates and products in the biohydrogenation of linoleic acid by *Butyrivibrio fibrisolvens*. *J Biol Chem* 241:1350–1354, 1966.
- Kiermeier F, Weiss G, Behringer G, Miller M, Ranfft K. Presence and content of aflatoxin M₁ in milk supplied to a dairy. *Z Lebens Unters Forsch* 163:71–74, 1977.
- Kistner A, Kornelius JH. A small-scale, three-vessel, continuous culture system for quantitative studies of plant fibre degradation by anaerobic bacteria. *J Microbiol Methods* 12:173–182, 1990.
- Klusmeyer TH, Cameron MR, McCoy GC, Clark JH. Effects of feed processing and frequency of feeding on ruminal fermentation, milk production, and milk composition. *J Dairy Sci* 73:3538–3543, 1990.
- Krause DO, Russell JB. An rRNA approach for assessing the role of obligate amino acid-fermenting bacteria in ruminal amino acid deamination. *Appl Environ Microbiol* 62:815–821, 1996.
- Kudo H, Cheng K-J, Costerton JW. Electron microscopic study of the methylcellulose-mediated detachment of cellulolytic rumen bacteria from cellulose fibers. *Can J Microbiol* 33:267–272, 1987.
- Lafont P, Lafont J, Mousset J, Frayssinet C. Etude de la contamination du lait de vache lors de l'ingestion de faibles quantités d'aflatoxine. *Ann Nutr Alim* 34:699–708, 1980.
- Latham MJ, Brooker BE, Pettipher GL, Harris PJ. Adhesion of *Bacteroides succinogenes* in pure culture and in the presence of *Ruminococcus flavefaciens* to cell walls in leaves of perennial ryegrass (*Lolium perenne*). *Appl Environ Microbiol* 35:1166–1173, 1978.
- Latter M. On having brucellosis. In: Freed DLJ, ed. *Health Hazards of Milk*. London: Bailliére Tindall, 1984, pp xvi–xvii.
- Littledike ET, Steudemann JA, Wilkinson SR, Horst RL. Grass tetany syndrome. In: Fontenot JP, Bunce GE, Webb KE Jr, Allen VG, eds. *Role of Magnesium in Animal Nutrition*. Blacksburg, VA: Virginia Polytechnic Institute and State University, 1983, pp 1–49.
- Mackie RI, Bryant MP. Acetogenesis and the rumen: syntrophic relationships. In: Drake HL, ed. *Acetogenesis*. New York: Chapman and Hall, 1994, pp 331–364.
- Mackie RI, Heath S. Enumeration and isolation of lactate-utilizing bacteria from the rumen of sheep. *Appl Environ Microbiol* 38:416–421, 1979.
- Martin SA, Nisbet DJ. Effect of direct-fed microbials on rumen microbial fermentation. *J Dairy Sci* 75:1736–1744, 1992.
- McIntyre A, Gibson PR, Young GP. Butyrate production from dietary fibre and protection against large bowel cancer in a rat model. *Gut* 34:386–391, 1993.
- Mead L, Jones GA. Isolation and presumptive identification of adherent epithelial bacteria ('epimural' bacteria) from the ovine rumen wall. *Appl Environ Microbiol* 41:1020–1028, 1981.

- Mechie SC, Chapman PA, Siddons SA. A fifteen month study of *Escherichia coli* O157:H7 in a dairy herd. *Epidemiol Infect* 118:17–25, 1997.
- Meinert RA, Yang, C-MJ, Heinrichs AJ, Varga GA. Effect of monensin on growth, reproductive performance, and estimated body composition in Holstein heifers. *J Dairy Sci* 75:257–261, 1992.
- Melville SB, Michel TA, Macy JM. Regulation of carbon flow in *Selenomonas ruminantium* grown in glucose-limited continuous culture. *J Bacteriol* 170:5305–5311, 1988.
- Mertens DR. Biological effects of mycotoxins upon rumen function and lactating dairy cows. Proceedings of the Symposium on Interaction of Mycotoxins in Animal Production. Washington, DC: National Academy of Sciences, 1979.
- Moerman A, Straver PJ, DeJong MCM, Quak J, Baanvinger T, Van Oirschot JT. Clinical consequences of a bovine virus diarrhoea virus infection in a dairy herd: a longitudinal study. *Vet Q* 16:115–119, 1994.
- Morril JC, Mebus CA, Peters CJ. Safety and efficacy of a mutagen-attenuated Rift Valley fever virus vaccine in cattle. *Am J Vet Res* 58:1104–1109, 1997.
- Morris CA, Cullen NG, Geertsma HG. Genetic studies of bloat susceptibility in cattle. *Proc NZ Soc Anim Prod* 57:19–21, 1997.
- Myers JA, Steele JH. *Bovine Tuberculosis Control in Man and Animals*. St. Louis, MO: Warren H. Green, 1969.
- National Research Council. *Ruminant Nitrogen Usage*. Washington, DC: National Academy Press, 1985.
- Neill SD, Pollock JM, Bryson DB, Hanna J. Pathogenesis of *Mycobacterium bovis* infection in cattle. *Vet Microbiol* 40:41–52, 1994.
- Nicoletti P. Vaccination of cattle with *Brucella abortus* strain 19 administered by differing routes and doses. *Vaccine* 2:133–135, 1984.
- Nocek JE. Bovine acidosis: implications of laminitis. *J Dairy Sci* 80:1005–1028, 1997.
- Nordlund KV, Goodger WJ, Pelletier J, Collins MT. Association between subclinical paratuberculosis and milk production, milk components, and somatic cell counts in dairy herds. *J Am Vet Med Assoc* 208:1872–1876, 1996.
- Odenyo AA, Mackie RI, Stahl DA, White BA. The use of 16S rRNA-targeted oligonucleotide probes to study competition between ruminal fibrolytic bacteria: pure culture studies with cellulose and alkaline peroxide-treated wheat straw. *Appl Environ Microbiol* 60:3697–3703, 1994.
- Odom JM, Singleton R Jr, eds. *Sulfate-Reducing Bacteria: Current Perspectives*. New York: Springer-Verlag, 1993.
- Office of the Federal Register. Code of Federal Regulations, Title 21, Section 131.110. Washington, DC: National Archives and Records Administration, 1995.
- O'Reilly LM, Daborn CJ. The epidemiology of *Mycobacterium bovis* infection in animals and man. *Tubercle Lung Dis* 76(Suppl 1):1–46, 1995.
- Oremland RS. Biogeochemistry of methanogenic bacteria, In: Zehnder AJB, ed. *Biology of Anaerobic Microorganisms*. New York: J Wiley, 1988, pp 641–705.
- Orpin CG. Studies on the rumen flagellate, *Neocallimastix frontalis*. *J Gen Microbiol* 91: 249–262, 1975.
- Ørskov, ER. *Protein Nutrition in Ruminants*. New York: Academic Press, 1982.

- Ostergaard S, Sorensen JT. A review of the feeding-health-production complex in a dairy herd. *Prev Vet Med* 36:109–129, 1998.
- Owens FN, Secrist DS, Hill WJ, Gill DR. Acidosis in cattle: a review. *J Anim Sci* 76: 275–286, 1998.
- Patterson DSP, Glancy EM, Roberts BA. The carryover of aflatoxin M₁ into the milk of cows fed rations containing a low concentration of aflatoxin B₁. *Food Cosmet Toxicol* 18:35–37, 1980.
- Patterson WJ, Painter MJ. Bovine spongiform encephalopathy and new variant Creutzfeldt-Jakob disease: an overview. *Comm Dis Pub Health* 2:5–13, 1999.
- Parodi PW. Milk fat components: possible chemopreventive agents for cancer and other diseases. *Aust J Dairy Technol* 51:24–32, 1996.
- Pavlostathis SG, Miller TL, Wolin MJ. Kinetics of insoluble cellulose fermentation by continuous cultures of *Ruminococcus albus*. *Appl Environ Microbiol* 54:2660–2663, 1988.
- Pavlostathis SG, Miller TL, Wolin MJ. Cellulose fermentation by continuous cultures of *Ruminococcus albus* and *Methanobrevibacter smithii*. *Appl Microbiol Biotechnol* 33:109–116, 1990.
- Prusiner SB. Prion diseases and the BSE crisis. *Science* 278:245–251, 1997.
- Quirk MF, Bushell JJ, Jones RJ, Megarrrity RG, Butler KL. Liveweight gains on leucaena and native grass after dosing cattle with rumen bacteria capable of degrading DHP, a ruminal metabolite from leucaena. *J Agric Sci* 111:165–170, 1988.
- Rajan GH, Morris CA, Carruthers VR, Wilkins RJ, Wheeler TT. The relative abundance of a salivary protein, bSP30, is correlated with susceptibility to bloat in cattle herds selected for high or low bloat susceptibility. *Anim Genetics* 27:407–414, 1996.
- Rulka J, Dacko J, Kozaczynska B, Reichert M, Kimentowski S. Milk production in cows infected with enzootic bovine leukemia virus evaluated on the basis of ELISA and AGAD tests. *Med Weterynaryjna* 49:408–411, 1993.
- Russell JB. Fermentation of cellodextrins by cellulolytic and noncellulolytic rumen bacteria. *Appl Environ Microbiol* 49:572–576, 1985.
- Russell JB, Baldwin RL. Comparison of substrate affinities among several rumen bacteria: a possible determinant of rumen bacterial competition. *Appl Environ Microbiol* 37: 531–536, 1979a.
- Russell JB, Baldwin RL. Comparison of maintenance energy expenditures and growth yields among several rumen bacteria grown in continuous culture. *Appl Environ Microbiol* 37:537–543, 1979b.
- Russell JB, Cook GM. Energetics of bacterial growth: balance of anabolic and catabolic reactions. *Microbiol Rev* 59:48–62, 1995.
- Russell JB, Dombrowski DB. Effect of pH on the efficiency of growth by pure cultures of rumen bacteria in continuous culture. *Appl Environ Microbiol* 39:604–610, 1980.
- Russell JB, Forsberg N. Production of tricarballic acid by rumen microorganisms and its potential toxicity in ruminant tissue metabolism. *Br J Nutr* 56:153–162, 1986.
- Russell JB, Hino T. Regulation of lactate production in *Streptococcus bovis*: a spiraling effect that contributes to rumen acidosis. *J Dairy Sci* 68:1712–1721, 1985.
- Russell JB, Wilson DB. Potential opportunities and problems for genetically engineered rumen organisms. *J Nutr* 118:271–279, 1988.

- Russell JB, Diez-Gonzalez F, Jarvis GN. Potential effect of cattle diets on the transmission of pathogenic *Escherichia coli* to humans. *Microbes Infect* 2:45–53, 2000.
- Shaver, RD, Nytes AJ, Satter LD, Jorgensen NA. Influence of amount of feed intake and forage physical form on digestion and passage of prebloom alfalfa hay in dairy cows. *J Dairy Sci* 69:1545–1559, 1986.
- Slater JH. Microbial populations and community dynamics. In: Lynch JM, Hobbie JE, eds., *Microorganisms in Action: Concepts and Applications in Microbial Ecology*. 2nd ed. Oxford, UK: Blackwell, 1988, pp 51–74.
- Smolenski WJ, Robinson JA. In situ rumen hydrogen concentrations in steers fed eight times daily, measured using a mercury reduction detector. *FEMS Microbial Ecol* 53:95–100, 1988.
- Stahl DA, Flesher B, Mansfield HR, Montgomery L. Use of phylogenetically-based hybridization probes for studies of ruminal microbial ecology. *Appl Environ Microbiol* 54:1079–1084, 1988.
- Stephen AM. Other plant polysaccharides, In: Aspinall, GO, ed. *The Polysaccharides*. Vol 2. New York: Academic Press, 1983, pp 97–193.
- Swain RA, Nolan JV, Klieve, AV. Natural variability and diurnal fluctuations within the bacteriophage population of the rumen. *Appl Environ Microbiol* 62:994–997, 1996.
- Swanepol R. Crimean-Congo haemorrhagic fever, In: Coetzer JAW, Thomson GR, Tustin RC, eds. *Infectious Diseases of Livestock, with Special Reference to Southern Africa*. Cape Town, South Africa: Oxford University Press, 1994, pp 722–729.
- Tammaing S. Influence of feeding management on ruminant fiber digestibility. In: Jung HG, Buxton DR, Hatfield RD, Ralph J, eds. *Forage Cell Wall Structure and Digestibility*. Madison, WI: American Society for Agronomy-Crop Science Society of America-Soil Science Society of America, 1993, pp 571–602.
- Tanner GJ, Moate PJ, Davis LH, Laby RH, Yuguang L, and Larkin PJ. Proanthocyanidins (condensed tannins) destabilise plant protein foams in a dose dependent manner. *Aust J Agric Res* 46:1101–1109, 1995.
- Tcherneva E., Rijpens N, Naydensky C, Herman L. Repetitive element sequence based polymerase chain reaction for typing of *Brucella* strains. *Vet Microbiol* 51:169–178, 1996.
- Ter Huurne AAHM, Deijer M, Dijkerman NA. The latency of *Brucella abortus* causes a problem in brucellosis control: a review. *Tidjsh v Diergeneesk* 118:679–683, 1993.
- Theodorou MK, Gill M, King-Spooner C, Beever DB. Enumeration of anaerobic chytridomycetes as thallus-forming units: quantification of fibrolytic fungal populations from the digestive tract ecosystem. *Appl Environ Microbiol* 56:1073–1078, 1990.
- Thurston B, Dawson KA, Strobel HJ. Cellobiose versus glucose utilization by the ruminal bacterium *Ruminococcus albus*. *Appl Environ Microbiol* 59:2631–2637, 1993.
- Trinci APJ, Davies DR, Gull K, Lawrence MI, Nielsen BB, Rickers A, Theodorou MK. Anaerobic fungi in herbivorous animals. *Mycol Res* 98:129–152, 1994.
- United States Public Health Service. Grade A Pasteurized Milk Ordinance. Publication No. 229, Washington, DC: Public Health Service, Food and Drug Administration, U.S. Department of Health and Human Services, 1993.
- Van der Poel WHM, Mourits MCM, Nielsen M, Frankena K, Van Oirschot JT, Schukken

- YH. Bovine respiratory syncytial virus reinfections and decreased milk yield in dairy cattle. *Vet Q* 17:77–81, 1993.
- van Egmond HP, ed. *Mycotoxins in Dairy Products*. London: Elsevier Applied Science, 1989.
- van Gylswyk NO. The effect of supplementing a low-protein hay on the cellulolytic bacteria in the rumen of sheep and on the digestibility of cellulose and hemicellulose. *J Agric Sci (Cambridge)* 74:169–180, 1970.
- van Gylswyk NO. *Succiniclasticum ruminis*, gen. nov., sp. nov., a ruminal bacterium converting succinate to propionate as the sole energy-yielding mechanism. *Int J Syst Bacteriol* 45:297–300, 1995.
- van Gylswyk NO. *Pseudobutyrvibrio ruminis*, gen. nov., sp. nov., a butyrate-producing bacterium from the the rumen that closely resembles *Butyrvibrio fibrisolvens* in phenotype. *Int J Syst Bacteriol* 46:559–563, 1996.
- Van Soest PJ. The uniformity and nutritive availability of cellulose. *Fed Proc* 32:1804–1810, 1973.
- Van Soest PJ. *Nutritional Ecology of the Ruminant*. 2nd ed. Ithaca, NY: Cornell University Press, 1994.
- Varel VH, Yen JT, Kreikemeier KK. Addition of cellulolytic clostridia to the bovine rumen and pig intestinal tract. *Appl Environ Microbiol* 61:1116–1119, 1995.
- Vogels GD, Hoppe WF, Stumm CK Association of methanogenic bacteria with rumen ciliates. *Appl Environ Microbiol* 40:608–612, 1980.
- Waldo DE, Smith LW, Cox EL. Models of cellulose disappearance from the rumen. *J Dairy Sci* 55:125–129, 1972.
- Wallace RJ, Atasoglu C, Newbold CJ. Role of peptides in rumen microbial metabolism: a review. *Asian Austr J Anim Sci* 12:139–147, 1999.
- Wang G, Zhao T, Doyle MP. Fate of enterohemorrhagic *Escherichia coli* O157:H7 in bovine feces. *Appl Environ Microbiol* 62:2567–2570, 1996.
- Weimer PJ. Effect of dilution rate and pH on the ruminal cellulolytic bacterium *Fibrobacter succinogenes* S85 in cellulose-fed continuous culture. *Arch Microbiol* 160:288–294, 1993.
- Weimer PJ. Why don't ruminal bacteria digest cellulose faster? *J Dairy Sci* 79:1496–1502, 1996.
- Weimer PJ, Shi Y, Odt CL. A segmented gas/liquid delivery system for continuous culture of microorganisms on insoluble substrates and its use for growth of *Ruminococcus flavefaciens* on cellulose. *Appl Microbiol Biotechnol* 36:178–183, 1991.
- Weimer PJ, Waghorn GC, Odt CL, Mertens DR. Effect of diet on populations of three species of ruminal cellulolytic bacteria in lactating dairy cows. *J Dairy Sci* 82:122–134, 1999.
- Wells GAH, Scott AC, Johnson CT, Gunning RF, Hancock RD, Jeffrey M. A novel progressive spongiform encephalopathy in cattle. *Vet Rec* 121:419–420, 1987.
- Williams PEV, Tait CAG, Innes GM, Newbold CJ. Effects of the inclusion of culture (*Saccharomyces cerevesiae* plus growth medium) in the diet of dairy cows on milk yield and forage degradation and fermentation patterns in the rumen of steers. *J Anim Sci* 69:3016–3026, 1991.
- Wilson JB, McEwen SA, Clarke RC, Leslie KE, Wilson RA, Waltner-Toews D, Gyles

- CL. Distribution and characteristics of verocytotoxigenic *Escherichia coli* isolated from Ontario dairy cattle. *Epidemiol Infect* 108:423–439, 1992.
- Wilson JR, Mertens DR. Cell wall accessibility and cell structure limitations to microbial digestion of forage. *Crop Sci* 35:251–259, 1995.
- Wiryawan KG, Brooker JD. Probiotic control of lactate accumulation in acutely grain-fed sheep. *Aust J Agric Res* 46:1555–1568, 1995.
- Woese CR, and Olsen GJ. Archaeobacterial phylogeny: perspectives on the urkingdoms. *Syst Appl Microbiol* 7:161–177, 1986.
- Wohlt JE, Finkelstein AD, Chung CH. Yeast culture to improve intake, nutrient digestibility, and performance by dairy cattle during early lactation. *J Dairy Sci* 74:1395–1400, 1991.
- Wolin MJ. Rumen fermentation: biochemical interactions between populations of the microbial community. In: Akin DE, Ljungdahl LG, Wilson JR, Harris PJ, eds. *Microbial and Plant Opportunities to Improve Lignocellulose Utilization in Ruminants*. New York: Elsevier, 1990, pp 237–251.
- Wood TM, Wilson CA, McCrae SI, Joblin KN. A highly active extracellular cellulase from the anaerobic rumen fungus *Neocallimastix frontalis*. *FEMS Microbiol Lett* 34:37–40, 1986.
- Woodford ST, Murphy MR. Effect of physical form on chewing activity, dry matter intake, and rumen function of dairy cows in early lactation. *J Dairy Sci* 71:674–686, 1988.
- Wu MC, Shanks RD, Lewin HA. Milk and fat production in dairy cattle influenced by advanced subclinical bovine leukemia virus infection. *Proc Natl Acad Sci USA* 86: 993–996, 1989.
- Zinn RA, Owens FN. Influence of level of feed intake on nitrogen metabolism in steers fed high concentrate rations. *Am Soc Anim Sci Abstr*, 1981, p 448.
- Ziolecki A. Isolation and characterization of large treponemes from the bovine rumen. *Appl Environ Microbiol* 37:131–135, 1979.

2

Raw Milk and Fluid Milk Products

Micaela Chadwick Hayes and Kathryn Boor

*Cornell University
Ithaca, New York*

I. INTRODUCTION

The microbiology of fluid milk impacts on production and consumption of dairy products in several different ways. Numerous types of bacteria can degrade milk components, creating negative sensory attributes, decreasing processed product shelf life and adversely affecting cultured dairy product yield. Since numerous pathogens are sometimes associated with milk and other dairy products, the microbiology of milk has implications for human health as well. This chapter will discuss various types of microorganisms that have been associated with raw milk and fluid milk products; microbiological techniques with which the microflora of milk samples can be assessed; various routes through which bacteria can contaminate raw milk; implications of microbial contamination for the quality of raw and processed milk; problems posed by heat-stable enzymes secreted by contaminating bacteria; and techniques for reducing and controlling bacterial numbers in raw and pasteurized milk.

II. MICROFLORA OF RAW MILK

Designed to provide complete nutrition for growing calves, bovine milk also provides a highly suitable growth medium for a variety of microorganisms. The abundance of carbohydrates, proteins, and fats combined with the neutral pH supports and encourages a microbial ecology that can be both diverse and highly variable. One can find numerous different organisms in raw milk, including psychrotrophs, which can grow at 7°C or less, irrespective of their optimum

Table 1 Human Microbial Pathogens Associated with Milk and Milk Products

Organism	Disease
Enterobacteriaceae	
<i>Escherichia coli</i> , including O157:H7	Gastroenteritis, hemolytic uremic syndrome
<i>Salmonella</i>	Gastroenteritis, typhoid fever
<i>Yersinia enterocolitica</i> (psychrotrophic)	Gastroenteritis
Other gram-negative bacteria	
<i>Aeromonas hydrophila</i> (psychrotrophic)	Gastroenteritis
<i>Brucella</i> spp.	Brucellosis (Bang's disease)
<i>Campylobacter jejuni</i>	Gastroenteritis
<i>Pseudomonas aeruginosa</i>	Gastroenteritis
Gram-positive spore formers	
<i>Bacillus cereus</i> (some strains are psychrotrophic)	Gastroenteritis
<i>Bacillus anthracis</i>	Anthrax
<i>Clostridium perfringens</i>	Gastroenteritis
<i>Clostridium botulinum</i> (type E is psychrotrophic)	Botulism
Gram-positive cocci	
<i>Staphylococcus aureus</i>	Emetic intoxication
<i>Streptococcus agalactiae</i>	Sore throat
<i>Streptococcus pyogenes</i>	Scarlet fever/sore throat
<i>Streptococcus zooepidemicus</i>	Pharyngitis, nephritic sequelae
Miscellaneous gram-positive bacteria	
<i>Corynebacterium</i> spp.	Diphtheria
<i>Listeria monocytogenes</i> (psychrotrophic)	Listeriosis
<i>Mycobacterium bovis</i>	Tuberculosis
<i>Mycobacterium tuberculosis</i>	Tuberculosis
<i>Mycobacterium paratuberculosis</i>	Johne's disease (ruminants)
Rickettsia	
<i>Coxiella burnetii</i>	Q fever
Viruses	
Enterovirus, including polioviruses, rotaviruses, Coxsackie viruses	Enteric infection
FMD virus	Foot-and-mouth disease
Hepatitis virus	Infectious hepatitis
Fungi	
Molds	Mycotoxicoeses
Protozoa	
<i>Entamoeba histolytica</i>	Amebiasis
<i>Giardia lamblia</i>	Giardiasis
<i>Toxoplasma gondii</i>	Toxoplasmosis

Source: Adapted from Boor, 1997, and Johnson et al., 1990.

growth temperature; coliforms and other gram-negative bacteria, which can be associated with unsanitary production and processing practices; thermophilic bacteria, which can survive pasteurization conditions; spore formers, which produce the heat- and desiccation-resistant structures known as spores; pathogens that cause mastitis, which can be shed into the milk by infected udders; and various yeasts and molds (Bramley and McKinnon, 1990; Gilmour and Rowe, 1990). As indicated in Table 1, a variety of microbes with human pathogenic potential, including *Listeria monocytogenes*, *Salmonella* spp., *Staphylococcus aureus* and *Mycobacterium tuberculosis*, can sometimes be found in raw milk (Bramley and McKinnon, 1990; Flowers et al., 1992; Johnson et al., 1990).

Psychrotrophic bacteria belonging to numerous genera have been isolated from milk, including *Pseudomonas*, *Enterobacter*, *Flavobacterium*, *Klebsiella*, *Aeromonas*, *Acinetobacter*, *Alcaligenes*, and *Achromobacter*. Certain genera of bacteria isolated from milk are both psychrotrophic and thermophilic, including gram-positive *Bacillus*, *Clostridium*, *Microbacterium*, *Micrococcus*, and *Corynebacterium* (Cousin, 1982; Suhren, 1989). Coliforms, which are defined as aerobic and facultatively anaerobic, asporogenous, gram-negative rods that ferment lactose with acid and gas production within 48 h at 32 or 35°C, include the genera *Escherichia*, *Enterobacter*, *Citrobacter*, and *Klebsiella* (Christen et al., 1992; Jay, 2000; Gilmour and Rowe, 1990). Aerobic gram-negative rods commonly found in milk include *Pseudomonas fluorescens*, *P. putida*, *P. fragi*, *P. putrefaciens*, and less frequently *P. aeruginosa* (Gilmour and Rowe, 1990).

Thermophilic bacteria belonging to numerous genera have also been isolated from milk, including *Microbacterium*, *Micrococcus*, and *Alcaligenes*. The spore-forming genera most relevant to milk and dairy products are *Bacillus* and *Clostridium*. *Bacillus* spp. have been implicated in spoilage of raw and pasteurized milk; ultrahigh temperature (UHT), concentrated and canned milk products; and ‘bitty’ cream and sweet curdling of pasteurized milk. *Clostridium* spp. have been implicated in the rancid spoilage and ‘late blowing’ of numerous cheeses (Gilmour and Rowe, 1990). Species of *Streptococcus*, *Lactobacillus*, and *Corynebacterium* also show some heat resistance, with less than 1% of a given population surviving a heat treatment of 63°C for 30 min (Bramley and McKinnon, 1990). Pathogens that cause mastitis include *Streptococcus uberis*, *S. dysgalactiae*, *S. agalactiae*, *Staphylococcus aureus*, coagulase-negative staphylococci, *P. aeruginosa*, *Mycoplasma bovis*, *Corynebacterium bovis*, and coliforms (Bramley and Dodd, 1984).

III. BACTERIAL CONTAMINATION

A. Raw Milk Contamination

Sources of bacterial contamination of raw milk can be divided into three general categories: environment, udder, and milking equipment. Environmental sources,

which include water, soil, vegetation, and bedding material, vary in the numbers and types of organisms that can be introduced into raw milk. In general, contamination with psychrotrophic microflora has been associated with bedding material, untreated water, soil, and vegetation; coliform contamination with soil; and spore formers with bedding material (Cousin, 1982; Suhren, 1989). Poor premilking udder hygiene that fails adequately to clean dirty udders can result in the introduction of vegetation, soil, and bedding material and their associated microorganisms into the milk. Thorough cleaning and drying of the udder immediately before milking lowers total bacterial numbers as well as coliform and *Staphylococcus* spp. counts and decreases milk sediment (Galton et al., 1984; Pankey, 1989). Bacterial contamination from within the udder is frequently a result of mastitis, an inflammation of the udder that can result in high levels of bacteria being shed into the milk. (see Chapter 1) Currently, *E. coli*, *Staph. aureus*, other staphylococci, *S. dysgalactiae*, and other streptococci are the most prevalent pathogens among dairy herds (Barkema et al., 1998; Sargeant et al., 1998; Waage et al., 1999). Since cows infected with *S. uberis* can shed up to 10^7 cfu/mL (Leigh, 1999) and cows infected with *E. coli* can shed up to 10^8 cfu/mL (Van Werven et al., 1997), one infected cow can influence total bacterial numbers in an entire bulk tank of milk. Since *Staph. aureus* is shed in relatively low numbers, typically less than 10,000 cfu/mL (Sears et al., 1990), *S. uberis* and *S. dysgalactiae* are often responsible for large increases in the total bacterial count of raw milk (Bramley et al., 1984). Although the microflora of a healthy udder can be shed into the raw milk, these organisms do not typically cause significant increases in the bulk tank total bacterial count.

Common contamination sources associated with milking equipment include milking machines, milk pipelines, bulk tanks, and transport tankers. Ineffective cleaning can leave milk residue throughout these various machines which can provide an excellent environment for microbial growth (see Chapter 14). Bacteria multiply within these residues and contaminate milk passing through the equipment.

B. Postpasteurization Contamination

Postpasteurization bacterial contamination provides a serious obstacle to maintaining and extending fluid milk product shelf life. Two major sources contribute to postpasteurization contamination: equipment milk residues and aerosols. Ineffective cleaning procedures of the interior of processing equipment create milk residues which can allow bacteria to multiply and contaminate subsequent milk flow (see Chapter 14). Filler nozzles, carton-forming mandrels, and pasteurizers have all been pinpointed as sources of postpasteurization contamination (Gruetzmacher and Bradley, 1999; Ralyea et al., 1998). Bacterial biofilms, which are difficult to remove with clean-in-place (CIP) procedures, can also form within

processing equipment and provide a constant source of contamination for both raw and pasteurized milk (Austin and Bergeron, 1995).

Unenclosed milk contact surfaces provide a route for microbial aerosols to contaminate pasteurized milk (Kang and Frank, 1989). During cleaning or operation, airborne yeast, molds, bacteria, and spores can land on a milk contact surface and thus enter the milk flow. An unenclosed filling unit (e.g., a federal-style filler) can allow exposure of the pasteurized milk to airborne bacteria, which can result in levels of postpasteurization contamination higher than those of milk packaged in a self-enclosed system (Douglas et al., 2000).

IV. MICROBIAL ANALYSIS OF RAW MILK

Characterization of the microbial population in raw milk (see Chapter 17) is of particular interest to dairy farmers and processors for several reasons. As indicated in Table 2, the U.S. Food and Drug Administration (FDA) guidelines detailed in the Pasteurized Milk Ordinance (PMO) require that total bacterial numbers of an individual producer's milk not exceed 100,000 cfu/mL before commingling with other producer milk; following pasteurization, total bacterial numbers are not to exceed 20,000 cfu/mL (U.S. Public Health Service, 1995). Therefore, the total bacterial count (TBC) of raw and pasteurized milk is determined to ensure that products meet FDA regulations. In addition, many processors and cooperatives have established price incentives or premium payments for raw milk with a low TBC. Thus, farmers and processors desire information about the TBC to determine premium allocations. The TBC is also of interest in

Table 2 Bacteriological Standards for Raw and Pasteurized Milk as Defined by the Pasteurized Milk Ordinance

Product	Test	Standard
Grade A raw milk and milk products	Total bacterial count	≤ 100,000 cfu/mL before commingling ≤ 300,000 cfu/mL after commingling
Grade A pasteurized milk and milk products	Total bacterial count	≤ 20,000 cfu/mL
Grade A aseptically processed milk and milk products	Coliform count Total bacterial count	≤ 10 cfu/mL No growth by standard plate count or other comparable method

Source: U.S. Public Health Service, 1995.

terms of milk quality and safety. Excessively high bacterial counts can overwhelm the bacterial thermal destruction capacity of a pasteurizer, resulting in pasteurized milk with high bacterial numbers that may be unsafe to consume and that may have reduced quality and shelf life. High bacterial counts in raw milk can also suggest the presence of bacterially produced enzymes that may adversely affect the quality of any fluid milk and processed product made from the raw milk.

For reasons noted above, analytical tests are routinely done to characterize the microbial population of raw milk samples. The TBC is typically determined by the standard plate count (SPC) or the Petrifilm (3M Company, St. Paul, MN) aerobic count (PAC). The SPC measures all bacteria able to form colonies on standard methods agar within 48 h under aerobic conditions at 32°C, whereas the PAC measures all bacteria able to form colonies on a nutrient medium embedded in a plastic film within 48 h at 32°C (Houghtby et al., 1992). Several alternative, but less commonly applied, techniques for estimating total bacterial numbers exist, including plate loop count, pectin gel plate count, spiral plate count, hydrophobic grid membrane filter most probable number count, and impedance/conductance method (Houghtby et al., 1992).

A notable new rapid method known as Bactoscan (Foss Food Technology Corp., Eden Prairie, MN) utilizes fluorescent staining to count individual bacterial cells. In this technique, somatic cells, fat globules, and casein particles are chemically degraded and then separated from bacterial cells by centrifugation in a saccharose-glycerol gradient. Bacterial cells are then stained with acridine orange and channeled beneath the objective of an epifluorescence microscope. As they pass under the objective, the bacteria are irradiated with filtered blue light, which causes red light pulses to be emitted from live bacteria. A photodetector fitted to the objective detects these pulses, which are then counted as individual bacterial cells (IBCs) (Rodriguez-Otero et al., 1993). Differences in acridine orange intercalation into cell DNA cause dead cells to emit green light, whereas live cells emit red light, thus ensuring that Bactoscan only counts live bacteria (Sharpe and Peterkin, 1988). Calibration of the Bactoscan apparatus using reference standards allows IBC/mL values to be translated into colony-forming units per milliliter values. This calibration step facilitates comparison of Bactoscan results with other TBC techniques. The Bactoscan method is unique in that it counts individual bacterial cells rather than the colony-forming units measured by most other tests, leading to values of IBCs per milliliter which may be significantly higher than corresponding colony-forming units per milliliter values, particularly in the presence of organisms such as many *Streptococcus* spp. and *Staphylococcus* spp. that form, for example, clusters, chains, duplets, or triplets. Although widely applied in Europe to analyze raw milk quality, the Bactoscan method is not currently approved for regulatory use in the United States.

Although information provided by the TBC is useful for determining pre-

mium allocations and for satisfying PMO regulations, it is of less utility for identifying specific sources of high bacterial counts or for assessing risks to milk quality posed by a particular bacterial population. Selective and/or differential tests that detect and quantify a specific type or group of bacteria can prove to be more useful. By doing tests that distinguish among microbial groups, one can identify the dominant organism(s) in a given bacterial population. The identity of dominant organism(s) can often suggest a possible contamination source or route and thus aid in focusing future contamination prevention efforts. The identity of dominant organism(s) can also help assess bacterial threat(s) to milk quality and safety. Many spore formers and thermophilic organisms, which can survive pasteurization, can also grow in the processed product and diminish product quality and shelf life. Psychrotrophs, which grow under refrigeration conditions, can multiply while raw milk awaits pasteurization, creating off-odors and off-flavors and chemically degrading milk components. Many heat-stable enzymes produced by psychrotrophs can also survive pasteurization and degrade the finished product, decreasing the shelf life of fluid milk products and adversely affecting yield of cultured products (Cousin, 1982). Individual selective tests can also prove to be useful for monitoring elimination of a specific contamination source. For example, a selective test that detects *S. agalactiae* could be employed to gauge the effectiveness of an *S. agalactiae* eradication program.

Numerous selective and differential tests can be used to determine the presence or absence of specific types of bacteria in raw milk. The laboratory pasteurized count (LPC), in which milk samples are heated to 62.8°C for 30 min before plating onto standard methods agar, estimates the number of thermophilic bacteria that could survive a batch pasteurization-type process (Frank et al., 1992; Murphy, 1997). The preliminary incubation count (PIC), in which milk samples are held at 12.8°C for 18 h before doing an SPC, gauges the number of bacteria capable of growth at cooler temperatures. A significant increase in the SPC after preliminary incubation is considered to be indicative of unsanitary production practices. The coliform count, in which samples are plated on the selective and differential medium Violet Red Bile Agar and incubated for 24 h at 32°C, estimates the number of coliform organisms present (Christen et al., 1992). The presence of these organisms can also indicate unsanitary production and processing practices. The selective and differential Edwards Medium can be used to isolate streptococci, which can be indicative of mastitis in the herd (Atlas, 1993). To meet other specific diagnostic objectives, procedures have been established to detect and quantify thermophilic organisms, proteolytic organisms, lipolytic organisms, lactic acid bacteria, enterococci, aerobic bacterial spores, and yeast and molds (Frank et al., 1992).

Characterization of the bacterial population present in raw milk must always consider the limitation inherent in any analytical technique: No one test can detect all bacteria. Even nonselective tests designed to determine total bacterial

numbers cannot detect fastidious organisms that require additional nutrients, slow-growing organisms that require more time to form visible colonies, or poor competitors that require selective media to ensure sufficient nutrient access. Furthermore, correlations are so low among results obtained from standard plate count, rapid psychrotrophic count, preliminary incubation count, aerobic spore count, and laboratory pasteurized count analyses from the same raw milk sample that one result cannot be used to estimate multiple different test results (Boor et al., 1998). Ultimately, no one test gives a complete picture of the microbial population; the picture must be pieced together using results from multiple different tests. Since doing all possible tests is neither economically nor logistically feasible, microbial analysis must involve deciding which tests will provide the most useful information about the microbial population of the particular product being examined. Additional information on the testing of milk and milk products can be found in Chapter 17.

V. EFFECTS OF MICROBIAL CONTAMINATION ON MILK QUALITY

A. Vegetative Growth

The presence and growth of bacteria in milk affects milk quality. Chemical components of milk can be degraded by bacterial metabolism and various enzymes secreted by bacteria. Products of these degradation reactions can have undesirable effects on milk structure, smell, and taste. Lactose present in milk is readily fermented by lactic acid bacteria, resulting in sour flavor notes and, if the pH of milk drops below 4.6, precipitation of casein proteins (Bylund, 1995; Jay, 2000). Fermentative metabolism of lactose by a variety of bacteria can also produce numerous volatile compounds, including acetic and butyric acids, carbon dioxide and hydrogen gas, and various alcohols that can adversely affect milk odor and flavor. Proteins are also subject to degradation by bacteria and their secreted enzymes. Digestion of proteins by extracellular proteases can create bitter-tasting peptides; cause curdling and clotting of the milk; result in production of ammonia and hydrogen sulfide; and ultimately cause gelation of the milk. Lecithinases hydrolyze lecithin molecules present in fat globule membranes, causing globule aggregation that results in flocking and lumping. Lipase, which breaks down triglycerides, creates short chain fatty acids that give milk a rancid smell and taste. Phospholipases hydrolyze phospholipids present in fat globule membranes making interior lipids more susceptible to lipase attack (Bylund 1995; Cousin, 1982). Growth of molds, yeasts, coliforms, *Pseudomonas* spp., *Actinomyces* spp., and *Lactococcus lactis* ssp. *lactis* biovar. *maltigenes* can give milk musty, fruity, cowlike, fishy, earthy, or malty odors, respectively.

B. Spore-Forming Bacteria

Most microorganisms present in raw milk are destroyed by exposure to time and temperature combinations currently in use for milk pasteurization. Minimizing the time between production and pasteurization and maintaining low storage temperatures will help control enzymatic degradation of raw milk through growth of heat-sensitive organisms. However, some spores and thermophilic organisms can survive pasteurization and affect the quality of fluid milk and other processed dairy products. Thermophilic organisms, such as some species of *Streptococcus* and *Lactobacillus*, and spore-forming organisms, such as *Bacillus*, can multiply within pasteurized milk products resulting in off-flavors and protein and lipid degradation. Psychrotrophic spore formers present a particularly difficult challenge, as they can survive pasteurization, germinate, and multiply in refrigerated conditions under which milk is stored (Boor et al., 1998; Douglas, 2000; Ralyea, 1998).

C. Heat-stable Enzymes

Numerous organisms commonly found in raw milk produce degradative enzymes that remain functional following heat treatment. Once these enzymes have been secreted, they have the potential to degrade both raw and processed milk components. Furthermore, refrigeration conditions under which raw milk is stored selects for growth of psychrotrophs, many of which produce heat-stable enzymes. These psychrotrophs can grow and secrete heat-stable enzymes while milk awaits processing. Following heat treatment, these enzymes can continue to degrade milk in the absence of viable bacterial cells. A variety of psychrotrophic organisms, including *P. fluorescens*, *P. putida*, *P. fragi*, *P. putrefaciens*, *Acinetobacter* spp., *Achromobacter* spp., *Flavobacterium* spp., *Aeromonas* spp., and *Serratia marcescens* produce heat-stable extracellular proteases (Mottar, 1989). Many psychrotrophs, including *P. fluorescens*, *P. fragi*, *P. putrefaciens*, *Achromobacter* spp., *Alcaligenes viscolactis*, *Acinetobacter* spp., and *Serratia marcescens*, produce heat-stable extracellular lipases (Mottar, 1989). Among these organisms, *Pseudomonas* spp. are commonly isolated from raw milk, frequently comprising 50% of the psychrotrophic flora (Suhren, 1989).

D. Mastitis

Mastitis directly impacts milk quality by raising the total bacterial number of raw milk through shedding from the infected udder. An indirect effect of mastitis can also have significant implications for milk quality. Whereas healthy udders typically shed low numbers of somatic cells, mastitic udders frequently shed 10^6

somatic cells/mL. This increased somatic cell count (SCC) can impact the quality of fluid milk and other dairy products. Ma et al. (2000) found that high SCC pasteurized milk (849,000 cells/mL) experienced rates of lipolysis and casein hydrolysis three and two times faster than those of low SCC pasteurized milk (45,000 cells/mL), respectively. Sensory defects, such as rancid, oxidized, and fruity aroma; salty, rancid, bitter and astringent taste; and bitter and lingering aftertaste, were detected in high SCC pasteurized milk after 21 days at 5°C. Standard plate counts, coliform counts, and psychrotrophic bacterial counts remained below 100,000 cfu/mL for both high and low SCC milk, suggesting that these effects were likely to be independent of contaminating bacteria. The SCC also affects cheese making with high SCC milk resulting in reduced curd firmness, decreased cheese yield, increased fat and casein loss in the whey, and sensory defects (Munro et al., 1984; Politis and Ng-Kwai-Hang, 1988a, 1988b).

VI. CONTROL OF MICROORGANISMS IN MILK

A. Refrigeration

Ideally, microbial contamination of raw milk and milk products should be addressed primarily through preventive measures on the farm and throughout processing. However, far too many contamination sources exist to prevent entry of all bacteria. Therefore, milk handling and processing strategies are designed to reduce and control bacterial numbers in processed products to protect milk quality and milk safety. The first of these measures involves efficient cooling of milk to 4°C immediately following milking. Reduced temperatures inhibit growth of mesophils and thermophils and reduce the activity of degradative enzymes. Modern dairy farms use refrigerated bulk storage tanks which maintain milk at 4°C or below. As bulk tank milk pick-up typically occurs daily or every other day, product from multiple milkings is frequently mixed and stored in the same tank. To prevent fresh, warm milk from the most recent milking from raising the temperature of milk already present in the bulk tank, many farms employ pretank cooling systems to reduce product temperature before addition to the tank.

B. Heat Treatment

Heat treatment plays a critical role in controlling bacterial numbers in processed milk products. The three basic approaches to heat treatment of raw milk, pasteurization, ultrapasteurization and UHT, differ primarily in their underlying purpose. Pasteurization aims to eliminate the non-spore-forming pathogen most resistant to thermal destruction, currently recognized as being *Coxiella burnetii*, and concurrently reduce nonpathogenic bacterial numbers in milk. Ultrapasteurization

adds the additional goal of increasing product shelf life through further reduction in total bacterial numbers. UHT processing aims to achieve microbial sterility to create a shelf-stable fluid milk product.

The PMO lists seven time and temperature combinations (Table 3) which are acceptable for milk pasteurization; these temperatures increase by 3°C if the milk product contains added sweeteners or greater than 10% fat. Two particular time and temperature combinations have become standard in the United States: low-temperature long-time (LTLT) and high-temperature short-time (HTST). In LTLT, or “vat,” pasteurization, which is commonly used for milk intended for manufactured products such as cheese and yogurt, milk is held at a minimum of 63°C for 30 min. In HTST pasteurization, which in the United States is currently most commonly used for fluid milk products, milk is held at a minimum of 72°C for 15 s. In ultrapasteurization, milk is held at a minimum of 138°C for at least 2 s, and in UHT processing, milk is held at 140–150°C for a few seconds (Bylund, 1995; U.S. Public Health Service, 1995). UHT processing involves the additional step of aseptic packaging in which heat-treated milk is cooled and packaged directly into sterilized containers under aseptic conditions. Typical shelf lives for heat-treated fluid milk are 14–21 days for HTST; 40–60 days for ultrapasteurized

Table 3 Minimum Pasteurization Time and Temperature Combinations as Defined by the Pasteurized Milk Ordinance

Temperature, °C (°F)	Time
63 (145) ^a	30 min
72 (161) ^a	15 s
89 (191)	1.0 s
90 (194)	0.5 s
94 (201)	0.1 s
96 (204)	0.05 s
100 (212)	0.01 s

^a If the fat content of the milk product is 10% or more, or if it contains added sweeteners, the specified temperature shall be increased by 3°C (5°F).

Source: U.S. Public Health Service, 1995.

(Boor and Nakimbugwe, 1998); and up to 6 months for UHT (Dunkley and Stevenson, 1987). Whereas HTST and ultrapasteurized products require refrigeration at 4°C or less during storage, UHT products can be stored at 25°C.

Currently, both direct and indirect methods are used to bring raw milk to pasteurization temperatures (Bylund, 1995). Direct heating strategies, which are most commonly used for UHT and ultrapasteurization, involve injecting raw milk with hot culinary steam until the desired temperature has been achieved. Controlled pressure changes during cooling ensure that the amount of water vapor that was injected into the milk is equal to the amount of water that evaporates from the milk during cooling, thus preventing dilution or concentration of the milk. Indirect heating strategies, which are most commonly used for LTLT and HTST pasteurization, utilize a heating fluid which is separated from milk by a physical barrier; typically a stainless steel pipe, plate, or vat. The two fluids flow side-by-side and either gain or lose heat via conduction through the metal barrier and convection within the fluids.

The effectiveness of heat treatment depends on three main factors: temperature to which milk is raised, length of time milk is held at the temperature, and resistance of microorganisms in milk to thermal destruction. Two graphical representations describe the interaction between these variables. The thermal death rate curve, also known as the survivor curve, plots time versus number of surviving organisms at a given temperature. The reciprocal slope of this curve, also known as the D value, indicates the length of time required to kill 90% of the microbial population at that specific temperature (Potter and Hotchkiss, 1995; Jay, 2000). Destruction of 90% of the microbial population is known as a one-log reduction. Thermal death time curves plot time versus temperature for a given number of organisms killed. The negative slope of this curve, known as the z value, indicates the degrees Fahrenheit needed for a 1 log cycle reduction in the thermal destruction curve (Potter and Hotchkiss, 1995; Jay 2000).

Resistance of microorganisms to thermal destruction depends on several factors, including product water activity, product pH, quantities of protein and colloidal particles present, number and physiological status of organisms in the total population, and the presence of heat-stable antibiotics or inhibitory compounds in the product (Jay, 2000). Water activity, which is a measure of unbound water present in a solution, is determined primarily by concentrations of sugars, fats, and salts in milk and heavily influences microbial resistance to thermal destruction. The higher the water activity of the product, the lower the heat resistance of organisms present in the product. This is likely to be the result of the increased rate of heat-induced protein coagulation caused by the presence of water. The effect of pH on thermal destruction characteristics depends on the particular bacterium, as organisms are most resistant at their optimum growth pH. In general, the optimum growth pH of most organisms, about 7, coincides with the pH of raw milk, suggesting that pH generally does not contribute to thermal

destruction of organisms in raw milk. The presence of protein and colloidal particles has a protective effect on bacteria, increasing their heat resistance by serving as a thermal buffer. Larger numbers of organisms similarly result in increased bacterial resistance to thermal destruction. The individual bacteria in a species are no more or less heat resistant; rather large numbers of bacteria present in milk act as a thermal buffer, raising the time necessary for all bacteria to reach the appropriate destructive temperature. Stationary phase cells tend to be more resistant to thermal destruction than logarithmic phase cells. The presence of heat-stable antibiotics or inhibitory compounds typically reduces resistance to thermal destruction.

C. Centrifugation

Two techniques known as clarification and Bactofugation (e.g., Westfalia Separator, Inc., Northvale, NJ) rely on the greater relative densities of bacterial cells and of other foreign particles to separate milk from contaminants. Centrifugation of milk causes denser bacteria, dirt particles, somatic cells, animal hairs, and bacterial spores to migrate outward, whereas lighter fat globules and casein micelles migrate inward. Appropriately designed outlet nozzles allow for separation of milk from contaminant sludge. Clarification is primarily designed to remove dirt particles, somatic cells, and animal hairs, whereas Bactofugation is specially designed to remove bacterial spores from milk (Spreer, 1998). Using high-force centrifugation, the spore load of raw milk can be reduced by greater than 99% (Olesen, 1989; Torres-Anjel and Hedrick, 1971).

D. Filtration

Microfiltration and ultrafiltration utilize the larger relative size of bacterial cells to separate out microbial contaminants. Filters with very small pores allow milk components to pass through while blocking bacteria, thus separating contaminants (Olesen, 1989). Typically rated in terms of pore diameter, microfiltration filters range from 0.2 to 5.0 μm . Using microfiltration, lactose, minerals, and small proteins pass through into the permeate, whereas fat, very large proteins, and bacteria are retained. Typically rated in terms of the largest molecular weight molecule that can pass through the pores, ultrafiltration filters range from 10^3 to 10^5 D. Using ultrafiltration, minerals and lactose pass through into the permeate, whereas proteins, fats, and bacteria are retained (Smith, 2000).

Although filtration can not remove all microorganisms, it can achieve a 99.99% reduction of the total bacterial count and a 99.95% reduction in the total spore count while allowing 5–6% of the solids in the bulk liquid to flow through into the permeate (Eckner and Zottola, 1991; Olesen, 1989). Effective bacterial retention appears to be determined primarily by the type and manufacturer of the

filter and the design and configuration of the filtration unit; the morphology of contaminating microbes does not appear to affect bacterial retention (Eckner and Zottola, 1991). Although the fat level does not affect bacterial retention, milk with higher fat percentages causes membrane fouling, making this technique most useful for treating skim milk.

E. Additional Microbial Control Methods

Several less commonly utilized techniques exist for controlling microbial growth in milk. Addition of carbon dioxide to milk at 10–30 mm/L inhibits growth of the common spoilage organism *P. fluorescens* (Muir, 1996). This technique has been reported to extend the shelf life of refrigerated milk by several days. The use of the natural antibiotic nisin to inhibit gram-positive bacterial growth in milk has also been explored (Muir, 1996). Addition of nisin to milk intended for clotted cream and processed cheese is currently approved in the United Kingdom. Addition of lactic acid starter cultures to raw milk has been shown to inhibit growth of psychrotrophs (Muir, 1996). Although the lactic acid bacteria do not multiply at refrigeration temperatures, their metabolism results in a pH decrease to below 6 and possible organoleptic changes.

VII. MICROBIOLOGY OF FLUID MILK PRODUCTS

A. Flavored Milks

The microbiology of flavored milk differs from that of unflavored milk in that conventionally pasteurized chocolate milk typically spoils faster than conventionally pasteurized unflavored milk. Douglas et al. (2000) found that after 14 days at 6°C, chocolate milk samples had higher standard plate counts and higher psychrotrophic plate counts than unflavored milk samples from the same raw milk batch ($P < .001$). Further experiments indicated that the chocolate powder, and not the additional sucrose, contributed to the increased bacterial growth. The chocolate powder did not introduce additional microbes into the milk. Rather microbes already present in the raw milk grew faster owing to the presence of the chocolate powder. Rosenow and Marth, (1987) in comparing growth of *Listeria monocytogenes* in skim, whole, and chocolate milk and in whipping cream also found that chocolate milk consistently produced the highest bacterial numbers by a factor of 10 or more.

B. Unflavored Milks

A wide variety of unflavored fluid milk products exist, including skim (< 0.5% fat), 1% fat, 2% fat, and whole milk; low-lactose (< 30% normal milk) and low-

sodium (< 100 mg/L) milk; and half-and-half (10.5–18.0% fat), light cream (18–30% fat), light whipping cream (30–36% fat), and heavy cream (> 36% fat) (US Public Health Service, 1995). Studies indicate that the microbiology of many of these products is quite similar. Brown et al. (1984) compared the shelf lives of skim (0.1% fat), semiskim (1.6% fat), and whole (3.8% fat) milk at 4 and 7°C and with and without *Pseudomonas* contamination and found no difference in the rate at which samples reached 10^7 cfu/mL. Similarly, Rosenow and Marth (1987) found no difference in the growth rate of *L. monocytogenes* in skim and whole milk and in whipping cream. The genera of spoilage bacteria found in pasteurized heavy cream and their lipolytic and proteolytic activities are comparable to the genera found in pasteurized milk, suggesting that fat standardization has little impact on the microbiology of the resulting cream and milk (Phillips et al. 1981).

Although the microbiology of various fluid milk products is similar, spoilage from nonmicrobial factors may vary from product to product. Recent data suggest that UHT-processed skim and whole milk behave differently during their respective shelf lives. López-Fandiño et al. (1993) found increased activity of both native and bacterially produced proteases in UHT-processed skim milk as compared to UHT-processed whole milk.

VIII. SUMMARY

Bacterial types and numbers present in raw milk are influenced by the health of the lactating cow, udder preparation practices, adequacy of equipment cleaning and sanitizing regimens, milk-cooling practices, and the length of time the milk is held before pasteurization. Residual bacterial populations in processed products are determined by initial numbers and types of bacteria in raw milk, time and temperature combination used to process milk, and care taken to prevent recontamination of the pasteurized product. Measures taken to protect raw and pasteurized products from contamination with bacteria contribute to final product quality and shelf life extension.

REFERENCES

- Atlas RM. Handbook of Microbiological Media. Parks LC, ed. Boca Raton, FL: CRC Press, 1993.
- Austin JW, Bergeron G. Development of bacterial biofilms in dairy processing lines. *J Dairy Res* 62:509–519, 1995.
- Barkema HW, Schukken YH, Lam TJGM, Beiboer ML, Wilmink H, Benedictus G, Brand A. Incidence of clinical mastitis in dairy herds grouped in three categories by bulk milk somatic cell counts. *J. Dairy Sci* 81:411–419, 1998.

- Boor KJ. Pathogenic microorganisms of concern to the dairy industry. *Dairy Food Environ Sanit* 17:714–717, 1997.
- Boor KJ, Nakimbugwe DN. Quality and stability of 2%-fat ultrapasteurized fluid milk products. *Dairy Food Environ Sanit* 18:78–82, 1998.
- Boor KJ, Brown DP, Murphy SC, Kozlowski SM, Bandler DK. Microbiological and chemical quality of raw milk in New York State. *J Dairy Sci* 81:1743–1748, 1998.
- Bramley AJ, Dodd FH. Reviews of the progress of dairy science: mastitis control—progress and prospects. *J Dairy Res* 51:481–512, 1984.
- Bramley AJ, McKinnon CH. The microbiology of raw milk. In: Robinson RK, ed. *Dairy Microbiology*. Vol 1. *The Microbiology of Milk*. 2nd ed. London: Elsevier, 1990, pp 163–208.
- Bramley AJ, McKinnon CH, Staker RT, Simpkin DL. The effect of udder infection on the bacterial flora of the bulk tank milk of ten dairy herds. *J Appl Bacteriol* 57:317–323, 1984.
- Brown JV, Ranjith HMP, Prentice GA. Comparative shelf-lives of skimmed, semi-skimmed and whole milks. *J Soc Dairy Technol* 37:132–135, 1987.
- Bylund G. *Dairy Processing Handbook*. Teknotext AB, ed. Lund, Sweden: Tetra Pak Processing Systems AB, 1995.
- Christen GL, Davidson PM, McAllister JS, Roth LA. Coliform and other indicator bacteria. In: Marshall RT, ed. *Standard Methods for the Examination of Dairy Products*. 16th ed. Washington, DC: American Public Health Association, 1992, pp 247–269.
- Cousin MA. Presence and activity of psychrotrophic microorganisms in milk and dairy products: a review. *J Food Prot* 45:172–207, 1982.
- Douglas SA, Gray MJ, Crandall AD, Boor KJ. Characterization of chocolate milk spoilage patterns. *J Food Prot* 63:516–521, 2000.
- Dunkley WL, Stevenson KE. Ultra-high temperature processing and aseptic packaging of dairy products. *J Dairy Sci* 70:2192–2202, 1987.
- Eckner KF, Zottola EA. Potential for the low-temperature pasteurization of dairy fluids using membrane processing. *J Food Prot* 54:793–797, 1991.
- Flowers RS, Andrews W, Donnelly CW, Koenig E. Pathogens in milk and milk products. In: Marshall RT, ed. *Standard Methods for the Examination of Dairy Products*. 16th ed. Washington, DC: American Public Health Association, 1992, pp 103–212.
- Frank JF, Christen GL, Bullerman LB. Tests for groups of microorganisms. In: Marshall RT, ed. *Standard Methods for the Examination of Dairy Products*. 16th ed. Washington, DC: American Public Health Association, 1992, pp 271–286.
- Galton DM, Petersson LG, Merrill WG, Bandler DK, Shuster DE. Effects of premilking udder preparation on bacterial population, sediment, and iodine residue in milk. *J Dairy Sci* 67:2580–2589, 1984.
- Gilmour A, Rowe MT. Micro-organisms associated with milk. In: Robinson RK, ed. *Dairy Microbiology*. Vol 1. *The Microbiology of Milk*. 2nd ed. London: Elsevier Applied Science, 1990, pp 37–75.
- Gruetzmacher TJ, Bradley RL, Jr. Identification and control of processing variables that affect the quality and safety of fluid milk. *J Food Prot* 62:625–631, 1999.
- Houghtby GA, Maturin LJ, Koenig EK. Microbiological count methods. In: Marshall RT, ed. *Standard Methods for the Examination of Dairy Products*. 16th ed. Washington, DC: American Public Health Association, 1992, pp 213–246.

- Jay JM. Modern Food Microbiology. 6th ed. Gaithersburg, MD: Aspen, 2000.
- Johnson EA, Nelson JH, Johnson M. Microbiological safety of cheese made from heat-treated milk, Part II. Microbiology. J Food Prot 53:519–540, 1990.
- Kang Y, Frank JF. Biological aerosols: a review of airborne contamination and its measurement in dairy processing plants. J Food Prot 52:512–524, 1989.
- Leigh JA. *Streptococcus uberis*: a permanent barrier to the control of bovine mastitis? Vet J 157:225–238, 1999.
- López-Fandiño R, Olano A, Corzo N, Ramos M. Proteolysis during storage of UHT milk: differences between whole and skim milk. J Dairy Res 60:339–347, 1993.
- Ma Y, Ryan C, Barbano DM, Galton DM, Rudan MA, Boor KJ. Effects of somatic cell count on quality and shelf-life of pasteurized fluid milk. J Dairy Sci 83:264–274, 2000.
- Mottar JF. Effect on the quality of dairy products. In: McKellar RC, ed. Enzymes of Psychrotrophs in Raw Food. Boca Raton, FL: CRC Press, pp 227–243, 1989.
- Muir DD. The shelf-life of dairy products: 1. Factors influencing raw milk and fresh products. J Soc Dairy Technol 49:24–32, 1996.
- Munro GL, Grieve PA, Kitchen BJ. Effects of mastitis on milk yield, milk composition, processing properties and yield and quality of milk products. Aust J Dairy Technol 39:7–16, 1984.
- Murphy S. Raw milk bacteria tests: standard plate count, laboratory pasteurization count, preliminary incubation count and coliform count—What do they mean for your farm? Syracuse, NY: National Mastitis Council Regional Meeting Proceedings, 1997.
- Olesen N, Jensen F. Microfiltration. The influence of operation parameters on the process. Milchwissenschaft. 44:476–479, 1989.
- Pankey JW. Premilking udder hygiene. J Dairy Sci 72:1308–1312, 1989.
- Phillips JD, Griffiths MW, Muir DD. Growth and associated enzymatic activity of spoilage bacteria in pasteurized double cream. J Soc Dairy Technol 34:113–118, 1981.
- Politis I, Ng-Kwai-Hang KF. Effects of somatic cell counts and milk composition on cheese composition and coagulating properties of milk. J Dairy Sci 71:1711–1719, 1988a.
- Politis I, Ng-Kwai-Hang KF. Association between somatic cell counts of milk and cheese yielding capacity. J Dairy Sci 71:1720–1717, 1988b.
- Potter NN, Hotchkiss JH. Food Science. 5th ed. New York: Chapman & Hall, 1995.
- Ralyea RD, Wiedmann M, Boor KJ. Bacterial tracking in a dairy production system using phenotypic and ribotyping methods. J Food Prot 61:1336–1340, 1998.
- Rodriguez-Otero JL, Hermida M, Cepeda A, Franco C. Total bacterial count in raw milk using the BactoScan 8000. J AOAC Int 76:838–841, 1993.
- Rosenow EM, Marth EH. Growth of *Listeria monocytogenes* in skim, whole, and chocolate milk, and in whipping cream during incubation at 4, 8, 13, 21 and 35°C. J Food Prot 50:452–459, 1987.
- Sargeant JM, Scott HM, Leslie KE, Ireland MJ, Bahiri A. Clinical mastitis in dairy cattle in Ontario: frequency of occurrence and bacteriological isolates. Can Vet J 39:33–38, 1998.
- Sears PM, Smith BS, English PB, Herer PS, Gonzalez RN. Shedding pattern of *Staphylococcus aureus* from bovine intramammary infections. J Dairy Sci 73:2785–2789, 1990.

- Sharpe AN, Peterkin PI. Membrane Filter Food Microbiology. New York: J Wiley, 1988.
- Smith K. Mechanics of membrane processes, Part 2. A focus on the dairy industry. Dairy Pipeline, Wisconsin Center for Dairy Research, 12:6–7, 2000.
- Spreer E. Milk and Dairy Product Technology. New York: Marcel Dekker, 1998.
- Suhren G. Producer microorganisms. In: McKellar RC, ed. Enzymes of Psychrotrophs in Raw Food. Boca Raton, FL: CRC Press, 1989, pp 3–34.
- Torres-Anjel MJ, Hedrick TI. Spore removal by centrifugation and its effects of ultra-high temperature commercial sterilization of milk. J Dairy Sci 54:326–330, 1971.
- United States Public Health Service. Grade A Pasteurized Milk Ordinance. Publication No. 229, Food and Drug Administration, Washington DC: 1995.
- Van Werven T, Noordhuizen-Stassen EN, Daemen AJJM, Schukken YH, Brand A, Burvenich C. Preinfection in vitro chemotaxis, phagocytosis, oxidative burst, and expression of CD11/CD18 receptors and their predictive capacity on the outcome of mastitis induced in dairy cows with *Escherichia coli*. J Dairy Sci 80:67–74, 1997.
- Waage S, Mork T, Roros A, Aasland D, Hunshamar A, Odegaard SA. Bacteria associated with clinical mastitis in dairy heifers. J Dairy Sci 82:712–719, 1999.

3

Concentrated and Dry Milks and Wheys

Warren S. Clark, Jr.

*American Dairy Products Institute
Chicago, Illinois*

I. INTRODUCTION

Fluid milk and whey are perishable dairy products that require proper cooling and handling to maintain their freshness and quality. However, milk and whey solids may be preserved for future use by various methods, the most common of which is concentration by removing water, using either heat or membrane methodology, followed by drying. Dairy products commonly manufactured through the use of one or more of these processes are evaporated milks, condensed and sweetened condensed milks, dry milks, condensed whey products, and dry whey products. Emphasis in this chapter is given to the major products and similarities are made to other closely related products.

All evaporated milks and most condensed, sweetened condensed, and dry milk products are manufactured using grade A raw milk (U.S. Public Health Service, 1997). In some areas of the United States, condensed and dry whey products also are made entirely from raw milk meeting grade A requirements. Overall, however, a lesser quantity of condensed and dry whey products is manufactured using grade A milk. In those instances, milk that meets U.S. Department of Agriculture (USDA) requirements (U.S. Department of Agriculture, 1972) is used. Current estimates (D. R. Spomer, personal communication, 2000) are that 3% of the U.S. milk supply is non-grade A and that approximately 5% of domestic manufactured dairy products (condensed and dry milks, condensed and dry wheys, cheese, and butter) are made from milk meeting USDA requirements. All milk and whey used to manufacture concentrated and dry milk and whey products are pasteurized (see Chapter 2).

II. CONDENSED MILK

Bulk condensed milk may be manufactured using either whole or skim milk. Typically, milk is pasteurized and then concentrated by heat in an evaporator until the product contains 40–45% total solids. Following concentration, the product may be dried or distributed for use as a concentrated milk. A detailed processing scheme for condensed milk is shown in Fig. 1. Most condensed whole milk is used as an ingredient in chocolate/confectionery, bakery, or dairy (frozen dessert) industries; condensed skim milk not subsequently dried is used primarily within the dairy industry (American Dairy Products Institute, 1999a). These products are not commercially sterile and, when intended for shipment as an ingredient, they immediately are cooled and continuously held at temperatures below 7°C (45°F). Microorganisms surviving the heat treatments usually are thermotolerant or thermophilic types. Under proper handling and storage conditions, these organisms grow slowly, if at all, and are not expected to create keeping quality

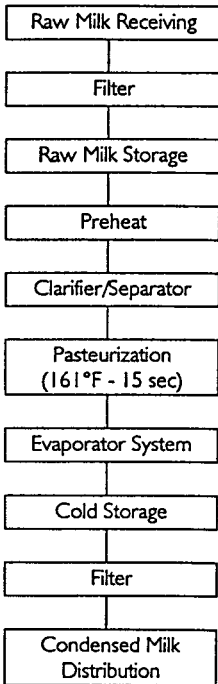

Figure 1 Processing scheme for condensed milk.

problems. If spoilage occurs, it usually is attributed to postheating contamination. Psychrotrophic bacteria, yeasts, or molds may cause spoilage if product is held for unusually long periods or under improper storage conditions.

III. SWEETENED CONDENSED BULK AND CANNED MILK

The primary difference between condensed and sweetened condensed milks is addition of sugar. Sweetened condensed milk is preserved by addition of sugar, which reduces water activity to a point inhibitory to most microorganisms. The increased milk solids content also decreases the water activity. The sugar-in-water concentration of sweetened condensed milk is called the sugar ratio, which is calculated as follows:

$$\frac{\% \text{ Sugar in condensed milk}}{100 - \text{Total milk solids in condensed milk}} \times 100 = \text{Sugar ratio}$$

Like condensed milk, sweetened condensed milk may be as whole milk or skim milk and be used either in bulk or consumer (canned) form. Most sweetened condensed milk is whole and is used in bulk in bakery and confectionery industries. With modern processing, storage, and handling practices, spoilage seldom is encountered. If the bulk product is improperly handled or held for extended periods before use, surface growth of yeasts or molds may occur. These microorganisms are the most common cause of spoilage of sweetened condensed milks. Their presence is indicative of unsanitary postpasteurization conditions. The consumer (canned) product has been thermally processed and is commercially sterile (see Sec. IV).

IV. EVAPORATED MILKS

A. History

Evaporated milk, like other processed canned foods, originated with the experiments of the French scientist Nicholas Appert (Clark, 2000a). Appert, whose work on food preservation began in 1795, was the first person to evaporate milk by boiling it in an open container and then preserving it by heating the product in a sealed container. Fifty years later, another French scientist, Louis Pasteur, laid the scientific foundation for heat preservation through demonstrations that food spoilage could be caused by bacteria and other microorganisms.

Patents dealing with preservation of milk after evaporation in a vacuum were granted to Gail Borden by the United States and England in 1856. These

patents applied to concentrating milk without addition of sugar. In 1884, U.S. patent number 308,421 was issued for “an apparatus for preserving milk” and, in 1885, the first commercial evaporated milk plant in the world was opened in a converted wool factory in Highland, IL, where “evaporated cream” was manufactured and sold (Clark, 2000a).

B. Products and Processing

Evaporated milk is a canned whole milk concentrate to which a specified quantity of vitamin D has been added and to which vitamin A may be added. It conforms to the U.S. Food and Drug Administration (FDA) Standard of Identity 21 CFR 131.130 (U.S. Department of Health and Human Services, 1999a), having a minimum of 6.5% milkfat, 16.5% milk solids-not-fat, 23% total milk solids, and 25 IU vitamin D per fluid ounce. Related evaporated milk products are evaporated skim milk, evaporated low-fat milk, evaporated filled milk, and evaporated goat’s milk. Evaporated skim milk contains not less than 20% of total milk solids, not more than 0.5% milkfat, with added vitamins of 25 IU vitamin D and 125 IU vitamin A per fluid ounce. Typical compositions for other evaporated milk products are as follows:

Evaporated low-fat milk: 2% milk fat, 18% nonfat milk solids, vitamins A and D added

Evaporated filled milk: 6% vegetable fat, 17.5% nonfat milk solids, vitamins A and D added

Evaporated goat’s milk: not less than 7% milkfat and 15% nonfat milk solids, vitamin D added

A typical processing scheme for evaporated milk (Fig. 2) begins with high-quality, fresh whole milk to which vitamins, emulsifiers, and stabilizers are added. The product is then pasteurized, concentrated under reduced pressure in an evaporator, homogenized, cooled, and standardized to the composition desired in the final product. After cans are filled and sealed, they are sterilized in a three-phase continuous system consisting of preheater, retort, and cooler and then labeled and packed for shipment. In the United States, evaporated milk is packed in 5-, 12-, and 97-fl oz lead-free cans. In 1999, production of evaporated milk and related products (evaporated skim milk, evaporated low-fat milk, and evaporated filled milk) was slightly more than 477 million pounds (American Dairy Products Institute, 2000).

Evaporated milk processing is covered by FDA regulations dealing with thermally processed low-acid foods packaged in hermetically sealed containers (U.S. Department of Health and Human Services, 1999b). Therefore, manufacturers of evaporated milk and related products must comply with stringent pro-

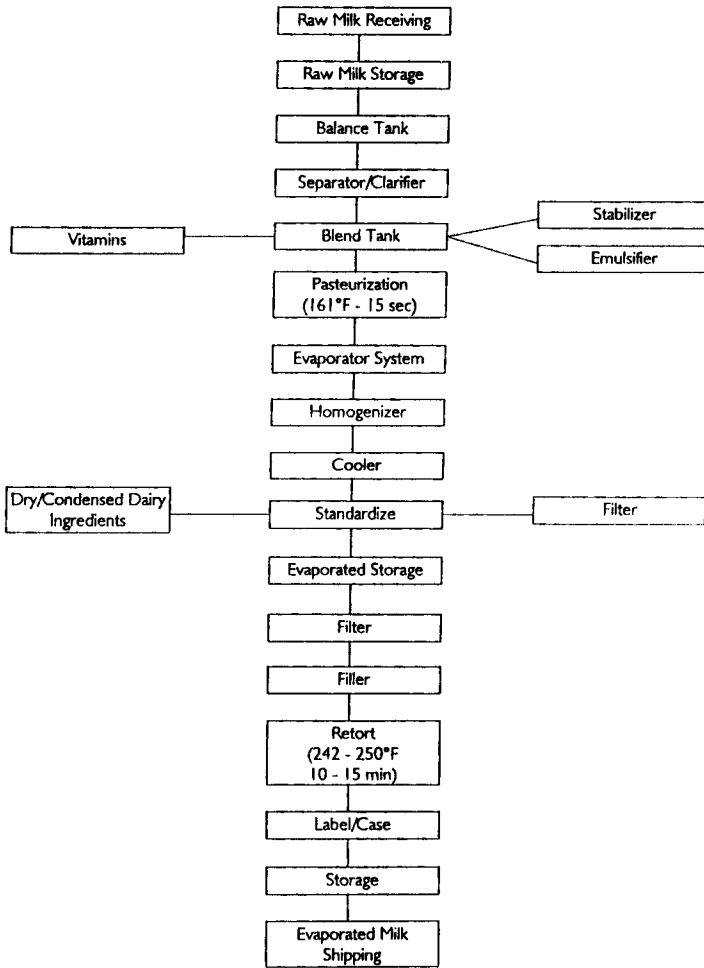

Figure 2 Processing scheme for evaporated milk.

cessing regulations, including establishment and filing of scheduled processes with the FDA and maintenance of strict processing records.

C. Microbiology

Because of the heat processes and packaging used to manufacture evaporated milks, the product is commercially sterile. This means that the product is free of all microorganisms of public health significance and does not show microbial

defects during its intended shelf life under normal conditions of handling, storage, and distribution. Whereas vegetative cells do not survive evaporated milk processing, and absolute sterility is obtained in most cans, small numbers of non-pathogenic spores occasionally may survive the heat treatment and, depending on the microorganism and its previous growth and heat exposure, subsequently may germinate (Curran and Evans, 1945). Kalogridou-Vassiliadou (1992) studied 40 strains of bacilli implicated in causing flat sour spoilage in evaporated milk. The microorganisms were identified as *Bacillus stearothermophilus* (five strains), *B. licheniformis* (10 strains), *B. coagulans* (15 strains), *B. macerans* (five strains), and *B. subtilis* (five strains). Species of the genus *Bacillus* (i.e., *cereus*, *coagulans*, *megatherium*, *stearothermophilus*, and *subtilis*) earlier were implicated in evaporated milk spoilage (Foster et al., 1957; Hammer and Babel, 1957). Langeveld et al. (1996), in studies of *B. cereus* naturally present in raw milk, reported no evidence that this organism would cause intoxication in healthy adult humans at levels less than 10^5 /mL. Beard et al. (1999) and Wandling et al. (1999) studied the effects various concentrations of the bacteriocin nisin had on thermal resistance of *Bacillus* spores in dairy products. They reported that although addition of nisin lowered decimal reduction times (D values) for spores of *B. cereus*, *B. stearothermophilus*, and *B. licheniformis*, it apparently required specific nutrients to sensitize spores to heat. Medium composition, exposure time, and pH also had an effect on the heat sensitivity. Classic studies (Curran and Evans, 1945; Theophilus and Hammer, 1938) on the microbiology of evaporated milk have contributed significantly to the knowledge of the microbiology of this product.

Under current continuous processing conditions wherein heat treatments of 117–121°C (242–250°F) for 10–15 min are common, and batch retorting is uncommon, spoilage of evaporated milk is unlikely to be encountered. Specific methods for microbiological examination of evaporated milk are contained in *Standard Methods for the Examination of Dairy Products* (Marshall, 1992).

V. DRY MILKS

A. History

Development of the dry milk industry stems from the days of Marco Polo in the 13th century. It is reported that Marco Polo encountered sun-dried milk on his journeys through Mongolia and that, from this beginning, dry milk products evolved (Clark, 2000b). Through early pioneering scientists, such as Appert and Borden, the basic methods were developed for the emergence of processes for drying milk products. Ekenberg and Merrill have been acknowledged as developers of the first commercial roller- and spray-process drying systems, respectively, in the United States (Beardslee, 1948). Since initial development of commercial

drying systems, significant technological advances have been made, resulting in the manufacture of a variety of dry milk products.

B. Products and Processing

The primary dry milk products manufactured domestically are nonfat dry milk, dry whole milk, and dry buttermilk. Nonfat dry milk is the product resulting from removal of fat and water from milk. It contains lactose, milk proteins, and milk minerals in the same relative proportions as the fresh milk from which it is made. Nonfat dry milk contains not more than 5% by weight of moisture. The fat content is not more than 1.5% by weight unless otherwise indicated. Dry whole milk is the product resulting from removal of water from milk and contains not less than 26% milkfat and not more than 4% moisture. Dry whole milks with milkfat contents of 26.0 and 28.5% are most commonly produced. Dry buttermilk is the product resulting from removal of water from liquid buttermilk derived from manufacture of butter. It contains not less than 4.5% milkfat and not more than 5% moisture.

Steps in a typical dry milk processing operation include (a) receipt of fresh, high-quality milk delivered in refrigerated, stainless-steel bulk tankers; (b) clarification, and, if nonfat dry milk is to be manufactured, (c) separation. The milkfat removed usually is churned into butter. If dry whole milk is to be manufactured, the separation step is omitted but may be replaced by a standardization procedure. Pasteurization by a continuous high-temperature short-time (HTST) process, whereby every particle of milk is subjected to a heat treatment of at least 72°C (161°F) for 15 s is accomplished next. Holding the pasteurized milk at an elevated temperature for an extended period (85°C [185°F] for 20–30 min) is used in the manufacture of high-heat nonfat dry milk, which commonly is used as an ingredient in bakery or meat products. Following concentration of milk by removing water in an evaporator until a milk solids content of at least 40% is reached, the product enters the dryer for final moisture removal.

Commercial U.S. drying processes are of two types: spray and roller (drum). Currently, the latter is used to a limited extent and primarily for product intended for other than human consumption. Two basic configurations of spray dryers are in use: horizontal (box) and vertical (tower). In both, the pasteurized and concentrated milk is directed under pressure to a spray nozzle (horizontal dryer) or to either a spray nozzle or an atomizer (vertical dryer) where the dispersed liquid then comes into contact with a current of filtered, heated air. The droplets of milk are dried almost immediately and fall to the bottom of the fully enclosed stainless steel drying chamber. The dry milk product is continuously removed from the drying chamber, transported through a cooling and collecting system, and finally conveyed into a hopper for packaging, usually

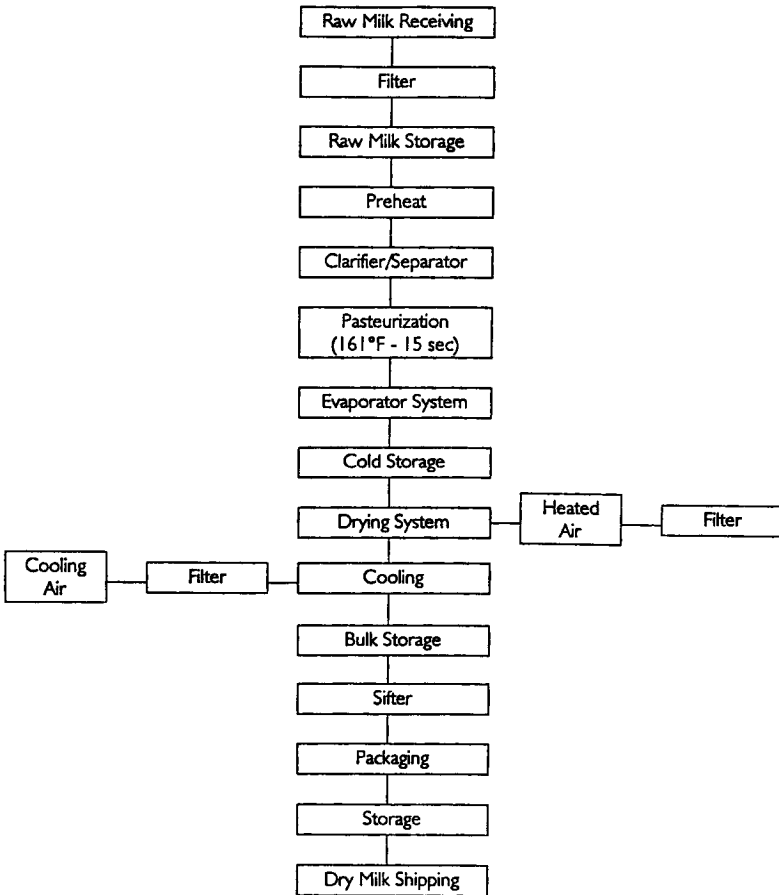

Figure 3 Processing scheme for dry milk.

in 50-lb bags or in tote bins. Figure 3 reflects a typical processing scheme for dry milk.

In processing nonfat dry milk, various heat treatments may be applied to give the finished dry milk product desirable functional characteristics. Three heat-treatment classifications, based on the use of the whey protein nitrogen test, are of practical importance in indicating the suitability of spray-process nonfat dry milk for specific purposes (American Dairy Products Institute, 1990). Instant-type dry milks are processed by special methods that result in products with improved solubility. Instant nonfat dry milk is defined by its solubility index value (American Dairy Products Institute, 1990).

The American Dairy Products Institute (1999a) publishes annual census figures that reflect markets of end use for dry milk products, which may be referenced for further information about quantities of dry milks processed and their use. In 1998, U.S. production of nonfat dry milk was 1.1 billion pounds, dry whole milk production was 139 million pounds, and dry buttermilk production was 49 million pounds (American Dairy Products Institute, 1999a).

C. Standards

Industry microbiological standards for dry milk products are established by the American Dairy Products Institute. In addition, government standards for these products also have been generated by the USDA and the FDA (U.S. Public Health Service, 1995). Table 1 shows these standards by source, product, and, as applicable, grade.

D. Microbiology

Relatively few species of bacteria have been reported as naturally occurring in dry milks. Hammer and Babel (1957) and Foster et al. (1957), in earlier texts covering the microbiology of dry milk products, summarized literature reports indicating microorganisms of the genera *Streptococcus*, *Micrococcus*, *Bacillus*, *Clostridium*, and *Sarcina* as comprising the primary microflora of dry milks. Rodriquez and Barrett (1986), based on a study of the microbial population and growth in reconstituted dry milk, confirmed the occurrence of viable cells of the genera *Bacillus* and *Micrococcus* in nonfat and dry whole milks.

Since initiation of the requirement that all milk be pasteurized before drying, current heat treatments used to process dry milks destroy all microorganisms of public health significance. Relatively low numbers of microorganisms survive processing, and those heat-resistant organisms (both spore-forming and non-spore-forming types) rarely, if ever, are responsible for finished product deterioration. Because the drying process is accomplished in a completely closed system, postprocessing contamination also is rare. When such occurs, it usually is from an airborne source. Because of low moisture levels in dry milks, those viable organisms that may be present are unable to grow and decrease in number during storage. Specific methods for microbiological examination of dry milks are contained in *Standard Methods for the Examination of Dairy Products* (Marshall, 1992).

Spray-dried milks have been implicated in outbreaks of staphylococcal food poisoning (Anderson and Stone, 1955; Armijo et al., 1957). In both instances, illness were caused by a preformed enterotoxin that was not inactivated by the drying process. Miller et al. (1972), in a study of the effect of spray drying on survival of *Salmonella* and *Escherichia coli*, reported that heat treatments

Table 1 Microbiological Standards for Condensed and Dry Milk Products^a

Product	American Dairy Products Institute standards ^b	United States Department of Agriculture standards ^b	Food and Drug Administration (grade A) standards
Condensed milk	None	None	Bacterial estimate: 30,000/g Coliform: 10/g
Nonfat dry milk			
Extra grade	SPC: 10,000/g Coliform: 10/g	SPC: 10,000/g Coliform: 10/g	Bacterial estimate: 30,000/g Coliform: 10/g
Standard grade	SPC: 75,000/g Coliform: 10/g	SPC: 75,000/g Coliform: 10/g	
Dry whole milk			
Extra grade	SPC: 10,000/g Coliform: 10/g	SPC: 10,000/g Coliform: 10/g	None
Standard grade	SPC: 50,000/g Coliform: 10/g	SPC: 50,000/g Coliform: 10/g	
Dry Buttermilk			
Extra grade	SPC: 20,000/g Coliform: 10/g	SPC: 20,000/g Coliform: 10/g	Bacterial estimate: 30,000/g Coliform: 10/g
Standard grade	SPC: 75,000/g Coliform: 10/g	SPC: 75,000/g Coliform: 10/g	

DMC, direct microscopic clump count; SPC, standard plate count.

^a All counts expressed as “not more than.”

^b DMC may not exceed 100 million/g for ADPI- and USDA-graded nonfat dry milk and dry whole milk.

typically associated with spray drying could not be counted on to supplant adequate pasteurization and postdrying sanitary procedures. Bradshaw et al. (1987), in studies of the thermal resistance of disease-associated *Salmonella* Typhimurium in milk, reported the organism did not survive pasteurization.

Doyle et al. (1985) studied survival of *Listeria monocytogenes* during manufacture and storage of nonfat dry milk. Concentrated (30% solids) and unconcentrated skim milks were inoculated with 10^5 – 10^6 *L. monocytogenes*/mL. They reported reductions of 1.0–1.5 \log_{10} *L. monocytogenes*/g occurred during the spray drying process and that the organism progressively died during storage. The inoculated milks were not pasteurized before drying. Bradshaw et al. (1985) and Donnelly et al. (1987) reported that *L. monocytogenes* did not survive in milk during pasteurization. Earlier studies (Nichols, 1939; Higginbottom, 1944) also reported on destruction of microorganisms during drying and the fate of surviving organisms during storage.

VI. DRY WHEY PRODUCTS

A. History

Although spray and roller processes have been used to dry whey for many years, development of a whey processing industry in the United States did not fully materialize until organization of the Whey Products Institute in 1971 (Clark, 1991). At that time, development of product identity and quality standards was undertaken as a guide to production of uniformly high-quality whey products. In 1981, the FDA accepted industry-recommended common and usual names for a variety of whey products and affirmed the generally recognized as safe (GRAS) status of these products and their method of manufacture (U.S. Department of Health and Human Services, 1981). Technological changes associated with whey processing are dynamic. In no area of the modern dairy industry have changes of a technical nature been as innovative and rapid as in the whey products segment. Important applications to whey processing include the use of selective membrane techniques that allow various whey constituents to be separated into protein-, carbohydrate-, or mineral-rich streams, which then may be further processed and made available in concentrated functional forms. Significant further developments, reflecting continuing changes, are anticipated in this area.

B. Products and Processing

The primary whey products currently manufactured in the United States are concentrated and dry whey and the modified whey products, including reduced-lactose whey, reduced-minerals whey, and whey protein concentrate. Other modified whey products manufactured in smaller quantities include lactalbumin (minimum

protein content 80%) and whey protein isolate (minimum protein content 90%). Lactose, the carbohydrate of milk, also is being produced in large quantities as a coproduct with the manufacture of modified wheys. Table 2 defines the commonly known whey products currently being manufactured.

A typical processing scheme for manufacture of dry whey is shown in Figure 4. Some whey-drying operations receive only condensed whey for processing; others receive condensed and fresh fluid whey. The solids concentration of transported condensed whey and the time-temperature conditions of its shipment determine how the product is processed before entering the drying system. Currently, the USDA requires all condensed whey containing less than 40% solids to be pasteurized or repasteurized in the processing plant where it is to be dried. The process of drying is similar to that used to manufacture dry milks, and some processing plants may dry both products interchangeably.

Processing operations to manufacture modified whey products include reverse osmosis, ultrafiltration, and electrodialysis procedures, some of which may be proprietary in nature. For more information on these processes, various published texts (Sienkiewicz and Riedel, 1990; Gillies, 1974) may be consulted.

The American Dairy Products Institute (1999b) publishes data annually that reflect production and utilization trends for whey products. In 1998, nearly 2.2 billion pounds of whey solids were processed in the United States as follows: 1.2 billion pounds of dry whey; 109 million pounds (solids) as condensed whey; 105 million pounds of reduced-lactose and reduced-minerals whey; 285 million pounds of whey protein concentrate; and 454 million pounds of lactose.

Table 2 Composition of Whey Products

Name of product	Major parameters (%) ^a				
	Protein	Fat	Ash	Lactose	Moisture
Whey ^b	10–15	0.2–2.0	7–14	61–75	1–8
Concentrated whey ^b	10–15	0.2–2.0	7–14	61–75	1–8
Dry or dried whey ^b	10–15	0.2–2.0	7–14	61–75	1–8
Reduced-lactose whey ^b	16–24	0.2–4.0	11–27	60 max	1–6
Reduced-minerals whey ^b	10–24	0.2–4.0	7 max	85 max	1–6
Whey protein concentrate ^b	25 min	0.2–10.0	2–15	60 max	1–6
Whey protein isolate ^c	90 min	N/A	6 max	6 max	6 max
Dairy product solids ^c	10 max	N/A	27 max	59 min	6 max
Lactose ^b	N/A	N/A	0.3	98 min	4–6

^a On dry product basis.

^b FDA affirmation of direct food substances as generally recognized as safe.

^c FDA concurrence with ADPI notification of generally recognized as safe status.

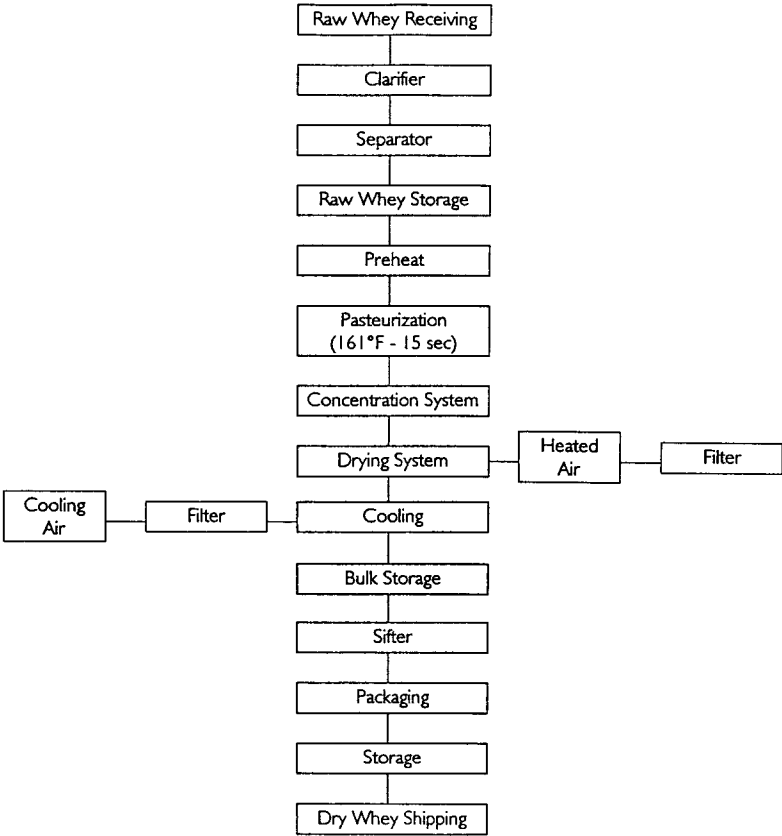

Figure 4 Processing scheme for manufacture of dry whey.

C. Standards

As for dry milk products, industry microbiological standards for whey products have been established by the American Dairy Products Institute, the USDA, and the FDA. Table 3 shows current microbiological standards for whey products.

D. Microbiology

As drying processes for whey are essentially the same as those for milk, the discussion of dry milk microbiology also applies to dry whey. Microbiological methods to assay the quality of whey products are contained in *Standard Methods for the Examination of Dairy Products* (Marshall, 1992). Cultural or direct micro-

Table 3 Microbiological Standards for Whey Products^a

Product	American Dairy Products Institute standards	United States Department of Agriculture standards	Food and Drug Administration (grade A) standards ^b
Condensed whey	None	None	Bacterial estimate: 30,000/g Coliform: 10/g
Dry whey	SPC: 30,000/g Coliform: 10/g	SPC: 30,000/g Coliform: 10/g	Bacterial estimate: 30,000/g Coliform: 10/g

SPC, standard plate count.

^a All counts expressed as "not more than."

^b Includes grade A dry whey and dry whey products.

sopic (DMC) procedures may be used. If using the latter, it must be understood that most whey processed is derived from cheese manufactured using bacterial cultures; thus, large numbers of viable lactic organisms are present in fresh whey. Except for the more heat-resistant strains of lactic bacteria, these organisms are not expected to survive pasteurization and are not detected by cultural techniques. However, when freshly dried whey is examined by direct microscopic techniques, cells of nonviable bacteria often stain. Therefore, results of DMC techniques used to assess the quality of dry whey must be interpreted with care.

Merin (1986), in a study of the microfiltration of whey using 1.2- μ m pore size membranes, reported that membranes reduced bacterial counts by one to three times and that increased fat content in the feed stream governed the decrease. Fat trapped on the membrane formed a barrier to microorganism penetration into the permeate.

REFERENCES

- American Dairy Products Institute. Standards for grades of dry milks including methods of analysis. Chicago, 1990, as revised.
- American Dairy Products Institute. Dry milk products. Utilization and production trends, 1998. Chicago, 1999a.
- American Dairy Products Institute. Whey products. Utilization and production trends, 1998. Chicago, 1999b.
- American Dairy Products Institute. Evaporated milk production. Chicago, 2000.
- Anderson PHR, Stone DM. *Staphylococcus* food poisoning associated with spray-dried milk. J Hyg 53:387, 1955.
- Armijo R, Henderson DA, Timothee R, Robinson HB. Food poisoning outbreaks associ-

- ated with spray-dried milk. An epidemiologic study. *Am J Public Health* 47:1093, 1957.
- Beard, BM, Sheldon, BW, Foegeding, PM Thermal resistance of bacterial spores in milk-based beverages supplemented with nisin. *J Food Prot* 62:484, 1999.
- Beardslee CE. Dry milks. The Story of an Industry. Chicago: American Dry Milk Institute, 1948.
- Bradshaw JG, Peeler JT, Corwin JJ, Hunt JM, Tierney JT, Larkin EP, Twedt RM. Thermal resistance of *Listeria monocytogenes* in milk. *J Food Prot* 48:743, 1985.
- Bradshaw JG, Peeler JT, Corwin JJ, Barnett JE, Twedt RM. Thermal resistance of disease associated *Salmonella typhimurium* in milk. *J Food Prot* 50:95, 1987.
- Clark WS Jr. Whey processing: history and development. In: Hui YH, ed. *Encyclopedia of Food Science and Technology*. New York: Wiley, 1991, pp 2845–2847.
- Clark WS Jr. Evaporated milk. In: Francis, FJ, ed. *Wiley Encyclopedia of Food Science and Technology*. 2nd ed. New York: Wiley, 2000a, pp 661–662.
- Clark WS Jr. Dry milk. In Francis, FJ, ed. *Wiley Encyclopedia of Food Science and Technology*. 2nd ed. New York: Wiley, 2000b, pp 540–542.
- Curran HR, Evans FR. Heat inactivation inducing germination in the spores of the thermotolerant and thermophilic aerobic bacteria. *J Bacteriol* 49:335, 1945.
- Donnelly CW, Briggs EH, Donnelly LS. Comparison of heat resistance of *Listeria monocytogenes* in milk as determined by two methods. *J Food Prot* 50:14, 1987.
- Doyle MP, Meske LM, Marth EH. Survival of *Listeria monocytogenes* during the manufacture and storage of nonfat dry milk. *J Food Prot* 48:740, 1985.
- Foster EM, Nelson FE, Speck ML, Doetsch RN, Olson JC Jr. *Dairy Microbiology*. Englewood Cliffs, NJ: Prentice-Hall, 1957.
- Gillies MT. *Whey Processing and Utilization*. Park Ridge, NJ: Noyes Data, 1974.
- Hammer BW, Babel FJ. *Dairy Bacteriology*. 4th ed. New York: Wiley, 1957.
- Higginbottom C. Bacteriological studies of roller-dried milk powders, roller-dried butter-milk and of roller- and spray-dried whey. *J Dairy Res* 13:308, 1944.
- Kalogridou-Vassiliadou D. Biochemical activities of *Bacillus* species isolated from flat sour evaporated milk. *J Dairy Sci* 75:2681, 1992.
- Langeveld LPM, van Spronsen WA, van Beresteijn ECH, Notermans SHW. Consumption by healthy adults of pasteurized milk with a high concentration of *Bacillus cereus*: a double blind study. *J Food Prot* 59:723, 1996.
- Marshall RT, ed. *Standard Methods for the Examination of Dairy Products*. 16th ed. Washington, DC: American Public Health Association, 1992.
- Merin U. Bacteriological aspects of microfiltration of cheese whey. *J Dairy Sci* 69:326, 1986.
- Miller DL, Goepfert JM, Amundson CH. Survival of salmonellae and *Escherichia coli* during the spray drying of various food products. *J Food Sci* 37:828, 1972.
- Nichols AA. Bacteriological studies of spray-dried milk powder. *J Dairy Res* 10:202, 1939.
- Rodriquez MH, Barrett EL. Changes in microbial population and growth of *Bacillus cereus* during storage of reconstituted dry milk. *J Food Prot* 49:680, 1986.
- Sienkiewicz T, Riedel CL. *Whey and Whey Utilization*. 2nd ed. Gelsenkirchen-Buer, Germany: Verlag Th. Mann, 1990.
- Theophilus DR, Hammer BW. Influence of growth temperature on the thermal resistance

- of some bacteria from evaporated milk. IA. Agr Exp Sta Res Bull No. 244, 1938.
- U.S. Department of Agriculture, Agricultural Marketing Service. Milk for manufacturing purposes and its production and processing; requirements recommended for adoption by state regulatory agencies. Federal Register 37:7046, 1972, as amended by FR 50:34726, 1985, and FR 58:86, 1993, and FR 61:48120, 1996. Washington, DC: U.S. Government Printing Office.
- U.S. Department of Health and Human Services, Food and Drug Administration. Code of Federal Regulations. Part 184. Direct food substances affirmed as generally recognized as safe. Federal Register 46:44439, 1981, as amended by FR 47:7410, 1982, and FR 54:24899, 1989. Washington, DC: U.S. Government Printing Office, 1999a.
- U.S. Department of Health and Human Services, Food and Drug Administration. Code of Federal Regulations. Part 131. Milk and cream. Washington, DC: U.S. Government Printing Office, 1999b, pp 275–276.
- U.S. Department of Health and Human Services, Food and Drug Administration. Code of Federal Regulations. Part 113. Thermally processed low-acid foods packaged in hermetically sealed containers. Washington, DC: U.S. Government Printing Office, 1999c, pp 216–242.
- U.S. Public Health Service. Grade A Condensed and Dry Milk Ordinance. Supplement 1 to the Grade A Pasteurized Milk Ordinance, 1995 Recommendations. Washington, DC: U.S. Department of Health and Human Services, Public Health Service, Food and Drug Administration, 1995.
- U.S. Public Health Service. Grade A Pasteurized Milk Ordinance. Publication No. 229. Washington, DC: U.S. Department of Health and Human Services, Public Health Service, Food and Drug Administration, 1997.
- Wandling LR, Sheldon BW, Foegeding PM Nisin in milk sensitizes *Bacillus* spores to heat and prevents recovery of survivors. J Food Prot 62:492, 1999.

4

Frozen Desserts

Robert T. Marshall

*University of Missouri
Columbia, Missouri*

I. INTRODUCTION

The temperatures at which ice cream is produced, stored, and served are below freezing, and microbial growth is of no concern. Because the viability of many microorganisms is preserved by freezing, this treatment is not expected to be lethal for microorganisms. Freezing and frozen storage are detrimental to some microorganisms, and these effects are discussed later in this chapter. Although ice cream itself does not suffer direct microbial spoilage, several ingredients of ice cream are susceptible to spoilage, because they are held at temperatures suitable for microbial growth.

A major concern of the ice cream industry is the potential for frozen desserts to be carriers of pathogenic microorganisms and of microbial toxins. Sources of disease producers and methods of protecting consumers from them are important topics for discussion in this chapter.

Some frozen desserts, particularly frozen yogurt, depend on microbial growth to produce typical flavor and textural characteristics. Some of the bacteria used in yogurt fermentation are thought to provide health benefits and are called probiotics. The beans used to produce vanilla and chocolate flavors are fermented by microorganisms under controlled conditions.

This chapter describes and defines frozen desserts, considers their major ingredients and the potential contribution of those ingredients to the microflora of the finished product, describes processing of mixes, and explores the freezing, storage, distribution, and serving of frozen desserts. Finally, regulations and quality assurance are discussed.

II. ENVIRONMENTAL SOURCES OF CONTAMINANTS

Outbreaks of foodborne disease from pasteurized dairy foods in the 1970–1985 period prompted the U.S. Food and Drug Administration (FDA) to launch the Dairy Product Safety Initiative in 1985. A part of this program was microbiological surveillance of finished products for pathogenic bacteria. Potential pathogens were isolated from samples collected in 70 (6.9%) of 1016 plants surveyed during the second year of the program. Among the isolates were *Yersinia enterocolitica* (3.2%), *Listeria* spp. (2.9%), and miscellaneous isolates of *Salmonella*, *Aeromonas hydrophila*, and other pathogenic species (0.8%). Positive test results were associated with postpasteurization contamination (U.S. Food and Drug Administration, 1987).

Klausner and Donnelly (1991) surveyed 34 dairy processing plants in Vermont, focusing on floors and other nonproduct surfaces. *Y. enterocolitica* and other strains of *Yersinia* were isolated from 10.5 and 2.5% of the sites, respectively. The incidence of *Listeria innocua* (16.1%) was high compared with that of *L. monocytogenes* (1.4%). Pathogens were significantly more likely to be found in wet than in dry areas ($P < .05$). This points to the importance of depriving microorganisms of water. Although sanitizing floor mats and foot baths are designed to reduce the incidence of transmission of bacteria by personnel, data from the study by Klausner and Donnelly indicate these devices may be sources of bacteria if they are not properly cleaned and refreshed with sanitizer.

A survey for listeriae in frozen milk product plants in California by Walker et al. (1991) revealed an incidence of 12% among 922 samples. Among the 39 plants sampled, *L. monocytogenes* and *L. innocua* were the single species recovered in 5 and 13 plants, respectively, and both species were recovered from 9 plants. No listeriae were isolated from 12 plants. A single species dominated at any particular site. Although floor drains have been major sources of *Listeria* in dairy plants, no isolates were made from drains in nine plants where they were present in other selected sites. The investigators suggested that increased awareness of high risks of drain-associated *Listeria* may have directed much attention to them even though other areas in the plant were neglected. Workers in Finland (Miettinen et al., 1999) monitored production environment, equipment, and ice cream from one plant during 1990–1997. Using pulsed-field gel electrophoresis, they identified 12 different endonuclease digestion patterns among the 41 isolates of *L. monocytogenes*. One strain persisted for 7 years. Samples became negative after the facility was modified structurally and cleaning and disinfection practices were improved.

Whereas confidential reports from industry laboratories indicate that it is not unusual to find listeriae in environmental samples, it is unusual to find them in finished product. The rationale for this is that hygienic practices common to the frozen desserts industry are effective in preventing transfer of pathogens from

the environment to pasteurized product. FDA enforcement reports for the years 1997–1999 record six recalls of ice cream and frozen yogurt products because of potential contamination with *L. monocytogenes* (FDA Enforcement Reports, <http://www.fda.gov/bbs/topicws/ENFORCE/ENF00498.HTML>). In contrast, there were 14 recalls of cheeses and cheese products because of contamination with *L. monocytogenes*. During the same time, there were recalls of frozen desserts for the reasons cited and of the following numbers, respectively: undeclared or unspecified nut ingredient, 16; undeclared color additive, 7; undeclared egg ingredient, 6; undeclared wheat or corn flour, 5; environmental contaminants (metal, calcium chloride, and ammonia), 4.

Recent studies of microbiological quality of frozen desserts have revealed varying numbers of undesirable bacteria. For example, Nichols and de Louvois (1995) reported that the microbiological quality of commercially produced ice cream in the United Kingdom has been generally good with the occasional outbreaks related to ice cream usually caused by *Salmonella* Enteritidis from raw eggs in noncommercial ice cream. However, nearly one-third of 46 samples of ice cream from markets in Ankara, Turkey, failed to meet Turkish standards of quality, and fecal coliforms were found in 15% of them (Kocak et al., 1998). Masud (1989) found that among 50 samples of commercial ice cream in the Pakistani market, 72% had total viable counts of more than 10^6 /g and 66% had coliform counts between 10^2 and 10^3 /g. Of 122 samples of vanilla ice cream manufactured by eight firms in Caracas, Venezuela, 43 and 77% failed to comply with international standards proposed for the aerobic plate count and Enterobacteriaceae count, respectively (de Tamsut and Garcia, 1989).

III. COMPOSITION AND CHARACTERISTICS

Ice cream is a frozen foam. The continuous phase is a viscous syrup that makes up 18–20% of the volume at 0°C. The suspended phase consists of tiny air cells, ice crystals, fat globules, and colloidal substances (principally casein and stabilizing gums). These components occupy about 45, 25, 5, and 3% of the volume, respectively, when the overrun is 90%. Microorganisms are also suspended in the continuous phase. Their viability is mainly affected by the pH, osmotic pressure, and their abilities to withstand high concentrations of salts plus the physical forces of ice crystals.

Freezing results in concentration of dissolved substances in the syrup. Substances detrimental to microorganisms include acids, salts, and, for some bacteria, sugars. In general, the order of survival of microorganisms in frozen desserts, ranked from highest to lowest survivability, is (a) bacterial spores, (b) spores of molds and yeasts, (c) gram-positive bacteria, (d) vegetative cells of molds and yeasts, and (e) gram-negative bacteria. Microbial toxins are resistant to freezing.

Ice cream contains from approximately 34 to 44% total solids. The most abundant component is carbohydrates, especially sugars. A typical full-fat formula may include 12% sucrose and 6% lactose as well as approximately 2% glucose and maltose from corn sweeteners. (These monosaccharides and disaccharides are listed as sugars in current nutritional labeling practice.) Additionally, such a formula includes approximately 4% higher saccharides from hydrolyzed corn starch. These carbohydrates lower the freezing point of the mix to about -3°C (26.6°F). The characteristic mix also contains approximately 1% ash, which is made up of minerals, especially calcium, magnesium, and phosphorus.

As ice is frozen out of the continuous phase, dissolved substances become increasingly concentrated, and the freezing point of this phase decreases. As the amount of available water decreases, pH also decreases, especially in the highly acidic products, frozen yogurt, sherbet, and sorbet, and osmotic pressure and viscosity increase. If heat is steadily and continuously removed, the cryohydric point of the least-soluble substance is reached ultimately. At this temperature, this substance starts to precipitate, and latent heat of fusion is released. Therefore, the rate of decline in temperature is slowed until that substance is precipitated. There is a large number of substances in ice cream that may precipitate; therefore, during freezing, rates of temperature decline are not expected to be constant once eutectic points begin to be reached.

An unstable rate of decrease in temperature of ice cream being frozen is not expected to be a factor in survival of microorganisms, but formation of crystals and increasing concentrations of salts are likely to be detrimental. Salts tend to destabilize proteins and lipoproteins, and renaturation of them on thawing does not always occur. This is especially important for permeases that are located on the exterior of the cell. Sugars, however, may protect microorganisms from injury by freezing. Luyet (1962) suggested that microorganisms that best survive freezing are those that are able to dehydrate themselves most rapidly. Such cells are able to reduce the number of intracellular ice crystals that form, crystals that may puncture the cytoplasmic membrane.

Others have shown that cold-shock proteins are produced by some bacteria and that these have a protective effect against freezing. The temperature that stimulated production of the proteins varied with the bacterium: 4°C with psychrotrophic *Pseudomonas fluorescens* KUIN-1 (Obata et al., 1998); 10°C with *Lactococcus lactis* ssp. *cremoris* (Broadbent and Lin, 1999) and with *Salmonella* Enteritidis (Jeffreys et al., 1998); 20°C with *Streptococcus thermophilus* CNRZ302 (100-fold increase in survival after four freeze-thaw cycles compared to mid-exponential phase cells grown at 42°C) (Wouters et al., 1999); 25°C with *Lactobacillus acidophilus* (Lorca, 1998).

L. monocytogenes, which is notably resistant to cold temperatures, contains an unusually high proportion of branched chain fatty acids ($>85\%$). Furthermore,

cells grown at 6°C contained about one-third more total lipid than did those grown at 30°C. Ratios of neutral lipids to phospholipids and of anteiso-15 to anteiso-17 fatty acids were considerably higher in the cells grown at the lower temperature (Mastronicolis, 1998).

Enzymes of bacteria able to grow in the cold have a relatively high turnover number and catalytic efficiency, but they suffer high thermosensitivity. Their highly flexible structure enables them to undergo conformational changes during catalysis. The weak interactions involved in protein stability are either reduced in number or modified to provide this high flexibility (Feller and Gerday, 1997; Gerday et al., 1997). These characteristics make the enzymes more susceptible to heat denaturation, which is one of the reasons that psychrotrophic bacteria are readily destroyed by pasteurization.

The quantity of milk fat in ice cream ranges from less than 0.5% to more than 16%. Milk fat is an insulator in that it slows the rate of heat transfer through the frozen foam. Air cells, which may constitute up to one-half of the volume of ice cream, are also insulators. Both fat globules and air cells restrict growth of ice crystals. In so doing they reduce the amount of damage done to microbial cells by extracellular ice.

Colloidal substances that associate with water through hydration reduce the amount of water to be frozen, thus reducing the size and number of extracellular ice crystals. It is expected, therefore, that chances of survival of microorganisms are enhanced as increasing concentrations of colloidal substances are included and free water content is decreased in ice cream mixes. Furthermore, freezing causes cells to dehydrate, thus decreasing the amount of available water to form intracellular ice. Gases dissolved in the cytoplasm are lost. These events cause the viscosity of cellular matter to increase, thus slowing molecular interactions.

In frozen yogurt, the concentration of lactic acid is expected to vary from 0.1 to 0.2% of the total weight of the mix. As a percentage of the weight of the unfrozen aqueous phase at the temperature of storage of ice cream, -20°C, lactic acid may constitute 1–2%. Depending on the buffering capacity of the mix constituents, the pH in the microenvironment of the microbial cells of the ice cream may be detrimental to viability of the cells.

IV. INGREDIENTS

A. Milk and Milk Products

Raw milk and cream are likely to contain the following pathogens sporadically but consistently when milk is assembled from numerous farms to a single large facility: *Campylobacter jejuni* (and other campylobacteria), *Salmonella* Dublin

(and other salmonellae), *Escherichia coli* (at times including pathogenic strains), and *L. monocytogenes*. Animals used for food production are infrequent carriers of these bacterial pathogens and a few others.

Ryser and Marth (1991) summarized results of tests of raw milk in the United States, Canada, and Europe, finding 3.1, 2.7, and 4.1%, respectively, of the samples contaminated with *L. monocytogenes*. However, numbers commonly found in raw milk are seldom more than 10/mL. Sources of *Listeria* in raw milk include infected mammary glands, poorly fermented silage, and soil. This bacterium is generally considered to be transmitted by nonzoonotic means (Kozak et al., 1995).

Raw fluid milk and cream spoil relatively rapidly. In general, raw milk is delivered from producing farms to processors within 40–72 h of production and is not permitted to be held for more than 72 h in the receiving dairy before processing. Most manufacturers process raw milk much sooner than the maximal time the system permits. It is important to do so to minimize risks of spoilage by psychrotrophic bacteria, especially members of the genus *Pseudomonas*. These bacteria are prolific producers of hydrolytic enzymes, including proteinases (Mayerhofer et al., 1973), lipases (Christen and Marshall, 1983), phospholipases (Fox et al., 1976), and glycosidases (Marin and Marshall, 1983). Many of the proteinases, phospholipases, and lipases retain their activity after pasteurization. Some can be inactivated at the relatively low temperatures of 40–60°C (Marshall and Marsteller, 1981; Christen and Marshall, 1985).

Concentrated milks, commonly known as condensed milk and condensed skim milk, are widely used as ice cream ingredients. Concentrated milk products are almost always pasteurized before or during the concentration operation. Therefore, the incidence of microbial pathogens in these products is practically nil, and they have the microbiological keeping quality of pasteurized milk. Concentrated whey has similar characteristics. Bulk sweetened condensed milk and skim milk are prepared with sufficient sugar (approximately 42%) to prevent outgrowth of most spoilage bacteria. Furthermore, the evaporative process by which they are concentrated uses heat sufficient to destroy most vegetative forms of microorganisms. Therefore, they can be shipped and stored for limited periods without refrigeration.

Dry dairy ingredients include nonfat dry milk, dry buttermilk, dry whey, and whey protein concentrate. Processing commonly involves pasteurization, concentration, and drying. The heat of these processes kills most of the vegetative microorganisms; therefore, viable bacteria recoverable from them usually are mostly spore formers. Major advantages to the use of dried dairy ingredients are their storability and low weight per unit of solids. The latter factor reduces the cost of transportation, whereas the former provides maximal flexibility in use and helps balance supply with demand.

B. Sweeteners

1. Crystalline and Granular Sweeteners and Bulking Agents

Sucrose, dextrose, and fructose are available in both crystalline and syrup forms. Few microorganisms are contained in crystalline sweeteners. Maltodextrins, polydextrose, and corn syrup solids are available in granular form. Some of these materials may carry viable microorganisms, usually yeasts. Bottler's standards for 10-g samples of granulated sugars are less than 200 mesophils, 10 yeasts, and 10 molds (National Soft Drink Association, 1975).

2. Syrups

In addition to sucrose, dextrose, and fructose, corn sweeteners are available as syrups. Because syrups contain water and provide energy, they may support growth of osmophilic fungi. These microorganisms, usually being highly aerobic, grow on surfaces. They can be killed by exposure to ultraviolet light and their growth can be inhibited by sealing full containers in which they are packed. This is not practicable when the container is a tank into which air must be admitted to displace syrup as it is drawn out during use. For them to flow steadily, syrups must be kept warm in pipelines that are used to transfer the sweetener to the batching tank for making mixes. Therefore, it is critical that the concentration of solids in the syrup be so high as to inhibit growth of the most osmophilic yeasts that might be contained. The usual solids concentration of these syrups is 71–82%, making the water activity (a_w) approximately 0.80. Syrups with a high dextrose equivalent (DE) are significantly more microbiologically stable than those with a low DE; for example, 62 DE versus 36 DE. The sugar concentration, measured in Brix, ranges from 67 to 86°, depending on the sweetener. Smaller sugar molecules exert greater osmotic pressure than larger ones given the same weight concentration. Therefore, concentrations of glucose, fructose, sucrose, and maltose necessary to limit microbial growth are lower than for corn syrups, which contain polymers of glucose that are products of incomplete hydrolysis of starch. High-fructose corn syrups of 42 and 55% have a_w values of 0.75 and 0.68, respectively (L. True, personal communication, 1997).

Osmotolerant yeasts can grow at a_w of less than 0.85. Even syrups with an a_w as low as 0.65 have been found to support growth of osmophilic yeasts (Troller, 1979). Most of these are in the genus *Zygosaccharomyces* (Walker and Ayres, 1970). Other genera of yeasts reportedly found are *Candida*, *Pichia*, *Schizosaccharomyces*, and *Torula*.

Condensate formation in syrup storage tanks raises the a_w and gives fungi opportunities to grow. Condensate accumulation can be prevented by forcing filtered and ultraviolet-treated air over the surface of the syrup.

In the preparation of corn syrups, the steps of steeping, wet milling, washing, purifying, and drying have a potential effect on microbial growth and survival. During steeping, corn is soaked in water at 45–50°C for 48 h at a pH of approximately 4 (Whistler and Paschall, 1967). During this period, the mixture is susceptible to growth of microorganisms that produce alcohols and butyric acid. A common microbial inhibitor added during steeping is sulfur dioxide (0.1–0.2%).

Typical manufacturer's maximal standards for microorganisms in syrups follow: aerobic plate count, 100/g; yeasts, 20/g; molds 20/g; *E. coli*, none in 30 g; and *Salmonella*, none in 100 g.

C. Honey

Honey is sometimes used in frozen desserts in the dual role of sweetener and flavoring agent. A typical concentration of honey in honey-flavored ice cream is 9%. Yeasts are likely contaminants of honey, because flowers from which the nectar is derived are the habitat of yeasts. Several species of *Zygosaccharomyces* have been isolated from defect-free and fermented honeys (Walker and Ayres, 1970). Because of its high hygroscopicity and viscosity, unprotected honey tends to develop areas (gradients) in which the a_w is high enough to permit yeast growth.

D. Flavorings

Pure synthetic or natural flavorings vary widely in content of microorganisms. Flavorings that are heat sensitive cannot be given a lethal heat treatment. Those that are low in viscosity and contain no suspended matter can be filter-sterilized. Some are naturally antagonistic to microbial growth, especially those that have an alcohol base. Most are used in such small quantities that their contribution to the bacterial load is insignificant. Most are added after pasteurization, making it critical that they contain no pathogens.

1. Extracts

Alcohol is used to extract flavorful substances, such as vanilla, that are used to add flavor to frozen desserts. Pure vanilla is required to contain at least 35% ethanol to be labeled vanilla extract. This concentration of alcohol is sufficient to dehydrate and destroy most vegetative microbial cells. Other extractants include ethylene and propylene glycols.

2. Chocolate

Cacao beans are fermented before being ground and pressed to separate some of the cocoa butter from the cocoa. Grinding alone produces chocolate liquor,

whereas pressing and grinding yields cocoa and cocoa butter. The latter contains only minor flavor notes, whereas the chocolate flavor is carried in the cocoa. Cocoa powders contain from 10 to 24% cocoa butter (fat) unless they have been extracted with a solvent. The microflora of uncontaminated cocoa and chocolate liquor consists nearly exclusively of bacterial spores and numbers are usually less than 100/g.

E. Fruits

Fruit ice creams represent approximately 15% of the total market.

1. Fresh and Frozen

Frozen fruits, especially berries, have been widely used in the frozen desserts industry for many years. Freezing tends to disrupt the structure and destroy the turgidity of fruits. On thawing, fruits become soft, juices escape from the cells, and color fades.

Because of the relatively low pH of fruits, the microflora of fresh and frozen fruits is dominated by yeasts, including the genera *Saccharomyces* and *Cryptococcus*, and by molds, including species of *Alternaria*, *Aspergillus*, *Botrytis*, *Fusarium*, *Geotrichum*, *Mucor*, *Penicillium*, and *Rhizopus*. Small numbers of soil-borne bacteria are present also, including species of *Bacillus*, *Pseudomonas*, and *Achromobacter*. These bacteria do not compete well with the fungi in the pH range common to fruits. However, some lactic acid bacteria as well as species of *Acetobacter*, *Gluconobacter*, and *Zymomonas* may develop in the acidic environment of the fruit processing plant.

A principal source of pathogens in fresh and frozen fruits is persons who pick and handle them. Insects also may contaminate fruits. Peeling, washing, and blanching are processes that lower numbers of microorganisms on raw fruits. A major recall of frozen strawberries was initiated in March 1997 when they were associated with an outbreak of hepatitis A in Michigan. The recall was extended to frozen strawberry fruit bars and to strawberry ice cream containing the same pack of berries that originated in California (FDA Enforcement Reports, 1997).

Freezing kills some microorganisms on fruits but is not a dependable lethal process. Furthermore, it is not feasible from a quality viewpoint to blanch most fruits (except peaches) to destroy microorganisms. However, bactericidal chemicals, such as hypochlorite, may be added to wash water to reduce numbers of microorganisms on surfaces. Antioxidant dips are frequently applied to minimize browning. These include ascorbic acid, sulfur dioxide, and sugar syrup. Sulfur dioxide has some antimicrobial effect, and syrups may kill organisms that are susceptible to high osmotic pressures.

2. Processed

With the advent of highly effective heating and aseptic packaging processes, mostly aseptically processed fruits are used. In general, steam under pressure is not needed to destroy the microflora of fruits, because they are acidic, and heating at 100°C or less is adequate. The more acidic the fruit, the lower the heat treatment required to preserve it. Among the fruits often used in frozen desserts, peaches and apricots fall within the “acid foods” range of pH 3.7–4.5, whereas berries have a pH less than 3.7, placing them in the “high-acid foods” group.

Fruits that are aseptically processed can be stored at room temperature for several months with no microbial spoilage. Processors frequently use swept-surface heat exchangers that heat the mixture of fruit, sugar, acid, and stabilizer to 88–121°C, depending on the fruit. After holding the mixture for approximately 3 min at the maximal temperature, it is cooled to approximately 27°C and pumped directly to an aseptic filling machine. It is filled into sterile containers that are usually made of laminated polyethylene and foil.

In an alternative processing system (Fig. 1), fruit is pumped through coils that heat, hold, and cool the product. The coils cause the fruit to mix well in the

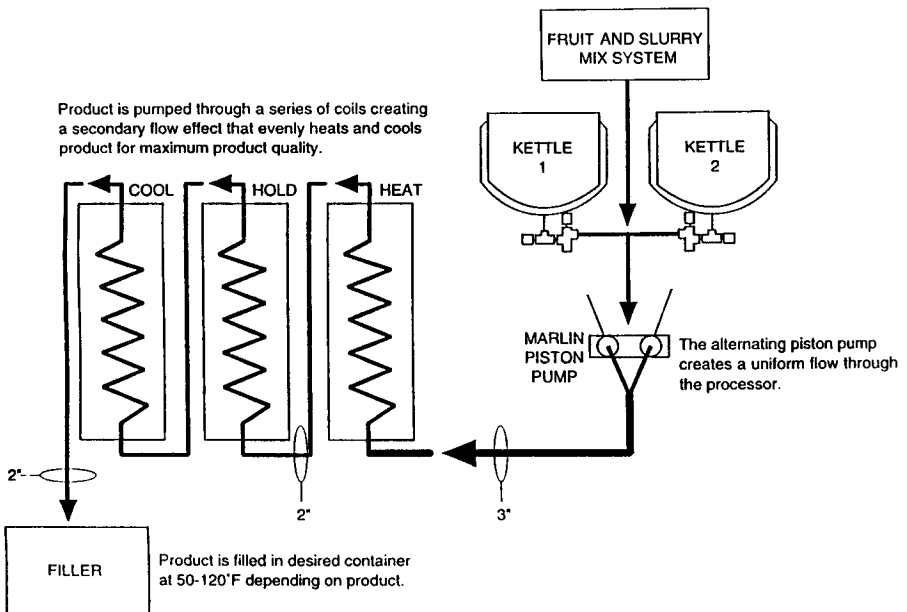

Figure 1 Aseptic processing system for fruits. (Courtesy of Lyons Magnus, Fresno, CA.)

tubes so that scrapers are not needed; therefore, little damage is done to the integrity of the fruit. Yet, microbial cells are efficiently and effectively destroyed.

Processing in open kettles permits heating to a maximum of a few degrees above 100°C (sugar in the fruit raises the boiling point) and extends needed holding time to at least 20 min. Volatile substances are able to escape the fruit, changing the flavor, and color usually darkens. Shelf life is often short, and refrigeration is needed to preserve the product.

Typical microbial specifications for fruit flavorings follow:

Process	APC/g	Yeast and mold/g	Coliforms/g
Cool fill	5000	100	10
Hot fill	1000	100	<1
Aseptic pack	100	10	<1

APC, aerobic plate count

3. Candied

Sugar is added to fruits before they are added to ice cream. The usual fruit to sugar ratio ranges from 2:1 to as high as 9:1. Candied and glacéed fruits have sugar concentrations high enough to lower the a_w below the level that permits microbial growth. Candying is accomplished by treating fruits with syrups having progressively higher sugar concentrations to prevent the exterior from becoming tough or leathery while the interior remains soft. Following impregnation with sugar, the fruit is washed to prevent crystallization of sugar on the surface and is then dried. To make glacéed fruit, candied fruit may be dipped into syrup and dried again.

F. Nuts

Nuts carry with them from the fields a wide array of microorganisms, many of which have their origin in soil. Some are contaminated with excreta from animals, birds, and insects. Various treatments are given nuts and nut meats in separating the nut meats from the shells. Most of these treatments lower microbial numbers in the nut meats. For example, sorting of lightweight pieces from the heavier nuts removes much of the dust that carries microorganisms. Flotation in water is used with pistachios to remove immature fruits and with pecans to remove fragments of shells. Blanching in hot water loosens pellicles from almonds and peanuts, and some nuts are salted in a brine solution. Treatments with water can remove microorganisms, but they can also elevate a_w , and reuse of water results

in increasing populations of microorganisms that can be spread to other nuts. Therefore, frequent changes of water are needed.

Low a_w is the major limiting factor in preservation of nut meats; therefore, drying is required to prevent mold growth if harvested nuts are not sufficiently dry. Moisture content of tree nuts normally ranges from 3.8 to 6.7%. Thus, the a_w is usually less than 0.70 and microbial growth does not occur (Beuchat, 1978). Microorganisms usually die during storage. High temperatures and a_w just below the level sufficient for growth are factors that increase death rates of microorganisms (King and Shade, 1986).

Because of the wide variety of nuts, the different environments they come from, and the several treatments given them, types and numbers of microorganisms present on nuts vary widely. Counts range upward to several thousand per gram, and insect-damaged nuts carry more microorganisms than undamaged ones (King et al., 1970). Nuts harvested from orchards where farm animals have been kept have an increased likelihood of contamination with *E. coli*. However, neither tree nuts nor ground nuts are considered to be likely vehicles of pathogenic microorganisms. Treatments with propylene oxide, permitted on tree nuts but not on peanuts, destroys most of the residual microflora (Beuchat, 1973; USHEW, 1978). Roasting, a treatment given peanuts and some other nuts, destroys vegetative cells of microbes.

Mycotoxins, especially aflatoxins, are of concern because of the chance of mold growth on nuts that contain high amounts of moisture. Nut meats removed from refrigeration can have condensate form on them, especially when placed in areas of high humidity. If these nuts are not used soon and are stored at favorable temperatures, molds are likely to grow on them.

G. Confections and Bakery Products

Confections and baked goods are low in bacterial numbers and seldom carry pathogenic bacteria. Methods of preparation and very low a_w greatly limit survival and growth of microorganisms. However, these ingredients are usually added after freezing so that any contaminants they carry are given no positively lethal treatment.

H. Eggs and Egg Products

The ice cream industry uses egg yolks primarily for their flavor in the manufacture of French vanilla ice cream (also known as frozen custard; 1.4% egg yolk solids required) and in parfaits. Egg yolk is used also as a source of emulsifying and stabilizing agents, because egg yolk contains a high amount of lecithin. Sorbets usually contain 2.5–3% egg white. Pasteurized egg yolk is commercially available in three forms, liquid, frozen, and dried, that are useful in manufacture

of frozen desserts. Egg white is available in dry and frozen forms. It is also possible to break and separate yolks from albumen of fresh shell eggs; however, this is usually feasible and economical only in production of small batches of ice cream.

Addition of 10% sucrose to egg yolks is effective in preventing gelation that occurs during storage of frozen yolks. Gelation of frozen plain yolk occurs most rapidly at approximately -18°C . Sugar is usually added to both the liquid and frozen forms. Salt also prevents gelation of egg yolk and is effective at approximately 2% concentration, but the salty flavor is undesirable in frozen desserts, making the sugar form the product of choice if frozen yolks are used.

The interiors of shell eggs (eggs in the shell) are usually sterile (with the possible exception of harboring certain salmonellae) at the time of laying (Brooks and Taylor, 1955; Morris, 1989). However, the shells of eggs become contaminated with several thousand to millions of bacteria during laying, collection, and processing.

Normally, 10–20 days pass between the time an egg is contaminated and the time when there is a significant increase in bacterial numbers inside the egg. One reason is that little iron is available at the shell membranes and in the albumen, and most bacteria require iron for growth. Glycoproteins of the membrane fibers bind iron tightly. Ovotransferrin, a protein of the albumen (white), also chelates iron. Certain species of *Pseudomonas* produce an iron chelate, pyoverdine, that has been claimed to scavenge iron from ovotransferrin (Board and Tranter, 1995). Thus, they are able to overcome one of the major barriers to growth in egg albumen. Chemotaxis played a role in movement of *Pseudomonas putida* and *Salmonella* Enteritidis toward yolk surfaces (Lock et al., 1992). The chemical attractant was not identified.

Additional hurdles that microbes face in the albumen of the shell egg involve binding of biotin by avidin (Chignell et al., 1975) and of riboflavin by ovoflavoprotein (Clagett, 1971). Bacteria that require either or both of these vitamins would, therefore, be inhibited in albumen of the egg. Furthermore, the highly alkaline (pH 9.5) albumen contains lysozyme, an enzyme that can lyse the cell membrane of certain gram-positive bacteria. Once a bacterium has reached the yolk of the egg, inhibitors are of no effect and nutrients abound, so growth can proceed rapidly.

Fresh eggs are seldom used in ice cream except in small operations. Because of the relatively high risk of the presence of salmonellae on and in fresh eggs, it is important that egg breaking be done in a room separate from the freezing and filling rooms. Furthermore, all eggs must be pasteurized if they are added to a frozen dessert after the mix is pasteurized. The FDA reported three recalls of liquid whole eggs for contamination with salmonella bacteria in the 1997–1999 enforcement reports (FDA Enforcement Reports, 1997, 1998, 1999).

Micrococci are nearly always present on freshly laid eggs, but spoilage of

shell eggs is nearly always caused by gram-negative rods, especially species of *Pseudomonas* and *Proteus* (Board and Tranter, 1995).

Samples of unpasteurized liquid egg from commercial egg breakers have been reported to range in aerobic plate count from 10^3 to 10^6 /g (Froning et al., 1992). Although the number of salmonellae in unpasteurized liquid eggs is usually less than one per gram, the risk that these organisms may be present is significant. Recently, the incidence of contamination of eggs with *S. enteritidis* through transovarian infection has caused considerable concern. *S. enterica* serovar Enteritidis, commonly known as *S. Enteritidis*, has adapted to survive in the hen's internal organs from which it is occasionally deposited into the contents of an egg. A conservative estimate of the average incidence of infection across the United States is 1:20,000 eggs (American Egg Board, 1999). Foodborne illnesses from *S. Enteritidis* have been on the decline in the United States since 1995.

Most manufacturers use pasteurized egg products, including liquid whole egg, frozen sugar egg yolk, or dried egg yolk. Approved pasteurization standards for egg products produce 6–8 \log_{10} reductions in numbers of *Salmonella* (Speck and Tarver, 1967; Shafi et al., 1970). All pasteurized egg products should meet the following microbiological limits: aerobic plate count, less than 10,000/g; coliform count, less than 10/g; yeast and mold count, less than 10/g; and salmonellae, negative in 25 g.

Freezing reduces numbers of viable microorganisms in egg products (Winter and Wilkin, 1947). Although most species of bacteria survive freezing in some numbers, the major survivors of both pasteurization and freezing are *Bacillus*, *Micrococcus*, and *Enterococcus* (Wrinkle et al., 1950; Froning et al., 1992). *Salmonella* Oranienburg survived storage in frozen yolk (Cotterill and Glauret, 1972).

I. Coloring Materials

Coloring materials are often added to frozen dessert mixes after pasteurization; therefore, it is important that colorants be free of pathogens and low in total numbers of microorganisms. The following are typical microbiological specifications for food, drug, and cosmetic (FD&C) dry powders, blends, granulars, and FD&C lakes and lake blends: aerobic plate count less than 1000/g; coliforms, less than 10/g; yeasts and molds, less than 100/g; *E. coli* or *Salmonella*, negative in 25 g. Most firms do not test each batch for microbial counts but are willing to arrange for batch certification by an independent laboratory.

Colors and lakes provide very limited nutrients for growth of microorganisms, and, when sold in the liquid form, they contain low concentrations of benzoates as preservatives. When purchased in the powder or granular form, the water and containers used in hydrating them should be practically sterile. The water

should be free of sources of nitrogen and energy that might enable microorganisms to grow. When rehydrated colorants are to be kept for several weeks, it is advisable to store them refrigerated.

J. Spices

Spices can carry widely varying numbers and types of microorganisms. Spore formers are especially prone to be present and to survive over long periods. Spices, like nuts, can be treated with ethylene oxide to reduce the microbial load. Furthermore, spices can be irradiated to kill microorganisms.

Cinnamon contains cinnamic acid, a microbial inhibitor. However, dilution of cinnamon with ice cream mix greatly reduces this antimicrobial effect.

V. FROZEN YOGURT

A. Composition and Properties

Consumers often choose to eat frozen yogurt because they expect that it will contain less lactose than ice cream containing a similar amount of fat, and because they expect some benefit from the viable bacteria contained in the yogurt. Therefore, it is important to consider how much lactose is fermented to lactic acid during preparation of the mix, how many viable cells reside in the product, and how much galactosidic (lactase) activity those cells retain.

Frozen yogurt has a composition similar to low-fat ice cream. However, there is no Standard of Identity for frozen yogurt. The labeling regulations based on content of milkfat are the same as for ice cream. The unique characteristic of frozen yogurt is that it contains cultures of *Streptococcus thermophilus* and *Lactobacillus delbrueckii* ssp. *bulgaricus*. The shorter name, *L. bulgaricus* is usually used for the latter bacterium.

These two bacteria are typically grown together in skim milk fortified with 1–4% added nonfat milk solids. Therefore, the nonfat milk contains about 6.5% lactose, and about 1.2% of it is converted to lactic acid during fermentation. This fortified skim milk is heated to approximately 85°C for 5 min and cooled before inoculation. Temperature of incubation is high, approximately 42°C, so generation time and, consequently, incubation time are short. From 10 to 20% of the finished and cooled yogurt is added to the processed and aged base mix at the time flavoring and coloring agents are added. Freezing follows.

It is also possible to add the yogurt culture to the base mix, which is then incubated until the titratable acidity, expressed as lactic acid, reaches approximately 0.30%. However, this process involves cooling the mix after pasteurization to the incubation temperature, then completing the cooling of the full batch, and holding it to permit aging. Therefore, time of production is longer and the

capacity of the fermentation tank must be larger than with the previously described method.

The product is frozen in the same way as ice cream, and the overrun is typically in the range of 70–100%. Freezing kills many of the streptococci and lactobacilli of the yogurt culture. Sheu and Marshall (1993) observed that numbers of viable *L. bulgaricus* of two strains decreased approximately 45 and 90% during the continuous freezing of a simulated frozen yogurt mix. Viable cell numbers decreased approximately 5% more during storage at -20°C for 2 weeks after freezing. However, when the same two cultures were entrapped in beads (average diameter $<18\ \mu\text{m}$) of calcium alginate gel, viable counts were approximately 45% higher than those of the nonentrapped cultures (Fig. 2). Cells of the strain of *L. bulgaricus* that were most susceptible to freeze damage were much larger than those of the smaller strain, suggesting that stresses of freezing are more damaging to large than to small cells.

Researchers have shown that exopolysaccharide (capsules) on bacteria renders cells comparatively resistant to thermal and physical shock (Robinson, 1981). Hong (1995) isolated three nonencapsulated mutants of *S. thermophilus*

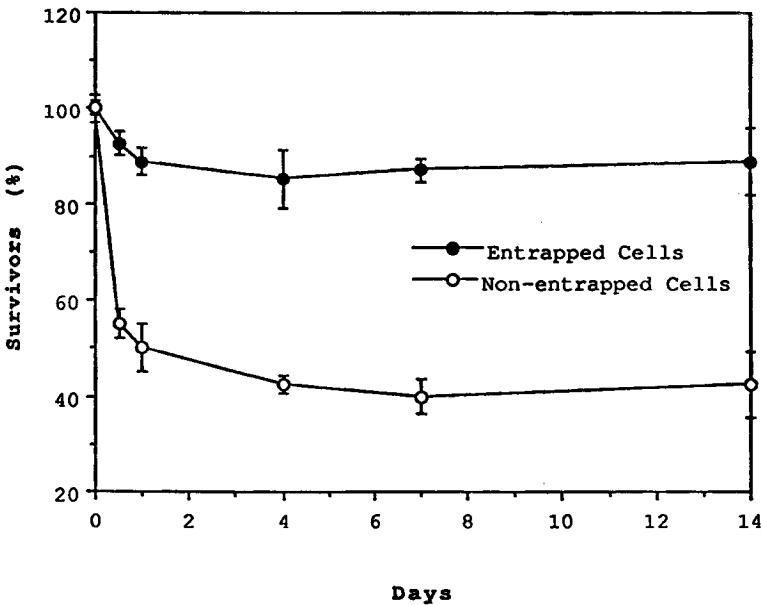

Figure 2 Numbers of survivors among *Lactobacillus delbrueckii* ssp. *bulgaricus* enrobed in calcium alginate. (From Sheu and Marshall, 1993.)

and compared them with the encapsulated parental strain for abilities to withstand freezing under a variety of conditions. The parent and mutant strains did not respond differently when frozen without agitation. However, freezing to -7°C with agitation in a batch freezer and hardening to -29°C resulted in survival of 28% of the encapsulated and only 17% of the nonencapsulated strains (Fig. 3). Early log phase cells were more sensitive to freezing than late log phase or stationary phase cells. Cell viability after batch freezing was unaffected by (a) culture growth temperatures between 40 and 45°C , (b) fat content between 5 and 14%, or (c) neutralization of the acid produced by the cells during growth in skim milk. *S. thermophilus* survived significantly better in reduced-fat ice cream frozen in a continuous freezer to 50% overrun than in the same mix frozen to 100% overrun. The added agitation and scraping of the freezer barrel walls needed to attain higher overrun may have been responsible for the lowered rate of survival. Additional oxygen whipped into the mix might have increased cellular exposure to free radicals and thus increased the death rate. However, no significant difference was found between numbers of survivors when the gas

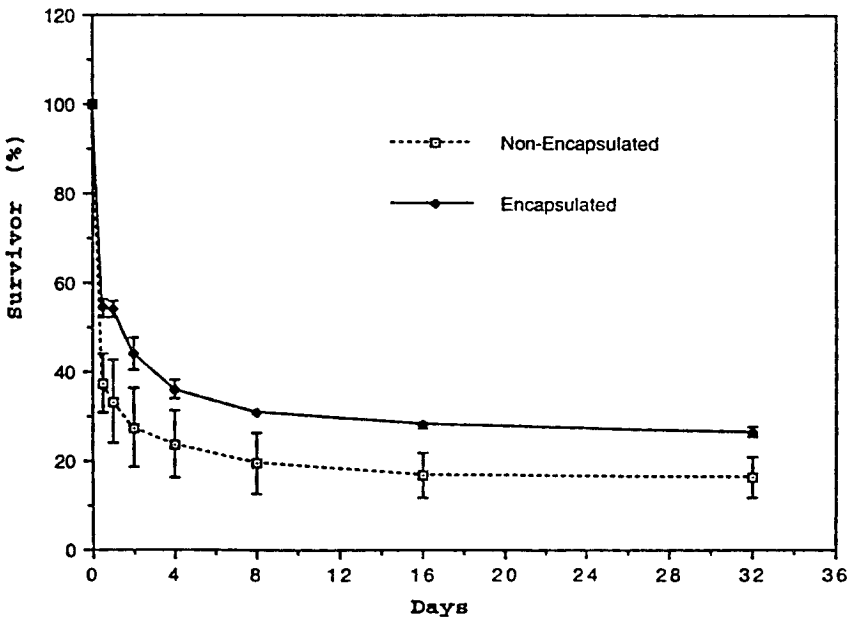

Figure 3 Numbers of survivors among encapsulated and nonencapsulated strains of *Streptococcus thermophilus* subjected to freezing in nonfat ice cream mix by a batch freezer. (From Hong, 1995.)

whipped into the ice cream was nitrogen or air. Storage of the frozen ice cream at -23 or -29°C resulted in significantly more survivors than storage at -17°C .

B. Probiotic Nature

Although it was 1908 when Eli Metchnikoff suggested that certain bacteria in the human intestine could prolong the life of persons who consumed them in their foods, only recently have food microbiologists coined the term *probiotic* and have selected specific bacteria to add to foods as dietary adjuncts. The inference of the word *probiotic* is that a microorganism confers a positive effect on a biological entity, most importantly on human life. Most bacteria thought to have a probiotic effect are part of the natural microflora of the human intestine. Many of them are also useful as starter bacteria in food fermentations. *Prebiotic* is a term coined to describe substances needed to support the growth of probiotic microorganisms.

Benefits to consumers of fermented dairy foods and of those to which dietary adjunct bacteria are added include the following: (a) improved nutritional qualities (synthesized vitamins and enzymes as well as hydrolyzed proteins), (b) competitive exclusion of infective bacteria, (c) production of antibacterial substances (Shahani et al., 1977), (d) enhanced antibody production, (e) moderated response to endotoxin, and (f) anticarcinogenic activity.

Humans influence the nature of the intestinal microflora in several ways. Salivary, gastric, and intestinal secretions, bile, and mucus provide selective environmental factors. The stomach is strongly acidic, but pH increases as food moves to the distal end of the large intestine. Intestinal motility moves both food and microorganisms along the gastrointestinal tract, expelling billions of bacteria daily. Oxidation reduction potential is also a selective force. In general, the greater the distance intestinal contents travel from the stomach, the higher their microbial numbers.

Fermented dairy foods usually contain viable cells of the bacteria used as starter. Commonly used starter cultures contain lactococci, streptococci, lactobacilli, or leuconostocs. Some species of these genera have been shown to affect consumers favorably.

Frozen yogurt is the most popular dessert made from fermented milk. Most manufacturers produce frozen yogurt by adding 10–20% of plain yogurt to a pasteurized low-fat ice cream mix. Flavoring is then added just before the mix is frozen. Assuming $5 \times 10^8/\text{g}$ of viable *S. thermophilus* and *L. bulgaricus* in the plain yogurt and addition of 20% yogurt to the mix, the number of yogurt bacteria in the mix before freezing would be $10^8/\text{g}$. If freezing were to kill 50% of the yogurt bacteria, the viable number remaining would be $5 \times 10^7/\text{g}$. This large number of viable cells may provide benefit to consumers. Lopez et al.

(1997) stored three batches of commercial frozen yogurt at -23°C for over 1 year. The numbers of lactic acid bacteria, which exceeded $10^7/\text{g}$ initially, decreased only slightly during the storage period. A strong correlation ($r^2 = 0.62$) existed in 11 brands of frozen yogurt between β -galactosidase activity and numbers of lactic acid bacteria (Schmidt et al., 1997).

Additionally, frozen desserts can be used as carriers of dietary adjuncts. Modler et al. (1990) used ice cream as a carrier for three species of bifidobacteria. At the end of 70 days of storage at -17°C , viable counts of these bacteria had decreased only 10%. Bifidobacteria have been receiving major attention as potential dietary adjuncts. These anaerobic, nonmotile, nonsporing, gram-positive, bifurcated (γ -form) or curved rods produce acetic acid and L(+) -lactic acid as they ferment sugars. They comprise nearly 100% of the microflora in the stools of healthy breast-fed infants but only 30% to 40% of stool flora of formula-fed infants (Jao et al., 1978). As humans age, the percentage of bifidobacteria in stools decreases to low values. Their growth can be stimulated by oligosaccharides (Gyorgy et al., 1974), including β -linked N-acetylglucosaminides (Zilliken et al., 1955), glycoproteins (Bezkorovainy et al., 1979), and cysteine-containing peptides of kappa-casein (Poch and Bezkorovainy, 1991). Therefore, some foods are being supplemented with such "prebiotic" substances with the intention of enhancing growth of bifidobacteria in the human intestine.

Hekmut and McMahon (1992) fermented a representative ice cream mix with *L. acidophilus* and *Bifidobacterium bifidum* and then froze it in a batch freezer. Counts of *L. acidophilus* dropped from $1.5 \times 10^8/\text{g}$ immediately after freezing to $4 \times 10^6/\text{g}$ after 17 weeks, whereas those of *B. bifidum* dropped from $2.5 \times 10^8/\text{g}$ to $1 \times 10^7/\text{g}$ during the same period. Coincidentally, β -galactosidase activity dropped by about 25%. Freezing caused a loss in viable cell numbers of $0.7\text{--}0.8 \log_{10}$ in ice cream inoculated with four strains of probiotic bacteria (*L. reuteri*, *L. acidophilus*, *L. rhamnosus*, and *B. bifidum*). However, during 1 year of frozen storage, counts did not drop significantly and all remained above $10^6/\text{g}$ (Hagen and Narvhus, 1999). Incorporation of glycerol in the ice cream did not improve survival. In another study (Ravula and Shah, 1998), 10 strains of *S. thermophilus* and 7 of *L. bulgaricus* along with probiotic bacteria (13 strains of *L. acidophilus* and 11 strains of bifidobacteria) were screened for abilities to survive freezing at -18°C when the pH was 4.5 or 4.0 and sucrose levels were 8 and 16%. Counts of the yogurt bacteria decreased about $1 \log_{10}$ during the first 3–5 weeks and then remained fairly constant. However, probiotic strains varied widely in response, with some losing up to $6 \log_{10}$ cycles in numbers of recoverable cells.

Another popular dietary adjunct that may be added to frozen desserts is *L. acidophilus*. Certain strains of this bacterium were reported to assimilate cholesterol in a laboratory medium (Gilliland et al., 1984) as well as to lower serum cholesterol in rats (Grunewald, 1982). It is important that bacteria added to foods

for probiotic effects be able to survive the effects of low pH and bile and to attach to and grow in a niche of the intestinal tract.

Each of the lactose-fermenting bacteria is a potential carrier of β -galactosidase. If these bacteria survive through the stomach and resist lysis by bile acids and enzymes, they may be permeated by lactose molecules. Intercellular β -galactosidase can then hydrolyze lactose to glucose and galactose so it can be absorbed through the human intestinal cell wall. Thus, symptoms of lactose malabsorption, a common malady among persons of Asian and African descent, can be reduced or eliminated.

VI. SHERBETS, SORBETS, AND ICES

Whereas sherbets contain 2–5% total milk solids, neither sorbets nor ices contain milk solids. All three product groups are high in sweetener; contain fruits, fruit juices, or fruit flavoring; and are generally acidic. Sherbet mix of typical composition can be made by adding one part of ice cream mix to four parts of water ice mix. Because sherbet contains milk solids, it must be pasteurized. A product called yogurt sherbet is defined in the California Food and Agricultural Code as having an acidity of 0.6% calculated as lactic acid and a yogurt content of not less than 40%.

Water ices typically contain 20–30% sugar, 0.35–0.5% citric acid, fruit flavoring, gum stabilizer, and water. Sorbet is a frozen fruit product that can be considered to be an “upscale” version of Italian ice (water ice). White tablecloth restaurants often serve it as an intermezzo between the appetizer and the main course. There is no federal standard for the product. It usually contains 30–50% fruit or fruit juice, 30% sugar, 2.6% egg white solids and pectin, modified cellulose, and/or gum stabilizer. At least one company has produced a chocolate sorbet. Overrun is 20% or less. Because it is expected to contain no milk ingredient, persons who suffer allergies to components of milk consider it to be safe to eat. However, since it is usually made in equipment used also to make ice cream, there is a risk that traces of milk proteins may enter a sorbet. This happened in Rochester, MN, when a 3-year old boy consumed 4–6 oz of lemon sorbet (Laoprasert et al., 1998). The quantity of protein ingested was only 120–180 μ g, but symptoms of itching throat, facial angioderma, and vomiting were experienced within 20 min of consumption.

Water ices and sorbets may not be required to be pasteurized. Their very low pH restricts growth of microorganisms to yeasts and molds. Furthermore, mixes are commonly prepared immediately before freezing, thus limiting the potential for microbial growth. They remain susceptible to contamination from ingredients, equipment, personnel, and the environment. Acid-tolerant

bacteria, especially spores, can survive in them but will have little opportunity to grow.

VII. FROZEN NOVELTIES

In the United States, frozen novelties consist of frozen ices (26%), ice cream sandwiches (16%), ice cream bars (12%), fruit or juice bars (10%), fudge bars (9%), ice cream cones (9%), and numerous other forms of single-serve frozen items. They differ from related products in multiserve containers primarily in the ways they are frozen, formed, and packaged. Some, particularly frozen ices, are frozen quiescently in refrigerated molds. Their maximum expansion in volume (overrun) is 10%. Others, especially ice cream bars on sticks, are first soft-frozen with air incorporated and then hardened in molds or are extruded in very stiffly frozen form onto conveyors that carry them through hardening tunnels. Ice cream may be extruded into the space between two cookies to form ice cream sandwiches. Many of the ice cream and frozen yogurt bars on-a-stick are dipped in chocolate or fruit-flavored coatings.

With novelty items the main microbiological considerations relate to cleanliness of equipment with which the novelties are formed or packaged. The typical plant runs continuously for many hours, and molds of the forming equipment are subjected to alternate cold and warm temperatures. Although there is little opportunity for microbial growth, contaminants from the environment are not likely to be killed during operation. This makes it important to maintain a high degree of sanitation within the area of freezing, forming, and packaging of novelties. It is highly important that airborne contaminants not be produced from dust or mists wherever novelties are exposed to open air (not enclosed by equipment or packages). Dry floor operations are recommended to avoid splash and creation of aerosols. Goff and Slade (1990) used a pilot scale wind tunnel, operated at -16 to -18°C , to demonstrate that *L. monocytogenes* could be transferred to frozen unpackaged ice cream via contaminated cold air.

VIII. PROCESSING MIXES

The most important process in any dairy plant is pasteurization, because safety of the product depends on successful performance of this lethal heat treatment. Standards set for time and temperature of heating ice cream mixes (Table 1) are adequate to kill vegetative forms of pathogenic microorganisms that may be found in frozen dessert mixes. Residual spores of pathogenic bacteria are not

Table 1 Minimal Times and Temperatures Required for Pasteurization of Frozen Dessert Mixes

Method	Temperature, °C (°F)	Time
LTLT	69 (155)	30 min
HTST	80 (175)	25 s
	83 (180)	15 s

LTLT, low temperature, long time, or batch (vat) method; HTST, high temperature, short time, or continuous method.

considered to be dangerous, because they are unable to germinate and grow under conditions of storage of either the mix or frozen product.

Pathogens introduced into ice cream mixes by ingredients, equipment, personnel, or the environment are killed by pasteurization, but recontamination may occur in subsequent operations. The potential for amplification of the effects of pathogens increases as sizes of dairy processing facilities increase. This is true because large plants serve large numbers of consumers over a wide trade territory.

Controls are provided on continuous pasteurizers to ensure that minimal temperatures are maintained until mix reaches the end of the holding tube. Also, pasteurizers are required to be designed and operated to provide minimal times of holding mixes at the minimal temperature. However, research by Goff and Davidson (1992) revealed that mix viscosity is a major variable that can affect time of holding a mix in a pasteurizer. They found that laminar flow characteristics are likely to exist in holding tubes of high-temperature, short time (HTST) pasteurizers when ingredients cause viscosities to become unusually high. Generalized Reynolds numbers, which are measures of turbulence in flowing liquids, ranged from 100 to 1700 in holding tubes of sizes common to the dairy industry. Laminar flow is likely to exist when Reynolds numbers are less than 2100 (Denn, 1980). In true laminar flow, mix that is at the tube wall flows one-half as fast as that in the center of the tube, whereas, in true turbulent flow, mixing is so thorough that particles travel at the same average rate in any cross section of the pipe. Because of the high potential for laminar flow of ice cream mixes in pasteurizer holding tubes, special considerations should be given to their design.

The method approved in 3A Sanitary Standard No. 603-06 (3A Sanitary Standards Committee, 1992) provides that, for most pasteurizers, the pumping rate is experimentally determined by timing the filling of a can of known volume and referencing this to a table of tube diameters and holding times of 15 and 25 s. Furthermore, holding time is confirmed by pumping water through the tube

and detecting the time taken for an injected salt solution to pass conductivity sensors at each end of the holding tube. Whereas this method of testing provides reliable times for passage of products with the viscosity of milk, it is unlikely to be satisfactory for ice cream mixes that vary widely in viscosity. To overcome this problem, one approach is to design holding tubes to provide twice the holding time that would be applicable during turbulent flow. The 3A accepted practices provide that fully developed laminar flow is assumed when the desired holding tube length is calculated. This may result in more heated flavor than is desirable in the product. An alternative approach is to design pasteurizers with characteristics that ensure turbulent flow.

IX. FREEZING AND FROZEN STORAGE

In the freezing of ice cream, cold mix is admitted to a freezing chamber and subjected to whipping in the presence of air while the ice crystals that form on the wall of the freezing cylinder are scraped from the wall. Temperature drops rapidly and ice forms quickly in continuous freezers, but the process takes several minutes in batch freezers. These conditions place severe stresses on microorganisms in the mix. Factors that affect survival of microorganisms during freezing and frozen storage include the type and physiological condition of the cells, composition of the food, treatment of the food before freezing, rate and method of freezing, and the temperature, time, and conditions of storage. Ice crystals that form outside the cells reduce the amount of free water in which solute can be dissolved. Those that form inside cells have the potential to puncture cell membranes. Mazur (1966) concluded that viabilities of microorganisms subjected to subzero temperatures are affected primarily by solute concentration and intracellular freezing. Water that freezes in the cell is free water, and this water forms ice crystals. Bound water remains unfrozen. As crystals form, the cytoplasm becomes more concentrated and viscous. Electrolytes and acids are concentrated. Colloidal constituents may be precipitated and proteins denatured. Intracellular ice is thought to be more harmful to microorganisms than extracellular ice. However, Ray and Speck (1973) concluded that, during freezing, formation of extracellular ice was the principal cause of bacterial death and that cells in the stationary phase of growth resist freezing better than those in the logarithmic phase.

The result is that many microorganisms die. Generally, gram-negative rods and the vegetative cells of yeasts and molds are more easily killed than gram-positive bacteria, and bacterial and fungal spores are largely unaffected by subzero temperatures (Georgala and Hurst, 1963). Encapsulated bacteria survive freezing better than do the same strains that have lost the ability to express capsules because of mutations. The number of strains of encapsulated yogurt bacteria is limited, and it is important that yogurt bacteria survive freezing so they can

deliver β -galactosidase to the human intestine of persons who are deficient in that enzyme and cannot, therefore, digest amounts of lactose they may ingest. During frozen storage at -20°C , the rate of death of yogurt bacteria in frozen yogurt was observed to be quite low. Ingram (1951) summarized the following effects of freezing on selected microorganisms: (a) many species experience an abrupt loss in viability on freezing and (b) cells left viable after freezing die slowly during frozen storage, with the death rate being highest when temperature approaches the melting point of the food and lowest at -20°C and below.

X. SERVING FROZEN DESSERTS

All of the care in selecting and protecting ingredients, in cleaning and sanitizing equipment, in pasteurizing in a properly constructed and operated heat exchanger, and in packaging ice cream aseptically in containers that are practically sterile can be for naught if the product is contaminated with pathogens during serving.

Gould et al. (1948), in a survey of ice cream stores, found 11 of 20 hand-packed samples had coliform counts of more than 10/g, whereas only 2 of 14 factory-packed samples from the same stores had this high number of coliforms. Ice cream scoops and dippers as well as the hands of the store workers are likely sources of contaminants in dipped ice cream. Water should be kept flowing in dipper wells to ensure that bacterial growth is prevented in water used to warm and cleanse dippers and scoops.

Persons who are ill or infected should not dispense frozen desserts. All workers should wear clean clothing and hair restraints and should wash their hands before working in dispensing operations and every time there is a chance of their hands becoming contaminated.

XI. REGULATORY CONTROLS AND INDUSTRY STANDARDS

There is no federal standard for counts of bacteria in frozen desserts in the United States. However, most states enforce standards for coliform bacteria at less than or equal to 10/g and for standard plate count at 50,000/g. One state enforces a maximum standard plate count of 20,000/g. Approximately 14 states permit coliform counts of up to 20/g for bulky flavored ice creams. These are products to which large amounts of flavorings, fruits, and nuts are added. Because many of these items are added after freezing, the chances of contamination with coliform bacteria is considerably greater than with plain ice creams. With the recent knowledge that microbial environmental contaminants include *Listeria*, it is prudent for manufacturers to consider the presence of coliform bacteria in ice cream as

indicative of unsanitary practices and to increase the intensity of hygienic activities when coliform bacteria are found in finished products.

Coliform bacteria belong to the larger group of gram-negative asporogenous facultatively anaerobic glucose-fermenting bacteria of the family Enterobacteriaceae, all of which are killed by pasteurization of ice cream mixes. Testing for this group of bacteria, rather than for the coliform group only, increases the sensitivity of the test for postpasteurization contamination. The modification of the coliform test is simple: instead of lactose, 1% glucose is added to the Violet Red Bile Agar used to plate the sample. Appearance of typical colonies arising from plating of 1 g of sample is indicative of postpasteurization contamination and the possible entrance of pathogenic bacteria into the product. Therefore, the cause of the problem should be determined and corrected.

The FDA has tested finished ice cream products for pathogens, principally *L. monocytogenes*, and numerous recalls have ensued when samples have been positive (Anonymous, 1986a, 1986b, 1986c, 1986d, 1994). The U.S. Code of Federal Regulations, Title 21, Part 7.40 (21 CFR 7.40) provides recall policies, procedures, and industry responsibilities.

Recall is a voluntary act of manufacturers and distributors who seek to protect the health and welfare of consumers from products that may present a risk of injury or gross deception or are otherwise defective. Recall is an alternative to FDA-initiated court action to remove violative, distributed products. Recalls are assigned classes I, II, or III depending on the relative degree of health hazard with the greatest risk associated with class I recalls. The FDA may request a recall when a distributed product presents a risk of illness and the manufacturer or distributor has not initiated a recall. A recalling firm is expected to conduct checks of the effectiveness of the recall action.

A survey of 530 samples of ice cream mix (85), ice cream (394), and ice cream novelties (51) by Health and Welfare Canada revealed only two samples that contained *L. monocytogenes* (Farber et al., 1989). Furthermore, the WHO Working Group (1988) reported the incidence of *L. monocytogenes* in ice cream as varying from 0 to 5.5% with very low numbers (1–15 cfu/g) usually being observed.

The heat resistance of *L. monocytogenes* is higher than that of many vegetative bacteria (Doyle et al., 1987). Its heat resistance can be enhanced in milk and cream in which it is contained in white blood cells (leukocytes). As an agent of bovine mastitis (Gitter et al., 1980), *L. monocytogenes* is phagocytized by leukocytes of the mammary gland. If numbers of phagocytized *L. monocytogenes* are sufficiently high, the pathogen may survive minimal conditions of high-temperature, short-time pasteurization of milk (Garayzabel et al., 1985; Doyle et al., 1987). However, the incidence of mastitis caused by *L. monocytogenes* is quite low. Furthermore, leukocytes and, consequently, phagocytized bacteria are mostly removed by clarification and separation during the preparation of cream

for the manufacture of ice cream. No evidence has been forthcoming that these bacteria survive pasteurization of ice cream mix.

L. monocytogenes appears to survive well the freezing and frozen storage of ice cream (Golden et al., 1988; Palumbo and Williams, 1991; Dean and Zottola, 1996). Dean and Zottola (1996) inoculated ice cream mixes with an 18-h-old culture of *L. monocytogenes* V7, froze the mix to -5 to -6°C , and stored samples at -18°C for up to 3 months. One set of mixes contained 14 mg/L (535 IU/g) of the bacteriocin nisin (Nisaplin) and another set contained no nisin. Counts of *L. monocytogenes* decreased insignificantly in samples without nisin; however, counts decreased to near zero in the samples that contained nisin. Nisin was slightly less effective in ice cream containing 10% milkfat than in samples containing 3% milkfat. Jung et al. (1992) observed lowered nisin activities in high-fat-containing milk products.

L. monocytogenes is a gram-positive, non-spore-forming short rod that is motile with peritrichous flagella. This ubiquitous psychrotroph (Donnelly and Briggs, 1986; Rosenow and Marth, 1987) is pathogenic to humans and animals. Most persons who have contracted listeriosis have been pregnant women, neonates, or immunocompromised adults (Gray and Killinger, 1966; Seeliger, 1986).

An outbreak of gastrointestinal infections caused by *S. Enteritidis* in ice cream was observed beginning in September 1994. After a case-control study implicated a national brand of ice cream, much of the product was recalled by the manufacturer. Gastroenteritis developed in an estimated 224,000 persons (Hennessey et al., 1996), but fewer than 600 cases were reported to public health departments (Anonymous, 1996). The attack rate was estimated at 6.6% among consumers of the affected products. *Salmonella* was isolated from 8 of 266 ice cream products (3%) but not from environmental samples. The source of the pathogens was believed to be transport trucks used to haul both nonpasteurized liquid eggs and pasteurized ice cream mix. The mix was not repasteurized at the plant to which it was delivered in the tank trucks for freezing. The lesson learned was that repasteurization should be done when a mix is given any opportunity to be contaminated after pasteurization and especially when it is moved from one location to another in reusable containers. Such reusable containers should be dedicated to transport of mix only.

XII. MICROBIOLOGICAL METHODS

Tests for microbiological quality and safety of frozen desserts and their ingredients are described in *Standard Methods for the Examination of Dairy Products* (Marshall, 1993), the *Compendium of Methods for the Microbiological Examination of Foods* (Vanderzant and Splittstoesser, 1992), and the *Official Methods of Analysis* (Cuniff, 1999). Tests most relied on to reflect overall microbiological

quality have been the standard plate count (aerobic plate count) and the coliform count. Petrifilm (3M Health Care, St. Paul, MN) methods of performing each of these counts are given official status in standard methods and can be substituted for the plating methods. Furthermore, the spiral plating method for determination of the total aerobic plate count is an officially recognized method in standard methods.

Methods for enumeration of microorganisms are classified in *Standard Methods for the Examination of Dairy Products* (SMEDP) and in the official methods manual of AOAC International. Classification is based on three criteria: (a) research that thoroughly evaluates the method, (b) collaborative testing in qualified laboratories, and (c) demonstration of applicability based on extensive use. The AOAC decides whether these qualifications have been met and awards a method first action status when it has been thoroughly evaluated and collaboratively tested; final action status is assigned when those methods have been proven in extensive use. The SMEDP classification terminology for these methods is A2 and A1, respectively. Recently, two additional classifications have been added. Class A3 applies to methods approved after meeting criteria set by the United States Conference on Interstate Milk Shipments for milk produced and shipped under provisions of the U.S. Pasteurized Milk Ordinance. Class A4 applies to methods granted Performance Tested status after evaluation by AOAC International Research Institute (Wehr, 2001).

As given in *Standard Methods for the Examination of Dairy Products* (Marshall, 1993), the agar method for enumerating coliform bacteria in ice cream products calls for making a 1:2 or 1:10 dilution and distributing 10 mL of this dilution equally into three Petri dishes to which is added Violet Red Bile Lactose Agar. Matushek et al. (1992) showed that dilution of ice cream produced more accurate results than did direct plating. The major reason for inaccuracies with the direct plating method was atypical colonies produced with the directly plated samples. Non-lactose-fermenting bacteria can ferment sugar contained in plating media to which ice cream or frozen desserts are added, producing false-positive tests. The lower the dilution of the sample, the greater the concentration of sugar in the medium and the greater the chance for false-positive results (red colonies arise when acid is produced from fermentable sugar in the medium). Confirmation of suspect colonies as coliforms can be done by incubation in brilliant green bile lactose broth in which coliform bacteria produce gas when incubated at 32°C. False-negative results can occur when ingredients of frozen desserts inhibit growth. Inaccuracies may occur when excess product on a plate causes overcrowding (more than approximately 150 colonies), resulting in colonies that are less than 0.5 mm in diameter. Finally, pipeting undiluted sample cannot be done with precision because of the high and variable viscosities of frozen dessert mixes.

The official procedure (Marshall, 1993) for enumerating coliform bacteria with the Petrifilm method calls for making a 2:3 dilution of ice cream and plating

0.5 mL of this dilution onto one or each of three prehydrated coliform count plates. Experiments by Matushek et al. (1992) demonstrated that the Petrifilm coliform count method was highly satisfactory with higher confirmation rates (94–100%) than any of the other methods tested.

Freezing of desserts produces dead, injured, and fully viable cells. Many factors interact to determine the fate of microorganisms on freezing. The common practice used to differentiate injured from uninjured cells is to plate a sample on an inhibitory medium such as Violet Red Bile Agar (VRBA) (used to enumerate coliform bacteria) as well as a productive but nonselective medium such as Tryptic Soy Agar. The injured cells among the survivors of freezing will grow on the nonselective medium but not on the selective agar, whereas noninjured cells will grow on both. This principle has been used in the Modified VRBA procedure of SMEDP in which the sample is plated in 10 mL of Tryptic Soy Agar (TSA). After solidification, the base medium is overlaid with an equal amount of double-strength VRB agar. The remainder of the test is unchanged from the VRBA procedure. The bile salts, neutral red, and crystal violet in the double-strength VRB agar diffuse into the TSA providing the needed inhibition of noncoliform bacteria.

Testing of 353 environmental samples taken at four ice cream and six liquid milk plants by Cotton and White (1990) failed to show a relationship between standard plate count, coliform count, or psychrotrophic bacteria count and the presence of *L. monocytogenes*, but high counts by these methods were associated with the presence of *Yersinia enterocolitica* ($P < .01$).

New tests for small numbers of pathogens in frozen desserts are being made possible by technological developments. For example, *E. coli* 0157:H7 was recovered and identified within 10 h at concentrations as low as 1 cfu/g of ice cream (Gooding and Choudary, 1997). Samples were enriched in Tryptic Soy Broth for 4 h, captured by immunomagnetic separation, amplified by polymerase chain reaction of parts of the verotoxin genes (SLT-I and SLT-II), and detected by agarose gel electrophoresis.

XIII. SUMMARY

Ice cream and other frozen desserts are protected from spoilage by very low temperatures of preparation and storage; however, major ingredients used to make these products are prone to spoilage and several ingredients are added after the last lethal process, pasteurization, has been completed. Therefore, microorganisms are of considerable importance to the frozen desserts industry. Pathogens of greatest importance are *L. monocytogenes* and *S. Enteritidis*. The most threatening spoilage bacteria are psychrotrophs in the refrigerated dairy products and yeasts and molds in fruits and nuts. Dry ingredients and flavoring and colors are likely to contribute bacterial spores, but they seldom are of concern because of

their low numbers and their inability to germinate and grow in the frozen products.

Ice cream is a relatively safe product, but failure to pasteurize it and to prevent environmental contamination can render it unsafe, especially to infants and immunocompromised adults.

REFERENCES

- Anonymous. Food Chem News 28(19):31, 1986a.
- Anonymous. Food Chem News 28(24):11, 1986b.
- Anonymous. Food Chem News 28(27):17, 1986c.
- Anonymous. Food Chem News 28(35):25, 1986d.
- Anonymous. Food Chem News 36(33):34, 1994.
- Anonymous. How safe is our food? Lessons from an outbreak of salmonellosis (editorial). N Engl J Med 334:1324, 1996.
- Anonymous. Food Safety. In: Eggyclopedia. Park Ridge, IL: American Egg Board, 1999, Chap. 3.
- Beuchat LR. *Escherichia coli* on pecans: survival under various storage conditions and disinfection with propylene oxide. J Food Sci 38:1036, 1973.
- Beuchat LR. Relationship of water activity to moisture content in tree nuts. J Food Sci 43:754, 1978.
- Bezkorovainy A, Grohlich D, Nichols JH. Isolation of a glycopolypeptide fraction with *Lactobacillus bifidus* subspecies *pennsylvanicus* growth-promoting activity from human milk casein. Am J Clin Nutr 32:1428, 1979.
- Board RG, Tranter HS. The microbiology of eggs. In: Stadelman WJ, Cotterill OJ, eds. Egg Science and Technology. 4th ed. Binghamton, NY: Haworth, 1995.
- Broadbent JR, Lin C. Effect of heat shock or cold shock treatment on the resistance of *Lactococcus lactis* to freezing and lyophilization. Western Dairy Center, Logan, UT. Academic Press, 1999.
- Brooks J, Taylor DI. Eggs and egg products. G. B. Dep Sci Ind Res Board, Spec Rep Food Invest. 60, 1955.
- Chignell CF, Starkweather DK, Sinha BK. A spin label study of egg white avidin. J Biol Chem 250:5622, 1975.
- Christen GL, Marshall RT. Effect of histidine on thermostability of lipase and protease of *Pseudomonas fluorescens* 27. J Dairy Sci 68:594, 1985.
- Clagett CO. Genetic control of the riboflavin carrier protein. Fed Proc Fed Am Soc Exp Biol 30:127, 1971.
- Cotterill OJ, Glauert J. Destruction of *Salmonella oranienburg* in egg yolk fractions; emulsion stabilizing power, viscosity and electrophoretic patterns. Poult Sci 48:251, 1972.
- Cotton LN, White CH. Predictive tests for the presence of environmental pathogens. J Dairy Sci 73:(Suppl 1):260, 1990.
- Cunniff PA ed. Official Methods of Analysis. Gaithersburg, MD: AOAC International, 1996.

- Dean JP, Zottola EA. Use of nisin in ice cream and effect on survival of *Listeria monocytogenes*. J Food Prot 59:476, 1996.
- Denn MM. Process Fluid Mechanics. Englewood Cliffs, NJ: Prentice-Hall, 1980.
- De Tamsut LS, Garcia CE. Microbiological quality of vanilla ice cream manufactured in Caracas, Venezuela. Arch Latinoam Nutr 39:46, 1989.
- Donnelly CW, Briggs EH. Psychrotrophic growth and thermal inactivation of *Listeria monocytogenes* as a function of milk composition. J Food Prot 49:994, 1996.
- Doyle MP, Glass KA, Beery GT, Garcia GA, Pollard DJ, Schultz RD. Survival of *Listeria monocytogenes* in milk during high temperature short-time pasteurization. Appl Environ Microbiol 53:1433, 1987.
- Farber JM, Sanders GW, Johnston MA. A survey of various foods for the presence of *Listeria* species. J Food Prot 52:456, 1989.
- Feller G, Gerday C. Psychrophilic enzymes: molecular basis of cold adaptation. Cell Mol Life Sci 53:830, 1997.
- Fox CW, Chrisope GL, Marshall RT. Incidence and identification of phospholipase C-producing bacteria in fresh and spoiled raw milk. J Dairy Sci 59:2024, 1976.
- Froning G, Izat A, Riley G, Magwire H. Eggs and egg products. In: Vanderzant C, Splitstoeser DF, eds. Compendium of Methods for the Microbiological Examination of Foods. 3rd ed. Washington, DC: American Public Health Association, 1992.
- Garayzabel JFF, Rodrigues LD, Boland JAV, Canulo JLB, Fernandez GS. *Listeria monocytogenes* dans le lait pasteurisé. Can J Microbiol 32:149, 1985.
- Georgala DL, Hurst A. The survival of food poisoning bacteria in frozen foods. J Appl Bacteriol 26:346, 1963.
- Gerday C, Aittaleb M, Arpigny JL, Baise E, Chessa JP, Garsoux G, Petrescu G, Petrescu I, Feller G. Psychrophilic enzymes: a thermodynamic challenge. Biochim Biophys Acta 1342:119, 1997.
- Gilliland SE, Nelson CR, Maxwell C. Assimilation of cholesterol by *Lactobacillus acidophilus*. Appl Environ Microbiol 49:377, 1985.
- Gitter M, Bradley R, Blampied PH. *Listeria monocytogenes* infection in bovine mastitis. Vet Rec 107:390, 1980.
- Goff HD, Davidson VJ. Flow characteristics and holding time calculations of ice cream mixes in HTST holding tubes. J Food Prot 55:34, 1992.
- Goff HD, Slade PJ. Transmission of *Listeria* sp. through a cold air tunnel. Dairy Food Environ Sanit 10:340, 1990.
- Gooding CM, Choudary PV. Rapid and sensitive immunomagnetic separation-polymerase chain reaction method for the detection of *Escherichia coli* 0157:H7 in raw milk and ice cream. J Dairy Res 64:87, 1997.
- Gould IA, Larsen PB, Doetsch RN, Potter FE. Maintaining quality in ice cream. Ice Cream Field 52:80, 1948.
- Gray ML. Epidemiological aspects of listeriosis. Am J Public Health 35:554, 1963.
- Gray ML, Killinger AH. *Listeria monocytogenes* and listeric infections. Bacteriol Rev 30:309, 1966.
- Grunewald KK. Serum cholesterol levels in rats fed skim milk fermented by *L. acidophilus*. J Food Sci 47:2078, 1982.
- Gyorgy P, Jeanloz RW, von Nicolai H, Zilliken F. Undialyzable growth factors for *Lactobacillus bifidus* var *pennsylvanicus*. Eur J Biochem 43:29, 1974.

- Hagen M, Narvhus JA. Production of ice cream containing probiotic bacteria. *Milchwissenschaft* 54:265, 1999.
- Hekmut S, McMahon DJ. Survival of *Lactobacillus acidophilus* and *Bifidobacterium bifidum* in ice cream for use as a probiotic food. *J Dairy Sci* 75:1415, 1992.
- Hennessy TW, Hedberg CW, Slutsker L, White KE, Besser-Wiek JM, Moen ME, Feldman J, Coleman WW, Edmondson LM, MacDonald KL, Osterholm MT, Investigation Team. A national outbreak of *Salmonella enteritidis* infections from ice cream. *N Engl J Med* 334:1281, 1996.
- Hong SH. Enhancing survival of lactic acid bacteria in ice cream by natural encapsulation and gene transfer. PhD dissertation, University of Missouri, Columbia, MO, 1995.
- Ingram M. The effect of cold on microorganisms in relation to food. *Proc Soc Appl Bacteriol* 14:243, 1951.
- Jao YC, Mikolajcik EM, Hansen PMT. Growth of *Bifidobacterium bifidum* var *pennsylvanicus* in laboratory media supplemented with sugars and spent broth from *Escherichia coli*. *J. Food Sci* 43:1257, 1978.
- Jeffreys AG, Hak KM, Steffan RJ, Foster JW, Bej AK. Growth, survival and characterization of *cspA* in *Salmonella enteritidis* following cold shock. *Curr Microbiol* 36:39, 1998.
- Jung DS, Bodyfelt FW, Daeschel MA. Influence of fat and emulsifiers on the efficacy of nisin in inhibiting *Listeria monocytogenes* in fluid milk. *J Dairy Sci* 75:387, 1992.
- King AD Jr, Miller MJ, Eldridge LC. Almond harvesting, processing and microbial flora. *Appl Microbiol* 20:208, 1970.
- King AD Jr, Shade JE. Influence of almond harvesting, processing and storage on fungal population and flora. *J Food Sci* 51:202, 1986.
- Klausner RB, Donnelly CW. Environmental sources of *Listeria* and *Yersinia* in Vermont dairy plants. *J Food Prot* 54:607, 1991.
- Kocak C, Akan M, Yardimci H. Bacteriological quality of ice cream marketed in Ankara. *Veteriner-Fakultesi-Dergisi*, Ankara University 45:1, 131, 1998.
- Kozak J, Balmer T, Byrne R, Fisher K. Prevalence of *Listeria monocytogenes* in Foods: "Incidence in Dairy Products." International Dairy Foods Association, Washington, DC. Presented at the International Food Safety Conference, *Listeria*, The State of the Science, Rome, Italy, June 29–30, 1995.
- Laoprasert N, Wallen ND, Jones RT, Hefe SL, Taylor SL, Yunginger JW. Anaphylaxis in a milk-allergic child following ingestion of lemon sorbet containing trace quantities of milk. *J Food Prot* 61:1522, 1998.
- Lock JL, Dolman J, Board RG. Observations on the mode of bacterial infection of hen's eggs. *FEMS Microbiol Lett* 100:701, 1992.
- Lopez MC, Medina LM, Jordano R. Survival of lactic acid bacteria in frozen yogurt. *J Food Sci* 63:706, 1997.
- Lorca GL. Temperature adaptation and cryotolerance in *Lactobacillus acidophilus*. *Biotechnol Lett* 20:847, 1998.
- Luyet B. Recent developments in cryobiology and their significance in the study of freezing and freeze-drying of bacteria. In: *Proceedings Low Temperature Microbiology*. Camden, NJ: Campbell Soup Co., 1962, p 63.
- Marin A, Marshall RT. Production of glycosidases by psychrotrophic bacteria. *J Food Sci* 48:570, 1983.

- Marshall RT, ed. Standard Methods for the Examination of Dairy Products. 16th ed. Washington, DC: American Public Health Association, 1993.
- Marshall RT, Marsteller J. Unique response to heat of extracellular protease of *Pseudomonas fluorescens* M5. J Dairy Sci 64:1545, 1983.
- Mastronicolis SK. Influence of cold shock on the fatty acid composition of different lipid classes of the food-borne pathogen *Listeria monocytogenes*. Food Microbiol 15: 299, 1998.
- Masud T. Microbiological quality and public health significance of ice cream. J Pak Med Assoc 39:102, 1989.
- Matushek MG, Curiale MS, McAllister JS, Fox TL. Comparison of various plating procedures for the detection and enumeration of coliforms in ice cream and ice milk. J Food Prot 55:113, 1992.
- Mazur P. Physical and chemical basis of injury in single-celled microorganisms subjected to freezing and thawing. In: Meryman HT, ed. Cryobiology. New York: Academic Press, 1966.
- Mayerhofer HJ, Marshall RT, White CH, Lu M. Characterization of a heat-stable protease of *Pseudomonas fluorescens* P26. Appl Microbiol 25:44, 1973.
- Metchnikoff E. The Prolongation of Life. New York: GP Putnam and Sons, 1908.
- Miettinen MK, Bjorkroth KJ, Korkeala HJ. Characterization of *Listeria monocytogenes* from an ice cream plant by pulsed-field gel electrophoresis. Int J Food Microbiol 46:187, 1999.
- Modler HW, McKellar RC, Goff HD, Mackie DA. Using ice cream as a mechanism to incorporate bifidobacteria and fructooligosaccharides into the human diet. Cultured Dairy Prod J 25(3):4, 1990.
- Morris GK. *Salmonella enteritidis* and eggs: Assessment of risk. Poultry Sci (Suppl 1): 1000, 1989.
- National Soft Drink Association. Quality Specifications and Test Procedures for Bottlers' Granulated and Liquid Sugar. Washington, DC: National Soft Drink Association, 1975.
- Nichols G, de Louvois J. The microbiological quality of ice cream and other edible ices. PHLs Microbiol Dig 12:11, 1995.
- Obata H, Ishigaki H, Kawahara H, Yamade K. Purification of a novel cold-regulated protein from an ice-nucleating bacterium, *Pseudomonas fluorescens* KUIN. Biosci Biotechnol Biochem 62:2091, 1998.
- Poch M, Bezkorovainy A. Bovine milk k-casein digest is a growth enhancer for the genus *Bifidobacterium*. J Dairy Sci 71:3214, 1991.
- Ravula RR, Shah NP. Viability of probiotic bacteria in fermented frozen dairy desserts. Food Australia 50:3, 1998.
- Ray B, Speck ML. Freeze injury in bacteria. In: King JK, Faulkner WR eds. Critical Reviews in Clinical Laboratory Science. Cleveland, OH: CRC Press, 1973, p 161.
- Robinson DK. Yogurt manufacture—some considerations of quality. Dairy Indus Int 46: 31, 1981.
- Rosenow EM, Marth EH. Growth of *Listeria monocytogenes* in skim, whole and chocolate milk, and in whipping cream during incubation at 4, 8, 13, 21, and 35°C. J Food Prot 50:452, 1987.
- Ryser ET, Marth EH. *Listeria*, Listeriosis and Food Safety. New York: Marcel Dekker, 1991.

- Schmidt KA, Kim J, Jeon JJ. Composition and concentration of beta-galactosidase of commercial frozen yogurt. *J Food Qual* 20:349, 1997.
- Seeliger HPR. Diagnosis and treatment of listeriosis. In: *Listeriosis*. Joint WHO/ROI Consultation on Prevention and Control. Berlin, December 10–12, 1986.
- Shafi R, Cotterill OJ, Nichols ML. Microbial flora of commercially pasteurized egg products. *Poultry Sci* 49:578, 1970.
- Shahani KM, Vakil JR, Kilara A. Natural antibiotic activity of *Lactobacillus acidophilus* and *bulgaricus*. II. Isolation of acidophilin from *L. acidophilus*. *Cult Dairy Prod J* 12(12):8, 1977.
- Sheu J-S, Marshall RT. Improving survival of culture bacteria in frozen desserts by microentrapment. *J Dairy Sci* 76:1902, 1993.
- Speck ML, Tarver FR. Microbiological populations in blended eggs before and after commercial pasteurization. *Poultry Sci* 46:1321, 1967.
- 3A Sanitary Standards Committee. 3A Accepted Practices for the Sanitary Construction, Installation, Testing and Operation of High-temperature Short-time and Higher-heat Short-time Pasteurizer Systems. Revised, Number 603-06. McLean, VA: 3A Sanitary Standards Committee, 1992.
- Troller JA. Food spoilage by microorganisms tolerating low a_w environments. *Food Technol* 33:72, 1979.
- U.S. Food and Drug Administration. FDA dairy product safety initiatives. Second year status report. Washington, DC: Milk Safety Branch, Center for Food Safety and Applied Nutrition, 1987.
- USHEW. Propylene oxide. 21 CFR 193.380. Public Health Service, Food and Drug Administration. Washington, DC: U.S. Department of Health, Education, and Welfare, 1978.
- Vanderzant C, Splittstoesser DF, eds. *Compendium of Methods for the Microbiological Examination of Foods*. 3rd ed. Washington, DC: American Public Health Association, 1992.
- Walker HW, Ayers JC. Yeasts as spoilage organisms. In: Rose AH, Harrison JS, eds. *The Yeasts*. Vol 3. *Yeast Technology*. New York: Academic Press, 1970.
- Walker RL, Jensen LH, Kinde H, Alexander AV, Owens LS. Environmental survey for *Listeria* species in frozen milk product plants in California. *J Food Prot* 54:178, 1991.
- Wehr, HM, ed. *Standard Methods for the Examination of Dairy Products*. 17th ed. Washington, DC: American Public Health Association, 2001.
- Whistler RL, Paschall EF. *Starch: Chemistry and Technology*. Vol II. New York: Academic Press, 1967.
- WHO Working Group. Foodborne listeriosis. *Bulletin of the WHO* 66(4):421, 1988.
- Winter AR, Wilkin M. Holding, freezing and storage of liquid egg products to control bacteria. *Food Freezing* 2(4):338, 1947.
- Wouters JA, Rombouts FM, de Vos WM, Kuipers OP, Abee T. Cold shock proteins and low-temperature response of *Streptococcus thermophilus* CNRZ302. *Appl Environ Microbiol* 65:4436, 1999.
- Wrinkle C, Weiser HH, Winter AR. Bacterial flora of frozen egg products. *Food Res* 15: 91, 1950.
- Zilliken F, Rose CS, Braun GA, Gyorgy P. Preparation of alkyl *N*-acetyl- α - and β -*D*-glucosaminides and their microbiological activity for *Lactobacillus bifidus* var. *penn*. *Arch Biochem* 54:392, 1955.

5

Microbiology of Butter and Related Products

Jeffrey L. Kornacki* and Russell S. Flowers

*Silliker Laboratories Group, Inc.
Homewood, Illinois*

Robert L. Bradley, Jr.

*University of Wisconsin–Madison
Madison, Wisconsin*

I. INTRODUCTION AND DEFINITIONS

A. Volumes of Butter and Brief History

Worldwide consumption of butter and milkfat products is estimated at 2,420,000 tons in 1993 for countries where data are available (Table 1). In 1998, the United States produced 1082×10^6 lb of butter with none being purchased by the government as surplus (IDFA, 1999). Butter was one of the first dairy products manufactured by humans and has been traded internationally since the 14th century (Anderson, 1986; Varnam and Sutherland, 1994). All butter manufacture relies on cream as a starting material. From ancient times through the latter part of the 1800s, cream was obtained from milk by gravity separation. In the 1850s, creameries began producing butter on a small scale. Large-scale manufacture only became possible after development of the mechanical cream separator in 1877 (Varnam and Sutherland, 1994).

B. Composition and Types of Butter

Butter is a water-in-oil emulsion, wherein milkfat forms the continuous phase. This is in contrast to cream, which is an emulsion of milkfat globules suspended in an aqueous phase. Thus, an emulsion phase inversion occurs during manufac-

**Present affiliation:* Center for Food Safety, The University of Georgia, Griffin, Georgia.

Table 1 Total Consumption of Butter and Milkfat Products (1993)

Country	1000 tons
Austria	33.8
Australia	58.3
Belgium	70.0
Canada	84.776
Switzerland	37.5
Germany	555.9
Denmark	21.5
Estonia	8.91
Spain	9.0
Finland	27.0
France	389.8
United Kingdom	205
Hungary	9.7
India	58.51
Iceland	0.589
Italy	98
Japan	92
Netherlands	50.4
Norway	9.7
New Zealand	31.9
Sweden	19.9
United States	533
South Africa	14.748
Total	2420

Source: Bulletin of IDF No. 301, 1995.

ture of butter. This happens in churning of cream, and, as a result, milkfat is concentrated in the product. Butter contains 80% milkfat (typically 80–81%), 17% moisture, 1% carbohydrates and protein, and 1.2–1.5% sodium chloride (with no salt, the milkfat increases to 82–83%). The pH of sweet cream butter (unfermented) is about 6.4–6.5. Many countries allow sodium chloride and lactic cultures as the only nonmilk additives in butter (Milner, 1995). Some countries allow neutralization of cream and addition of natural coloring agents to adjust for seasonal variation in colorant in the cream (e.g., annato, carotene, and turmeric).

There are two kinds of butter: sweet cream, which may or may not be salted, and ripened-cream butter. In ripened cream butter, citrate in cream is fermented by certain lactic acid bacteria to produce acetoin and diacetyl; the latter imparts a characteristic flavor to the product. Ripened-cream butters are more

popular in Europe, whereas unripened or sweet-cream butter is preferred in the United States, Ireland, England, Australia, and New Zealand (Adams and Moss, 1995).

When whey produced during cheese making is passed through a separator, the result is whey cream. Whey cream is processed into butter, usually as a blend with sweet cream. Butter from a $\leq 20\%$ whey cream and sweet cream blend may be indistinguishable from that made from 100% sweet cream. Butter is also manufactured from neutralized or nonneutralized whey cream, usually as a blend with sweet cream.

II. MANUFACTURE OF BUTTER

Review of Figs. 1–12 will give the reader an understanding of the complete butter-making process, both continuous and batch methods. The manufacture of butter (Fig. 12) is uniquely characterized by the following three processes:

1. Concentration of the fat phase of milk. This is done by separation or standardization of milk which results in cream.
2. Crystallization of the fat phase. Large numbers of small solid fat crystals in globular form are required, with each globule surrounded by liquid fat. Although pasteurization of cream yields a fully liquefied

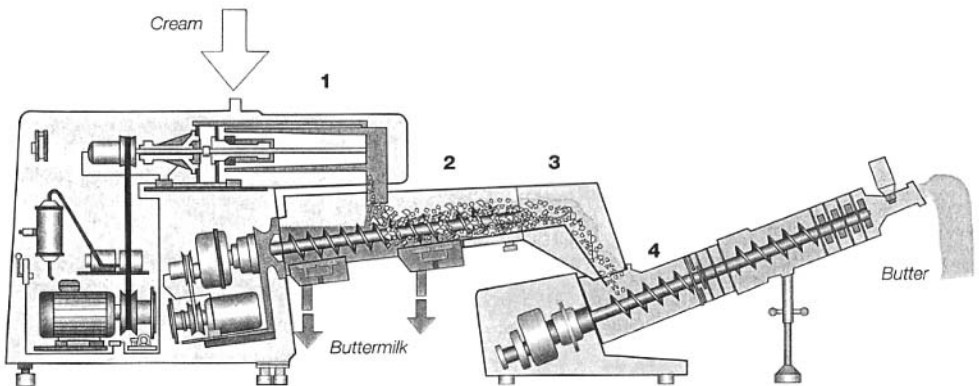

Figure 1 Continuous butter churn. (1) Churning cylinder containing beaters to break emulsion. (2) Separation section where buttermilk is drained. (3) Squeeze-drying section where initial working begins and where salt is added as a slurry. (4) Second working section where uniform moisture and salt dispersion occur and texture is finalized. (Courtesy of Dairy Processing Handbook. Tetra Pak Processing Systems AB, Lund, Sweden.)

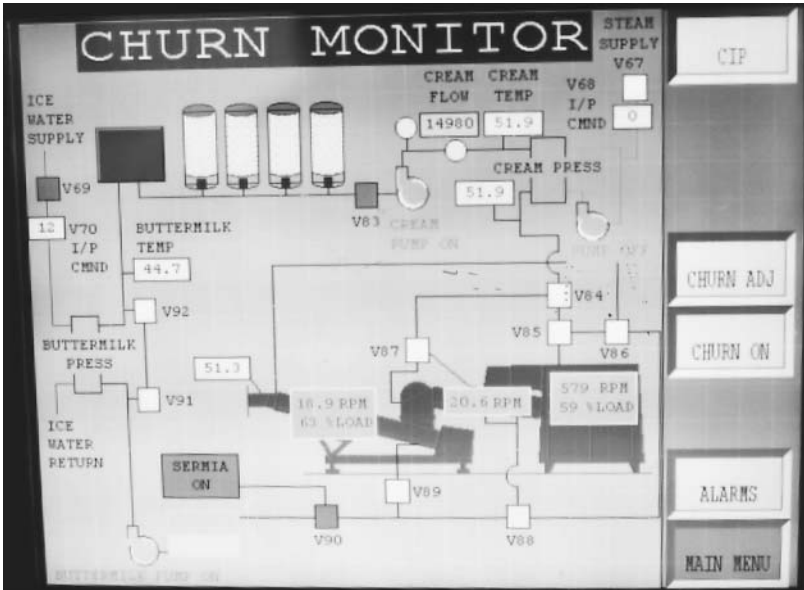

Figure 2 Control panel display. Control and monitoring of the churning process is affected at this point. A flow diagram through the churning process is shown. Figures 2–9 illustrate modern, high-speed, sanitary production of butter.

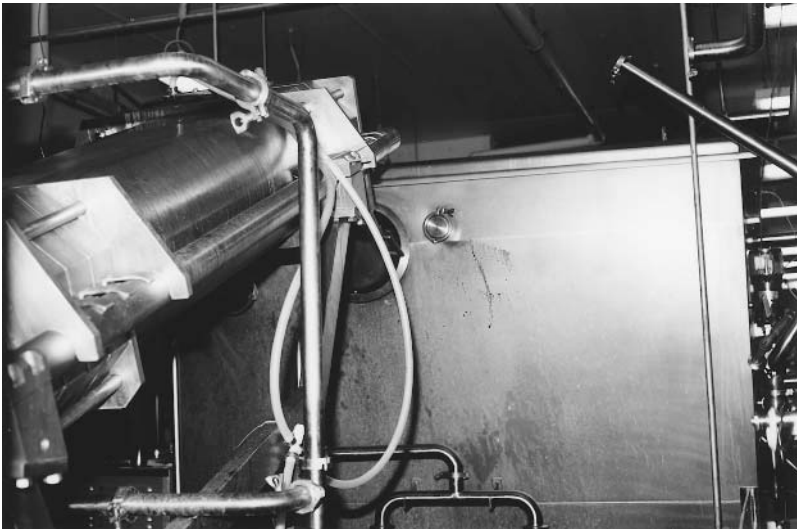

Figure 3 Butter is delivered from the turret end of the continuous churn into a covered silo.



Figure 4 Butter is discharged into the covered silo.



Figure 5 Butter in covered silo moving to a rotary positive displacement pump by augers.

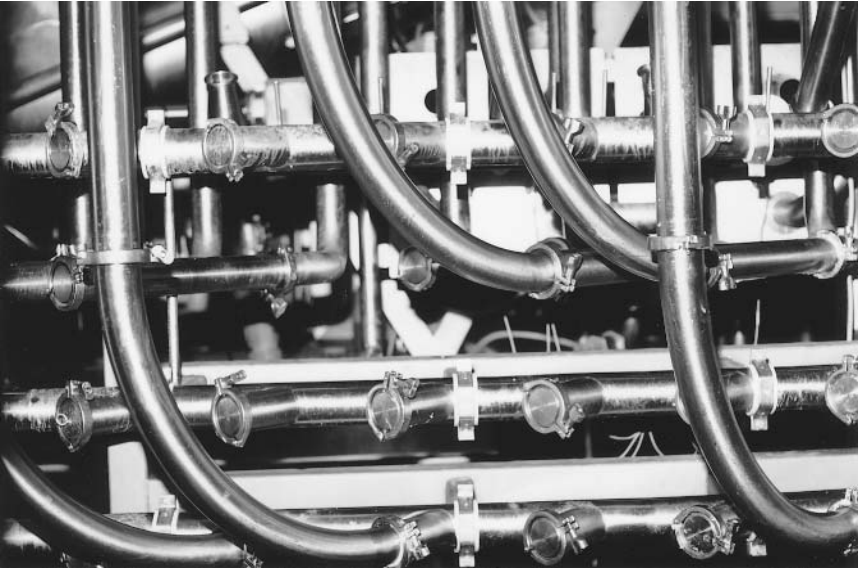

Figure 6 Distribution of butter to packaging machinery through a manifold.



Figure 7 Infrared light sensor (*arrow*) monitors level of butter in hopper and signals computer which controls off/on of delivery pump and an air-operated valve.

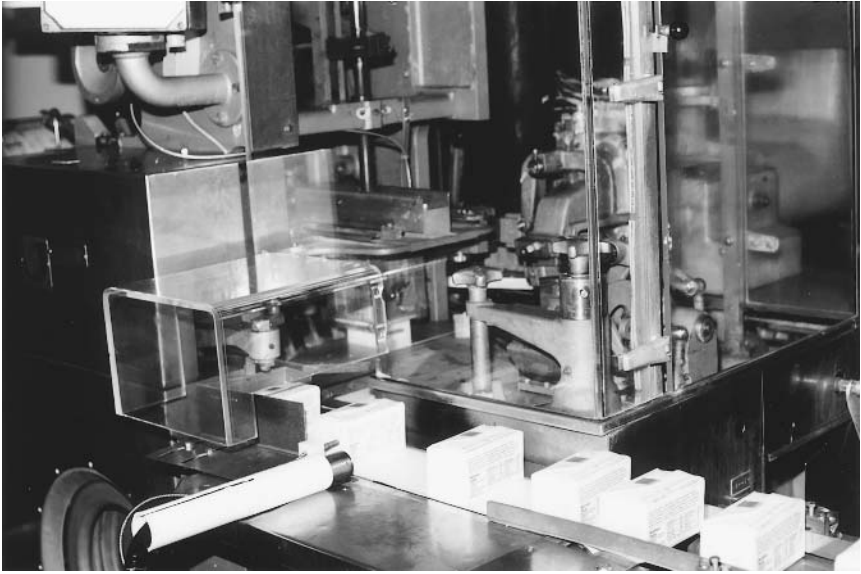

Figure 8 Wrapping of 1-lb prints of butter.

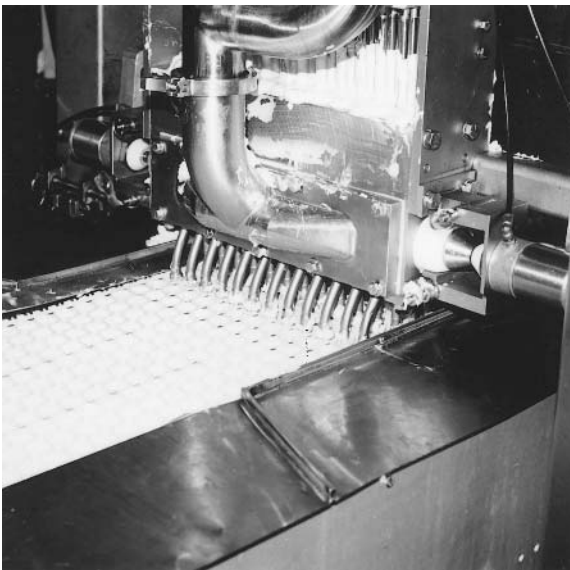

Figure 9 Filling of butter cups on a Form-Fill-Seal machine (Hooper Engineering, Sarasota, FL).

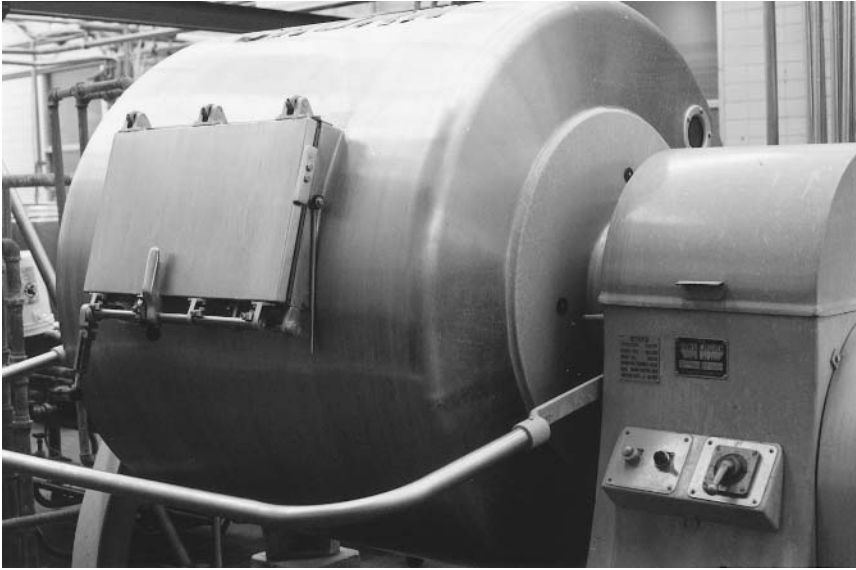

Figure 10 A batch churn with controls. A few batch churns continue to operate in the United States.

milkfat, cooling and tempering for at least 4 h at approximately 10°C is necessary to develop an extensive network of stable fat crystals surrounded by liquid milkfat. In making ripened-cream butter, addition of lactic acid bacteria to pasteurized cream cooled to 16°C is followed by incubation until a pH near 5 is attained. Cooling to 3–5°C stops the fermentation followed by warming to 10°C immediately before churning. This technique controls the fermentation while allowing for liquid fat on the globule exterior.

3. Phase separation and formation of a plasticized water-in-oil emulsion. Churning breaks the oil-in-water (o/w) emulsion and results in a plastic, water-in-oil (w/o) emulsion. The phase inversion occurs in both batch and continuous churns. During churning, vigorous agitation is used to disrupt the membrane on each milkfat globule. When the emulsion breaks, milkfat globules have formed pea-sized granules. Continued aggregation of fat globules forms a continuous matrix at an optimal temperature. The optimal temperature is dependent on triglyceride composition and season of the year; for example, 10°C summer and 11°C winter (Brunner, 1976). Churning is inefficient with homogenized cream or if the milkfat is too liquid or solid (too warm or too



Figure 11 Interior view of a batch churn showing vanes on outer edge, inspection window, and center tube which can have chilled water circulated through it to control product temperature. Butter is removed by one of two ways: (a) manually with metal scoops or (b) by dumping the butter into a boat (hopper) positioned beneath the churn. The boat is then wheeled to the packaging area.

cold, respectively). The proper blend of liquid fat surrounding solid fat is necessary. The optimum temperature for continuous churning is from research conducted on batch churns to minimize fat losses. Continuous churn operations require similar cream conditions to those for batch churns to control fat losses to buttermilk. Using batch churns, researchers found cream must “break” or aggregate into pea-sized granules in 45 min to minimize fat losses in buttermilk. These same principles of operation have been used in developing butter manufacturing techniques with the continuous churn. Cream is pasteurized at a minimum temperature of 85°C and held for at least 15 s at that temperature. Research proved that high-temperature pasteurization was necessary to allow for frozen (−30°C) storage of butter for 2 years as with Commodity Credit Corporation (CCC) purchases of surplus product. Lipase native to milk, in particular, may reactivate with lesser thermal treatment resulting in spoilage of butter by hydrolytic rancidity.

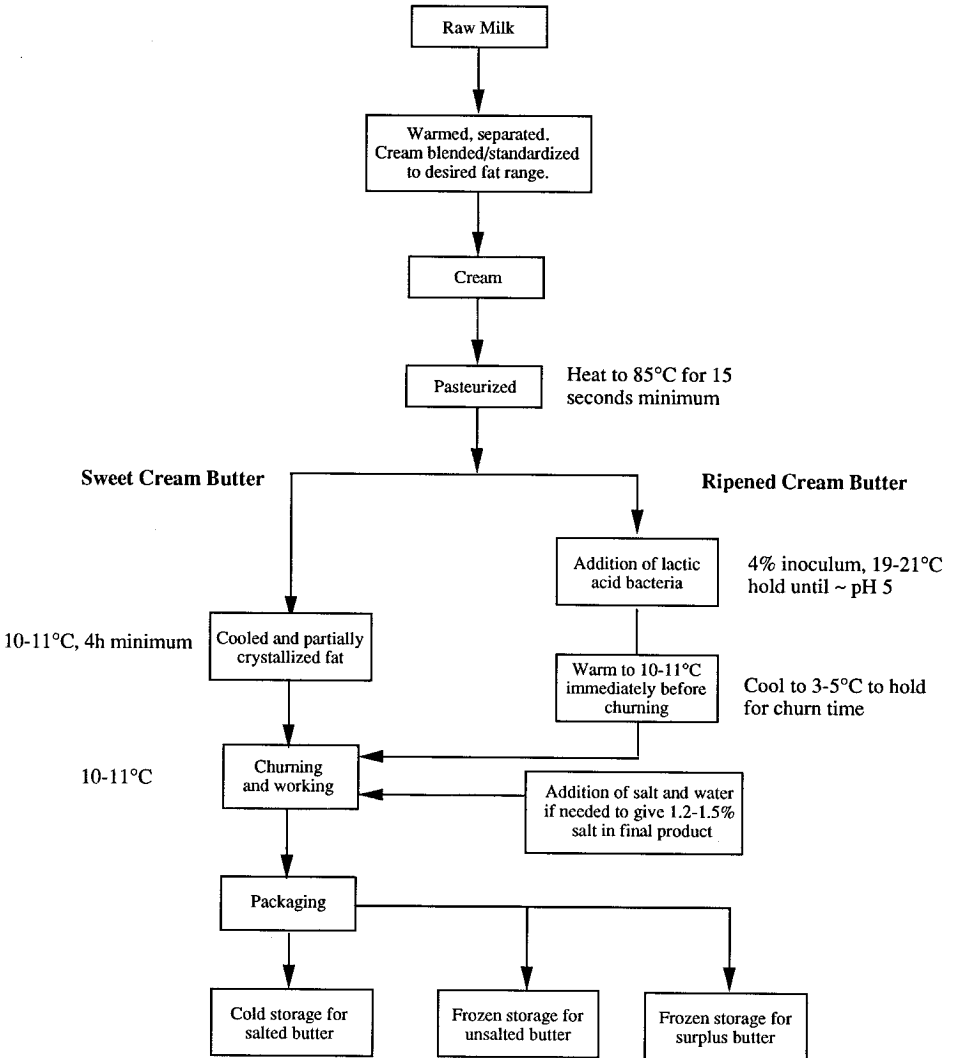

Figure 12 Production of butter.

Working of butter accomplishes two purposes: first, even distribution of moisture and salt in tiny droplets, and second, to allow for fat crystal growth to increase spreadability and to minimize brittleness of the product. After churning and working, butter is salted. Salting is done near the end of working in a continuous churn and at moisture standardization in a batch churn to prevent loss of salt. Packaging occurs after salting and may be done directly into retail portions or in bulk containers (25 and 31 kg are common) (Varnam and Sutherland, 1994). National intervention boards in the European Economic Community stipulate a storage temperature of -15°C ; however, a lower temperature is frequently used, particularly for unsalted butter. A temperature of -30°C was effective for storing butter in excess of 1 year (Varnam and Sutherland, 1994). Stored frozen butter is later thawed and microfixed and then packaged into retail containers. Microfixing is a mechanical process that reestablishes the physical structure of butter lost as a result of freezing. Butter from different manufacturers may be blended together during repackaging. Without microfixing, butter will have texture problems (lack of spreadability) and may show moisture leakage.

Thus, butter manufacture involves partial or complete separation of cream from raw milk, pasteurization, possible fermentation by added lactic acid bacteria (when ripened-cream butter is manufactured), churning, working, salting, packaging, storage, and perhaps later repackaging (see Fig. 12). All of these activities impact on the microflora of the final product.

III. MICROBIOLOGICAL CONSIDERATIONS IN BUTTER

The microbiology of butter reflects the microflora present in pasteurized cream from which it is made, water added at the time of salting butter, sanitary conditions of process equipment, manufacturing environment, and conditions under which the product is stored. Intrinsic properties of butter, for example, a_w , pH, salt content, uniformity of moisture distribution and droplet size, all impact microbiological stability.

A. Cream

The main source of microorganisms in butter made under excellent sanitary conditions is cream. Raw milk may be contaminated with a wide variety of pathogenic and spoilage microorganisms. The microflora of raw milk is related to that found in and on the cow's udder, milk-handling equipment, and storage conditions (Jay, 2000). Proper handling, pasteurization, and storage conditions should result in a predominantly gram-positive microflora in milk. Psychrotrophic *Bacillus* spp. (United States and Europe) and *Clostridium* spp. (Europe) have been found in 25–35% and 8% of raw milk samples, respectively (Jay, 2000; IDF/FIL,

1994). These organisms survive pasteurization of cream. A review of pathogenic microorganisms in raw milk was prepared by the International Dairy Federation (IDF/FIL, 1994). (Also see Chapters 1 and 13.)

B. Importance of Pasteurization

The Code of Federal Regulations (21 CFR 58.334) stipulates that pasteurization of cream for butter manufacture will be at or above 85°C for 15 s. This thermal treatment minimizes reactivation of lipase native to milk. Further, after 2 years of frozen storage at -30°C, resultant butter will still have a score of 92 or grade A. Moreover, there are further benefits to this process. Many microorganisms are inactivated. However, there is a lack of research data to show destruction of enzymes from psychrotrophic bacteria during this thermal exposure. Because finished butter is stable during frozen storage, it is thought that all enzymes were destroyed. Pasteurization of cream from raw milk is designed to eliminate vegetative microbial pathogens and reduce numbers of potential spoilage organisms. In the United States, cream must contain not less than 18% fat. However, heat-resistant microbes and spores of *Bacillus* and *Clostridium* will survive. Temperatures between 95 and 112°C are commonly used to inactivate them (Schweizer, 1986). Cream is also heated to inactivate lipases (which cause hydrolytic rancidity in butter), reduce intensity of undesirable flavors by vacuum treatment (e.g., from feed ingredients), activate sulfhydryl compounds (which can reduce autooxidation of butter), and liquefy milkfat for subsequent efficient churning (Schweizer, 1986).

C. Ripening

Many people in western and northern Europe and a few in the United States prefer the flavor of butter manufactured from microbiologically ripened cream (Pesonen, 1986). Traditionally, pasteurized cream is adjusted to 21°C and inoculated with lactic cultures composed of pure or mixed strains of *Lactococcus lactis* subsp. *lactis*, *Lc. lactis* subsp. *cremoris*, *Leuconostoc mesenteroides* subsp. *cremoris*, and *Lc. lactis* subsp. *lactis* biovar *diacetylactis*. Ripening occurs for 4–6 h until a pH of about 5 is achieved, and then cream is cooled to stop the fermentation. In this process, spoilage microorganisms are controlled primarily through the bacteriostatic effect of lactic acid produced by the starter culture.

D. NIZO Method

The NIZO method (Kimenai, 1986) for producing a cultured butter is allowed in several countries and is used by many dairies in western Europe. In the NIZO method, starter culture is not added to cream, but instead, a mixture of diacetyl-

rich permeate and starter cultures is worked into butter. Fermentation of partly delactosed whey or other suitable media containing milk components by lactic acid bacteria (i.e., *Lactobacillus helveticus*) continues for 2 days at 37°C, and then the medium is ultrafiltered to remove proteins and bacteria and to further concentrate the medium (Kimenai, 1986). During ultrafiltration, macromolecules are removed and concentrated in the retentate, whereas low molecular weight solutes pass through into the permeate stream. The pH of butter made with the permeate from this process is more easily adjusted in the desired range of 4.8–5.3. This permeate can be stored at 4°C for more than 4 months under proper conditions. Advantages cited for this process are numerous (Kimenai, 1986).

Homofermentative lactic acid bacteria such as *Lc. lactis* subsp. *lactis* and *Lc. lactis* subsp. *cremoris* are used to produce lactic acid from lactose in dairy products. However, flavor production requires addition of a heterofermentative organism such as *L. mesenteroides* subsp. *cremoris* or *Lc. lactis* subsp. *lactis* biovar *diacetylactis* to produce diacetyl (Jay, 2000). Diacetyl, in addition to imparting flavor, inhibits gram-negative bacteria and fungi (Jay, 2000).

E. Churning and Working

The bacterial load of buttermilk is typically greater than that of cream or butter (Milner, 1995). When culture-ripened cream is used to manufacture butter, most starter culture organisms are retained in buttermilk; however, some remain in butter. In several studies, butter made from cultured cream retained 0.5–2.0% of the culture organisms present in cream (Hammer and Babel, 1957). Olsen et al. (1988) found numbers of *Listeria monocytogenes* were 6.7–15.0 times higher in pasteurized but subsequently inoculated creams than in butter manufactured from the same cream. In an earlier study (Minor and Marth, 1972), *Staphylococcus aureus* behaved similarly. These organisms are gram positive, and it is unclear how other microorganisms with different cell wall and membrane structures distribute themselves between cream and butter. Diacetyl content of milkfat increases during churning; agitation during churning favors oxidative processes needed for diacetyl production (Foster et al., 1957). The pH of salted butter can prohibit formation of diacetyl (Foster et al., 1957).

F. Moisture Distribution During Churning and Working

From 10 to 18 billion droplets of water are dispersed in 1 g of the water-in-oil emulsion that is butter (Hammer and Babel, 1957). Given the low microbial load expected in pasteurized sweet cream (less than 20,000 cfu/mL) (Jay, 2000), most of the droplets are sterile. This depends on size and degree of dispersion of drop-

lets and the microbial level in cream (Hammer and Babel, 1957). The diameter of water droplets in conventionally made butter has been reported at <1 to >30 μm (Brunner, 1976).

The number of water droplets greater than 30 μm in diameter is inversely proportional to the time of working during conventional (batch churn) butter manufacture (Hammer and Babel, 1957). A consequence of uneven distribution of droplets containing microorganisms is a high degree of nonhomogeneity regarding microbial distribution in butter. Inadequate working of the butter in batch churns results in poor dispersion of water droplets and promotes microbial spoilage (Hammer and Babel, 1957; Foster et al., 1957). Further, this defect can be observed on a trier in the form of moisture droplets. The defect is called "leaky" butter and results in a reduced score. This implies that availability of nutrients or inhibitor is limited by the fine dispersion of water droplets (Foster et al., 1957). Droplet size ideally is less than 10 μm (Varnum and Sutherland, 1994).

G. Washing and Salting

Butter granules may be washed to remove excess buttermilk (Foster et al., 1957); however, this is not often done today. Salt added to butter inhibits microbial growth. However, salt must be distributed evenly in the moisture phase of butter effectively to inhibit microbial growth in water droplets. Insufficient working results in a nonhomogeneous distribution of salt in the water droplets (Hammer and Babel, 1957; Milner, 1995). Salt creates an osmotic gradient between salt granules and buttermilk during working. This tends to cause aggregation of water droplets and can lead to free moisture ("leaky" butter) and a color defect called "mottling." Adequate working and use of finely ground salt or salt flour can minimize this defect (Varnam and Sutherland, 1994).

The use of brine to salt butter is restricted to products with less than 1% salt, because the brine cannot contain more than 26% salt (w/w). Mostly, slurries of salt in saturated brine solutions containing up to 70% w/w sodium chloride are used. Salt granules used to produce a slurry should be less than 50 μm in diameter. Salt in the slurry should also be of high chemical purity, with insignificant levels of lead (<1 ppm), iron (<10 ppm), and copper (<2 ppm) (Varnam and Sutherland, 1994).

The microbiological quality of water used for washing or for brines is critical to production of a safe and stable product. Water with less than 100 cfu/mL total aerobic count when plates are incubated at 22°C and less than 10 cfu/mL total aerobic count when plates are incubated at 37°C has been deemed to be acceptable (Murphy, 1990). Formerly, wash water was chilled and chlorinated at 10 ppm 2 h before use to control microflora. Little if any butter washing is done today.

Listeria survive in a saturated brine solution held at 4°C for 132 days (Mitscherlich and Marth, 1984). Thus, brines used to salt butter must be free of *Listeria*. Water is frequently contaminated with pseudomonads, and consequently care must be taken to insure water and brines used are free of these bacteria. The most common form of spoilage in butter occurs with species of *Pseudomonas* (Jay 2000; Milner, 1995). Addition of salt to butter lowers the freezing point so that psychrotrophic microorganisms present may be able to grow at less than 0°C. Some psychrotrophic organisms multiply in salted butter stored as low as -6°C (Hammer and Babel, 1957).

Distribution of salt in the moisture phase of butter has less impact on growth of yeasts and molds on the surface of butter as compared to bacteria (Hammer and Babel, 1957). Humid conditions appear to have a greater impact on mold growth than does the material on which they grow. Bacterial spoilage may occur in areas of butter with low salt in large droplets of moisture (poor working).

Varnam and Sutherland (1994), Kimenai (1986), and Munro (1986) have provided more detailed descriptions of continuous butter manufacturing processes.

H. Packaging

In batch operations, butter is loaded directly from the churn into hoppers and wheeled to packaging machines. Handling butter this way exposes it to air, workers, plant environment, and ambient temperatures that may accelerate spoilage. Control of the microbiological quality of air in the packaging room is therefore important. HEPA (High Efficiency Particulate Arrester) quality air with the filtration after temperature modification is desired. Practices that result in standing water on the floor or residual and spilled product facilitate growth of environmental contaminants. Practices that aerosolize contaminants often produce unacceptable levels of microbiological contamination in the air. Thus, maintaining dry conditions in the plant is preferred. Numerous approaches can be taken to monitor microbiological air quality, which include sedimentation, impaction on solid surfaces, impingement in liquids, centrifugation, and filtration (Hickey et al., 1992). Air quality is particularly important in butter produced from continuous-type churns that may incorporate up to 5% air into the product (if a vacuum deaerator is not used) (Varnam and Sutherland, 1994). Most whipped butter does not have processing room air incorporated but instead uses purified compressed nitrogen gas. Gases used must be of acceptable microbiological quality.

Personnel hygiene is critical at this point of butter manufacture, because contaminants from hands, mouth, nasal passages, and clothing may be transmitted to butter during packaging. Few continuous churns are arranged to discharge product directly into the receiving hopper of packaging machinery (Varnam and Sutherland, 1994). However, to ensure uninterrupted operation, it is common to

transfer butter to a butter boat (open) or covered silo. Covered silos minimize the risk of further contamination from the plant environment. Screw augers in the bottom of the boat or silo move butter to the suction side of a rotary positive displacement pump which moves butter from the boat or silo to packaging equipment. Direct packaging into consumer-size containers is preferable over bulk packaging, because such butter must be reworked and repackaged before sale. Such reworking increases the risk of contamination and subsequent spoilage of butter (Milner, 1995).

Cardboard boxes lined with vegetable parchment, parchment aluminum foil laminate, or a variety of plastic films are typically used for bulk packaging of butter (Varnam and Sutherland, 1994). Polyethylene is the preferred material based on its physical properties (low density, high impact, cost effectiveness, absence of copper, and near sterile condition). Parchment, which supports mold growth under humid conditions, is still frequently used (Varnam and Sutherland, 1994). Retail butter packs are typically wrapped in parchment, waxed parchment, or foil/parchment laminate and overwrapped with a cardboard container. Odors in storage refrigerators will permeate and ultraviolet rays from light will penetrate parchment wraps more rapidly than other wrappers and result in oxidized flavor. Individual butter packs, for example, continentals, cups, and chips, used in restaurants and food service are made at the time of packaging by appropriate high-speed equipment.

I. Pathogen Survival and Growth in Butter

Research conducted using the following pathogenic microorganisms has shown their growth in butter products: *L. monocytogenes* in butter at 4 and 13°C (made from inoculated cream) (Olsen et al., 1988), *S. aureus* in lightly salted (1% w/w) whey cream butter at 25 and 30°C (Halpin-Dohnalek and Marth, 1989b), and inoculated whipped butter at 25°C (Halpin-Dohnalek and Marth, 1989a). *L. innocua* (not a pathogen but frequently associated with *L. monocytogenes* in environmental samples) was found in butter by Massa et al. (1990).

J. Food Poisoning Outbreaks

The incidence of documented food poisoning associated with butter is low. This is partially attributed to widespread use of pasteurization at elevated temperatures. Postpasteurization environmental contamination of cream or butter represents the greatest risk to butter contamination and spoilage. Several outbreaks of staphylococcal intoxication related to butter have been reported in the United States (Centers for Disease Control, 1970, 1974, 1977). In one instance, gastrointestinal illness developed in 24 customers and employees of a department store restaurant and was traced to whipped butter manufactured from whey cream (Centers for

Disease Control, 1970). The same butter used to manufacture the implicated whipped product also resulted in one case of gastroenteritis. This butter contained 10 ng of staphylococcal enterotoxin A/g. In 1977, more than 100 customers of pancake houses in the Midwest became ill after consumption of whipped butter (Centers for Disease Control, 1977).

K. Spoilage

The two principal types of microbial spoilage of butter are surface taint and hydrolytic rancidity (Jay, 2000). Both conditions can be caused by growth of *Pseudomonas* spp. Some *Pseudomonas* spp. are psychrotrophic (Kornacki and Gabis, 1990) and produce proteases and lipases which may survive pasteurization (Cousin, 1982) and which hydrolyse protein and fat, respectively. *P. putrificiens* can grow on butter surfaces at 4 to 7°C and produce a putrid odor within 7–10 days (Jay, 2000). This odor may result from liberation of certain organic acids, especially isovaleric acid (Jay, 2000).

Rancidity, the second most common spoilage defect, is caused by both microbial and nonmicrobial lipases, which degrade milkfat to free fatty acids. *P. fragi* and sometimes *P. fluorescens* are associated with this defect (Jay, 2000). Mold growth on butter also can cause hydrolytic rancidity for the same reasons (Irbe, 1993). Molds that can cause this defect in butter include some in the genera *Rhizopus*, *Geotrichum*, *Penicillium*, and *Cladosporium* (Irbe, 1993). Less common spoilage defects include malty flavor, skunk-like odor, and black discoloration. These defects are caused by *Lc. lactis* var. *maltigenes*, *P. mephitica*, and *P. nigrificiens*, respectively. Other microbially induced color changes may result from surface growth of various fungi that produce colored spores (Jay, 2000). Heat-resistant proteases and lipases produced by pseudomonads that may grow during storage of raw milk or cream may result in spoilage of butter after manufacture even though spoilage organisms may have been destroyed by pasteurization.

L. Sources of Environmental Contamination

The necessity for milk, cream, and wash water to be of high microbial quality and the importance of pasteurization to public health have been described. Yeasts and molds are particularly resistant to dry conditions when compared to bacteria. Unlike bacteria, many of these fungi can grow at water activities (a_w) below 0.84. A few can grow below an a_w of 0.65 (Troller and Christian, 1978). A study was reported in which molds would not grow on butter held at or below 70% humidity (Hammer and Babel, 1957). Therefore, to prevent growth of osmotolerant yeasts and molds, a humidity of 60% or less should be maintained in the processing environment.

Ineffective sanitation of processing equipment could result in product contamination from equipment such as piping, pumps, silos, or other equipment (Hammer and Babel, 1957). In our experience, the backplate of older positive displacement pumps (e.g., from pasteurized cream storage tanks) may be neglected during sanitation and become a microbial growth niche, which in turn provides an inoculum to the product stream. Stress cracks in double-walled, insulated tanks can also provide a source of product contamination when the insulating material between walls becomes wet. Further, published data validating effective cleaning and sanitation on continuous churns through use of microbiological swabs are lacking.

Personal hygiene of employees working with butter is also important. Cross contamination from hands, mouths, nasal passages, and clothing must be precluded (Hammer and Babel, 1957). Handling butter in restaurants may also result in cross contamination of a product; for example, when 1-lb prints are divided with knives used for cutting meat or when whipped butter is scooped with improperly sanitized equipment (Halpin-Dohnalek and Marth, 1989a).

IV. MICROBIOLOGICAL CONTROL OF BUTTER

A. Factors Limiting Microbial Growth in Butter

A variety of extrinsic (e.g., temperature) and intrinsic (e.g., salt in the moisture phase) factors combine to control the microflora of butter. Most important among these are (a) fine and uniform dispersion of moisture phase, (b) addition and uniform dispersion of salt, (c) low-temperature storage, and (d) use of lactic cultures (in ripened cream butter) (Hammer and Babel, 1957; Olsen et al., 1988). Microbial growth is proportional to availability of nutrients and related to size of water droplets in butter (Verrips, 1989). Thus, the smaller and more uniform the droplets, the lower the potential for microbial growth. Salt must also be distributed evenly in the moisture phase of the product effectively to inhibit microbial growth in contaminated water droplets. The approximate salinity of moisture in butter with 1.5% salt is 9%; this will inhibit growth of many bacteria. However, working may not result in a homogeneous distribution of salt in the water droplets (Milner, 1995; Hammer and Babel, 1957). Data suggest that dispersion of water droplets, salt, and bacteria in butter made by continuous churns may be more uniform than in butter made with batch churns. Aerobic plate counts revealed a steady decrease in microbial contaminants in butter made in continuous churns compared with counts obtained on butter made from batch churns (O'Toole, 1978). Salt-free droplets were found in freshly worked salted butter made with a batch churn (Hammer and Babel, 1957). Technological developments that allow for uniform dispersion of moisture, salt, and bacteria enhance both safety and shelf-life of butter.

Storage of salted butter at freezing temperatures is not adequate to guarantee complete cessation of microbial growth because of the depressed freezing point in the moisture phase of the product resulting from elevated salt content and presence of other dissolved solutes. However, freezing is an effective means of storage for unsalted butter. O'Toole (1978) provided data that suggested that the lowest temperature limit for microbial metabolic activity in salted butter was -9°C . As a result of sensory evaluation, the flavor of butter held at -6°C was marginally less after 12 weeks; however, butter stored 8 weeks at 4 or 10°C dropped about one point in flavor score (O'Toole, 1978).

Some countries allow the use of potassium sorbate and sodium benzoate as preservatives in butter. However, countries such as the United States, United Kingdom, France, and Luxembourg prohibit preservatives in butter. Addition of 0.1% potassium sorbate inhibited growth of coliforms and molds in naturally contaminated butter (Kaul et al., 1979). The inhibitory effect was enhanced when 2% salt was added along with 0.1% potassium sorbate. This inhibition occurred in all samples stored 4 weeks at -18 and 5°C .

Caution should be exercised in selection of any additives blended into butter products for flavor (e.g., honey, garlic, chopped herbs, and fruits), because they may contribute additional enzymes and microflora to the product. For example, unpasteurized honey added to butter will cause hydrolytic rancidity within 2 weeks because of lipase in the honey. Butter colorants that have not been mishandled have rarely contributed to the microflora of cream or butter (Foster et al., 1957).

B. Quality Assurance

Any quality assurance program should incorporate maintenance and documentation of good manufacturing practices (GMPs) and hazard analysis critical control points (HACCP).

C. Hazard Analysis Critical Control Points (HACCP)

An obvious critical control point for butter manufacturers is pasteurization or repasteurization of cream received at the manufacturing site. Control of the microflora in the manufacturing environment is also critical. Each plant must evaluate its individual process and develop its own risk assessment and HACCP plan (Smittle, 1992). An environment sampling protocol should be aimed at monitoring for *L. monocytogenes*, *S. aureus*, and *Salmonella*. Recalls of butter because of *L. monocytogenes* contamination were reported as recently as 1994 (Ryser, 1999). Faust and Gabis (1988) have recommended areas of food plant environments that can be targeted for sampling for pathogens. Discovery of *Salmonella* or *Listeria* in the environment requires immediate corrective action with docu-

mentation of the success of that action. Irbe (1993) has recommended that manufacturers of whipped butter develop in-plant guidelines for aerobic plate count and *S. aureus* at critical control points of manufacture. Finished products must be free of *Salmonella*, and *L. monocytogenes* and should be free of *Escherichia coli* (Irbe, 1993).

Testing for these organisms can be done to validate success of the manufacturer's HACCP program. All testing of pathogens must be done away from the manufacturing site. Most in-plant laboratories are not equipped with the needed accessories to prevent spread of pathogens to the plant environment. Manufacturers should also test for lipolytic and psychrotrophic spoilage organisms in the finished product and develop a three-class attribute sampling plan (Smittle, 1992). These data can be used to establish goals and measure success based on principles of continuous quality improvement (Crosby, 1984). Sanitation of equipment used to manufacture product should be assessed regularly by testing environmental swabs for selected microbes.

The authors of this chapter recommend that pasteurized cream for butter manufacture has ≤ 5000 cfu/g (APC) with < 2 coliforms/g. Finished butter should contain ≤ 5000 cfu/g (APC), < 2 coliforms/g, no staphylococcal enterotoxins, no *Salmonella* in 375 g, no *L. monocytogenes* in 25 g, and < 10 yeasts and molds/g.

V. MICROBIOLOGY OF RELATED PRODUCTS

A. Definitions

Margarine, like butter, contains approximately 80–81% fat, 15% moisture, 0.6% protein, 0.4% carbohydrate, and 2.5% ash (Irbe, 1993). In margarine, edible fats, oils, or mixtures of these with partially hydrogenated vegetable oils or rendered animal carcass fats are substituted for milkfat (Code of Federal Regulations, 1994). Eighty percent fat in butter and margarine is considered too high by many individuals concerned about their diets (Varnam and Sutherland, 1994). Consequently, numerous spreads have been manufactured with lower fat contents. In many countries, there are no legal standards or definitions for these low-fat spreads. However, a working categorization has been made based on fat content (Varnam and Sutherland, 1994). *Full-fat spreads* are described as those with fat contents of 72–80%; *reduced-fat spreads* have 50–60% fat; *low-fat spreads* have 39–41% fat, and *very low-fat spreads* have less than 30% fat. Vegetable fats, mixtures of vegetable fat and milkfat, and milkfat alone have been used to develop these spreads (Varnam and Sutherland, 1994). Another trend has been production of spreads in which fat has been replaced in part or completely by a variety of substances such as Neutrifat, Simplese, and Stellar (Varnam and Sutherland, 1994). Olestra a sucrose polyester with fatty acids, was recently (1996)

approved by the U.S. Food and Drug Administration (FDA) as a substitute for conventional fats and may appear in products in the future.

B. Dairy Spreads: Manufacture and Microbiological Considerations

Low-fat spreads are also water in oil emulsions but contain more moisture than butter. Consequently, there is increased likelihood of microbial growth in these products unless preservatives are added. The use of preservatives is allowed in some countries but not in others. Because of combining ingredients at 45°C, in an emulsifying unit, growth of thermophilic organisms (e.g., *Enterococcus faecium*, *E. faecalis*) and thermophiles may occur. Higher fat dairy spreads are typi-

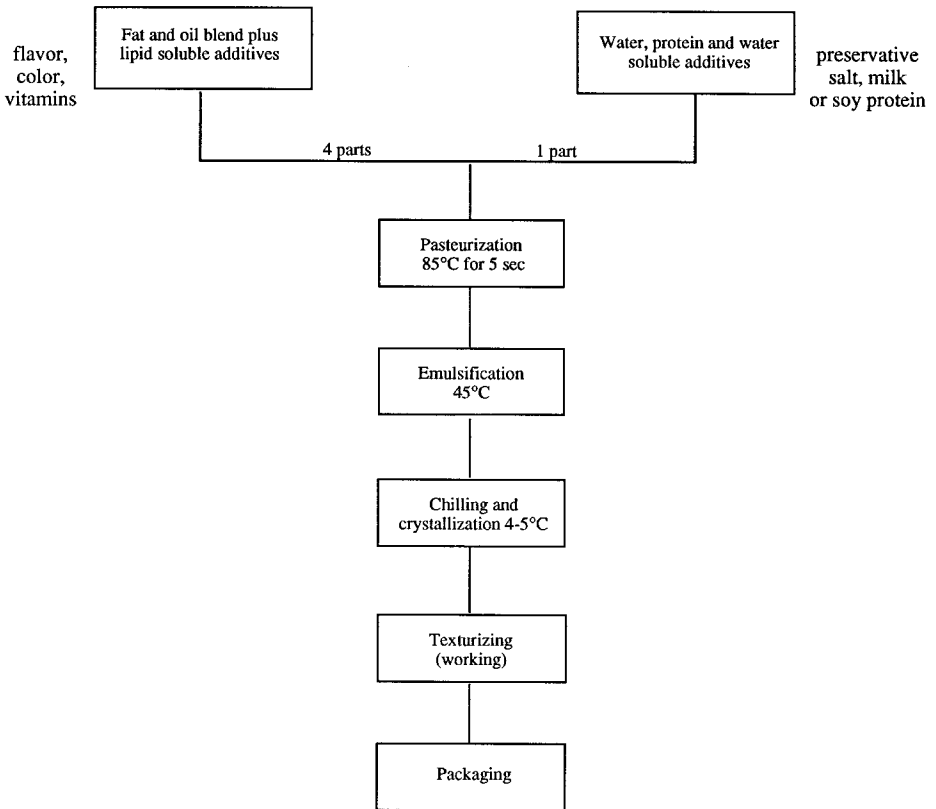

Figure 13 Manufacturing flow diagram for margarine-type products.

cally made using a swept-surface heat exchanger and texturizer where the aqueous blend of ingredients is mixed in the correct ratio with oil-soluble ingredients.

Crystallization of fat during working is critical to obtain desired consistency and spreadability in the finished product. Rapid supercooling to -10° to -20°C under high sheer conditions in the scraped surface heat exchanger initiates and maintains crystallization and disperses moisture within the fat matrix (Varnam and Sutherland, 1994). Control of cross contamination during packaging is more critical than in butter manufacture because of the higher potential for microbial growth in spreads.

Microorganisms that cause spoilage in butter have been implicated in margarine spoilage. However, vegetable fats are typically more resistant to lipolytic breakdown than is milkfat (Varnam and Sutherland, 1994). *Yarrowia lipolytica*, *Bacillus polymyxa*, and *E. faecium* are spoilage organisms of concern in low-fat spreads (Varnam and Sutherland, 1994; Lanciotti et al., 1992). Lanciotti et al. (1992) showed that *L. monocytogenes* and *Yersinia enterocolitica* can grow in "light" butter at 4 and 20°C . A class I recall of 60% butter, 40% margarine product occurred in 1992 (FDA Enforcement Report, 1992). More detailed descriptions of margarines, spreads, and industrial milkfat products can be found in the report by Varnam and Sutherland (1994). An outline of margarine and spread manufacture is shown in Fig. 13.

VI. CONCLUSION

The safety record of butter has improved considerably since the advent of cream pasteurization and improvements in churn design, sanitation, and water quality. However, rigorous adherence to GMPs with appropriate environmental sampling and HACCP are necessary to ensure the safety and prolong the shelf-life of butter and spreads.

REFERENCES

- Adams MR, Moss MO. The microbiology of food preservation. In: Food Microbiology. Cambridge, UK: The Royal Society of Chemistry, 1995, pp 55–102.
- Anderson RF. Introduction, Continuous Butter Manufacture. International Dairy Federation Bulletin No. 204. Brussels: International Dairy Federation, 1986, p 2.
- Brunner JR. Characteristics of edible fluids of animal origin: milk. In: Fennema OR, ed. Principles of Food Science. New York: Marcel Dekker, 1976, pp 619–658.
- Centers for Disease Control. Staphylococcal food poisoning traced to butter—Alabama. Morbid Mortal Weekly Rep 19:271, 1970.
- Centers for Disease Control. Probable staphylococcal enterotoxin contamination of com-

- monly produced milk shake mixes—Maryland, New Jersey, Pennsylvania, West Virginia. *Morbidity Mortality Weekly Report* 23:155–156, 1974.
- Centers for Disease Control. Presumed staphylococcal food poisoning associated with whipped butter. *Morbidity Mortality Weekly Report* 19:271, 1977.
- Code of Federal Regulations. 21 CFR 116.110. Washington, DC: Food and Drug Administration, 1994.
- Code of Federal Regulations. 21 CFR 58.334. Washington, DC: Food and Drug Administration, 1998.
- Cousin M. Presence and activity of psychrotrophic microorganisms in milk and dairy products: a review. *J Food Prot* 45:172–207, 1982.
- Crosby PB. *Quality Without Tears*. New York: McGraw-Hill, 1984.
- Faust RE, Gabis DA. Controlling microbial growth in food processing environments. *Food Technol* 42(12):81–82, 89, 1988.
- Foster EM, Nelson FE, Speck ML, Doetsch RN, Olson JC Jr. *Microbiology of Cream and Butter*. Dairy Microbiology. Englewood Cliffs, NJ: Prentice-Hall, 1957.
- Halpin-Dohnalek MI, Marth EH. Fate of *Staphylococcus aureus* in whipped butter. *J Food Prot* 52:863–866, 1989a.
- Halpin-Dohnalek MI, Marth EH. Fate of *Staphylococcus aureus* in whey, whey cream, and whey cream butter. *J Dairy Sci* 72:3149–3155, 1989b.
- Hammer BW, Babel FJ. *Dairy Bacteriology*. 4th ed. New York: Chapman & Hall, 1957, pp 442–509.
- Hickey PJ, Beckelheimer CE, Parrow T. Microbiological tests for equipment, containers, water and air. In: Marshall RT, ed. *Standard Methods for the Examination of Dairy Products*. 16th ed. Washington, DC: American Public Health Association, 1992, pp 397–412.
- IDF/FIL. *The Significance of Pathogenic Microorganisms in Raw Milk*. Brussels: International Dairy Federation. 1994.
- IDF/FIL. *Consumption Statistics of Milk and Milk Products 1993*. Bulletin No. 301. Brussels: International Dairy Federation. 1995.
- IDFA. *Milk Facts*, 1999 edition. International Dairy Foods Assn., Washington, DC.
- Irbe RJ. Microbiology of reduced-fat foods. Science for the food industry of the 21st century. In: Yalpani M, ed. *Biotechnology, Supercritical Fluids and Other Advanced Technologies for Low Calorie, Healthy, Food Alternatives*. Mount Prospect, IL: ATL Press, 1993, pp 359–382.
- Jay JM. *Modern Food Microbiology*. 6th ed. New York: Chapman & Hall, 2000.
- Kaul J, Singh J, Kuila RK. Effect of potassium sorbate on the microbial quality of butter. *J Food Prot* 42:656–657, 1979.
- Kimenai MP. Cream crystallization, Section III-NIZO method. In: *Continuous Butter Manufacture*. Bulletin No. 204. Brussels: International Dairy Federation, 1986, pp 11–15.
- Kornacki JL, Gabis DA. Microorganisms and refrigeration temperatures. *Dairy, Food Environ Sanit* 10:192–195, 1990.
- Lanciotti R, Massa S, Guerzoni M, Di Fabio G. Light butter: natural microbial population and potential growth of *Listeria monocytogenes* and *Yersinia enterocolitica*. *Letts Appl Microbiol* 15:256–258, 1992.
- Massa S, Cesaroni D, Poda G, Trovatelli LD. The incidence of *Listeria* spp. in soft cheeses,

- butter and raw milk in the province of Bologna. *J Appl Bacteriol* 68:153–156, 1996.
- Milner J. Butter and low-fat dairy spreads. In: *LFRA Microbiology Handbook*. Leatherhead, Surrey, UK: Leatherhead Food RA, 1995, pp B-1–B-15.
- Minor TE, Marth EH. *Staphylococcus aureus* and enterotoxin A in cream and butter. *J Dairy Sci* 55:1410–1414, 1972.
- Mitscherlich E, Marth EH. *Microbial Survival in the Environment: Bacteria and Rickettsiae Important in Human and Animal Health*. New York: Springer-Verlag, 1984.
- Munro DS. Alternative processes. In: *Continuous Butter Manufacture*. Bulletin No. 204. Brussels: International Dairy Federation, 1986, p. 17–19.
- Murphy MF. Microbiology of butter. In: Robinson RK, ed. *Dairy Microbiology*. Vol 2. *The Microbiology of Milk Products*. London: Elsevier, 1990, pp 109–130.
- Olsen JA, Yousef AE, Marth EH. Growth and survival of *Listeria monocytogenes* during making and storage of butter. *Milchwissenschaft* 43:487–489, 1988.
- O'Toole DK. Effect of storage temperature on microbial growth in continuously made butter. *Aust J Dairy Technol* 33:85–87, 1978.
- Pesonen H. Cream crystallization, Section II—Ripened Cream. In: *Continuous Butter Manufacture*. Bulletin No. 204. Brussels: International Dairy Federation, 1986, pp 12–13.
- Ryser, ET. Incidence and behavior of *Listeria monocytogenes* in unfermented dairy products. In: Ryser ET, Marth EH eds. *Listeria, Listeriosis and Food Safety*. 2nd ed. Marcel Dekker, New York, 1999, pp 359–409.
- Schweizer M. Heat treatment. In: *Continuous Butter Manufacture*. Bulletin No. 204. Brussels: International Dairy Federation, 1986, p 10.
- Smittle RB. Foods, quality control. In: *Encyclopedia of Microbiology*. Vol 2. New York: Academic Press, 1992, pp 219–229.
- Troller JA, Christian JHB. *Water Activity and Food*. New York: Academic Press, 1978.
- Varnam AH, Sutherland JP. Butter, margarine and spreads. In: *Milk and Milk Products*. New York: Chapman & Hall, 1994, pp 223–274.
- Verrips CT. Growth of microorganisms in compartmentalized products. In: Gould GW, ed. *Mechanisms of Action of Food Preservation Procedures*. London: Elsevier Applied Science, 1989, pp 363–399.

6

Starter Cultures and Their Use

Ashraf N. Hassan

*Minia University
Minia, Egypt*

Joseph F. Frank

*The University of Georgia
Athens, Georgia*

I. INTRODUCTION

Modern dairy microbiology began with the study of the natural acidification process that occurs when milk, cheese whey, or buttermilk (from cultured butter manufacture) are held for a time. These acidified products had long been used as inocula to produce cheese, butter, and cultured milks, but the resulting fermentations were undependable and of uneven quality. Pasteur, in 1857, was the first to demonstrate that the lactic fermentation was of microbial origin; disputing the accepted theory of the time that chemical degradation of sugar to lactic acid resulted in spontaneous generation of microorganisms (Brock, 1961). It was not until 1878 that Lister isolated pure cultures of the lactic acid bacteria responsible for milk acidification (Brock, 1961). In the 1880s, Conn in the United States, Storch in Denmark, and Weigmann in Germany demonstrated the advantages of using selected lactic acid bacteria to culture cream for butter manufacture (Knudson, 1931; Cogan, 1996). Commercial production and the use of starter cultures grew rapidly and was widespread at the beginning of the 20th century. The advantages of using starter cultures to initiate fermentation were convincing. Before the use of commercial starter cultures, Cheddar cheese took 6–7 h to produce, and much of the product was of too poor a quality to be sold (Conn, 1895). Slow fermentation was also a public health threat, because milk for cheese manufacture was not pasteurized. Currently, most cultured dairy products are produced using

commercial starter cultures that have been selected for a variety of desirable properties in addition to rapid acid production. These may include flavor production, lack of associated off-flavors, bacteriophage tolerance, ability to produce flavor during cheese ripening, salt tolerance, polysaccharide production, bacteriocin production, and heat sensitivity.

A starter culture is any active microbial preparation intentionally added during product manufacture to initiate desirable changes. These microbial preparations can consist of lactic acid bacteria, propionibacteria, surface-ripening bacteria, yeasts, and molds. Starter cultures have a multifunctional role in dairy fermentations. Their ability to produce acid rapidly aids in separation of curd from whey during cheese manufacture, modifies texture of cheeses and cultured milks, and enhances preservation. Production of low molecular weight compounds such as diacetyl contributes to flavor and aroma. Gas production can cause eye formation in cheese. Development of flavor and changes in texture during ripening of cheeses is associated with enzymes originating from bacterial and fungal cultures, depending on the cheese variety.

Lactic starter cultures may consist of single strains used alone or in combinations or undefined mixtures of strains (mixed-strain cultures). Cultures can also be either mesophilic (optimal growth at approximately 26°C) or thermophilic (optimal growth at approximately 42°C) (Cogan, 1996). Mesophilic mixed-strain starter cultures can be grouped by composition: O (or N) cultures consist of lactococci that do not ferment citrate; B (or L) cultures contain *Leuconostoc* spp. and lactococci that do not ferment citrate; D cultures contain both citrate-fermenting and citrate-nonfermenting lactococci but no *Leuconostoc* spp.; BD cultures contain *Leuconostoc* spp. as well as lactococci found in D cultures (Lodics and Steenson, 1993). The type of mixed strain culture used for a specific cheese variety depends primarily on the amount of gas production (if any) that is desired. Thermophilic starter cultures consist of a mixture of *Streptococcus thermophilus* and *Lactobacillus* sp., usually either *Lb. helveticus*, *Lb. delbrueckii* subsp. *bulgaricus*, or *Lb. delbrueckii* subsp. *lactis*. These cultures are used to produce Italian and Swiss cheese varieties and yogurt.

This chapter discusses characteristics of lactic acid bacteria and other microorganisms found in dairy starter cultures; their interactions, preparation, and activity measurement; inhibitors of their activity; microbial inhibitors that they produce; and their genetic modifications.

II. STARTER CULTURE MICROORGANISMS

A. General Characteristics of Lactic Acid Bacteria

All dairy fermentations use lactic acid bacteria for acidification and flavor production. Although lactic acid bacteria are genetically diverse, common characteristics of this group include being gram-positive, non-spore forming, nonpigmented,

and unable to produce iron-containing porphyrin compounds (catalase and cytochrome); growing anaerobically but being aerotolerant; and obligately fermenting sugar with lactic acid as a major endproduct. Lactic acid bacteria tend to be nutritionally fastidious, often requiring specific amino acids, B vitamins, and other growth factors, whereas being unable to use complex carbohydrates.

1. Taxonomy

There are currently 11 genera of lactic acid bacteria, of which four—*Lactobacillus*, *Streptococcus*, *Lactococcus*, and *Leuconostoc*—are commonly found in dairy starter cultures. A fifth genus, *Enterococcus*, is occasionally found in mixed-strain (undefined) starter cultures. Important phenotypic taxonomic criteria include morphological appearance (rod or coccus), fermentation endproducts (homofermentative or heterofermentative), carbohydrate fermentation, growth temperature range, optical configuration of lactic acid produced, and salt tolerance (Axelsson, 1993). rRNA sequences are used accurately to determine phylogenetic relationships among bacteria. This and other genetic methods have led to reorganization of some genera of lactic acid bacteria (e.g., reclassification of lactic streptococci to *Lactococcus* spp.).

2. Natural Habitat

Lactic acid bacteria are generally associated with nutrient-rich habitats containing simple sugars. These include raw milk, meat, fruits, and vegetables. They grow with yeast in wine, beer, and bread fermentations. In nature, they are found in the dairy farm environment and in decomposing vegetation, including silage. Some species colonize animal organs, including the mouth, intestine, and vagina. They are also part of the normal microflora of the streak canal of the mammary gland. Lactic acid bacteria isolated from natural habitats are often physiologically distinct from their starter culture variants. For example, lactococci isolated from plants ferment lactose slowly, if at all (Chassy and Murphy, 1993).

B. Characteristics of Starter Culture Genera and Species

1. Lactococcus

Lactococci (formerly group N streptococci) are the major mesophilic microorganisms used for acid production in dairy fermentations. Although five species are recognized, only one, *Lc. lactis*, is of significance in dairy fermentations. *Lc. lactis* cells are cocci that usually occur in chains, although single and paired cells are also found. They are homofermentative; when grown in milk, more than 95% of their endproduct is lactic acid (of the L isomer). Lactococci grow at 10°C but not at 45°C. They are weakly proteolytic and can use milk proteins. They hydrolyse milk casein by extracellular proteinase PrtP. However, all their peptidases

seem to be intracellular (Law and Haandrikman, 1997). There are two subspecies, *Lc. lactis* subsp. *lactis* and *Lc. lactis* subsp. *cremoris*. Differential characteristics for these subspecies are presented in Table 1. *Lc. lactis* subsp. *lactis* is more heat and salt tolerant than *Lc. lactis* subsp. *cremoris*. A variant of *Lc. lactis* (*Lc. lactis* subsp. *lactis* var. *diacetyllactis*) converts citrate to diacetyl, carbon dioxide, and other compounds. Some lactococci produce exopolysaccharide (Cerning, 1990). These variants are used to produce Scandinavian cultured milks having a ropy texture (viilli, taettamilk, and langmjolk). Another variant of *Lc. lactis* produces malty off-flavor caused by aldehyde production from amino acids (Morgan, 1976).

2. Streptococcus

The only *Streptococcus* sp. useful in dairy fermentation is *S. thermophilus*. This microorganism is genetically similar to oral streptococci (*S. salivarius*) but can still be considered a separate species (Axelsson, 1993). *S. thermophilus* is differentiated from other streptococci (and lactococci) by its heat resistance, ability to grow at 52°C, and ability to ferment only a limited number of carbohydrates (Axelsson, 1993). Most dairy products subjected to high temperatures during fermentation (>40°C) are acidified by the combined growth of *S. thermophilus* and *Lactobacillus* spp. *S. thermophilus* has limited proteolytic ability, although it possesses many types of proteolytic enzymes.

3. Leuconostoc

Leuconostoc spp. are distinguished from other lactic acid bacteria by being mesophilic heterofermentative cocci. They do not hydrolyze arginine and require vari-

Table 1 Differentiation of Lactococci Used in Starter Cultures

Characteristic	<i>Lactococcus lactis</i> subsp.	
	<i>lactis</i>	<i>cremoris</i>
Acid from		
Lactose	+	+
Galactose	+	+
Maltose	+	-
Ribose	+	-
Growth in 4% salt	+	-
Arginine hydrolysis	+	-

Source: Schleifer et al., 1985.

ous B vitamins for growth. *Leuconostoc* spp. used in the dairy industry produce diacetyl, carbon dioxide, and acetoin from citrate. Some also produce exopolysaccharide (dextran) from sucrose. Only two species of *Leuconostoc* are associated with dairy starter cultures, *Leuc. mesenteroides* subsp. *cremoris* (previously, *Leuc. citrovorum*) and *Leuc. lactis*. These are differentiated by their ability to ferment various carbohydrates. *Leuconostoc* spp. grow poorly in milk; probably because they are adapted to growth on vegetables and roots (Vedamuthu, 1994) and therefore lack sufficient proteolytic ability to grow in milk. *Leuc. mesenteroides* subsp. *cremoris* does not produce sufficient acidity in milk to coagulate it, but *Leuc. lactis* may (Thunell, 1995). In starter cultures, *Leuconostoc* spp. are combined with lactococci when production of diacetyl and carbon dioxide is desired in addition to acidification. When used in cultured milk starters, they convert excess acetaldehyde to diacetyl, thus reducing undesirable “green” flavor (Lindsay et al., 1965). *Leuconostoc* spp. do not grow well in high-phosphate phage-inhibitory media (Vedamuthu, 1994).

4. *Lactobacillus*

The *Lactobacillus* genus consists of a genetically and physiologically diverse group of rod-shaped lactic acid bacteria. The genus can be divided into three groups based on fermentation endproducts. Species in each of these groups can be found in dairy starter cultures, as listed in Table 2. Homofermentative lactobacilli exclusively ferment hexose sugars to lactic acid by the Embden-Meyerhof pathway. They do not ferment pentose sugars or gluconate. These are the lactobacilli (*Lb. delbrueckii* subsp. *bulgaricus*, *Lb. delbrueckii* subsp. *lactis*, and *Lb. helveticus*) commonly found in starter cultures. They grow at higher temperatures (>45°C) than lactobacilli in the other groups and are thermophilic. Another member of this group, *Lb. acidophilus*, is not a starter culture organism, but it is added to dairy foods for its nutritional benefits.

Facultatively heterofermentative lactobacilli ferment hexose sugars either only to lactic acid or to lactic acid, acetic acid, ethanol, and formic acid when glucose is limited. Pentose sugars are fermented to lactic and acetic acid via the phosphoketolase pathway. This group includes *Lb. casei*, which is not usually found in starter cultures but is associated with beneficial secondary fermentation during cheese ripening.

Obligately heterofermentative lactobacilli ferment hexose sugars to lactic acid, acetic acid (or ethanol), and carbon dioxide using the phosphoketolase pathway. Pentose sugars are also fermented using this pathway. These lactobacilli can cause undesirable flavor and gas formation during ripening of cheese. They produce proteinases, endopeptidases, aminopeptidases, dipeptidases, tripeptidases, and proline-specific peptidases (Law and Haandrikman, 1997). One species, *Lb. kefir*, is associated with kefir cultures.

Table 2 Characteristics of *Lactobacillus* spp. Associated with Dairy Products

Species	Products	Growth		Lactic acid isomer	Mole %G+C	Fermentation of					
		at 15°C	at 45°C			Glu	Gal	Lac	Mal	Suc	Rib
Homofermentative											
<i>L. delbrueckii</i> subsp. <i>bulgaricus</i>	Yogurt, koumiss, kefir, Italian and Swiss cheeses	–	+	D	49–51	+	–	+	–	–	–
subsp. <i>lactis</i>	Hard cheese	–	+	D	49–51	+	d ^a	+	+	+	–
<i>L. acidophilus</i>	Acidophilus milk, laban	–	+	DL	34–37	+	+	+	+	+	–
<i>L. helveticus</i>	Yogurt, Swiss cheese	–	+	DL	38–40	+	+	+	d	–	–
Facultatively heterofermentative											
<i>L. casei</i> subsp. <i>casei</i>	Hard cheese	+	–	L	45–47	+	+	d	+	+	+
Obligately heterofermentative											
<i>L. kefir</i>	Kefir	+	–	DL	41–42	+	–	+	+	–	+

^aSome strains are positive.

Source: Cogan, 1996.

Lactobacilli are the most acid tolerant of the lactic acid bacteria, preferring to initiate growth at acidic pH (5.5–6.2) and lowering the pH of milk to below 4.0. Lactobacilli are slow to grow in milk in pure culture. For this reason, they are generally used in combination with *S. thermophilus*.

5. Propionibacteria

Propionibacterium spp. are non-spore-forming, pleomorphic, gram-positive rods that produce large amounts of propionic and acetic acid and carbon dioxide from sugars and lactic acid. They are anaerobic to aerotolerant mesophils. They are not considered to belong to the lactic acid bacteria, but are closely related to coryneform bacteria in the Actinomycetaceae group. Four species of *Propionibacterium* are found in cheese (Table 3), but *P. freudenreichii* subsp. *freudenreichii* and *P. freudenreichii* subsp. *shermanii* are most often used in cheese manufacture (Lyon and Glatz, 1995). Although *Propionibacterium* spp. are found in raw milk, they may be present in insufficient numbers to produce an adequate fermentation, so they are often added along with the lactic culture when cheese with eyes is made.

Propionibacteria can use both inorganic and organic nitrogen sources, and their requirements for amino acids vary. Most strains require biotin. Cultures for cheese manufacture are grown on complex media, including hydrolyzed protein and yeast extract with lactic acid as a carbon source (Glatz, 1992).

Propionibacteria grow on lactic acid produced during cheese fermentation. Lactate is oxidized to pyruvate, which then is either converted to acetate and carbon dioxide or propionate. Carbon dioxide forms the large eyes found in Swiss and similar types of cheese, and other metabolic products, including amino acids and fatty acids, contribute to flavor of these cheeses.

Table 3 Differentiation of *Propionibacterium* spp. Associated with Dairy Products

Characteristic	<i>Pr. freudenreichii</i>	<i>Pr. jensenii</i>	<i>Pr. thoenii</i>	<i>Pr. acidipropionici</i>
Acid from				
Sucrose	–	+	+	+
Maltose	–	+	+	+
Mannitol	–	+	–	+
Rhamnose	–	–	–	+
Nitrate reduction	–	–	–	+
β-hemolysis	–	–	+	–
Colony color	Cream	Cream	Red-brown	Cream to orange-yellow

Source: Cummins and Johnson, 1984.

6. Brevibacterium

Brevibacterium cells are aerobic, gram-positive, pleomorphic rods that grow on the surface of surface-ripened varieties of cheese. The species most often isolated from these cheeses is *B. linens*. *B. linens* produces a yellow-orange carotenoid pigment that colors the surface of the cheese. Color formation is enhanced by exposure to light. Older cultures are primarily coccoid, but slender rods are produced in exponential growth. *B. linens* does not use lactose or citrate but can grow on the lactate produced during cheese manufacture. It also grows best at neutral pH, so it does not grow well on the cheese surface until lactic acid is neutralized or metabolized by yeasts or micrococci. Surface-ripened cheeses are surface salted, and *B. linens*, like yeasts and micrococci, grows well at high salt concentrations. *B. linens* is highly proteolytic with the ability to degrade whey proteins and casein (Fringa et al., 1993; Holtz and Kunz, 1994). The ability of *B. linens* to degrade amino acids to ammonia and methionine to methanethiol is partially responsible for production of strong flavors and odors during surface ripening of cheese. Other volatile compounds produced by *B. linens* that contribute to the typical flavor of surface-ripened cheese include butyric acid, caproic acid, phenylmethanol, dimethyldisulfide, and dimethyltrisulfide (Jollivet et al., 1992). *B. linens* grows well in media containing hydrolyzed protein, glucose, yeast extract, potassium phosphate, and magnesium sulfate (Haysahi et al., 1990).

7. Enterococci

The genus *Enterococcus* includes the Lancefield group D (fecal) streptococci, *Streptococcus faecalis* and *S. faecium*, as *Ent. faecalis* and *Ent. faecium*. Since reestablishing the genus in 1984, 9 species has been transferred from the genus *Streptococcus* and 10 new species have been added (Stiles and Holzapfel, 1997; Klein et al., 1998). They are gram-positive, catalase-negative cocci, produce L(+) lactic acid homofermentatively from glucose, and also derive energy from degradation of amino acids. They have a phosphoenolpyruvate phosphotransferase (PEP-PTS) system for uptake of lactose and other carbohydrates, including gluconate.

Enterococci are used as food safety indicators and have a possible involvement in foodborne illness. Enterococci are also used as starter cultures in some southern European cheeses. In addition, they are commercially available as probiotics for prevention and treatment of intestinal disorders. Among enterococci only *Ent. faecalis* and *Ent. faecium* are important as probiotics. They are readily differentiated by fermentation of arabinose and sorbitol and by their growth temperatures (Klein et al., 1998).

8. Bifidobacteria

The genus *Bifidobacterium* is in the family Actinomycetaceae. Bifidobacteria produce lactic and acetic acids in the ratio of 2:3. They have the enzyme fructose-

6-phosphate phosphoketolase which is lacking in lactic acid bacteria. Also, the high G+C content of their DNA (55–57 mol%) and their phylogenetic relatedness place them in the actinomyces subdivision of gram-positive bacteria. The 29 species exhibit major morphological differences (Stiles and Holzapfel, 1997). The taxonomy and nomenclature of *Bifidobacterium* is still evolving, and many probiotic cultures now in use do not have the appropriate species designation. Since biochemical reactions are not always useful to classify strains isolated from dairy products, only polyphasic taxonomy, which is a combination of phenotypic and genomic traits, is able to differentiate species (Kien et al., 1998). The natural habitat of bifidobacteria is the intestinal tract. They can also be found in sewage, vaginal microflora, and dental caries. The most important species of *Bifidobacterium* for probiotic application are *B. longum*, *B. bifidum*, and *B. animalis*.

The different enzymatic capabilities of bifidobacteria strains make it difficult to select a single medium for all species (Marshall and Tamime, 1997). Technological selection criteria for bifidobacteria strains to be used as probiotic microorganisms include capability of growing to high cell density in inexpensive media, robust to culture concentration, and the capability of being harvested, frozen or freeze dried with cryoprotection. In addition, the culture must retain its viability and properties throughout the shelf life of the product. Medicoscientific criteria for selection include gastric transit tolerance, small intestinal transit tolerance, bile salt tolerance, liminal growth and persistence, epithelial adhesion, epithelial growth and persistence, coaggregation ability, and antimicrobial production and susceptibility (Charteris et al., 1998).

Bifidobacteria grow poorly in milk; possibly because of the lack of small peptides and free amino acids. Some strains exhibit better growth when milk is supplemented with casein hydrolysate or yeast extract. Strains reported to grow well in milk may be stimulated by naturally occurring growth factors such as specific casein derivatives or oligosaccharides (Marshall and Tamime, 1997).

Because of the possible role of bifidobacteria in stabilizing the digestive system of humans, much attention has recently been given to incorporation of this species into dairy products. In yogurt, they are usually used in combination with normal yogurt bacteria because of their slow acid production. However, postproduction acidification and the possibility that they are inhibited by antimicrobial compounds produced by *Lb. delbrueckii* subsp. *bulgaricus* could pose problems for their survival. Although many bifidobacteria are acid sensitive, some strains survive at pH values as low as 4. Variations in survival are affected by storage temperature, the initial number of bacteria, storage time, and strain tested. In cheese, bifidobacteria persist in moderately high numbers in spite of adverse salt content and storage temperature. Generally, bifidobacteria strains exhibit diverse responses to adverse conditions, so appropriate strain selection is very important.

9. *Penicillium*

Penicillium spp. are molds in the class Hyphomycetes in the division Deuteromycota. Molds in this class produce conidia directly on mycelium or on conidiophores. The conidiophores of *Penicillium* spp. arise erect from the hyphae and branch near the tip to produce a brush-like ending (Beneke and Stevenson, 1987). Two groups of *Penicillium* spp. are used in cheese manufacture, the white mold (*P. camemberti* Thom, formerly two species, *P. caseicolum* and *P. camemberti*), which grows on the surface of Camembert, Brie, and similar varieties; and the blue mold (*P. roqueforti*, formerly *P. roqueforti* var. *roqueforti*), which grows in the interior of blue-veined cheeses such as Roquefort, Gorgonzola, and Stilton. *P. camemberti* is closely related to *P. commune*, a common cheese contaminant that produces various toxins (Frisvad and Filtenborg, 1989), whereas *P. camemberti* produces only one mycotoxin, cyclopiazonic acid. *P. roqueforti* is closely related to *P. carneum* (formerly *P. roqueforti* var. *carneum*), a producer of the mycotoxin patulin, and *P. paneum* (formerly *P. roqueforti* var. *carneum*), a producer of patulin and the mycotoxin botryodiplodin (Boysen et al., 1996).

P. camemberti and *P. roqueforti* are lipolytic and proteolytic. Both produce methyl ketones and free fatty acids, but the much higher levels produced by *P. roqueforti* give blue cheeses their distinctive flavor and aroma (Kinsella and Hwang, 1976; Jollivet et al., 1993). *P. camemberti* contributes to the flavor of Camembert and Brie cheeses by producing a complex mixture of compounds, the major ones being 2-heptanone, 2-heptanol, 8-nonen-2-one, 1-octen-3-ol, 2-nonanol, phenol, butanoic acid, and methyl cinnamate (Moines et al., 1975).

C. Enumeration of Dairy Starter Cultures

Many complex media are available to cultivate different genera of lactic acid bacteria. However, only a few of them are considered to be selective. Table 4 lists media commonly used to enumerate dairy starter bacteria.

Different means are used to develop selective media which are based on biochemical characteristics (oxygen sensitivity, antibiotic resistance, acid production, fermentation patterns), and bioproducts of the enumerated species. The same medium can be used to enumerate selectively a particular species by changing the incubation temperature (M17 at 37°C for *S. thermophilus* and 25°C for *Lactococcus*) or by changing the pH (MRS at 5.5 for selective enumeration of *Lb. delbrueckii* ssp. *bulgaricus*). Some ingredients are added to inhibit growth of other species. For example, sodium azide makes Elliker agar more selective for lactic acid bacteria. Also, media used to enumerate bifidobacteria are characterized by the presence of substrates, which lowers the redox potential (cysteine, cystine, ascorbic acid), antibiotic, and/or a single carbon source to inhibit lactic acid bacteria. Vacomysin is added to a *Leuconostoc* medium to inhibit *Lactococcus* and

Table 4 Media Used for Enumeration of Dairy Starter Cultures

Microorganism	Media	References
Lactic acid bacteria	Elliker (lactic) agar	Elliker et al., 1956
<i>S. thermophilus</i>	1. M17	1. Terzaghi and Sandine, 1975
	2. <i>S. thermophilus</i> agar	2. Dave and Shah, 1996
<i>Lb. delbrueckii</i> subsp. <i>bulgaricus</i>	MRS (pH 5.5)	DeMan et al., 1960
<i>Lb. acidophilus</i>	1. MRS-salicin agar	1. Hull and Roberts, 1984
	2. MRS-sorbitol agar	2. Hull and Roberts, 1984
Bifidobacteria	1. BL-OG	1. Lim et al., 1995
	2. Bif	2. Pacher and Kniefel, 1996
<i>Leuconostoc</i> spp.	LUSM	Benkerroum et al., 1993
Yeasts and molds	OGY	Mossel et al., 1970
Enterococci	Citrate azide agar	Reinbold et al., 1953
Lactococci	M17	Terzaghi and Sandine, 1975
Propionibacteria	1. Sodium lactate agar	1. Vedamuthu and Reinbold, 1967
	2. Emmental juice-like agar	2. Savat-Brunaud et al., 1997
	3. Modified YEL	3. Savat-Brunaud et al., 1997
Differentiate between rods and cocci in yogurt starter	Yogurt lactic agar	Matalan and Sandine, 1986
Differentiate between homo- and heterofermentatives	HHD	McDonald et al., 1987
Differentiate between <i>Lb. acidophilus</i> , <i>Bifidobacterium</i> spp., <i>S. thermophilus</i> and <i>Lb. delbrueckii</i> subsp. <i>bulgaricus</i>	TPPPYPB	Ghoddusi and Robinson, 1996
Differentiate between <i>Lactococcus lactis</i> subsp.	Differential agar	Reddy et al., 1972

some *Lactobacillus* spp. On the other hand, nonselective media are required to enumerate injured cells; for example, lactobacilli that survive milk pasteurization used for cheese manufacture. Many different media were also developed to assist differentiation of species or subspecies. Differentiation is usually based on colony morphology, which is affected by the interaction between bacteria and medium.

D. Desirable Properties of Lactic Cultures

Properties desired of lactic cultures for industrial use may differ from those found in typical wild-type microorganisms. For example, most dairy fermentations require rapid acid production and the lack of off-flavor production, whereas wild-type organisms are often slow acid producers and produce such off-flavors as fruity, bitter, and malty. Buchenhüskes (1993) summarized selection criteria for lactic acid bacteria to be used for food fermentations. These include (1) lack of pathogenic or toxic activity (e.g., production of biogenic amines), (2) ability to produce desired changes, (3) ability to dominate competitive microflora, (4) ease of propagation, (5) ease of preservation, and (6) stability of desirable properties during culturing and storage. Specific properties desired in a dairy starter culture depend on the product being produced.

1. Cheddar Cheese

The four main selective criteria for Cheddar cheese cultures are rapid acid production, bacteriophage resistance (see Sec. V), salt sensitivity, and ripening activity (Strauss, 1997). Rapid acid production should occur at a steady rate throughout curd making. This ensures suppression of undesirable microflora, timely cheese manufacture, and the presence of sufficient ripening enzymes from starter microorganisms. Rapid lactose fermentation in lactococci is associated with the presence of a phosphoenol pyruvate-dependent phosphotransferase system (see Chap. 7 for discussion of acid production).

In Cheddar manufacture, salt is added after most of the desired acidity has developed. However, some acid-producing activity is still needed after salting to ensure that all lactose is metabolized. Residual lactose can serve as a substrate for salt-tolerant organisms such as heterofermentative lactobacilli that produce gas and undesirable flavors (Olson, 1990). Growth of starter microflora after salt addition also produces a low oxidation-reduction potential that has a beneficial impact on flavor development and inhibits some spoilage microorganisms.

Ripening activity is related to production of proteases and other enzymes. These enzymes must be produced in sufficient quantity to develop the typical Cheddar flavor without off-flavors. Peptidase activity is more important than proteinase activity. In fact, starter culture proteinases are associated with development of a bitter flavor (Visser et al., 1983). Cheese made using 45–75% proteinase-negative cells developed less bitter flavor than cheese made using

proteinase-positive cultures (Mills and Thomas, 1980). However, proteinase-negative strains cannot use proteins, so their growth in milk is limited. Starter culture peptidases hydrolyze peptides (including those with bitter flavor) produced by the action of rennet, and, in combination with other microbial enzymes, produce a chemical environment conducive to development of the typical Cheddar flavor. Starter cultures for Cheddar cheese can include strains that specifically enhance ripening but take little or no part in initial acid production (Trepanier et al., 1991). (See Chapter 7 for additional information on starter culture protease systems.)

2. Mozzarella Cheese

Cultures for mozzarella cheese manufacture are combinations of *S. thermophilus* and either *Lb. delbrueckii* subsp. *bulgaricus* or *Lb. helveticus*. American-style mozzarella is manufactured for use as a food ingredient, especially on pizza. The starter culture contributes to functional properties related to this use, such as stretchability and heat-induced browning. The typical starter culture for American mozzarella manufacture has a 1:5 rod to coccus ratio (McCoy, 1997). This results in rapid initial acid production (by the streptococci) and shortens make time. Lactobacilli produce acid late in manufacture, and are much more proteolytic than streptococci. Proteolysis during storage increases meltability and decreases stretchability of cheese (Oberg et al., 1991a, 1991b). Rod to coccus ratio only slightly influences textural changes during storage (Yun et al., 1995); level of initial inoculum has a greater influence on texture.

Hassan and Frank, (1997) found that capsule-forming nonropy lactic cultures can mimic some of the physical properties of fat in cheese curd. When used as starter cultures, the capsule-forming strains significantly increased water retention by low-fat mozzarella cheese (Perry et al., 1997, 1998).

Starter culture also affects color development during cooking. Many thermophilic cultures use only the glucose portion of the lactose molecule, excreting galactose (see Chap. 7). High-browning cheeses contain nearly five times more galactose than low-browning cheeses (Matzdorf et al., 1994). If low-browning cheese is desired, galactose-utilizing cultures such as *Lb. helveticus* can be used. Using *Lb. helveticus* instead of *Lb. delbrueckii* subsp. *bulgaricus* results in mozzarella cheese with lower galactose levels, improved melting, and decreased make time (Oberg et al., 1991a). Excessive heat during stretching (curd temperature >66°C) can inactivate starter culture enzymes and reduce galactose metabolism and proteolysis during storage (Chen et al., 1994).

3. Swiss Cheese

Starter cultures for Swiss cheese manufacture must survive the high temperatures used in its manufacture (50–52°C). The starter culture is also responsible for development of the typical Swiss cheese flavor and eye formation. The typical

Swiss cheese starter culture consists of *S. thermophilus*, *Lb. helveticus*, and *P. freudenreichii* subsp. *shermanii*. Mesophilic lactococci are sometimes added to increase acid production early in manufacture. A consistent rate of acid production by the starter is important, because more rapid acid production results in lower moisture content (Turner et al., 1983). Lactose fermentation occurs primarily during the first 24 h of manufacture. Streptococci initially predominate, using lactose and excreting galactose. Subsequent growth of lactobacilli is required for complete utilization of galactose (Hutkins et al., 1986). If all residual sugars are not used, defects from growth of gas-forming microorganisms or brown pigment formation can occur (Harrits and McCoy, 1997).

Propionibacteria grow on lactate produced by the lactic culture, converting it to carbon dioxide, propionic acid, acetic acid, and small amounts of other compounds. Propionibacteria can reach 10^9 cfu/g and use more than 50% of the lactate at the center of the cheese (Fryer and Peberdy, 1977). Swiss cheese is ripened at 21°C for eye formation and then aged at 10°C for flavor development. Therefore, the *Propionibacterium* culture should grow well at 21°C but not at 10°C (so the eyes do not split) (Harrits and McCoy, 1997). A predictable rate of gas formation at 21°C is required, because too rapid gas formation results in split eyes (Hettinga et al., 1974).

High-moisture baby Swiss is manufactured using lower cooking temperatures (approximately 40°C) and therefore is produced, not with thermophilic cultures, but with heat-tolerant lactococci. Propionibacteria are still used for eye formation.

4. Cultured Buttermilk and Sour Cream

Cultures for buttermilk, sour cream, and similar products must both acidify the substrate and produce flavor and aroma compounds. Citrate-fermenting bacteria such as *Leuc. mesenteroides* subsp. *cremoris* or *Lc. lactis* subsp. *lactis* var. *diacetylactis* are combined with *Lc. lactis* subsp. *lactis* or *Lc. lactis* subsp. *cremoris*. Citrate fermentation is discussed in Chapter 7. Diacetyl, the major aromatic compound in these products, can be reduced to acetoin by diacetyl reductase. Cultures should be selected that are low in diacetyl reductase activity. Acetaldehyde is often produced during fermentation, giving the product an undesirable “green apple” or yogurt flavor. *Leuconostocs* (but not lactococci) can metabolize acetaldehyde to ethanol, with a resulting flavor improvement (Peterson, 1997). Exopolysaccharide-producing starter cultures might improve the physical properties of low-fat sour cream.

5. Yogurt

a. Acidification Yogurt is made using a combination of *S. thermophilus* and *Lb. delbrueckii* subsp. *bulgaricus*. These organisms grow in a cooperative relationship resulting in rapid acidification. The presence of lactobacilli stimu-

lates growth of the more weakly proteolytic *S. thermophilus*, because lactobacilli liberate free amino acids and peptides from casein (Rajagopal and Sadine, 1990). *S. thermophilus*, in turn, stimulates growth of *Lb. delbrueckii* subsp. *bulgaricus*; possibly by removing oxygen, lowering pH, and producing formic acid and pyruvate (Radke-Mitchell and Sandine, 1984). Strains can be selected for the degree to which their growth depends on the presence of other microorganisms (Vedamuthu, 1994). Yogurt may also contain *Lb. acidophilus* or other nutritionally beneficial cultures. The most important characteristics for yogurt cultures are (1) rapid acidification, (2) production of characteristic balanced flavor, and (3) ability to produce the desired texture. As with other thermophilic rod-coccus dairy fermentations, initial acidification is from growth of *S. thermophilus* with lactobacilli growing later in the fermentation. Excessively rapid acidification can result in overacidification and a harsh flavor. Acidification of yogurt is controlled by refrigeration, but the culture may continue to acidify slowly at cold temperatures.

b. Flavor The ideal yogurt flavor is a balanced blend of acidity and acetaldehyde. This is achieved through culture selection, balance of rod to coccus ratio, and fermentation control. The main source of acetaldehyde is from conversion of threonine to acetaldehyde catalyzed by threonine aldolase of *Lb. delbrueckii* subsp. *bulgaricus* (Hickey et al., 1983). Lactobacilli, such as *Lb. acidophilus*, which produces alcohol dehydrogenase, convert acetaldehyde to ethanol (Marshall and Cole, 1983). Therefore, yogurt produced with *Lb. acidophilus* does not have a typical yogurt flavor. In addition to acetaldehyde, yogurt cultures produce diacetyl, acetoin, acetone, ethanol, and butanone-2 (Beshkova et al., 1998). Volatile saturated free fatty acids such as acetic, butyric, and capric may also contribute to the flavor of yogurt. Although yogurt cultures are considered to be weakly proteolytic, they cause significant proteolysis in yogurt (Tamime and Deeth, 1980) which can lead to the development of bitterness.

c. Texture The texture of yogurt results from a complex interaction between milk proteins, acid, and exocellular polysaccharide produced by the starter culture. Important physical properties include firmness, smoothness, viscosity, and gel stability (susceptibility to syneresis). The starter culture can influence each of these properties by production of exopolysaccharides.

Yogurt cultures produce exopolysaccharide in a ropy or capsular form (Ariga et al., 1992). Capsular polysaccharides are formed as a discrete structure surrounding the cell (Fig. 1A) with no apparent interaction with casein (Hassan et al., 1995a, 1995b). Ropy polysaccharides are produced as filaments that are not visualized as discrete structures by light microscopy. Hassan et al. (1996a) classified yogurt cultures into three types: those that do not produce exopolysaccharide, those that produce capsular polysaccharide, and those that produce both capsular and ropy polysaccharide. Cultures that produce only ropy polysaccharide may exist, but an extensive survey has not been reported.

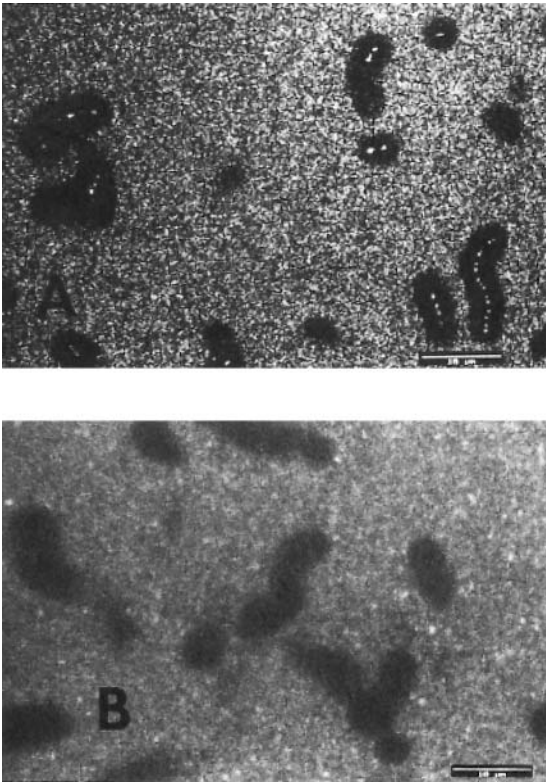

Figure 1 Confocal scanning laser micrographs of encapsulated *S. thermophilus*. (A) Encapsulated cells in milk visualized using reflected light. (B) pH gradient surrounding encapsulated cells in milk visualized using a pH-sensitive fluorochrome. Dark areas indicate low pH.

Yogurt cultures produce heteropolysaccharides that consist of different sugar residues in a repeating pattern. Their production does not depend on the presence of a specific substrate. In contrast, homopolysaccharides, such as dextran produced by *Leuc. mesenteroides*, consist of one sugar residue type (in this instance, glucose), and a specific substrate is required for their production (in this instance, sucrose). Cerning et al. (1986) found that the heteropolysaccharide produced by *Lb. delbrueckii* subsp. *bulgaricus* comprised primarily galactose, glucose, and rhamnose in a molar ratio of 4:1:1. On the other hand, *S. thermophilus* capsules are composed of D-galactose, L-rhamnose, and L-fucose in a ratio of 5:2:1 (Low et al., 1998). Garcia-Garibay and Marshall (1991) found evidence that this exopolysaccharide is closely associated with protein and may be better

classified as a glycoprotein. The exopolysaccharide of *S. thermophilus* is composed mainly of galactose and glucose with a small amount of other sugars (Cerning et al., 1988). Cerning (1990) stated that there is little agreement as to the precise composition of these polysaccharides.

The influence of ropy polysaccharide on yogurt texture is well documented, but reported effects must be interpreted with caution, because nonropy cultures used as controls were not examined for capsule production until recently. There is general agreement that ropy cultures can benefit yogurt texture by increasing viscosity and gel stability (Cerning, 1990).

However, overproduction of ropy polysaccharide yields a product with an undesirable slippery mouth feel and pronounced ropiness. Capsular polysaccharide cannot be overproduced, because capsule size is limited (Hassan et al., 1995a). Bacterial capsules disrupt the yogurt gel microstructure, producing a softer texture (Hassan et al., 1995b). Encapsulated cultures with no ropy characteristic produce yogurt that is more viscous, structurally more stable, and less susceptible to syneresis than do cultures that do not produce capsules (Hassan et al., 1996a, 1996b). The capsule also slows diffusion of lactic acid away from the cell, causing the cells to stop acid production sooner (Hassan et al., 1995a). This helps prevent overacidification of the yogurt. The pH gradient resulting from encapsulation can be visualized using confocal scanning laser microscopy, as shown in Figure 1B.

III. STARTER CULTURE PROPAGATION

A. Growth Media

The objective of starter culture propagation is to attain a preparation of active cells at high density so that fermentation is initiated as rapidly as possible. Providing adequate nutrients and controlling pH and incubation temperature are necessary to achieve this objective. Even though milk and whey are traditional growth media for lactic cultures, they provide neither optimal nutrition nor needed pH control. Consequently, various media formulations and culture growth systems have been devised to improve on traditional culture propagation.

1. Nutritional Requirements of Lactic Acid Bacteria

Lactic acid bacteria cannot synthesize various vitamins and amino acids. Lactococci require niacin, pantothenic acid, pyridoxine, and biotin for growth. *S. thermophilus* requires these vitamins plus nitroflavin, whereas lactobacilli require pantothenic acid, niacin, and nitroflavin, with some species also requiring cobalamin (Mäyrä-Mäkinen and Bigret, 1993). In regard to amino acids, lactococci and *S. thermophilus* cannot synthesize the needed branched chain amino acids (isoleucine, leucine, valine) or histidine; some strains also require arginine and methionine (Monnet et al., 1996). Lactobacilli require these amino acids in addi-

tion to several others. *Leuconostoc* spp. require valine and glutamate, and some species may have additional requirements. The presence of amino acids other than those required often stimulates growth. Although milk contains many of the essential amino acids for starter culture microorganisms, these are not present in sufficient quantity to sustain maximal growth rates (Monnet et al., 1996). Lactic acid bacteria with greater proteolytic ability have less need for amino acid supplementation of milk-based growth media.

2. Growth Media Formulations

Ingredients commonly used to formulate starter culture media have been described by Whitehead et al. (1993) and are presented in Table 5. Lactose is always used as the major carbohydrate, although low concentrations of maltose, sucrose, or glucose are sometimes added to stimulate growth (Sandine, 1996). Yeast extract is a source of nitrogen as well as a supplier of vitamins, minerals, and other growth stimulants. Casein hydrolysates are added to provide readily available amino acids. Also, addition of whey protein concentrate to whey or UF (ultra filtered) whey permeate broth stimulates growth of lactic acid bacteria (Bury et al., 1998). Heat-stable α -nucleotide, nonprotein nitrogen, or some peptidases could be responsible for this stimulatory effect (Bury et al., 1998). Corn steep liquor, although a good source of vitamins, is not often used, because its supply is limited (Sandine, 1996). Sandine (1996) questioned the need for added antioxidants in media formulations, because acceptable growth can often be achieved in their absence. Neutralizers, such as ammonium or potassium hydroxide, help prevent excessive acidity. Phosphates are commonly used in culture media, because they act both as acid-neutralizing and phage-inhibitory agents.

3. Phage-Inhibitory Media

One of the first improvements in whey- and milk-based culture media was development of phage-inhibitory media (see Sec. V).

B. pH Control During Culture Propagation

Although lactobacilli grow best under slightly acidic conditions, other starter culture microorganisms prefer conditions near neutrality. For example, the optimal pH for growth of *S. thermophilus* is 6.5, whereas for *Lb. delbrueckii* subsp. *bulgaricus*, it is 5.8 (Beal et al., 1989). The optimal pH for growth of lactococci ranges from 6.0 to 6.5 (Mäyrä-Mäkinen and Bigret, 1993). As the pH decreases below the optimal range, growth slows, and as the pH continues to decrease, cells become susceptible to sublethal acid injury and gradually lose their activity. The greater the loss of activity, the longer the ripening time required before rennet addition when making Cheddar cheese. Therefore, maintaining the pH of culture

Table 5 Ingredients Used in Formulating Bulk Starter Media for Lactic Acid Bacteria

Carbohydrate	Nitrogen source	Vitamins and minerals	Phage-inhibitory agents	Antioxidants	Neutralizers
Lactose	Milk protein	Yeast extract	Phosphates	Ascorbic acid	Carbonates
Maltose	Whey protein	Corn steep liquor	Citrates	FeSO ₄	Phosphates
Sucrose	Hydrolyzed casein				Hydroxides
Glucose					Oxides

Source: Whitehead et al., 1993.

media high enough to avoid acid injury is critical for producing cultures that consistently have sufficient activity for timely cheese manufacture. Acid injury in lactococci occurs when the pH declines below 5 (Harvey, 1965). Limited pH control can be achieved by addition of buffers to culture media. Buffering agents, such as phosphates and carbonate, allow development of higher cell concentrations, because the pH of the medium stays above 5 for a longer time. However, the neutralizing ability of the buffering agent is eventually overcome, exposing cells to excessive acidity. Also, high concentrations of buffers inhibit growth of some starter strains. Two approaches, internal and external pH control, are currently used to maintain growth media above pH 5 during culture preparation.

1. External pH Control

External pH control refers to a culture preparation system in which neutralizing agent is added to the medium during fermentation either manually or mechanically. There may be one or multiple additions of neutralizer. For one-step control, the pH of the medium is allowed to decrease to approximately 5, after which, sodium or potassium hydroxide is added to obtain a pH of 6.5–7 (Limsowtin et al., 1980). The culture is then allowed to incubate an additional 2 h before cooling. Multiple-step neutralization uses a mechanical system consisting of a pH electrode mounted in the bottom of the culture tank, a pump for adding ammonia to the tank, and a controller. When the pH declines below 5.8–6.2, the controller activates the pump to add ammonia until the pH is raised a certain amount (usually to 6–6.2). When acid production ceases because of lactose limitation, the culture is cooled (Thunell, 1988). External pH control has an additional advantage of requiring less phosphate for phage inhibition, because calcium is less soluble at higher pH. A disadvantage of external pH control is that the higher pH allows growth of nonstarter microflora even after lactose is depleted (Thunell, 1988). Therefore, a high degree of sanitation is required to implement this system. External pH control systems produce starter culture with 10 times greater cell concentration than phosphate-buffered media (Thunell, 1988). These cells are also healthier (i.e., they have no acid injury). The result is that a lower volume of starter can be used and milk ripening times are reduced. In addition, the culture produces acid more rapidly after salting (for Cheddar manufacture). More culture strains produce acceptable activity during cheese manufacture when external pH control is used for culture propagation as compared with conventional buffered media (Thunell, 1988).

2. Internal pH Control

Internal pH control describes a culture production system in which an insoluble neutralizing agent is added to the culture medium. The neutralizing agent is released in response to acid production. One means of achieving internal pH control

is to use sodium carbonate encapsulated in magnesium stearate (Whitehead et al., 1993). Magnesium stearate dissolves at pH 5.2–5.3, releasing sodium carbonate. A similar effect is obtained by using buffer salts that are insoluble above a pH of 5.2 (Mermelstein, 1982). Sandine (1996) considered trimagnesium phosphate to be the most effective agent for this purpose. Internal pH control media have similar advantages to external pH control systems. In addition, a mechanism for adding neutralizing compound to the medium does not need to be installed. However, the fermentation tank must be stirred to keep the insoluble neutralizing agent suspended during fermentation. Agitation may lead to incorporation of sufficient oxygen into the medium to stimulate hydrogen peroxide production, resulting in autoinhibition of the culture (Mäyrä-Mäkinen and Bigret, 1993).

C. Incubation Conditions

Incubation temperature can affect activity and strain balance of the starter culture. Mesophilic cultures are grown at 21°C if growth of leuconostocs is desired; otherwise, higher temperatures (up to 27°C) are used (McCoy and Leach, 1997). Incubation at 26°C helps maintain strain balance (Collins, 1976). Incubation is usually for 14–16 h or until a pH of 5 is reached. If pH control is not used, the final pH should be 4.8. Thermophilic cultures are incubated from 30 to 46°C for 8–10 h. A final pH value as low as 4.7 is acceptable, but this favors growth of lactobacilli (McCoy and Leach, 1997). Lower incubation temperatures favor growth of *S. thermophilus* and higher temperatures favor lactobacilli. Once the target pH is reached, the culture is cooled. Most cultures continue to produce acid during cooling. Mesophilic starters should be cooled to 5 to 7°C and thermophilic cultures to below 12°C (McCoy and Leach, 1997).

IV. COMMERCIAL STARTER CULTURE PREPARATIONS

Manufacturers of cultured dairy foods have several options for meeting their culture needs. The simplest (and usually most expensive) is to purchase frozen concentrated cultures that can be used to inoculate directly milk from which product will be manufactured. Using these “direct-to-vat” or “direct-vat-set” cultures avoids the possibility that starter culture will become contaminated with phage during preparation within the plant. Also, appropriate strain balance is assured. Alternatively, culture can be prepared at the plant. This culture, called bulk culture, can be prepared from commercially available frozen concentrated or freeze-dried cultures, or the inoculum can be prepared at the plant. Preparing inoculum at the plant involves starting with a “mother” culture maintained in small amounts (approximately 100 mL) of medium. The mother culture is used to inoculate successively larger amounts of medium (using a 1% inoculum) until

sufficient inoculum volume is obtained to prepare the bulk culture. Preparing bulk culture inoculum at the plant carries an increased risk of phage contamination, so most plants purchase an inoculum either as a frozen concentrated or freeze-dried preparation. A new process for continuous production of mixed-strain lactic starter cultures employs immobilized cells in supplemented whey permeate medium. The advantages of this process are increased acid production and maintenance of strain balance (Lambboley et al. 1997; Sodini et al., 1998).

A. Frozen Concentrated Cultures

Frozen concentrated cultures contain 10^{10} – 10^{11} cfu/g, a sufficient concentration to allow 70 mL to inoculate 1000 L of medium for bulk culture preparation (Sandine, 1996). Preparation of frozen concentrated cultures involves (1) growing cultures under optimal conditions using pH control, (2) harvesting the cells via centrifugation or ultrafiltration, (3) standardizing the cell suspension to a specific activity, (4) adding a cryoprotectant, (5) packaging, and (6) rapid freezing using liquid nitrogen. The pH of the cell concentrate should be 6.6 for lactococci and 5.4–5.8 for lactobacilli (Stadhouders et al., 1971). There are many cryoprotective agents that can be used, including glycerol, monosodium glutamate, sucrose, and lactose (Mäyrä-Mäkinen and Bigret, 1993). Rapid freezing can also be accomplished using a dry ice–alcohol mixture (Sandine, 1996). The frozen concentrate should be stored at -196°C (liquid nitrogen) for best retention of activity, although storage at -40°C (dry ice) is also acceptable. Rapid thawing minimizes cell injury. This is accomplished by immersing the unopened can of cell concentrate in cool chlorinated water immediately before use.

B. Freeze-Dried Cultures

When transportation and storage of cultures at -40°C is not possible, freeze-dried cultures are a good alternative to frozen concentrates. Current technology can provide highly active freeze-dried cultures that, like some frozen concentrated cultures, can be added directly to milk in the cheese vat. The major disadvantage of using freeze-dried preparations in this manner is the longer lag phase they exhibit, adding an additional 30–60 min to the time required to make Cheddar cheese (Sandine, 1996). Freeze drying reduces the ability of a culture to utilize exogenous but not endogenous carbohydrates (Riis et al., 1995). Preparation of freeze-dried cultures is initially similar to that of frozen concentrates. After freezing, the culture concentrate is placed under high vacuum to dehydrate by sublimation. Usually 60–70% of the cells that survived freezing will survive the dehydration step of the freeze drying (To and Etzel., 1997). The dry cells are then packaged under aseptic conditions, preferably in the absence of oxygen. Exposure to oxygen rapidly damages the cells (Yang and Sandine, 1979).

C. Spray-Dried Cultures

Survival of cultures after spray drying is usually much lower than after freeze drying, because cells are simultaneously exposed to both thermal and dehydration stresses. The viability of spray-dried cultures depends on many factors including, growth conditions, age of culture, cell paste loading, processing, rehydration conditions, and cryoprotective used (Champagne et al., 1991).

V. BACTERIOPHAGES

Bacteriophages (phages) are viruses that infect bacteria. Bacteriophagic infection of starter cultures can result in failure of the fermentation and loss of product. Whitehead and Cox (1935) first recognized bacteriophagic infection as a cause of failure of single-strain starter cultures used for Cheddar cheese production. Excellent conditions for development of bacteriophages were created in the 1950s when cheese production increased, resulting in more intensive use of facilities and preparation of larger amounts of lactic cultures (Huggins, 1984). Despite implementation of control measures, bacteriophagic infection still causes production problems in the modern dairy fermentation industry. Adoption of control strategies based on the use of lactic acid bacteria genetically engineered for bacteriophagic resistance should provide substantial improvements in dependability of starter cultures (Dinsmore and Klaenhammer, 1995).

A. Characteristics of Bacteriophages

1. Morphology/Taxonomy

Bacteriophages that infect lactic acid bacteria usually consist of a head and tail section. The head can be either isometric or prolate (Fig. 2). An isometric head consists of 20 equal-size proteins that form an icosohedron. A prolate head has elongated side units. Phage DNA is enclosed by head proteins. Phages attach to the host by their tail sections, through which DNA passes into bacteria. Tail sections are of variable length and may have collars, sheaths, and base plates. Base plates can be seen at the end of the tail of the phage illustrated in Fig. 3.

Bacteriophages of lactic acid bacteria can be classified by morphology, serology, and DNA-DNA homology. These classification criteria generally produce consistent groupings (Lodics and Steenson, 1993). Six morphological types of lactic phages are commonly encountered. These include small isometric, collared small isometric, short-tailed small isometric, long-tailed small isometric, large isometric, and prolate (Lodics and Steenson, 1993). Each morphological type may include several distinct genotypes of which there are 12 (Neve, 1996).

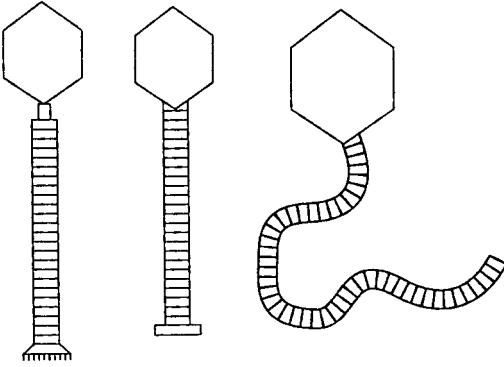

A

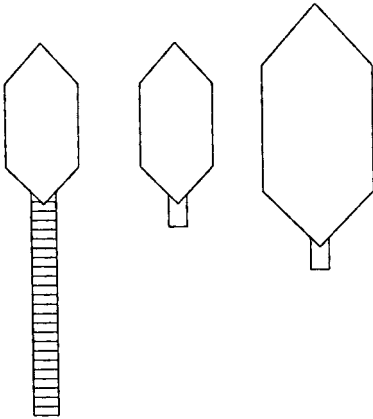

B

Figure 2 Morphology of common bacteriophages of lactic acid bacteria. (A) Isometric phage with long tails. (B) Prolate phage with short and long tails.



Figure 3 Electron micrograph of isometric phage of *Lactococcus lactis*. (From Moineau et al., 1994).

Bacteriophages of *S. thermophilus* form one homologous grouping as opposed to bacteriophages of mesophilic lactococci and *Lb. delbrueckii*, which are genetically diverse (Jarvis, 1989; Brussow et al., 1994).

2. Phage-Host Interactions

a. Host Range Host range reflects the ability of a specific bacteriophage to infect different strains of bacteria. Host range varies widely between bacteriophages. In addition, susceptibility of specific strains of lactococci to phagic attack is to some degree based on plasmid-associated resistance factors and is therefore highly variable. Bacteriophages of *Lc. lactis* subsp. *cremoris* tend to have a more limited host range than bacteriophages of *Lc. lactis* subsp. *lactis* (Jarvis, 1989). Isometric phages of lactococci tend to have limited host ranges, whereas prolate phages have broader host ranges. Some phages can attack both subspecies of *Lc. lactis* (*lactis* and *cremoris*). Several phages can attack both *Lb. delbrueckii* subsp. *bulgaricus* and *Lb. delbrueckii* subsp. *lactis* (Jarvis, 1989).

b. Lytic Cycle Bacteriophagic infections are caused by either lytic or temperate phages. Infection with lytic (virulent) phages results in release of infectious viral particles (virions) into the environment, whereas temperate phages incorporate their DNA into the host chromosome and do not immediately produce new virions. The sequence of events in the lytic cycle is described by Neve (1996)

and is illustrated in Fig. 4. Phagic infection is initiated by adsorption of the virion onto the surface of the host cell. Only bacteria with specific adsorption sites serve as hosts for the bacteriophage; the presence of these sites determines to a great extent the host range of a particular phage. Recognition of an appropriate site and adsorption to it are mediated by the base plate, spikes, or fibers at the end of the phage tail. Many phages require Ca^{2+} for adsorption.

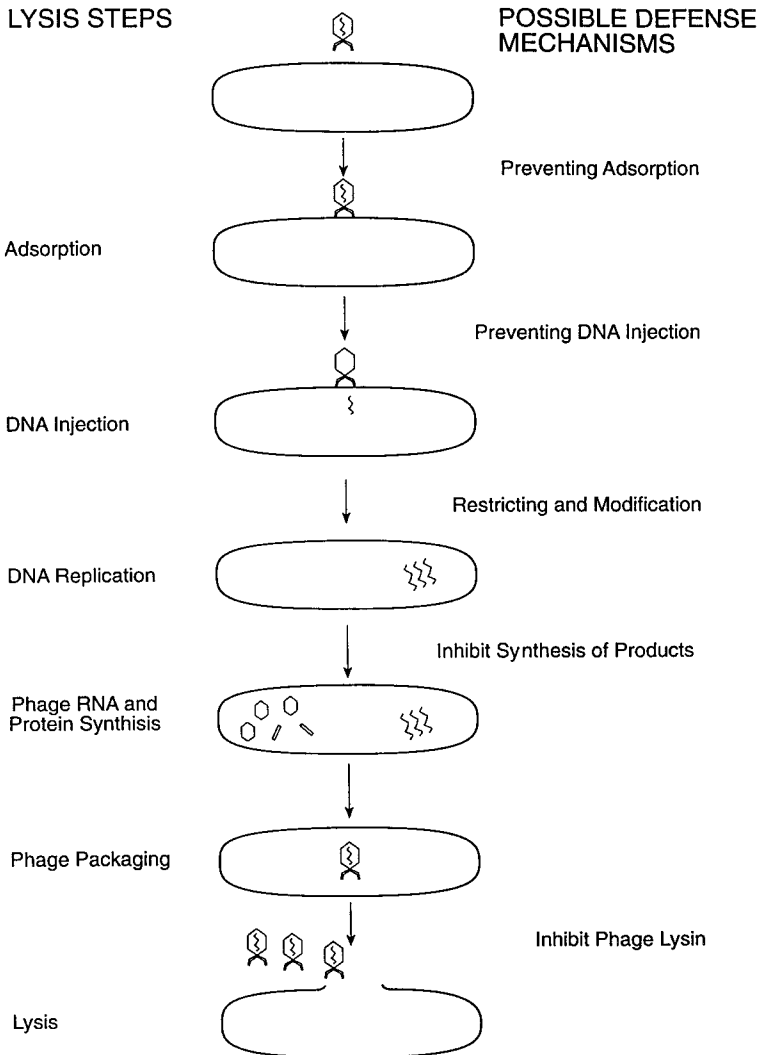

Figure 4 Stages in the lytic cycle where bacteriophage defense mechanisms are active.

After adsorption, the phage injects its DNA into the host. The DNA passes from the head through the tail into the bacterial cell while the “empty” virion remains outside. Normal metabolism of the infected cell then ceases as the host first replicates phage DNA and then phage proteins. This process, called maturation, ends with self-assembly of virions within the host cell. Initially, heads form around viral DNA followed by attachment of tails. Finally, the lytic cycle is completed when a lytic enzyme (lysins), encoded on viral DNA, is produced, resulting in cell lysis and release of infective phagic particles into the surrounding environment. Lysin released from infected cells can also lyse noninfected cells. The time from initial adsorption to release of phages is called the latent period. For lactococcal phages, this period ranges from 10 to 140 mins. The number of virulent particles released per infected cell is called the burst size. This ranges from less than 10 to more than 300 for lactococcal phages (Klaenhammer and Fitzgerald, 1994).

c. Temperate Cycle Infection with a temperate phage does not necessarily lead to immediate production of new virions. DNA of a temperate phage may instead be incorporated into the chromosome of the host cell or maintained as a plasmid within the cell (Cogan and Accolas, 1990). This DNA, referred to as a prophage, replicates with the bacterium without affecting its metabolism. The resulting condition, lysogeny, is common in lactococci (Davidson et al., 1990) and lactobacilli (Sechaud et al., 1988), rare in *S. thermophilus* (Brussow et al., 1994), and unreported in *Pediococcus*, *Leuconostoc*, and *Propionibacterium* spp. (Davidson et al., 1990). Lysogeny can be maintained indefinitely. Lysogenic bacteria are immune to the infecting and other closely related phages. They maintain the potential to produce virulent phages and can spontaneously realize this potential. Phage production can also be induced by exposing cells to ultraviolet (UV) light or mitomycin C to inactivate the repressor protein that blocks expression of growth genes (Lodics and Steenson, 1993).

The extent to which lysogenic bacteria in starter cultures pose a threat to industrial fermentations is still uncertain (Jarvis, 1989; Davidson et al., 1990). Temperate phages can mutate to become virulent, resulting in fermentation failure (Shimizu-Kodata et al., 1983), although spontaneous induction of virulent phages from lysogenic strains appears to be rare (Teuber and Lembke, 1983). Surveys of lactococcal phage DNA homology indicate that, although some lytic phages appear to be variants of temperate phages, this is generally not true (Davidson et al., 1990).

d. Pseudolysogeny Pseudolysogeny (phage carrier state) occurs when a bacterial culture carries lytic phages while maintaining an active cell population. The culture remains active, because only a portion of the total population is sensitive to the phage, with the remaining population retaining the ability to grow rapidly and produce acid. Establishment of pseudolysogeny depends on the ability of a culture to produce variants having different degrees and types of phage

sensitivity (Lodics and Steenson, 1993). Unlike true lysogeny, phages can be eliminated from a pseudolysogenous culture by growing it in the presence of phage-specific antibodies or by repeated culture purification (selection of isolated colonies on agar plates).

3. Phage Resistance Mechanisms

Phage resistance in lactic acid bacteria is based on at least four different natural mechanisms (Hill, 1993; Dinsmore and Klaenhammer, 1995; Allison and Klaenhammer, 1998): adsorption inhibition, DNA injection inhibition, DNA restriction and modification systems, and abortive infection. Stages in the lytic cycle where these mechanisms are active are illustrated in Figure 4. Many lactococci used in starter cultures exhibit one or more of these resistance mechanisms. Adsorption inhibition is the failure of phage to attach to the bacterial surface. This can result from spontaneous mutation modifying the attachment site or from a plasmid-linked factor (Dinsmore and Klaenhammer, 1995). Plasmids can encode for production of polymers that coat attachment sites, preventing phage adsorption.

DNA injection inhibition occurs when phage adsorbs to the cell surface but phage DNA stays inside the head section and fails to enter the host cell cytoplasm. This resistance mechanism appears to be rare (Dinsmore and Klaenhammer, 1995). A plasmid-encoded injection-blocking system in *Lactococcus* was first described by Garvey et al. (1996). They concluded that DNA injection inhibition resulted from an alteration in plasma membrane components of the host cell.

Phage resistance based on DNA restriction and modification enzymes (R/M) is common in lactococci. The restriction enzyme hydrolyzes phage DNA at a specific site. Host DNA is modified by methylation at this site and is therefore unaffected by the restriction enzyme. Restriction and modification enzymes are linked to the same plasmid. It is possible, but rare, for phage DNA to be methylated by the host modification system before it is hydrolyzed by the restriction enzyme. When this happens, the phage is able to cause a normal infection. Phages whose DNA does not contain the targeted restriction site are also unaffected by this resistance mechanism. Four groups of R/M can be distinguished based on their enzyme structures and cleavage characteristics (Forde and Fitzgerald, 1999).

Abortive infection is a type of phage resistance resulting in decreased production of virulent phages by infected cells but not involving restriction or modification. Abortive infection results in cell death, but because phage replication is much reduced, the phage population does not increase sufficiently to affect culture activity. Abortive infection does not induce genetic changes in the infecting phage. Numerous (at least seven) nonhomologous plasmids encode for abortive infection resistance, indicating that many different types exist (Dinsmore and Klaenhammer, 1995; Neve, 1996).

When a host cell with phage resistance is exposed to sufficiently high numbers of phages, it is possible for the phage to mutate to overcome the resistance mechanism. Also, if phage inhibition is not complete, resistant phages are selected (Hill, 1993). If phage DNA is modified by the host enzyme to become resistant to the restriction enzyme, resulting resistance is lost when the phage infects a cell that lacks the methylase enzyme. More lasting insensitivity occurs when phages mutate at the hydrolysis site of the restriction enzyme. Some lactococcal bacteriophages have evolved to have very few sites available for restriction endonuclease hydrolysis (Dinsmore and Klaenhammer, 1995). Phages also develop insensitivity to abortive injection mechanisms, apparently through point mutations.

4. Phage Survival

Many bacteriophages have good survival characteristics. Some can survive high-temperature, short-time pasteurization, so media for starter preparation are usually heated to at least 85°C for 30 mins to ensure inactivation of the phage (Neve, 1996). Phages can also survive spray drying and storage of milk powder (Chopin, 1980). Phagic particles on surfaces are readily inactivated by chlorine but not by iodine or acid sanitizers (Anonymous, 1990). Sanitizer inactivation depends on elimination of organic matter through effective cleaning.

B. Characteristics of Phagic Infection

Bacteriophages are primarily a problem in cheese manufacture. This is probably because cheese milk (as compared to cultured milks) is given only a mild heat treatment and because cheese milk and whey are often exposed to a phage-contaminated environment. Bacteriophages do not proliferate in cheese curd, because virions cannot move through the protein matrix. However, cells infected with phage before coagulation become inactivated during cheese manufacturing. Because latency periods are normally approximately 30 min (but may be much longer), a culture may initially show normal growth in cheese milk but then reduce or stop acid production during manufacture. If one culture preparation is used to inoculate a series of vats of milk, increasing numbers of phages active against this culture may develop within the manufacturing plant. The result is that acid production proceeds normally in the vats of milk inoculated initially but is delayed later in the production day.

C. Preventing Phagic Inhibition

Preventing inhibition of acid production resulting from phagic infection requires implementation of control measures throughout the manufacturing process. These

should include selection, preparation, and maintenance of cultures free of virulent phage, controlling entry of phages into the processing facility, and controlling spread of phages within the facility.

1. Phage-Inhibitory Media

Growth of phages during production of bulk starter can be controlled by using phage-inhibitory media. These media rely on the ability of phosphate and citrate salts to bind ionic calcium, thus inhibiting phagic absorption (Reiter, 1956). The chelating agents can slow growth of the starter culture. Phage-control media often contain deionized whey, protein hydrolysates, ammonium and sodium phosphate, citrate salts, and other growth stimulants such as yeast extract (Whitehead, 1993). Commercial phage-inhibitory media vary widely in their ability to prevent phage proliferation; the most effective being those that contain sufficient nutrients to overcome the inhibitory nature of the media and contain citrate buffers (Gulstrum et al., 1979). Not all bacteriophages are inhibited by the absence of calcium (Sozzi, 1972; Quiberoni and Reinheimer, 1998), so, to be effective, phage-inhibitory media should be used as only one part of an overall phage-control strategy. Proliferation of phages during starter preparation can also be avoided by using cell concentrates designed to be added directly to cheese milk in the vat or by preparing cultures under strict aseptic conditions.

2. Use of Phage-Resistant Cultures

Lactic acid bacteria vary widely in their susceptibility to bacteriophagic infection, so the use of resistant strains is an important aspect of phage control. Phage-resistant strains have been isolated from mixed-culture systems that maintain activity while carrying low levels of phages (Lodics and Steenson, 1993). Strains can also be genetically altered to contain plasmids coding for phage resistance (Klaenhammer, 1991). Phage-resistant variants can be selected by exposure to factory whey containing phages that have developed during cheese manufacture (Sandine, 1989). Resistant variants are tested for rapid acid production and added back to the starter in use in that factory. The use of such a system requires daily monitoring of whey for phages, but it allows the use of a single mixture of five or six defined strains over a long time. This approach to phage control is often used in North America and elsewhere.

Protease-negative strains of lactococci are resistant to phagic infection because of their slow growth rates (Richardson, 1984). Although more cells must be used to compensate for lack of growth during cheese manufacture, these variants offer other advantages, including lowered sensitivity to antibiotics, lowered heat sensitivity (allowing the use of higher cook temperatures), greater yield because of lowered casein solubilization, and decreased risk of bitter flavor development in cheese.

Exopolysaccharide-producing strains are more resistant to phage (Moineau et al., 1996). Phages that infect and lyse strains producing exopolysaccharide possess a polysaccharide depolymerase enzyme specific for this particular exopolysaccharide (Hughes et al. 1998).

3. Culture Rotation

Culture rotations control bacteriophagic infection by limiting the length of time that a specific strain or mixture of strains is used. Cultures following each other in the series are susceptible to different phage types and are therefore unaffected by phages that may have infected the previous culture. Cultures can be rotated on a daily basis or after each vat of milk is inoculated. Short rotations over 2–3 days using 6–12 strains and long (5–10 days) rotations of up to 30 strains are used (Huggins, 1984). However, the use of a limited number of cultures at any one time is recommended to reduce exposure to prophages and maintain product uniformity. Culture rotation does not eliminate phage growth in cheese milk in vats, but if phage numbers are kept to less than 10,000 pfu/mL of cheese whey, acid production is not affected (Huggins, 1984). Success of a culture rotation is limited by availability of phage-unrelated strains with acceptable fermentation properties. In addition, using many different cultures can result in lack of product uniformity.

A new type of culture rotation system has been developed by Sing and Klaenhammer (1993) and Durmaz and Klaenhammer (1995). This system uses genetic derivatives of a single strain, each with a different phage-resistance mechanism. When used in rotation or as mixtures, resistant phages fail to develop, because they cannot overcome the multiple resistance mechanisms. This type of rotation avoids the lack of product uniformity associated with conventional culture rotations and allows continuous use of strains with special properties.

O’ Sullivan et al. (1998) stacked three plasmids encoding distinct phage resistance mechanisms (adsorption inhibition, R/M, and Abi) in addition to the lactose proteinase plasmid to generate a host with phage resistance and acceptable fermentation characteristics. This isogenic single-strain starter rotation system in which complementary defenses are rotated within one starter limits exposure of phages to any single defense mechanism.

4. Genetically Modified Resistance Strains

Since phage-resistance plasmids are transferrable by conjugation, application of genetic engineering technology can introduce industrially significant phage-resistance starter strains (Coakley et al., 1997; Allison and Klaenhammer, 1998; O’Sullivan et al., 1998). However, the evolutionary capacity of phages which allows their genetic modules to be exchanged in addition to the presence of lyso-

genic starter cultures show the need for continuous development of novel phage-insensitive mechanisms and strains (Forde and Fitzgerald, 1999).

5. Sources of Bacteriophages in the Dairy Plant

Bacteriophages in the dairy plant probably are of farm origin, although, as discussed previously, lysogenic bacteria may also be a source. Although the major means by which a phage enters the plant is in raw milk; trucks and personnel having had contact with the farm environment could also be carriers. After monitoring a mozzarella cheese factory for 2 years, Bruttin et al. (1997) postulated a single phage invasion event and diversification of the phage during its residence in the factory. They then introduced a defined starter system that could not propagate the resident factory phage population. It is not practical to eliminate entry of phages into the dairy plant, because raw milk continually enters the facility. However, growth of phages within the plant and dissemination of phages to milk in the cheese vat can be controlled. Bovine colostrum may have antibodies that could protect *Lc. lactis* strains from phage attack (Geller et al., 1998). The main growth niches for bacteriophages in a cheese plant are raw milk, whey, spilled product, pools of water, stagnant floor drains, equipment, and soiled walls (Anonymous, 1990). Phage development in these growth niches is controlled by effective sanitation. Phages are disseminated throughout the dairy plant by aerosol and human carriers. Air entering cheese manufacturing rooms should be under positive pressure of high-efficiency particulate air (HEPA) filtered air. When preparing bulk starter, air drawn into the tank when the culture medium cools should be filter sterilized. Milk in cheese vats is most susceptible to phage contamination during ripening and setting, so these processes should be accomplished in closed systems. They should be removed to a physically separate facility, because whey processing produces aerosols that can carry phage particles. Plant personnel with exposure to whey should not be allowed access to the milk-ripening or bulk starter facilities.

VI. OTHER CULTURE INHIBITORS

A. Raw Milk–Associated Inhibitors

Lactic starter cultures grow more slowly in raw than in heated milk; a phenomenon caused by the presence of natural inhibitors. The lactoperoxidase system is the most significant microbial inhibitor in raw milk, but the presence of agglutinins is an important problem in acid-coagulated cheeses. Other naturally occurring microbial inhibitors in milk include lysozyme and lactoferrin. Mastitic milk has increased levels of microbial inhibitors and increased phagocytic activity that are part of the cow's response to infection. However, mastitic milk is also

higher in protease activity, and the resulting casein fragments can counteract inhibitor effects and even stimulate growth of weakly proteolytic lactics such as *S. thermophilus* (Marshall and Bramley, 1984; Okello-Uma and Marshall, 1986).

1. Lactoperoxidase System

Microbial inhibition by the lactoperoxidase system derives from interaction of three components: lactoperoxidase, an enzyme native to milk; thiocyanate, derived from hydrolysis of cyanogenic glucosides found in certain feeds; and hydrogen peroxide, generated by leukocytes and through oxygen metabolism of lactic acid bacteria (Limsowtin, 1992). The inhibitor, hypothiocyanite, is produced when lactoperoxidase catalyzes oxidation of thiocyanate and simultaneous reduction of hydrogen peroxide. Bovine colostrum and milk contain about 11–45 mg/L and 13–30 mg/L lactoperoxidase, respectively (Korhonen, 1977). Hydrogen peroxide is usually the limiting component in raw milk, but thiocyanate is also often present in suboptimal concentrations (Limsowtin, 1992). Lactoperoxidase is only partially inactivated by pasteurization (Wolfson and Sumner, 1993). However, more severe pasteurization temperatures (80°C for 15 s) will completely inhibit the lactoperoxidase system. This might explain why sometimes milk pasteurized at 72°C exhibits better keeping quality than that pasteurized at higher temperatures (Barrett et al., 1999). The lactic starter cultures most sensitive to lactoperoxidase inhibition are those that generate hydrogen peroxide. This includes some strains of *Lb. delbrueckii* subsp. *bulgaricus* and *Lb. acidophilus* (Guirguis and Hickey, 1987b). Other lactic acid bacteria, including *S. thermophilus* and some strains of lactococci, are sensitive to lactoperoxidase inhibition when combined with cultures that produce hydrogen peroxide. The inhibitory effects of the lactoperoxidase system can be controlled by limiting aeration of milk, avoiding the use of hydrogen peroxide-generating cultures, using cultures that degrade hydrogen peroxide, and using heat treatments more severe than pasteurization. Lactoperoxidase activity suppresses acid production in yogurt during refrigerated storage and produces product having a softer texture (Nakada, et al., 1996; Hirano et al., 1998).

2. Immunoglobulins (Agglutinins)

Bovine milk contains four types of immunoglobulins: IgG1, IgG2, IgM, and IgA at concentrations of 0.3–0.4, 0.03–0.08, 0.03–0.06, and 0.04–0.06 g/L, respectively (Pakkanen and Aalto, 1997). Lactic starter cultures can interact with immunoglobulins in milk to form aggregates or clumps. As the cells produce acid, casein coagulates around these clumps and they settle out of the milk forming a sludge (Grandison et al., 1986). Acid production is inhibited, because diffusion of acid out of the sludge is limited, causing acid inhibition of the culture before the milk is properly acidified (Hicks and Ibrahim, 1992). This type of inhibition

is of significance when acid coagulation is desired, as for cottage cheese, which exhibits a loss of curd. Culture agglutination can be reduced by selecting agglutination-resistant cultures, using whey-based culture media with agglutinins removed by protease treatment (Ustunol and Hicks, 1994), homogenization of milk before culturing (Hicks and Hamzah, 1992), and homogenization of the starter culture (Hicks et al., 1998). Susceptibility of starter cultures to bind milk immunoglobulins can be determined by using an enzyme-linked immunosorbent assay (ELISA) (Ustunol and Sypien, 1996).

3. Lysozyme

Lysozyme inactivates bacteria by cleaving the glycosidic bond between *N*-acetylmuramic acid and *N*-acetylglucosamine in the peptidoglycan of the cell wall. Gram-positive bacteria are highly susceptible to lysozyme activity because of the high peptidoglycan content of their cell wall and a lack of protective lipopolysaccharide. Bovine milk contains only approximately 0.07–0.6 mg/L (Korhonen, 1977).

4. Lactoferrin

Lactoferrin is an iron-binding protein that inhibits bacteria by denying their access to iron. Cow's milk contains only 20–200 µg/mL of lactoferrin (Masson and Heremans, 1971), and its activity is limited because it competes with citrate for binding iron (Batish et al., 1988). Inhibition of starter cultures by lactoferrin is unlikely to be significant.

B. Antibiotics

Treatment of mastitis in cows involves application of antibiotics. Milk from treated cows cannot be legally sold, but, occasionally, it becomes mixed with salable product. The resulting low-level antibiotic contamination may be sufficient to inhibit starter culture microorganisms. As antibiotic levels in milk increase, acid production decreases. Lactic acid bacteria are very sensitive to antibiotics commonly used for mastitis treatment. These include penicillin, cloxacillin, streptomycin, and tetracycline. Milk that tests negative for antibiotics, using *Bacillus stearothermophilus* as an indicator, can still have sufficient antibiotic to cause starter culture inhibition (Valladao and Sandine, 1994a). When antibiotics other than penicillin are present, available methods may not be sufficiently sensitive to detect residues that could cause a 20% reduction in lactic acid production (Schiffmann et al., 1992).

Sensitivity of starter cultures to antibiotics is highly strain and species dependent. *S. thermophilus* is more susceptible to penicillin and cloxacillin (β -lac-

tam antibiotics) than are the lactococci, but lactococci are more sensitive to streptomycin and tetracycline (Desmazeaud, 1996). Swiss (Emmenthal) cheese made with antibiotic-contaminated milk (0.005 IU/mL) exhibited abnormal eye formation, presumably from inhibition of propionibacteria (Mäyrä-Mäkinen and Migret, 1993).

C. Chemical Sanitizers

Occasionally, chemical sanitizers may contaminate milk, usually as a result of human error. Chlorine- and iodine-based sanitizers lose their activity in milk and are, therefore, unlikely to cause starter culture inhibition. Quaternary ammonium compounds present more potential problems, because they maintain activity in milk, and lactic acid bacteria are sensitive to low concentrations. Valladao and Sandine (1994b) observed that all tested *Lactococcus* strains were inhibited by 20 µg/mL and some were inhibited by only 10 µg/mL quaternary ammonium compound. Thermophilic starter cultures are inhibited at 0.5–2.0 µg/mL quaternary ammonium compound (Guirguis and Hickey, 1987a).

Peracetic acid and acid anionic sanitizers can also maintain some activity in milk (Dunsmore, 1985). Relatively high concentrations of hydrogen peroxide or quaternary ammonium compound are required to give positive results in antibiotic screening tests (Richard and Kerhové, 1975). The amount of chemical sanitizer that might enter milk through lack of rinsing should not be sufficient to cause culture inhibition (Desmazeaud, 1996). However, problems can be encountered when sanitizer solution is not drained from tanks or trucks.

VII. INHIBITORY COMPOUNDS PRODUCED BY STARTER CULTURES

One of the valuable properties of starter cultures is their ability to inhibit growth of undesirable microorganisms. The main preservative action of lactic starter cultures is a result of acid production. Acids produced by lactic acid bacteria include not only lactic acid but also lesser amounts of acetic and formic acids. Production of acids other than lactic acid increases the preservative effect of the culture because, at equivalent pH, acetic and formic acids have greater inhibitory power than lactic acid.

Lactic starter cultures also produce nonacidic microbial inhibitors. These include hydrogen peroxide (which can act by itself or in concert with the lactoperoxidase system as previously discussed), carbon dioxide, low molecular weight carbonyl compounds, and bacteriocins. Production of nonacidic inhibitors by lactic starter cultures is not necessarily advantageous. Undesirable effects include

autoinhibition resulting from hydrogen peroxide (produced when oxygen is present in the milk) and an inability to be used in multiple-strain cultures as a result of bacteriocin production.

A. Low Molecular Weight Nonacidic Metabolites

Kulshrestha and Marth (1974a, 1974b) observed that many nonacidic low molecular weight metabolites of lactic acid bacteria have antimicrobial activity but at concentrations higher than produced in cultured milk. The metabolite with greatest inhibitory activity is the flavor compound, diacetyl (2,3-butanedione). Jay (1982) found that yeasts and gram-negative bacteria are inhibited by 200 ppm diacetyl and that gram-positive bacteria are inhibited by 300 ppm. Although such levels are not found in cultured dairy products, diacetyl may act in combination with other compounds to enhance the preservative effect of starter cultures.

B. linens, when growing in a cheese-containing medium, produces an antimicrobial agent with a broad spectrum of activity, being active against yeasts and molds, *Clostridium botulinum*, *Staphylococcus aureus*, *Salmonella* spp., *Bacillus cereus*, and many yeasts and molds (Grecz, 1964). Volatile sulfur compounds are at least partially responsible for this activity (Beattie and Torrey, 1984).

B. Bacteriocins

Bacteriocins are proteins or polypeptides with potent bactericidal activity. They typically have a narrow spectrum of activity against species closely related to the producing organism. Their production and immunity to their action is plasmid encoded (with some exceptions). Variation in the presence of immunity genes may be responsible for the large variation in bacteriocin sensitivity of lactic acid bacteria (Eijsink et al., 1998). Some bacteriocins are especially interesting, because their broad spectrum of activity may make them useful for inhibiting specific pathogenic or spoilage microorganisms. Activity of some bacteriocins against *Listeria* spp. is presented in Table 6. *Ent. faecium* suitable for use as a starter culture may produce enterocin B, which is active against nisin-resistant mutants of *L. monocytogenes* (Schillinger et al., 1998). Production of bacteriocins by lactic acid bacteria is common, as shown by data in Table 7. However, strains of lactic acid bacteria selected for use in multiple-strain cultures generally do not produce bacteriocins so they do not dominate the mixture. Bacteriocins produced by lactic starter cultures can be divided into three biochemical groups (Barefoot and Nettles, 1993): lanthionine-containing peptides such as nisin and lactacin 481; small non-lanthionine-containing proteins or peptides such as lactacin F, lactacin B, and lactococcin A; and large heat-labile proteins such as helveticin and caseicin 80.

Table 6 Activity of Some Bacteriocins Against *Listeria* Species

Producer organism	Bacteriocin	Inhibition
<i>Lactobacillus</i>		
<i>acidophilus</i>	Lacticin F	—
<i>acidophilus</i>	Lacticin M	—
<i>acidophilus</i>	Lacticin B	—
<i>helveticus</i>	Helveticin J	—
<i>plantarum</i>	Plantaricin A	—
<i>Leuconostoc</i>		
<i>mesenteroides</i>	Mesentericin Y105	+
<i>Lactococcus lactis</i>		
subsp. <i>lactis</i>	Nisin	+
subsp. <i>cremoris</i>	Diplococcin	—
<i>Streptococcus</i>		
<i>thermophilus</i>	Thermophilin 347	+
	Thermophilin A	—
<i>Propionibacterium</i>		
<i>thoenii</i>	Propionicin PLG-1	+
<i>Pediococcus</i>		
<i>acidilactici</i>	Pediocin PA-1	+
<i>pentosaceus</i>	Pediocin A	+

Source: Harris, 1989; Lyon et al., 1993; Stiles, 1994; Villani et al., 1995; and Ward, 1995.

Table 7 Frequency of Bacteriocin Production in Lactic Acid Bacteria

Organism	No. positive/ No. tested	% Positive
<i>Lactobacillus</i> spp.	11/189	6
<i>Lactobacillus</i>		
<i>fermenti</i>	11/121	15
<i>acidophilus</i>	33/152	63
<i>Lactococcus</i> spp.	65/280	23
<i>Streptococcus</i>		
<i>thermophilus</i>	13/41	32
<i>mutans</i>	97/130	75

Source: Klaenhammer, 1988; Tagg, et al, 1976; Ward, 1995.

1. Lactococci

Lc. lactis subsp. *lactis* produces the bacteriocin nisin. Nisin was isolated by Mattick and Hirsch (1947) and is the only bacteriocin widely approved for use as a food additive. (Other bacteriocins can be present in foods as a natural part of the culturing process.) Nisin is a polypeptide containing 34 amino acids and usually occurs as a dimer with a molecular weight of 7000 D (Jarvis et al., 1968). It is the best known of the group of bacteriocins called lantibiotics, which contain the unusual amino acids, lanthionine, β -methyl lanthionine, and dehydroalanine (Vanenbergh, 1993). Nisin has a relatively broad spectrum of activity for a bacteriocin, with activity against many lactic acid bacteria, spore-forming bacteria, and *L. monocytogenes* (Davidson and Hoover, 1993). Its ability to prevent outgrowth of bacterial endospores has led to its use in preventing the late gas defect in hard cheeses and as an inhibitor of *C. botulinum* and spoilage microorganisms in canned foods and processed cheese (Daeschel, 1989). Nisin is heat stable and has greatest activity under mildly acidic conditions. Like other bacteriocins, the site of action of nisin is the cytoplasmic membrane (Sahl, 1991).

Lacticin 481, produced by *Lc. lactis* subsp. *lactis*, has activity against lactococci and some lactobacilli, leuconostocs, and clostridia. If produced by starter cultures used for cheese manufacture, lacticin 481 eliminates the sensitive microflora from the resulting cheese (Paired et al., 1991). *Lc. lactis* subsp. *lactis* DPC3147 produces lacticin 3147, a broad-host range, two-component bacteriocin. It inhibits a wide range of gram-positive bacteria, including *Listeria*, *Clostridium*, *Staphylococcus*, and *Streptococcus* species but is not active against gram-negative species (Ryan et al., 1996). *Lc. lactis* subsp. *cremoris* produces diplococcin, which, unlike nisin, has a narrow spectrum of activity (primarily against other lactococci) and lacks stability. Producers of diplococcin rapidly predominate in multiple-strain starter cultures. Also, *Lc. lactis* subsp. *lactis* var. *diacetylactis* produces lactococcin, a bacteriocin which has a bacteriolytic effect on other lactococci. This lytic action might be useful to accelerate cheese ripening (Morgan et al., 1995).

2. Lactobacilli

Lactobacilli used in starter cultures can produce many different bacteriocins, most with a limited range of activity. *Lb. helveticus* produces helveticin J and lacticin LP27. Helveticin J is an unusual bacteriocin, because it is coded for on chromosomal DNA and is active at neutral pH (Joerger and Klaenhammer, 1986). *Lb. acidophilus* produces numerous bacteriocins, including lacticins B and F and acidocin J1229 (Muriana and Klaenhammer, 1991; Tahara and Kanatani, 1996); *Lb. casei* produces caseicin 80 (Rammelsberg and Radler, 1990); and *Lb. delbrueckii* subsp. *lactis* produces lacticins A and B (Toba et al., 1990). Bacteriocins produced by *Lb. delbrueckii* subsp. *bulgaricus* were recently isolated and character-

ized (Balasubramanyam et al., 1998; Miteva et al., 1998). In addition, *Lb. plantarum*, which grows well in cheese, produces pediocin AcH, a bacteriocin active against *L. monocytogenes* (Ennahar et al., 1996). Properties of these compounds have been described by Davidson and Hoover (1993).

3. Leuconostocs

Although Stiles (1994) concluded that bacteriocins of leuconostocs are active against *L. monocytogenes* but not necessarily against other lactic acid bacteria, three bacteriocins produced by *Leu. mesenteroides* TA 33 inhibited various strains of lactic acid bacteria as well (Papathanasopoulos et al., 1997). In addition, *Leu. mesenteroides* subsp. *dextranicum* J24 synthesizes a bacteriocin named dextranicin 24, which inhibited only other *Leuconostoc* strains (Revol-Junelles and Lefebvre, 1996). *Leu. mesenteroides* subsp. *mesenteroides* produces mesenterocin 52A and mesenterocin 52B (Krier et al., 1998).

4. Propionibacteria

Propionicin PLG-1, a bacteriocin produced by *Pr. thoenii*, is unusual because of its broad range of activity, which includes some gram-negative bacteria, including *Escherichia coli*, *Pseudomonas fluorescens*, and *Vibrio parahaemolyticus* (Lyon and Glatz, 1991). It is also active against other propionibacteria, lactic acid bacteria, and some yeasts and molds. It is inactivated at temperatures above 80°C, unlike jenseniin G, which is produced by *Pr. jensenii* and is stable at 100°C. Jenseniin has a narrow range of activity but is active against microorganisms commonly found in Swiss cheese (Grinstead and Barefoot, 1992). Jenseniin G, which also inhibits yogurt starter, could be useful in preventing overacidification of yogurt (Weinbrenner et al., 1997).

5. Streptococci

Ward (1995) found that 13 of 41 strains of *S. thermophilus* produced bacteriocin-like substances that were active mainly against other *S. thermophilus* strains. He purified the bacteriocin, thermophilin A, which is heat stable and acid tolerant. Villani et al. (1995) isolated thermophilin 347 and determined it to be heat stable and inhibitory toward *L. monocytogenes*. Thermophilin T is also produced by *S. thermophilus* ACA-DC 0040 and is active against some food spoilage bacteria such as *C. sporogenes* and *C. tyrobutyricum* (Aktypis et al., 1998). A bacteriocin produced by *S. thermophilus* 81 was not effective against *Lb. delbrueckii* subsp. *bulgaricus* but inhibited various pathogens (Ivanova et al. 1998).

6. Applications and Commercial Preparations

The dairy industry can take advantage of the preservative properties of bacteriocins either by using bacteriocin-producing cultures in the manufacturing process

or by adding the bacteriocin-containing preparations directly to a product. Nisin can be purchased for use as a food additive under the brand name Nisaplin (Aplin and Barret, Ltd., Wilts, England). It is mainly used in dairy foods for its ability to inhibit bacterial spore germination.

Skim milk fermented with a bacteriocin-producing strain of *P. freudenreichii* subsp. *shermanii*, and when pasteurized, it can be purchased under the brand name Microgard (Wesman Food, Inc., Beaverton, OR). The presence of propionic acid, diacetyl, and acetic acid in Microgard enhances the preservative effect of the bacteriocin (Al-Zoreky, 1988). Microgard is used extensively in the United States as a preservative in cottage cheese (Daeschel, 1989). Other fermented milk and whey products containing bacteriocins are also commercially available. In addition, a novel method for accelerating cheese ripening utilizes bacteriocin-producing adjunct cultures. The use of a bacteriocin-producing strain of *Lc. lactis* subsp. *lactis* resulted in cheese with increased cell lysis, elevated concentration of free amino acids, and higher sensory evaluation scores (Morgan et al., 1997).

VIII. MEASUREMENT OF STARTER ACTIVITY

The term *activity* refers to the ability of starter cultures to produce desirable changes in fermented dairy products. Activity is a consequence of many factors, some of which are difficult to quantify, such as physiological state of cultures, growth conditions, harvesting, and packaging and storage conditions (Spinnler and Corrieu, 1989). Usually activity measurements are confined to the ability of starter cultures to acidify milk.

Most activity tests are based on rapid quantification of acid production for the purpose of strain selection, comparison of different combinations of defined starters, determining the best harvesting time, or determining culture stability during storage. Ideally, before activity measurement, cultures should be subcultured twice, cultured overnight in the appropriate broth medium at optimum growth temperature, and centrifuged at $20000 \times g$ at 4°C for 5 min. The pellet is then washed at 4°C with 50 mM potassium phosphate buffer, pH 6.7, resuspended in the same buffer at 5 mM to minimize buffer capacity, and adjusted to A_{650} for use as an inoculum (Demirci and Hemme, 1995). The classic way to determine starter activity is by measuring the pH of the culture at different time intervals. Maximum acidification rate (V_m) (Spinnler and Corrieu, 1989), the capacity of a culture to respond to a new environment (Barreto et al. 1991), and the biomass measurement (Olivares et al., 1993) may all be useful determinations. Activity can be measured by means other than pH, including conductance and impedance (Lanzanova et al., 1993; Tsai and Luedecke, 1989). These measurements estimate the activity of stored cultures within less than an hour. Activities other than acid production such as proteolysis (Demirci and Hemme, 1995),

lipolysis (Kenneally et al., 1998), and β -galactosidase production (Ord'Zez and Jeon, 1995) can also be determined by other means.

IX. STARTER CULTURES INTERACTIONS

Mixed starter cultures may be composed of various genera, species, and strains of lactic acid bacteria which together make up a dynamic, complex culture. Their strain components will differ in growth rate, acid production, aroma production, proteolytic activity, bacteriocin production and sensitivity, and phagic resistance. Milk composition can affect strain dominance; for example, the very low concentration of Mn^{2+} in winter milk leads to poor growth and low numbers of *Leuconostoc* in a mixed starter (DeMan and Galesloot, 1962).

Different types of interactions can occur in strain mixtures and affect culture performance (Hugenholtz, 1986) (Table 8). This could lead to slow acidification and modification of texture and organoleptic properties of fermented milk products. Sometimes more than one interaction can occur among particular strains. For example, the interaction between propionibacteria and *Lb. plantarum* in Swiss cheese changes from commensalism to mutualism when lactic acid is accumulated and *Lactobacillus* starts to benefit from its removal by propionibacteria.

The nature of the interaction among mixed cultures is strain dependent. Day-to-day transfer of mixed cultures should be employed with caution unless they have previously demonstrated maintenance of the original proportions through several transfers.

X. ADJUNCT CULTURES

Adjunct or secondary cultures are those added to cheese for purposes other than acid production. Such cultures are used to intensify and modify cheese flavor and to accelerate flavor development. Because adjunct cultures grow during cheese ripening rather than during curd manufacture, they are unlikely to support phage production. Examples of adjunct cultures are *Pr. freudenreichii* subsp. *shermanii* in Swiss cheese, *B. linens* in surface smear-ripened cheese, and *P. camemberti* in surface mold-ripened cheeses. In Cheddar cheese making, adjunct cultures include lactose-negative *Lc. lactis* subsp. and attenuated (heat-shocked, freeze-shocked, or solvent-treated) cultures (Fox et al. 1998). Some adjunct cultures such as thermophilic *Lactobacillus* spp. that do not grow to a significant extent in Cheddar cheese can serve as a source of ripening enzymes. In addition, replacing part of a bitter-producing starter with thermophilic *Lactobacillus* cultures avoids bitterness development (Fox et al., 1998). However, using a high level

Table 8 Possible Interactions Among Dairy Starter Culture Strains

Type of interaction	Definition	Examples
Competition	Populations of two species are mutually limiting because of their joint dependence on a common factor or factors external to them	1. In Cheddar cheese (high cooking temperature), <i>Lc. lactis</i> subsp. <i>lactis</i> will dominate 2. Competition for nitrogen nutrients will cause <i>Lc. lactis</i> to dominate in culture containing <i>Leu. mesenteroides</i>
Amensalism	Inhibition of other species by removal of essential nutrients or formation of toxic metabolites	<i>Lc. lactis</i> subsp. <i>lactis</i> producing nisin inhibits sensitive strains in mixed cultures
Commensalism	The species which benefits from another does not provide a benefit in return	The prt ⁻ variants might profit from the prt ⁺ variants without providing any benefit in return
Parasitism	One organism feeds or reproduces at the expense of another that is necessarily damaged by the relationship	Phage-resistant strains having low growth rate will have higher populations in the presence of bacteriophage
Mutualism	Both species benefit from co-growth	<i>S. thermophilus</i> and <i>Lb. delbrueckii</i> ssp. <i>bulgaricus</i> in yogurt cultures exchange growth factors

of thermophilic *Lactobacillus* cultures in Cheddar cheese may alter the flavor. Recently, adjunct cultures of bacteriocin-producing strains were used to facilitate starter culture lysis and accelerate cheese ripening (Martinez-Cuesta et al., 1998; Morgan et al., 1995).

XI. USE OF GENETICALLY MODIFIED STARTER CULTURES

Conventional strain development relies on selection of natural strains and mutants. However, new technology in genetic manipulation, isolation, and gene

Table 9 Examples of Genetic Modifications of Dairy Starter Cultures

Species	Modification	References
<i>Lb. casei</i>	Transfer peptidase and transport genes from <i>Lb. delbrueckii</i> subsp. <i>lactis</i>	Klein et al., 1995
<i>Lc. lactis</i> subsp.	Creation of a strain deficient in nisin A production	Kuipers et al., 1993
<i>Lc. lactis</i> subsp.	Overexpression of proteases or peptidases	De Vos and Simons, 1994
<i>Lc. lactis</i>	Transcriptional regulation and evolution of lactose genes in the galactose-lactose operon	Vaughan et al. 1998
<i>Lc. lactis</i> subsp. <i>lactis</i>	Lac ⁺ Muc ⁺ variants of plasmid-free strains	Wright and Tykkynen, 1987
<i>Lc. lactis</i>	Design of a phage-insensitive strain	O' Sullivan et al., 1998
<i>Lc. lactis</i>	β-galactosidase gene from <i>Lb. plantarum</i> was cloned and expressed in <i>Lc. lactis</i>	Mayo et al., 1994
<i>Lc. lactis</i> <i>Pediococcus</i>	Increasing diacetyl production Improve lactose and galactose uptake and increasing phospho-beta galactosidase activity by transferring a lactose plasmid from <i>Lc. lactis</i>	Benson et al., 1994 Caldwell et al., 1996
<i>Lc. lactis</i> subsp. <i>lactis</i>	Prt ⁻ strains were converted to Prt ⁺ by transformation of proteinase gene complex from <i>Lc. lactis</i> subsp. <i>cremoris</i>	Kok et al., 1985
<i>Lc. lactis</i> subsp. <i>lactis</i> var. <i>diacetyllactis</i>	Lac ⁺ phenotype was produced by transferring of lactose plasmids from <i>Lc. lactis</i> subsp. <i>lactis</i>	Kempler and McKay, 1979
<i>Lc. lactis</i>	Transfer of a phage-resistance plasmid	Coakley et al., 1997
<i>Lc. lactis</i>	Expression of lysin from native phage led to rapid lysis to accelerate cheese ripening	Shearman et al. 1992
<i>Lc. lactis</i> subsp. <i>lactis</i> and <i>Lc. lactis</i> subsp. <i>cremoris</i>	Phage resistance	Sanders et al., 1986
<i>Lc. lactis</i> subsp. <i>lactis</i>	Improvement of proteolytic activity by integration of a plasmid-encoded proteinase gene from <i>Lc. lactis</i> subsp. <i>cremoris</i>	Leenhouts et al., 1991

transfer holds much promise for improved dairy strains. Genetic engineering techniques allow directed changes in existing traits, exchange of traits (protease, bacteriocins, carbohydrate metabolism) among closely related strains or species, and introduction of foreign genes from unrelated strains (Sanders, 1991). Methods for introducing genes into a new strain include conjugation, transformation, and transduction.

Although consumption of lactic acid bacteria modified by deletion of genetic information or other self-cloning procedures might not influence potential hazards of consuming fermented milk products, safety concerns should still be taken into account. These include possible interactions with the foodborne pathogenic microorganisms as well as possible influences on process technology and on nutritional value and allergenic potential of products (Klein et al., 1995).

Among all lactic starter species, mesophilic lactococci are the most studied host system. Table 9 provides references on the significant genetic modifications applied to dairy starter species.

Bacteriophage infection is the single most important cause of slow acid production in dairy fermentations. Consequently, there has been a worldwide research effort focusing on transferring of different phage resistance traits to improve dairy starter culture performance in the presence of industrial phage. However, genetically engineered defense strategies (nonnatural) in lactic acid bacteria suffer the weakness of being highly specific. At present, conjugal transfer of naturally occurring plasmids is the only accepted approach for genetic improvement of starter cultures, although food-grade cloning systems may be considered in the future (Coakley et al., 1997). In lactococci, there is a genetic linkage between phage resistance and bacteriocin production. Phage resistance transconjugants were identified by their ability to ferment lactose and their resistance to the produced bacteriocin (Coakley et al., 1997). Phage resistance is associated with the sucrose-nisin transposon in lactococci (Gireesh et al., 1992).

Although genetic information presently available allows construction of tailor-made genetically modified lactic acid bacteria, the use of genetically engineered starter cultures will depend on cost of strain development, regulations, and consumer acceptance. Although, recombinant DNA technology provides a potential improvement over the classic methodology of selection, mutation and strain screening will continue in the immediate future. See Chapter 8 for further discussion of genetics of lactic acid bacteria.

REFERENCES

- Aktypis A, Kalantzopoulos G, Huis in't Veld J, Brink B. Purification and characterization of thermophilin T, a novel bacteriocin produced by *Streptococcus thermophilus* ACA-DC 0040. *J Appl Microbiol* 84:568, 1998.

- Allison G, Klaenhammer T. Phage resistance mechanisms in lactic acid bacteria. *Int Dairy J* 8:207, 1998.
- Al-Zoreky N. Microbiological control of food spoilage and pathogenic microorganisms in refrigerated foods. MS thesis, Oregon State University, Corvallis, OR, 1988.
- Anonymous. Bacteriophage. Milwaukee: Chr. Hansen's Laboratory, Inc, 1990.
- Ariga H, Urashima T, Michihata E, Manabu I, Morizono N, Kimura T, Takahashi S. Extracellular polysaccharide from encapsulated *Streptococcus salivarius* subsp. *thermophilus* OR 901 isolated from commercial yogurt. *J Food Sci* 57:625, 1992.
- Axelsson LT. Lactic acid bacteria: classification and physiology. In: Salminen S, von Wright A, eds. *Lactic Acid Bacteria*. New York: Marcel Dekker, 1993, p 1.
- Balasubramanyam B, Varadaraj, M. Cultural conditions for the production of bacteriocin by a native isolate of *Lactobacillus delbrueckii* ssp. *bulgaricus* CFR 2028 in milk medium. *J Appl Microbiol* 84:97, 1998.
- Barefoot SF, Nettles CG. Antibiosis revisited: bacteriocins produced by dairy starter cultures. *J Dairy Sci* 76:2366, 1993.
- Barreto M, Melo E, Almeida, J, Xavier A, Carrondo M. A kinetic method for calculating the viability of lactic starter cultures. *Appl Microbiol Biotechnol* 34:648, 1991.
- Barrett N, Grandison A, Lewis M. Contribution of the lactoperoxidase system to the keeping quality of pasteurized milk. *J Dairy Res* 66:73, 1999.
- Batish VK, Chandler H, Zumdigni KC, Bhatia KL, Singh RS. Antibacterial activity of lactoferrin against some common food-borne pathogenic organisms. *Aust J Dairy Technol* 43:16, 1988.
- Beal C, Llouvet P, Corrieu G. Influence of pH, lactose and lactic acid on growth and acidification of pure cultures of *Streptococcus thermophilus* 404 and *Lactobacillus bulgaricus* 398. *Appl Microbiol Biotechnol* 32:148, 1989.
- Beattie SE, Torrey GS. Volatile compounds produced by *Brevibacterium linens* inhibit mold spore germination (abstr). *J Dairy Sci* 67(Suppl 1):84, 1984.
- Beneke ES, Stevenson KE. Classification of food and beverage fungi. In: Beuchat LR, ed. *Food and Beverage Mycology*. 2nd ed. New York: Van Nostrand Reinhold, 1987, p 1.
- Benkerroum N, Misbah M, Sandine W, Elaraki A. Development and use of a selective medium for isolation of *Leuconostoc* sp. from vegetables and dairy products. *Appl Environ Microbiol* 59:607, 1993.
- Benson K, Godon J, Renault P, Griffin H, Gasson M. Effect of *ilvBN*-encoded alpha-acetolactate synthase expression on the diacetyl production in *Lactobacillus lactis*. *Appl Microbiol Biotechnol* 45:107, 1994.
- Beshkova D, Simova E, Frengova G, Simov Z. Production of flavor compounds by yogurt starter cultures. *J Ind Microbiol Biotechnol* 20:180, 1998.
- Boysen M, Skouboe P, Frisvad J, Rossen L. Reclassification of the *Penicillium roqueforti* group into three species on the basis of the molecular genetic and biochemical profiles. *Microbiology* 142:541, 1996.
- Brock TD. *Milestones in Microbiology*. Englewood Cliffs, NJ:Prentice-Hall, 1961.
- Brussow H, Fremont M, Bruttin A, Sidoti J, Constable A, Fryder V. Detection and classification of *Streptococcus thermophilus* bacteriophages isolated from industrial milk fermentation. *Appl Environ Microbiol* 60:4537, 1994.

- Bruttin A, Desiere F, D' Amico N, Guerin J, Sidoti J, Huni B, Lucchini S, Brussow H. Molecular ecology of *Streptococcus thermophilus* bacteriophage infections in a cheese factory. *Appl. Environ Microbiol* 63:3144, 1997.
- BuchenhÜskes H. Selection criteria for lactic acid bacteria to be used as starter cultures for various food commodities. *FEMS Microbiol Rev* 12:253, 1993.
- Bury D, Jelen P, Kimura K. Whey protein concentrate as a nutrient supplement for lactic acid bacteria. *Int Dairy J* 8:149, 1998.
- Caldwell S, Hutkins R, McMahon D, Oberg C, Broadbent J. Lactose and galactose uptake by genetically engineered *Pediococcus* species. *Appl Microbiol Biotechnol* 49:315, 1998.
- Cerning J. Exocellular polysaccharides produced by lactic acid bacteria. *FEMS Microbiol Rev* 87:113, 1990.
- Cerning J, Bouillanne C, Desmazeaud MJ, Landon M. Isolation and characterization of exocellular polysaccharide produced by *Lactobacillus bulgaricus*. *Biotechnol Lett* 8:625, 1986.
- Cerning J, Bouillanne C, Landon M, Desmazeaud MJ. Exocellular polysaccharide production by *Streptococcus thermophilus*. *Biotechnol Lett* 10:255, 1988.
- Champagne CP, Gardner N, Brochu E, Beaulieu Y. The freeze-drying of lactic acid bacteria. A review. *Can Inst Sci Technol J* 24:118, 1991.
- Charteris W, Kelly P, Morelli L, Collins J. Selective detection, enumeration and identification of potentially probiotic *Lactobacillus* and *Bifidobacterium* species in mixed bacterial populations. *Int J Food Microbiol* 35:1, 1997.
- Charteris W, Kelly P, Morelli L, Collins J. Ingredient selection criteria for probiotic microorganisms in functional dairy foods. *Int J Dairy Technol* 51:123, 1998.
- Chassy B, Murphy C. *Lactococcus* and *Lactobacillus*. In: Sonenshein AL, Hoch JA, Losick R. eds. *Bacillus subtilis* and Other Gram-Positive Bacteria. Washington, DC: American Society for Microbiology, 1993, p 65.
- Chen CM, Bogenrief DB, Jaeggi JJ, Tricomi WA, Johnson ME. Evaluation of mixer molder temperature and speed on composition, functional and sensory characteristics of 50% reduced-fat mozzarella cheese. *J Dairy Sci* 77(Suppl 1):15, 1994.
- Chopin MC. Resistance of 17 mesophilic lactic *Streptococcus* bacteriophages to pasteurization and spray-drying. *J Dairy Res* 47:131, 1980.
- Coakley M, Fitzgerald G, Ross R. Application and evaluation of the phage resistance- and bacteriocin-encoding plasmid pMRC01 for the improvement of dairy starter cultures. *Appl Environ Microbiol* 63:1434, 1997.
- Cogan TM. History and taxonomy of starter cultures. In: Cogan TM, Accolas JP, eds. *Dairy Starter Cultures*. New York: VCH, 1996, p 1.
- Cogan TM, Accolas JP. Starter cultures: types, metabolism and bacteriophage. In: Robinson RK, ed. *Dairy Microbiology: The Microbiology of Milk*. London: Elsevier, 1990, p 77.
- Collins EB. Influence of medium and temperature on end products and growth. *J Dairy Sci* 60:799, 1976.
- Commings CS, Johnson JL. *Propionibacterium*. In: Butler JP, ed. *Bergey's Manual of Systematic Bacteriology*. Vol II. Baltimore: Williams & Wilkins, 1984, p 1346.
- Conn HW. *Dairy Bacteriology*. Bulletin No. 25. Washington, DC: U.S. Department of Agriculture Office of Experiment Stations, 1895.

- Daeschel MA. Antimicrobial substances from lactic acid bacteria for use as food preservatives. *Food Technol* 43:164, 1989.
- Dave RI, Shah NP. Evaluation of media for selective enumeration of *Streptococcus thermophilus*, *Lactobacillus delbrueckii* subsp. *bulgaricus*, *Lactobacillus acidophilus* and bifidobacteria. *J Dairy Sci* 79:1529, 1996.
- Davidson MP, Hoover DG. Antimicrobial components from lactic acid bacteria. In: Salmiinen S, von Wright A, eds. *Lactic Acid Bacteria*. New York: Marcel Dekker, 1993, p 127.
- Davidson BE, Powell IB, Hillier AJ. Temperate bacteriophages and lysogeny in lactic acid bacteria. *FEMS Microbiol Rev* 87:79, 1990.
- DeMan J, Galesloot T. De invloed van een toevoeging van mangaan aan de melk op de groei van zuurselbacterien. *Neth Milk Dairy J* 16:1, 1962.
- DeMan J, Rogosa M, Elizabeth M. A medium for the cultivation of lactobacilli. *J Appl Bacteriol* 23:130, 1960.
- Demirci Y, Hemme D. Acidification test based on the use of biomass for screening of *Leuconostoc*. Application to *Leuconostoc mesenteroides* strains isolated from French raw milk cheeses. *J Dairy Res* 62:521, 1995.
- Desmazeaud M. Growth inhibitors of lactic acid bacteria. In: Cogan TM, Accolas JP, eds. *Dairy Starter Cultures*. New York: VCH, 1996, p 131.
- De Vos W, Simmons G. Gene cloning and expression systems in lactococci. In: Gasson M, De Vos W, eds. *Genetics and Biotechnology of Lactic Acid Bacteria*. Glasgow: Chapman & Hall, 1994, p 52.
- Dinsmore PK, Klaenhammer TR. Bacteriophage resistance in *Lactococcus*. *Mol Biotechnol* 4:297, 1995.
- Dunsmore D. Effect of residues of five disinfectants in milk on acid production by strains of lactic starters used for cheddar cheesemaking and on organoleptic properties of the cheese. *J Dairy Res* 52:287, 1985.
- Durmaz E, Klaenhammer TR. A starter culture rotation strategy incorporating paired restriction/modification and abortive infection bacteriophage defenses in a single *Lactococcus lactis* strain. *Appl Environ Microbiol* 61:1266, 1995.
- Eijsink VGH, Skeie M, Middelhoven PH, Brurberg MB, Nes, IF. Comparative studies of class IIa bacteriocins of lactic acid bacteria. *Appl Environ Microbiol* 64:3275, 1998.
- Elliker P, Anderson A, Hannesson G. 1956. An agar culture medium for lactic acid streptococci and lactobacilli. *J Dairy Sci* 39:1611, 1956.
- Ennahar S, Aoude-werner D, Sorokine O, Dorselaer A, Bringel F, Hubert J, Hasselmann C. Production of pediocin AcH by *Lactobacillus plantarum* WHE92 isolated from cheese. *Appl Environ Microbiol* 62:4381, 1996.
- Forde A, Fitzgerald G. 1999. Bacteriophage defense systems in lactic acid bacteria. *Antonie van Leeuwenhoek* 76:89, 1999.
- Fox PF, McSweeney PL, Lynch CM. Significance of non-starter lactic acid bacteria in cheddar cheese. *Aust J Dairy Technol* 53:83, 1998.
- Fringa E, Holtz C, Kunz B. Studies about casein degradation by *Brevibacterium linens*. *Milchwissenschaft* 48:130, 1993.
- Frisvad JC, Filtenborg O. Terverticillate penicillia: chemotaxonomy and mycotoxin production. *Mycologia* 81:837, 1989.

- Fryer TF, Peberdy MF. Growth of propionibacteria in Swiss and Egmont cheese. *NZ J Dairy Sci Technol* 12:133, 1977.
- Garcia-Garibay M, Marshall, VME. Polymer production by *Lactobacillus delbrueckii* ssp. *bulgaricus*. *J Appl Bacteriol* 70:325, 1991.
- Garvey P, Hill C, Fitzgerald G. The lactococcal plasmid pNP40 encodes a third bacteriophage resistance mechanism, one which affects phage DNA penetration. *Appl Environ Microbiol* 62:676, 1996.
- Geller B, Kraus J, Schell M, Hornsby M, Neal J, Ruch F. High titer, phage-neutralizing antibodies in bovine colostrum that prevent lytic infection of *Lactococcus lactis* in fermentations of phage-contaminated milk. *J Dairy Sci* 81:895, 1998.
- Ghoddusi H, Robinson R. Enumeration of starter cultures in fermented milk. *J Dairy Sci* 63:151, 1996.
- Gireesh T, Davidson B, Hillier A. Conjugal transfer in *Lactococcus lactis* of a 68-kilobase-pair chromosomal fragment containing the structural gene for the peptide bacteriocin nisin. *Appl Environ Microbiol* 58:1670, 1992.
- Glatz BA. The classical propionibacteria: their past, present and future as industrial organisms. *ASM News* 58:197, 1992.
- Grandison AS, Brooker BE, Young P, Ford GD, Underwood HM. Sludge formation during the manufacture of cottage cheese. *J Soc Dairy Technol* 39:119, 1986.
- Grecz N. Natural antibiosis in some varieties of soft surface ripened cheese. In: Melin N, ed. *Microbial Inhibitors in Food*. Stockholm: Almqvist and Wiksell, 1964, p 307.
- Ginstead DA, Barefoot SF, Jensenin G. A heat-stable bacteriocin produced by *Propionibacterium jensenii* P126. *Appl Environ Microbiol* 58:215, 1992.
- Guirguis N, Hickey MW. Factors affecting the performance of thermophilic starters. 1. Sensitivity to dairy starters. *Aust J Dairy Technol* 41:11, 1987a.
- Guirguis N, Hickey MW. Factors affecting the performance of thermophilic starters. 2. Sensitivity to the lactoperoxidase system. *Aust J Dairy Technol* 41:14, 1987b.
- Gulstrum TJ, Pearce LE, Sandine WE, Elliker PR. Evaluation of commercial phage inhibitory media. *J Dairy Sci* 62:208, 1979.
- Harris LJ, Daeschel MA, Stiles ME, Klaenhammer TR. Antimicrobial activity of lactic acid bacteria against *Listeria monocytogenes*. *J Food Prot* 52:384, 1989.
- Harrits J, McCoy D. Swiss cheese. In: *Cultures for the Manufacture of Dairy Products*. Milwaukee: Chr. Hansen, Inc, 1997, p 79.
- Harvey RJ. Damage to *Streptococcus lactis* resulting from growth at low pH. *J Bacteriol* 11:1330, 1965.
- Hassan AN, Frank JF. Modification of microstructure and texture of rennet curd by using a capsule-forming non-ropy lactic culture. *J Dairy Res* 64:115, 1997.
- Hassan AN, Frank JF, Farmer MA, Schmidt KA, Shalabi SI. Observation of encapsulated lactic acid bacteria using confocal scanning laser microscopy. *J Dairy Sci* 78:2624, 1995a.
- Hassan AN, Frank JF, Farmer MA, Schmidt KA, Shalabi SI. Formation of yogurt microstructure and three-dimensional visualization as determined by confocal scanning laser microscopy. *J Dairy Sci* 78:2629, 1995b.
- Hassan AN, Frank JF, Schmidt KA, Shalabi SI. Rheological properties of yogurt made using encapsulated nonropy lactic cultures. *J Dairy Sci* 78:2091, 1996a.

- Hassan AN, Frank JF, Schmidt KA, Shalabi SI. Textural properties of yogurt made using encapsulated nonropy lactic cultures. *J Dairy Sci* 78:2098, 1996b.
- Haysahi K, Cliffe AJ, Law BA. Culture conditions of *Brevibacterium linens* for production of proteolytic enzymes. *Nippon Shokuhin Kogyo Gakkaishi* 37:737, 1990.
- Hettinga DG, Reinbold GW, Vedamuthu ER. Split defect of Swiss cheese. I. Effect of strain of *Propionibacterium* and wrapping material. *J Milk Food Technol* 37:322, 1974.
- Hickey MW, Hillier AJ, Jago GR. Enzymatic activities associated with lactobacilli in dairy products. *Aust J Dairy Technol* 38:154, 1983.
- Hicks CL, Hamzah B. Effect of culture agglutination on cottage cheese yield. *Cult Dairy Prod J* 27:4, 1992.
- Hicks CL, Ibrahim SA. Lactic bulk starter homogenization affects culture agglutination. *J Food Sci* 57:1086, 1992.
- Hicks C, Morales M, Russell-Campbell E. Use of agglutination-sensitive bulk starters in the manufacture of stirred curd cheese. *J Dairy Sci* 81:621, 1998.
- Hill C. Bacteriophage and bacteriophage resistance in lactic acid bacteria. *FEMS Microbiol Rev* 12:87, 1993.
- Hirano R, Hirano M, Oooka M, Dosako S, Nakajima I, Igoshi K. Lactoperoxidase effects on rheological properties of yogurt. *J Food Sci* 63:35, 1998.
- Holtz C, Kunz B. Studies on degradation of whey proteins by *Brevibacterium linens*. *Milchwissenschaft* 49:130, 1994.
- Hugenholtz J. Population dynamics of mixed starter cultures. *Neth Milk Dairy J* 40:129, 1986.
- Huggins AR. Progress in dairy starter technology. *Food Technol* 38:41, 1984.
- Hughes KA, Sutherland IW, Jones MV. Biofilm susceptibility to bacteriophage attack: the role of phage-borne polysaccharide depolymerase. *Microbiology* 144:3039, 1998.
- Hull R, Roberts A. Differential enumeration of *Lactobacillus acidophilus* in yogurt. *Aust J Dairy Technol* 3:160, 1984.
- Hutkins R, Halambeck SM, Morris HA. Use of galactose-fermenting *Streptococcus thermophilus* in the manufacture of Swiss, mozzarella, and short-method cheddar cheese. *J Dairy Sci* 69:1, 1986.
- Ivanova I, Miteva V, Stefanova Ts, Pantev A, Budakov I, Danova S, Moncheva P, Nikolaova I, Dousset X, Boyaval P. Characterization of a bacteriocin produced by *Streptococcus thermophilus* 81. *Int J Food Microbiol.* 42:147, 1998.
- Jarvis AW. Bacteriophages of lactic acid bacteria. *J Dairy Sci* 72:3406, 1989.
- Jarvis B, Jeffcoat J, Cheeseman GC. Molecular weight distribution of nisin. *Biochim Biophys Acta* 168:153, 1968.
- Jay JM. Antimicrobial properties of diacetyl. *Appl Environ Microbiol* 44:525, 1982.
- Joerger MC, Klaenhammer TR. Characterization and purification of helveticin J and evidence for a chromosomally determined bacteriocin produced by *Lactobacillus helveticus* 481. *J Bacteriol* 167:439, 1986.
- Jollivet N, Bezenger MC, Vayssier Y, Belin JM. Production of volatile compounds in liquid cultures by six strains of coryneform bacteria. *Appl Microbiol Biotechnol* 36:790, 1992.
- Jollivet N, Belin JM, Vayssier Y. Comparison of volatile flavor compounds produced by ten strains of *Penicillium camemberti* Thom. *J Dairy Sci* 76:1837, 1993.

- Kempler G, McKay L. Genetic evidence for plasmid-linked lactose metabolism in *Streptococcus lactis* subsp. *diacetylactis*. Appl Environ Microbiol 37:1041, 1979.
- Kenneally P, Leuschner R, Arendt E. Evaluation of the lipolytic activity of starter cultures for meat fermentation purposes. J Appl Microbiol 84:839, 1998.
- Kinsella JE, Hwang D. Biosynthesis of flavors by *Penicillium roqueforti*. Biotechnol Bioeng 18:927, 1976.
- Klaenhammer TR. Bacteriocins of lactic acid bacteria. Biochemie 70:337, 1988.
- Klaenhammer TR. Development of bacteriophage-resistant strains of lactic acid bacteria. Food Biotechnol 19:675, 1991.
- Klein J, Wegmann C, Meyer-Barton E, Plapp R, Henrich B. 1995. Molecular tools for the genetic modification of dairy lactobacilli. System Appl Microbiol 18:493, 1995.
- Klien G, Pack A, Bonaparte C, Reuter G. Taxonomy and physiology of probiotic lactic acid bacteria. Int J Food Microbiol 41:103, 1998.
- Knudson S. Starters. J Dairy Res 2:137, 1931.
- Kok J, van Dijl J, van der Vossen J, Venema G. Cloning and expression of a *Streptococcus cremoris* proteinase in *Bacillus subtilis* and *Streptococcus lactis*. Appl Environ Microbiol 50:94, 1985.
- Korhonen H. Antimicrobial factors in bovine colostrum. J Sci Agr Soc Finland 49:434, 1977.
- Krier F, Revol-Junelles AM, Germain P. Production of two bacteriocins by *Leuconostoc mesenteroides* subsp. *mesenteroides* FR52 during batch fermentation. Appl Microbiol Biotechnol 50:359, 1998.
- Kuipers O, Beerthuyzen M, Siezen R, De Vos W. Characterization of the nisin gene cluster nisABTCIPR of *Lactococcus lactis*. Requirement of expression of the nisA and nisI genes for development of immunity. Eur J Biochem 216:281, 1993.
- Kulshrestha DC, Marth EH. Inhibition of bacteria by some volatile and non-volatile compounds associated with milk. II. *Salmonella typhimurium*. J Milk Food Technol 37: 539, 1974a.
- Kulshrestha DC, Marth EH. Inhibition of bacteria by some volatile and non-volatile compounds associated with milk. IV. *Streptococcus lactis*. J Milk Food Technol 37: 593, 1974b.
- Lambboley L, Lacroix C, Champagne CP, Vuilleumard JC. Continuous mixed strain mesophilic lactic starter production in supplemented whey permeate medium using immobilized cell technology. Biotechnol Bioeng 56:502, 1997.
- Lanzanova M, Mucchetti G, Neviani E. Analysis of conductance changes as a growth index of lactic acid bacteria in milk. J Dairy Sci 76:20, 1993.
- Law J, Haandrikman A. Proteolytic enzymes of lactic acid bacteria. Int. Dairy J 7:1, 1997.
- Leenhouts K, Gietema J, Kok J, Venema G. Chromosomal stabilization of the proteinase genes in *Lactococcus lactis*. Appl Environ Microbiol 57:2568, 1991.
- Lim K, Huh C, Baek Y, Kim H. A selective enumeration medium for bifidobacteria in fermented dairy products. J Dairy Sci 78:2108, 1995.
- Limsowtin G. Inhibition of starter cultures. Aust J Dairy Technol 47:100, 1992.
- Limsowtin G, Heap HA, Lawrence RC. A new approach to the preparation of bulk starter in commercial cheese plants. NZ J Dairy Sci Technol 15:219, 1980.
- Lindsay RC, Day EA, Sandine WE. Green flavor defect in starter cultures. J Dairy Sci 46:863, 1965.

- Lodics TA, Steenson LR. Phage-host interactions in commercial mixed-strain dairy starter cultures: practical significance-a review. *J Dairy Sci* 76:2380, 1993.
- Low D, Ahlgren J, Horne D, McMahon D, Oberg C, Broadbent J. Influence of *Streptococcus thermophilus* MR-1C capsular exopolysaccharide on cheese moisture level. *Appl Environ Microbiol* 64:2147, 1998.
- Lyon WJ, Glatz BA. Partial purification and characterization of a bacteriocin produced by *Propionibacterium thoenii*. *Appl Environ Microbiol* 57:701, 1991.
- Lyon WJ, Glatz BA. Propionibacteria. In: Hui YH, Khachatourians GG, eds. *Food Biotechnology Microorganisms*. New York: VCH, 1995, p 703.
- Lyon WJ, Sethi JK, Glatz BA. Inhibition of psychrotrophic organisms by propionicin PLG-1, a bacteriocin produced by *Propionibacterium thoenii*. *J Dairy Sci* 76:1506, 1993.
- Marshall VM, Bramley J. Stimulation of *Streptococcus thermophilus* growth in mastitic milk. *J Dairy Res* 51:17, 1984.
- Marshall VM, Cole WM. Threonine aldolase and alcohol dehydrogenase activities in *Lactobacillus bulgaricus* and *Lactobacillus acidophilus* and their contribution to flavour production in fermented foods. *J Dairy Res* 50:375, 1983.
- Marshall VM, Tamime AY. 1997. Starter cultures employed in the manufacture of biofermented milks. *Int J Dairy Technol* 50:35, 1997.
- Martinez-Cuesta MC, Fernandez de Palencia P, Requena T, Pelaez C. Enhancement of proteolysis by a *Lactococcus lactis* bacteriocin producer in a cheese model system. *J Agr Food Chem* 46:3863, 1998.
- Masson S, Heremans JF. Lactoferrin in milk from different species. *Comp Biochem Physiol* 39B:119, 1971.
- Matalan M, Sandine W. Improved media for differentiation of rods and cocci in yogurt. *J Dairy Sci*. 69:2569, 1986.
- Mattick ATR, Hirsch A. Further observation on an inhibitor (nisin) from lactic streptococci. *Lancet* 2:5, 1947.
- Matzdorf B, Cuppett S, Keeler L, Hutkins R. Browning of mozzarella cheese during high temperature pizza baking. *J Dairy Sci* 77:2850, 1994.
- Mayo B, Gonzalez B, Arca P, Suarez J. Cloning and expression of the plasmid encoded beta D galactosidase gene from a *Lactobacillus plantarum* strain of dairy origin. *FEMS Microbiol Lett* 122:145, 1994.
- Mäyrä-Mäkinen A, Bigret M. Industrial use and production of lactic acid bacteria. In: Salminen S, von Wright A, eds. *Lactic Acid Bacteria*. New York: Marcel Dekker, 1993, p 65.
- McCoy DR. Italian type cheeses. In: *Cultures for the Manufacture of Dairy Products*. Milwaukee: Chr. Hansen, Inc, 1997, p 70.
- McCoy DR, Leach RD. Culture propagation and handling. In: *Cultures for the Manufacture of Dairy Products*. Milwaukee: Chr. Hansen, Inc, 1997, p 32.
- McDonald L, Mc Feeters R, Daeschel M, Fleming H. 1987. A differential medium for the enumeration of homofermentative and heterofermentative lactic acid bacteria. *Appl Environ Microbiol* 53:1382, 1987.
- Mermelstein NH. Advanced bulk starter medium improves fermentation process. *Food Technol*. 34(8):69, 1982.

- Mills OE, Thomas TD. Bitterness development in cheddar cheese: effect of the level of starter proteinase. *NZ J Dairy Sci Technol* 15:131, 1980.
- Miteva V, Stefanova T, Budakov I, Vanova I, Mitev V, Gancheva A, Liubenov M. Characterization of bacteriocins produced by strains from traditional Bulgarian dairy products. *System Appl Microbiol* 21:151, 1998.
- Moineau S, Pandian S, Klaenhammer TR. Evolution of lytic bacteriophage via DNA acquisition from the *Lactococcus lactis* chromosome. *Appl Environ Microbiol* 60:1832, 1994.
- Moineau S, Borkaev M, Holler B, Walker S, Kondo J, Vedamuthu E, Vandenberg P. 1996. Isolation and characterization of lactococcal bacteriophages from cultured buttermilk plants in the United States. *J Dairy Sci* 79:2104, 1996.
- Moines M, Groux M, Horman I. La flaveur des fromages. 3. Mise en évidence de quelques constituants mineurs de l'arôme du Camembert. *Lait* 547:414, 1975.
- Monnet V, Condon S, Cogan TM, Gripon JC. Metabolism of starter cultures. In: Cogan TM, Accolas JP, eds. *Dairy Starter Cultures*. New York: VCH, 1996, p 47.
- Morgan ME. The chemistry of some microbially induced flavor defects in milk and dairy foods. *Biotechnol Bioeng* 18:953, 1976.
- Morgan S, Ross R, Hill C. Bacteriolytic activity caused by the presence of a novel lactococcal plasmid encoding lactococcin A, B and M. *Appl Environ Microbiol* 61:2995, 1995.
- Morgan S, Ross R, Hill C. Increasing starter cell lysis in cheddar cheese using a bacteriocin-producing adjunct. *J Dairy Sci* 80:1, 1997.
- Mossel D, Kleynen-Semmeling A, Vincentie H, Beerens H, Catsaras M. Oxytetracycline-glucose-yeast extract agar for selective enumeration of moulds and yeasts in foods and clinical material. *J Appl Bacteriol* 33:454, 1970.
- Muriana PM, Klaenhammer TR. Purification and characterization of lactacin F, a bacteriocin produced by *Lactobacillus acidophilus* 11088. *Appl Environ Microbiol* 57:114, 1991.
- Nakada M, Dosako S, Hirano R, Oaaka M, Nakajima I. Lactoperoxidase suppresses acid production in yogurt during storage under refrigeration. *Int Dairy J* 6:33, 1996.
- Neve H. Bacteriophage. In: Cogan TM, Accolas JP, eds. *Dairy Starter Cultures*. New York: VCH, 1996, p 157.
- Oberg CJ, Merrill RK, Moyes LV, Brown R, Richardson GH. Effects of *Lactobacillus helveticus* culture on physical properties of mozzarella cheese. *J Dairy Sci* 74:4101, 1991a.
- Oberg CJ, Wang A, Moyes LV, Brown R, Richardson GH. Effects of proteolytic activity of thermolactic cultures on physical properties of mozzarella cheese. *J Dairy Sci* 74:389, 1991b.
- Okello-Uma I, Marshall V. Influence of mastitis on growth of starter organisms used for the manufacture of fermented milks. *J Dairy Res* 53:631, 1986.
- Olivares J, Rua B, Susaeta I, Aldamiz-Echevarria P. Growth kinetics of several lactic acid bacteria useful as starter for ewe's cheese production. *Biotechnol Lett* 15:1071, 1993.
- Olson NF. The impact of lactic acid bacteria on cheese flavor. *FEMS Microbiol Rev* 87:131, 1990.
- Ord'Zez G, Jeon I. Evaluation of β -galactosidase activities associated with probiotic lactic

- acid bacteria by high performance liquid chromatography. *Cult Dairy Prod J* 30:29, 1995.
- O'Sullivan D, Coffey A, Fitzgerald GF, Hill C, Ross RP 1998. Design of a phage-insensitive lactococcal dairy starter via sequential transfer of naturally occurring conjugative plasmids. *Appl Environ Microbiol* 64:4618, 1998.
- Pacher B, Kniefel W. Development of a culture medium for the detection and enumeration of bifidobacteria in fermented milk products. *Int Dairy J* 6:43, 1996.
- Paired JC, Delorme F, Giraffa G, Commissaire J, Desmazeaud M. Evidence for a bacteriocin produced by *Lactococcus lactis* CNRZ 481. *Neth Milk Dairy J* 44:143, 1991.
- Pakkanen R, Aalto J. Growth factors and antimicrobial factors of bovine colostrum. *Int Dairy J* 7:285, 1997.
- Papathanasopoulos MA, Krier F, Revol-Junelles AM, Lefebvre G, Le Caer JP, Von Holy A, Hastings JW. Multiple bacteriocin production by *Leuconostoc mesenteroides* TA 33a and other *Leuconostoc/weisella* strain. *Current Microbiol* 35:331, 1997.
- Perry D, McMahon D, Oberg C. Effect of exopolysaccharide producing cultures on moisture retention in low fat mozzarella cheese. *J Dairy Sci* 80:799, 1997.
- Perry D, McMahon D, Oberg C. Manufacture of low fat mozzarella cheese using exopolysaccharide producing cultures. *J Dairy Sci* 81:563, 1998.
- Peterson LW. Buttermilk, sour cream, and related products. In: *Cultures for the Manufacture of Dairy Products*. Milwaukee: Chr. Hansen, Inc, 1997, p 101.
- Quiberoni A, Reinheimer JA. Physicochemical characterization of phage adsorption to *Lactobacillus helveticus* ATCC 15807 cells. *J Appl Microbiol* 85:762, 1998.
- Radke-Mitchell L, Sandine W. Associative growth and differential enumeration of *Streptococcus thermophilus* and *Lactobacillus bulgaricus*: a review. *J Food Prot* 47:245, 1984.
- Rajagopal SN, Sandine WE. Associative growth and proteolysis of *Streptococcus thermophilus* and *Lactobacillus bulgaricus* in skim milk. *J Dairy Sci* 73:894, 1990.
- Rammelsberg M, Radler F. Antibacterial polypeptides of *Lactobacillus* species. *J Appl Bacteriol* 69:177, 1990.
- Reddy M, Vedamuthu E, Washam C, Reinbold G. Agar medium for differential enumeration of lactic streptococci. *Appl Environ Microbiol* 24:947, 1972.
- Reinbold G, Swern M, Hussong R. 1953. A plating medium for the isolation and enumeration of enterococci. *J Dairy Sci* 36:1, 1953.
- Reiter B. Inhibition of lactic *Streptococcus* bacteriophage. *Dairy Ind* 21:877, 1956.
- Revol-Junelles AM, Lefebvre G. 1996. Purification and N-terminal amino acid sequence of dextranin 24, a bacteriocin of *Leuconostoc* sp. *Curr Microbiol* 33:136, 1996.
- Richard J, Kerhervé L. Influence of disinfectant residues on two methods of antibiotic detection in milk. *Rev Laitère Française* 306:127, 1975.
- Richardson GH. Proteinase negative cultures for cheese making. *Cult Dairy Prod J* 19:6, 1984.
- Riis S, Pedersen H, Sorensen N, Jakobsen M. Flow cytometry and acidification power test as rapid techniques for determination of the activity of starter cultures of *Lactobacillus delbrueckii* subsp. *bulgaricus*. *Food Microbiol* 12:245, 1995.
- Ryan M, Rea M, Hill C, Ross R. An application in cheddar cheese manufacture for a strain of *Lactococcus lactis* producing a novel broad-spectrum bacteriocin, lacticin 3147. *Appl Environ Microbiol* 62:612, 1996.

- Sahl HG. Pore formation in bacterial membranes by cationic lantibiotics. In: Jung G, Sahl HG, eds. Nisin and Novel Lantibiotics. Bad Honnef, Germany: Escom, Leiden, 1991, p 347.
- Sanders M. Genetic approaches for the improvement of strains for Italian cheese manufacture. A review. *J Dairy Sci* 74:3647, 1991.
- Sanders M, Leonhard P, Sing W, Klaenhammer T. Conjugal strategy for construction of fast acid-producing, bacteriophage-resistant lactic streptococci for use in dairy fermentations. *Appl Environ Microbiol* 52:1001, 1986.
- Sandine WE. Use of bacteriophage-resistant mutants of lactococcal starters in cheesemaking. *Neth Milk Dairy J* 43:211, 1989.
- Sandine WE. Commercial production of dairy starter cultures. In: Cogan TM, Accolas JP, eds. *Dairy Starter Cultures*. New York: VCH, 1996, p 191.
- Savat-Brunaud D, Thierry A, Manubois J. Development of a medium simulating Emmental juice for propionibacteria growth. *J Dairy Res* 64:573, 1997.
- Schiffmann AP, Schutz M, Wiesner HU. False negative and positive results in testing for inhibitory substances in milk. 1. The influence of antibiotics residues in bulk milk on lactic acid production of starter cultures. *Milchwissenschaft* 47:712, 1992.
- Schillinger U, Chung HS, Keppler K, Holzapfel WH. Use of bacteriocinogenic lactic acid bacteria to inhibit spontaneous nisin-resistant mutants of *Listeria monocytogenes* Scott A. *J Appl Microbiol* 85:657, 1998.
- Schleifer KH, Kraus J, Dvorak C, Kilpper-Balz R, Collins MD, Fischer W. Transfer of *Streptococcus lactis* and related streptococci to the genus *Lactococcus* gen. nov. *System Appl Microbiol* 6:183, 1985.
- Sechaud L, Cluzel PJ, Rousseau M, Baumgertner A, Accolas JP. Bacteriophages of lactobacilli. *Biochimie* 70:401, 1988.
- Shearman C, Jury K, Gasson M. Autolysis of *Lactococcus lactis* expressing a lactococcal bacteriophage gene. *Biotechnology* 10:196, 1992.
- Shimizu-Kadota M, Sakurai T, Tsuchida N. Prophage origin of a virulent phage appearing on fermentations of *Lactobacillus casei* S-1. *Appl Environ Microbiol* 45:669, 1983.
- Sing WD, Klaenhammer TR. A strategy for rotation of different bacteriophage defences in a lactococcal single strain starter culture system. *Appl Environ Microbiol* 59:365, 1993.
- Sodini I, Lagace L, Lacroix C, Corrieu G. Effect of continuous prefermentation of milk with an immobilized cell bioreactor on fermentation kinetics and curd properties. *J Dairy Sci* 81:631, 1998.
- Sozzi PD. Calcium requirements of lactic starter phages. *Milchwissenschaft* 27:503, 1972.
- Spinnler H, Corrieu G. Automatic method to quantify starter activity based on pH measurement. *J Dairy Res* 56:755, 1989.
- Stadhouders J, Hup G, Jansen LA. A study of optimum conditions of freezing and storing concentrated mesophilic starters. *Neth Milk Dairy J* 25:229, 1971.
- Stiles M. Bacteriocins produced by *Leuconostoc* species. *J Dairy Sci* 77:2718, 1994.
- Stiles M, Holzapfel W. 1997. Lactic acid bacteria of foods and their current taxonomy. *Int J Food Microbiol* 36:1, 1997.
- Strauss K. American-type cheeses. In: *Cultures for the Manufacture of Dairy Products*. Milwaukee: Chr. Hansen, Inc 1997, p 65.
- Tagg JR, Dajani AS, Wannamaker LW. Bacteriocins of gram-positive bacteria. *Bacteriol Rev* 40:722, 1976.

- Tahara T, Kanatani K. 1996. Isolation, partial characterization and mode of action of acidocin J1229, a bacteriocin produced by *Lactobacillus acidophilus* JCM 1229. *J Appl Bacteriol* 81:669, 1996.
- Tamime A, Deeth H. Yogurt: technology and biochemistry. *J Food Prot* 43:939, 1980.
- Terraghi E, Sandine W. 1975. Improved medium for lactic streptococci and their bacteriophages. *Appl Microbiol* 29:807, 1975.
- Teuber M, Lembke J. The bacteriophages of lactic acid bacteria with emphasis on genetic aspects of group N lactic streptococci. *Antonie van Leeuwenhoek* 49:283, 1983.
- Thunell RK. pH-controlled starter: a decade reviewed. *Cult Dairy Prod J* 23(3):10, 1988.
- Thunell RK. Taxonomy of the leuconostocs. *J Dairy Sci* 78:2514, 1995.
- To B, Etzel M. Spray drying, freeze drying, or freezing of three different lactic acid bacteria species. *J Food Sci* 62:576, 1997.
- Toba T, Yoshioka E, Itoh T. Lacticin, a bacteriocin produced by *Lactobacillus delbrueckii* subsp. *lactis*. *Lett Appl Microbiol* 12:43, 1990.
- Trepanier G, Simard RE, Lee BH. Lactic acid bacteria relation to accelerated maturation of cheddar cheese. *J Food Sci* 56:1238, 1991.
- Tsai K, Luedecke L. Impedance measurement of changes in activity of lactic cheese starter culture after storage at 4°C. *J Dairy Sci* 72:2239, 1989.
- Turner KW, Martley FG, Gilles J, Morris HA. Swiss-type cheese III. The effect on cheese moisture of varying the rate of acid production by *S. thermophilus*. *NZ J Dairy Sci Technol* 18:125, 1983.
- Ustunol Z, Hicks CL. Use of an enzyme-treated, whey-based medium to reduce culture agglutination. *J Dairy Sci* 77:1479, 1994.
- Ustunol Z, Sypien C. Determining lactococcal agglutination by ELISA. *J Food Sci* 61:1035, 1996.
- Valladao M, Sandine WE. Standardized method for determining the effect of various antibiotics on lactococcal cultures. *J Food Prot* 57:235, 1994a.
- Valladao M, Sandine WE. Quaternary ammonium compounds in milk: detection by reverse phase high performance liquid chromatography and their effect on starter growth. *J Dairy Sci* 77:1509, 1994b.
- Vandenbergh PA. Lactic acid bacteria: their metabolic products and interference with microbial growth. *FEMS Microbiol Rev* 12:221, 1993.
- Vaughan E, Pridmore R, Mollet B. Transcriptional regulation and evolution of lactose genes in the galactose-lactose operon of *Lactococcus lactis* NCDO2054. *J Bacteriol* 180:4893, 1998.
- Vedamuthu ER. The dairy leuconostocs: use in dairy products. *J Dairy Sci* 77:2725, 1994.
- Vedamuthu E, Reinbold G. The use of candle oats jar incubation for the enumeration, characterization, and taxonomic study of propionibacteria. *Milchwissenschaft* 22:428, 1967.
- Villani F, Pepe O, Mauriello G, Salzano G, Moschetti G, Coppola S. Antilisterial activity of thermophilin 347, a bacteriocin produced by *Streptococcus thermophilus*. *Int J Food Microbiol* 25:179, 1995.
- Visser S, Hop G, Exterkate FA, Stadhouders J. Bitter flavour in cheese. 2. Model studies on the formation and degradation of bitter peptides by proteolytic enzymes from calf rennet, starter cells, and starter cell fractions. *Neth Milk Dairy J* 37:169, 1983.
- Ward DJ. Characterization of a bacteriocin produced by *Streptococcus thermophilus* ST134. *Appl Microbiol Biotechnol* 43:330, 1995.

- Weinbrenner D, Barefoot S, Grinstead D. Inhibition of yogurt starter cultures by jensenin G, a *Propionibacterium* bacteriocin. *J Dairy Sci* 80:1246, 1997.
- Whitehead HR, Cox GA. The occurrence of bacteriophage in cultures of lactic streptococci. *N Z J Dairy Sci Technol* 16:319–320, 1935.
- Whitehead WE, Ayres JW, Sandine WE. A review of starter media for cheese making. *J Dairy Sci* 76:2344, 1993.
- Wolfson LM, Sumner SS. Antibacterial activity of the lactoperoxidase system: a review. *J Food Prot* 56:887, 1993.
- Wright A, Tynkkynem S. Construction of *Streptococcus lactis* subsp. *lactis* strains with a single plasmid associated with mucoid phenotype. *Appl Environ Microbiol* 53:1385, 1987.
- Yang NL, Sandine WE. Acid producing activity of lyophilized streptococcal cheese starter concentrates. *J Dairy Sci* 62:908, 1979.
- Yun JJ, Barbano DM, Keily L, Kindstedt PS. Mozzarella cheese: impact of rod:coccus ratio on composition, proteolysis, and functional properties. *J Dairy Sci* 78:751, 1995.

7

Metabolism of Starter Cultures

Robert W. Hutkins

*University of Nebraska
Lincoln, Nebraska*

I. INTRODUCTION

For most dairy fermentations, the role of starter culture bacteria is quite simple—they ferment lactose and produce lactic acid. As a result, the pH is reduced, and the ensuing low pH serves to preserve the product. In addition, lactic acid and low pH also are responsible for enhancing syneresis in cheese manufacture and for causing caseins to coagulate in yogurt, sour cream, and other cultured dairy products. However, lactic acid bacteria used as dairy starter cultures perform a number of other important functions in fermented milk products. They produce or generate several flavor compounds or flavor precursors, and they produce enzymes and other products that have profound effects on texture and body characteristics of cheese and cultured milk products. Not surprisingly, many functions performed by starter culture organisms are directly related to metabolic and physiological characteristics of those organisms. In this chapter, the specific means by which carbohydrates and proteins are metabolized and how endproducts are produced by lactic acid bacteria will be reviewed. The pathways for flavor production, not only by lactic acid bacteria but also by non-lactic acid bacteria used as culture adjuncts and by fungi will also be described.

II. CARBOHYDRATE UTILIZATION BY LACTIC ACID BACTERIA

Lactic acid bacteria are classified as heterotrophic chemoorganotrophs, meaning that they require preformed organic carbon as a source of both carbon and energy.

Lactic acid bacteria also lack cytochrome or electron transport proteins, and therefore cannot derive energy via respiratory activity. Thus, substrate-level phosphorylation reactions that occur during glycolysis (see below) are the primary means by which ATP is obtained. There are, however, other means by which these organisms can conserve energy and save ATP that would ordinarily be used to perform necessary functions, such as nutrient transport (see below).

Although there are some important differences between how various genera and species use and metabolize specific carbohydrates, lactic acid bacteria generally lack metabolic diversity and instead rely on two principal pathways for catabolism of carbohydrates. In the homofermentative pathway, hexoses are metabolized via enzymes of the Embden-Meyerhoff pathway (Fig. 1), yielding 2 mol of pyruvate and 2 mol of ATP per mole of hexose. Pyruvate is subsequently reduced to lactate by lactate dehydrogenase, so that more than 90% of the starting material (i.e., glucose) is converted to lactic acid. The NADH formed via the glyceraldehyde-3-phosphate dehydrogenase reaction is also reoxidized (forming NAD^+) by lactate dehydrogenase, thus maintaining the NADH/ NAD^+ balance. Among lactic acid bacteria used as dairy starter cultures, most are homofermentative, including *Lactococcus lactis*, *Streptococcus thermophilus*, *Lactobacillus helveticus*, and *Lb. delbrueckii* subsp. *bulgaricus*.

In heterofermentative metabolism, hexoses are catabolized by the phosphoketolase pathway (Fig. 2), which results in approximate equimolar production of lactate, acetate, ethanol, and CO_2 . Only 1 mol of ATP is made per hexose. In actuality, however, product yields for both homo- and heterofermentative metabolism can vary, depending on the source and amount of available substrate, growth temperature, atmospheric conditions, and other factors. Under certain conditions, for example, some homofermentative organisms can divert pyruvate away from lactate and toward other so-called “heterolactic” endproducts (see below). Importantly, the pathway used by a particular strain or culture may have a profound effect on flavor, texture, and overall quality of fermented dairy products. Although several species of *Lactobacillus* are heterofermentative, *Leuconostoc* spp. are the only heterofermentative lactic acid bacteria used as starter cultures in dairy products.

A. Metabolism of Lactose by Lactic Acid Bacteria

As described earlier, lactic acid bacteria generally rely on either the Embden-Meyerhoff or phosphoketolase pathway for metabolism of sugars. In fact, these catabolic pathways are only a part of the overall metabolic process used by these bacteria. The first, and perhaps most important, step in carbohydrate metabolism involves transport of the sugar substrate across the cytoplasmic membrane and its subsequent accumulation in the cytoplasm. This process of transport and accu-

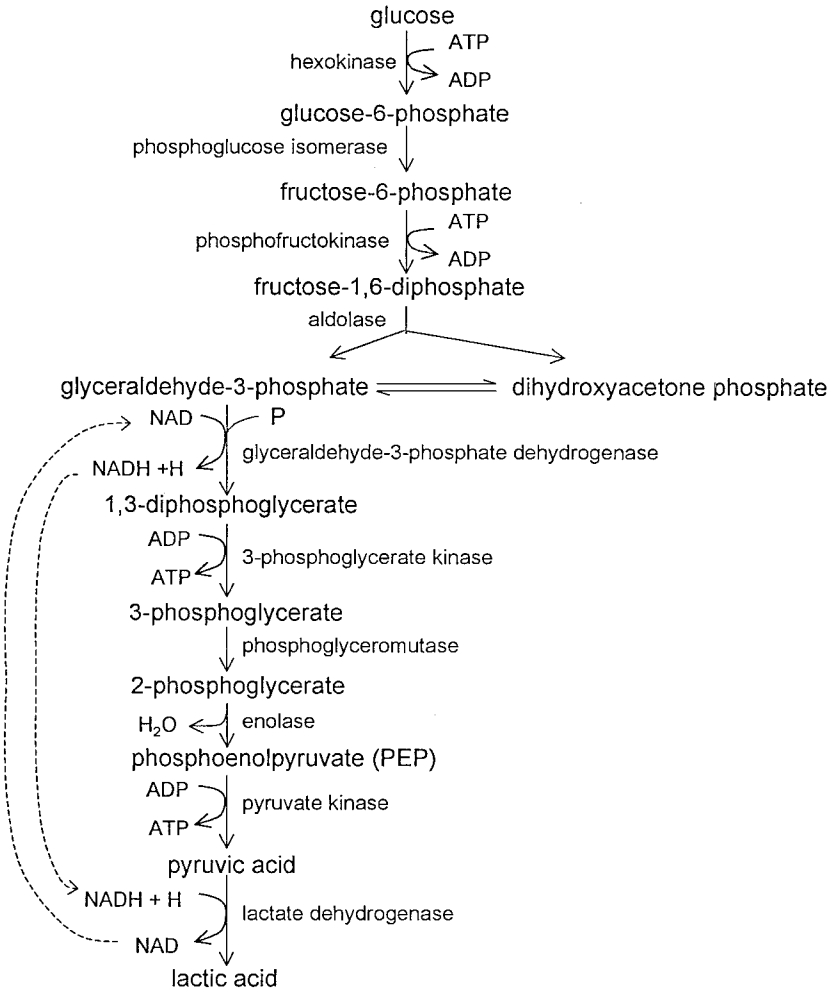

Figure 1 The Embden-Meyerhoff pathway used by homofermentative lactic acid bacteria.

mulation is important for several reasons. First, active transport of sugars requires energy, and much of the energy gained by cells as a result of catabolism must then be used to transport more substrate. Second, the transport system used by a particular strain dictates, in part, the catabolic pathway used by that organism. The transport machinery also plays a regulatory role and can influence expression

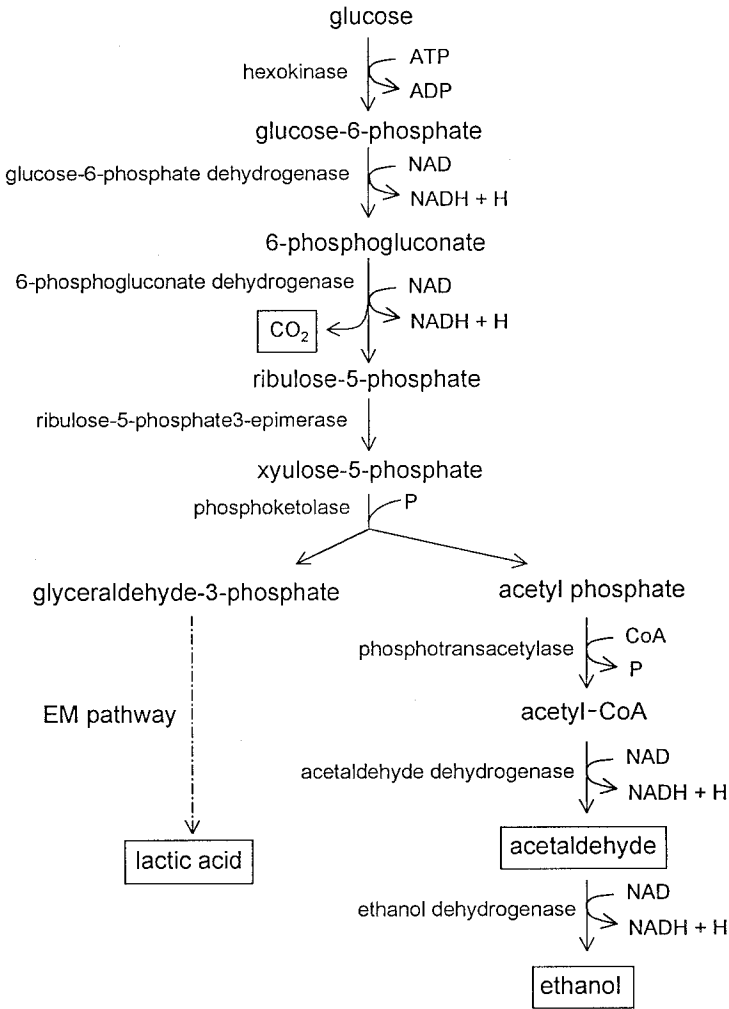

Figure 2 The phosphoketolase pathway used by heterofermentative lactic acid bacteria.

of alternative transport systems. Finally, the metabolic behavior of a particular strain and how that strain functions in fermented dairy foods may be influenced by the actual operation of the transport system itself.

B. Lactose Phosphotransferase System of *Lc. lactis*

There are, in general, two different systems used by lactic acid bacteria to transport carbohydrates, and it is convenient to group lactic acid bacteria according to the system used to transport their primary substrate, lactose. The phosphoenolpyruvate (PEP)-dependent phosphotransferase system (PTS) is used by most mesophilic, homofermentative lactic acid bacteria, especially lactococci used as starter cultures for cottage, Cheddar, Gouda, and other common cheese varieties. In contrast, other starter culture bacteria, such as *S. thermophilus* and *Lactobacillus* spp. that are used for yogurt, Swiss, and mozzarella cheese production, transport lactose via a lactose permease. Dairy *Leuconostoc* bacteria also rely on a lactose permease for uptake of lactose. Some lactococci and lactobacilli have the ability to use both systems. Not only do these two systems differ in biochemical characteristics, but energy sources used to drive transport and accumulated intracellular products differ as well. These differences have practical implications.

The *Lactococcus* lactose PTS, first described by McKay et al. (1969), consists of a cascade of cytoplasmic and membrane-associated proteins that transfer a high-energy phosphate group from its initial donor, PEP, to the final acceptor molecule, lactose. Phosphorylation of lactose occurs concurrent with the vectorial movement of lactose across the cytoplasmic membrane (from out to in) and results in intracellular accumulation of lactose phosphate. As shown in Figure 3, there are two cytoplasmic proteins, enzyme I and histidine-containing protein (HPr), that are nonspecific and function as the initial phosphorylating proteins for all PTS substrates. The substrate-specific PTS components comprise the enzyme II complex, which for the lactose PTS in *Lc. lactis*, represents three protein domains (Enz IIA^{lac} and Enz IIBC^{lac}). The phosphoryl group is transferred first from PEP to enzyme I, then to HPr, then to the cytoplasmic protein, Enz IIA^{lac}, which then transfers it to the cytoplasmic domain of Enz IIBC^{lac}. As lactose is translocated across the membrane by the integral membrane domain of Enz IIBC^{lac}, it becomes phosphorylated.

The product of the lactose PTS, thus, is lactose-phosphate, or more specifically, glucose- β -1,4-galactosyl-6-phosphate. Hydrolysis of this compound occurs via phospho- β -galactosidase, yielding glucose and galactose-6-phosphate. Glucose is phosphorylated by hexokinase (via an ATP) to glucose-6-phosphate, which then feeds directly into the Embden-Meyerhoff pathway, as described earlier. Galactose-6-phosphate, in contrast, takes a different route altogether, as it is first isomerized to tagatose-6-phosphate and then phosphorylated to form tagatose-1,6-diphosphate (Fig. 4). The latter is then split by tagatose-1,6-diphosphate

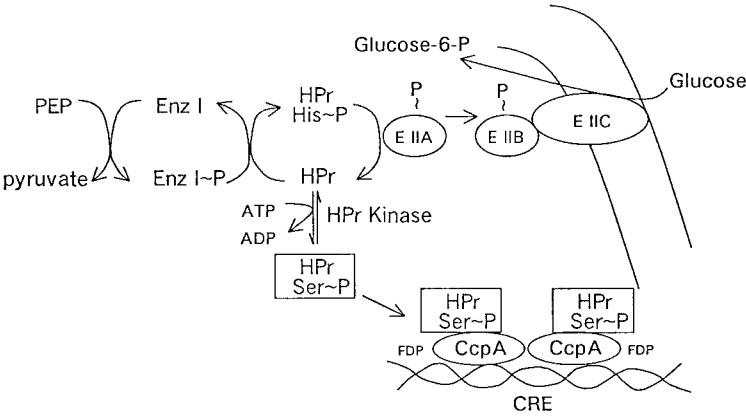

Figure 3 Signal transduction and the phosphotransferase system in gram-positive bacteria. HPr can be phosphorylated at His-15 (by Enz I) or at Ser-46 by an HPr kinase. The latter, along with CcpA and fructose diphosphate (FDP), form a complex that recognizes CRE sites and prevents transcription of catabolic genes. (Adapted from Saier et al., 1995.)

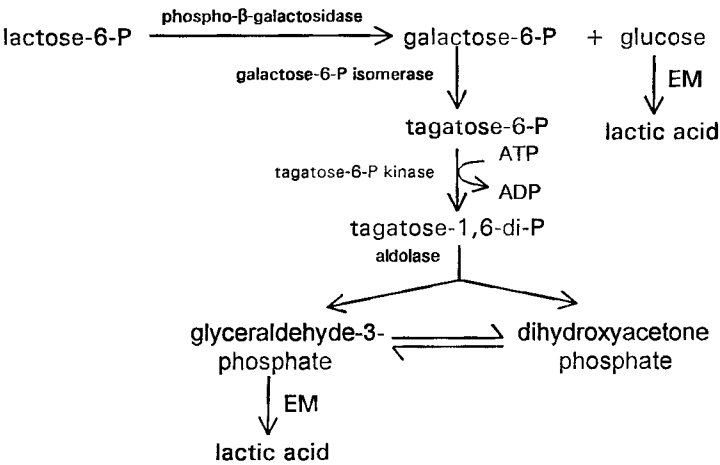

Figure 4 Tagatose pathway in lactococci. Galactose-6-phosphate is formed from hydrolysis of lactose-phosphate, the product of the lactose PTS. Isomerization and phosphorylation form tagatose-1, 6-diphosphate, which is split by an aldolase, yielding the triose phosphates that feed into the EM pathway.

aldolase to form the triose phosphates, glyceraldehyde-3-phosphate and dihydroxyacetone phosphate, in a reaction analogous to the aldolase of the Embden-Meyerhoff pathway. It is important to note that in *Lc. lactis*, glucose and galactose moieties of lactose, despite taking parallel pathways, are fermented simultaneously.

C. Regulation of the Phosphotransferase System

In *Lc. lactis*, lactose fermentation is regulated at several levels. First, several glycolytic enzymes are allosteric, and their activities are therefore influenced by the intracellular concentration of specific glycolytic metabolites via feedback inhibition. During active lactose metabolism (i.e., when lactose is plentiful), the high intracellular concentration of fructose-1,6-diphosphate (FDP) and low level of inorganic phosphate stimulate pyruvate kinase. Thus, much of the PEP made via glycolysis is used to drive ATP synthesis, which is consistent with a period of active cell growth. The activity of the NADH-dependent lactate dehydrogenase is also stimulated, which is important because reduced NAD⁺, formed via the glyceraldehyde-3-phosphate dehydrogenase reaction, must be reoxidized to maintain the NAD⁺/NADH balance. In contrast, when lactose is limiting, pyruvate kinase activity decreases causing PEP to accumulate, which forms a “bottleneck” in glycolysis. The concentration of triose phosphates subsequently increases, forming a pool of PEP equivalents. Thus, during a period when lactose is unavailable, a PEP “potential” exists, poisoning the cell for when lactose is available (Thompson, 1987).

A second and more effectual mechanism for controlling or regulating lactose metabolism is exerted at the level of the transport machinery itself. In particular, the phosphorylation state of HPr, the cytoplasmic PTS phosphocarrier protein, plays a major role in sugar metabolism. As noted earlier, HPr is phosphorylated by enzyme 1. This phosphorylation occurs specifically at the histidine-15 (His-15) residue of HPr. However, HPr can also be phosphorylated at a serine residue (Ser-46) by an ATP-dependent HPr kinase, which is activated by fructose-1,6-diphosphate (as would occur during active sugar metabolism). When HPr is in this state, that is, HPr (Ser-46-P), phosphorylation at His-15 is inhibited; thus, PTS activity is also inhibited and entry of other potential PTS substrates is prevented. Additional experimental evidence that HPr (Ser-46-P) can directly inhibit transport of sugars was provided by Saier and coworkers (Ye and Saier, 1995a, 1995b; Ye et al., 1994), who showed that HPr (Ser-46-P) can bind to or otherwise inactivate sugar permeases, a process known as inducer exclusion. Yet another means by which HPr (Ser-46-P) regulates sugar flux is via inducer expulsion. Presumably, this occurs when sugar phosphates have accumulated intracellularly beyond the rate at which metabolism can occur or when nonmetabolizable sugars have been taken up. Since these sugar phosphates could inhibit metabolism, they

must first be dephosphorylated and then effluxed. In inducer expulsion, therefore, HPr (Ser-46-P) activates a sugar-specific phosphatase that dephosphorylates the sugar phosphates so that efflux of the free sugar can then occur (Thompson and Chassy, 1983).

HPr not only exerts biochemical control on transport, but HPr (Ser-46-P) also plays an important role at the gene level through its interaction with the DNA-binding protein, CcpA, or catabolite control protein A. As illustrated in Figure 3, HPr (Ser-46-P) and CcpA (with the participation of fructose-1,6-diphosphate) affect metabolism by blocking transcription of catabolic genes, including other PTS genes, a process called catabolite repression. CcpA or CcpA-like proteins appear to be widely distributed among gram-positive bacteria, including several species of lactic acid bacteria (Luesink et al., 1998a), and this mechanism of gene regulation, therefore, may be common. According to this model of carbon source-mediated gene regulation, HPr exists in one of two phosphorylation states, HPr (His-15-P) or HPr (Ser-46-P). The former accumulates when lactose (or another PTS sugar, such as glucose) is unavailable, since the enzyme II complex is without its substrate. In contrast, when lactose is available and the energy state of the cell is high, intracellular FDP levels increase and HPr kinase is activated, causing HPr (Ser-46-P) to accumulate. A complex is then formed between HPr (Ser-46-P) and CcpA. This complex, along with a glycolytic activator (fructose-1,6-diphosphate or glucose-6-phosphate), binds to 14-base pair DNA regions called catabolite responsive elements (CREs) located near the transcription start sites of catabolic genes. When these CRE regions are occupied by the HPr (Ser-46-P)-CcpA complex, transcription by RNA polymerase is effectively blocked or reduced. In contrast, mutations in *ccpA* or deletions of *cre* regions eliminate catabolite repression. Since CRE regions are found in the promoter regions of several catabolic genes, the phosphorylation status of HPr can have a profound effect on whether these genes are expressed. Identified gene clusters preceded by CRE regions in lactococci include genes coding for galactose (and thus lactose) and sucrose metabolism. For example, when *Lc. lactis* is grown on glucose, a PTS substrate, transcription of genes coding for galactose metabolism is repressed (Luesink et al., 1998b). Even the presence of galactose fails to induce expression of *gal* genes as long as glucose, the repressing sugar, is present.

Not only does HPr have a negative regulatory role, but it was recently shown that HPr (Ser-46-P) and CcpA can also activate gene expression (Luesink et al., 1998b, 1999). Specifically, expression of the *las* operon, coding for lactate dehydrogenase, phosphofructokinase, and pyruvate kinase, is activated at high sugar conditions. The net effect, therefore, is that the phosphorylation state of HPr serves as a signal for activating expression of genes coding for glycolytic enzymes when the cell is actively metabolizing sugars. Recent genetic evidence (Luesink et al., 1999) indicates that HPr is also important in influencing sugar

uptake by establishing a hierarchy for different sugars preferentially fermented by *Lc. lactis*.

Finally, lactose metabolism is also genetically regulated via expression and repression of the lactose PTS genes (Fig. 5). The lactose metabolism genes in *Lc. lactis*, like the genes coding for other important metabolic pathways, are often located on plasmids of varying size. Strains cured of the lactose plasmid, which encodes lactose metabolism genes, are unable to ferment lactose. In *Lc. lactis* MG1820, the *lac* genes are organized as an 8-kb operon, consisting of eight genes in the order *lacABCDFEGX* (de Vos et al., 1990). The first four genes, *lacABCD*, actually code for enzymes of the tagatose pathway and are necessary for galactose utilization (see below). The lactose-specific genes, *lacFEG*, code for PTS proteins and phospho- β -galactosidase. The operon is negatively regulated by LacR, a repressor protein encoded by the *lacR* gene, which is located upstream of the *lac* promoter and which is divergently transcribed (van Rooijen and de Vos, 1990). In the presence of lactose, *lacR* expression is repressed, and transcription of the *lac* operon is induced. During growth on glucose or when lactose is unavailable (and cells are uninduced), LacR is expressed and transcription of the *lac* genes is repressed. A CRE site is also located near the transcriptional start site of the *lac* operon. However, when *lacR* is inactivated, expression of *lac* genes becomes constitutive regardless of carbon source (i.e., under conditions that presumably would activate CcpA-mediated repression). This implies that LacR, along with inducer expulsion-exclusion, have primary responsibility for regulating sugar metabolism, rather than CcpA, and that catabolite repression in lactococci is mediated mainly via the concentration of inducer (Luesink et al., 1998).

The lactose PTS, as described earlier for *Lc. lactis*, also exists in other dairy lactic acid bacteria, including *Lb. casei*. However, in *Lb. casei*, *lac* genes are chromosomally encoded and the nucleotide sequence and genetic organization are different from those in *Lc. lactis* (Gosalbes et al., 1997). The *Lb. casei lac*

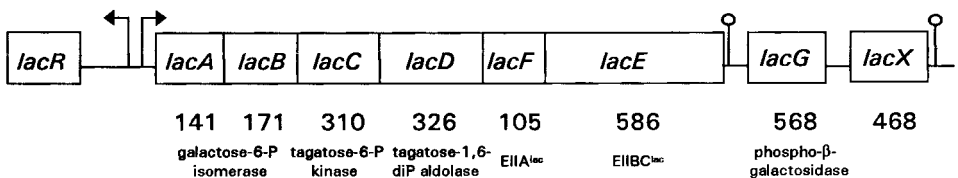

Figure 5 The *lac* operon in lactococci. The first four structural genes (*lacABCD*) code for enzymes of the tagatose pathway, *lacFE* code for lactose-specific PTS proteins, and *lacG* codes for phospho- β -galactosidase. The divergently transcribed *lacR* codes for a repressor; the function of *lacX* is not known. Promoter sites and directions are shown by arrows, and potential transcriptional terminators are shown as hairpin loops. The number of amino acids for each protein is given. (Adapted from de Vos et al., 1990.)

cluster (*lacTEGF*) encodes, respectively, for a regulatory protein, two PTS proteins, and phospho- β -galactosidase. Genes coding for galactose metabolism (*lacABCD* in *Lc. lactis*) are absent in the *Lb. casei lac* cluster. Although expression of *lac* genes is repressed by a CcpA-mediated process, as in *Lc. lactis*, an additional regulatory mechanism dependent on an antiterminator also exists in *Lb. casei* (Gosalbes et al., 1999).

D. Lactose Transport and Hydrolysis by *S. thermophilus*

Although the PTS is widely distributed among lactic acid bacteria, several important dairy species rely on a lactose permease for transport and a β -galactosidase for hydrolysis. Some species have both pathways for lactose, and some have a PTS for one sugar and a permease for another. The best example of the lactose permease/ β -galactosidase system is that which occurs in *S. thermophilus*, *Lb. helveticus*, and *Lb. delbruecki* subsp. *bulgaricus* (Fig. 6). In these bacteria, lactose accumulates in an unmodified form via the LacS permease. A similar system also exists in some strains of *Lc. lactis*, but clearly it is not the primary system. The lactose permease in *S. thermophilus* is dramatically different from other, well-studied lactose permeases, such as the LacY system in *Escherichia coli*. In *E. coli*, lactose transport is fueled by a proton motive force (PMF), and the permease binds and transports its substrate lactose in symport with a proton. In *S. thermophilus*, lactose transport can also be fueled by a PMF, but that is not the main way the permease can function. Instead, the transporter has exchange or

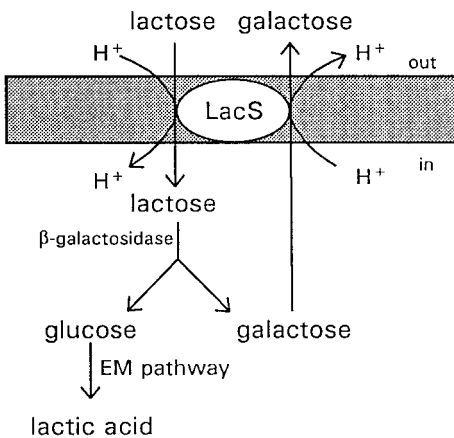

Figure 6 Lactose transport and hydrolysis by *S. thermophilus*. Lactose uptake is driven by galactose efflux; both solutes may be transported in symport with a proton.

antiporter activity, so that lactose uptake can be driven by efflux of galactose. That is, “uphill” lactose transport (uptake against a concentration gradient) occurs as a result of “downhill” galactose efflux (Hutkins and Ponne, 1991). Since generation of a PMF requires ATP (or its equivalent), not having to use the PMF for lactose uptake conserves energy. The lactose:galactose exchange reaction is actually quite remarkable, in that, as discussed below, galactose efflux, rather than galactose utilization, appears to be the preferred pathway for most strains of *S. thermophilus*. Why this phenomenon occurs and the important practical implications for this will be discussed later.

Detailed analysis of the *S. thermophilus* LacS system has revealed that the permease protein itself is a hybrid consisting of two distinct regions or domains (Poolman et al., 1989). The deduced amino acid sequence of the amino-terminal region is very similar to the melibiose permease of *E. coli*. However, the carboxy-terminal region is structurally similar to an *E. coli* PTS enzyme IIA domain. In fact, this enzyme IIA-like domain can be phosphorylated by HPr, reducing transport activity of LacS. It now appears that the permease region functions as the lactose carrier and the enzyme IIA-like domain functions as a regulatory unit.

Hydrolysis of lactose in *S. thermophilus* occurs via a β -galactosidase that has modest amino acid homology to other LacZ-like enzymes (30–50%). After hydrolysis, *S. thermophilus* rapidly ferments glucose to lactic acid by the Embden-Meyerhoff pathway, yet most strains, especially those used as dairy starter cultures, do not ferment the galactose moiety of lactose. Rather, galactose is effluxed and accumulates in the extracellular medium. In the manufacture of dairy products made with an *S. thermophilus*-containing culture, such as yogurt or mozzarella cheese, galactose may appear in the finished product. With yogurt, accumulated galactose is of little consequence, but for mozzarella cheese, even a small amount of galactose can present problems. This is because of the nonenzymatic browning reaction that occurs when galactose, a reducing sugar, is heated in the presence of free amino acids. Since most mozzarella cheese is used for pizzas, high-temperature baking accelerates nonenzymatic browning reactions. Cheese containing galactose can brown excessively, a phenomenon considered as a defect by many pizza manufacturers. Therefore, mozzarella producers may be asked by their customers to satisfy specifications for “low-browning” or low-galactose cheese. Although some cheese manufacturers can rely on their cheese-making know-how and simply modify the production procedures to remove unfermented galactose, other manufacturers have chosen to use cultures that have low-browning potential, as described below.

Why are most strains of *S. thermophilus* phenotypically galactose negative (Gal⁻) and unable to ferment either free or lactose-derived galactose? Evidence from several laboratories indicates that *S. thermophilus* does contain genes necessary for galactose metabolism (see below), but that these genes are not ordinarily expressed even under inducing conditions. Mutants have been isolated, however,

that ferment free galactose, but when these strains are grown on lactose, galactose utilization is still repressed (Thomas and Crow, 1984, Benateya et al., 1991). Thus, it has been suggested that of the two routes that galactose can take, the efflux reaction is favored over the catabolic pathway.

E. Lactose Metabolism by *Lactobacillus* and Other Lactic Acid Bacteria

Most other lactic acid bacteria rely on one or the other of the two pathways described earlier. Table 1 lists the pathways used by species that have been studied in sufficient detail. With the exception of *Lc. lactis* and *Lb. casei*, however, most dairy lactic acid bacteria do not have a lactose PTS, and instead use a lactose permease/ β -galactosidase system for metabolism of lactose. Some strains have more than one system; for example, *Lc. lactis* and *Lb. casei* have both a lactose PTS and a lactose permease/ β -galactosidase. It is important to note that not all strains or species that use non-PTS pathways for lactose metabolism excrete galactose into the medium, as described for *S. thermophilus*. Many of the lactobacilli and *Leuconostoc* spp. that transport and hydrolyze lactose by a permease and a β -galactosidase, respectively, also ferment glucose and galactose simultaneously. This is important, because in almost all fermented dairy products made with a culture containing *S. thermophilus*, a galactose-fermenting *Lactobacillus* sp. is also present (see Chap. 11). For some products, such as Swiss-style cheeses, the galactose that is effluxed into the curd by *S. thermophilus* is subsequently fermented by *Lb. helveticus*. Otherwise, the free galactose could be fermented by other members of the microflora, resulting in heterofermentative endproducts that could contribute to off-flavors and other product defects.

F. Galactose Metabolism

During growth in milk, lactic acid bacteria ordinarily encounter free galactose only after intracellular hydrolysis of lactose. For lactococci and those lactobacilli

Table 1 Lactose Transport and Metabolic Systems in Dairy Lactic Acid Bacteria

Organism	Lactose transport system	Galactose pathway
<i>Streptococcus thermophilus</i>	Lac permease	Leloir
<i>Lactococcus lactis</i>	PTS	Leloir, tagatose
<i>Lactobacillus delbrueckii</i> subsp. <i>bulgaricus</i>	Lac permease	Leloir
<i>Lactobacillus helveticus</i>	Lac permease	Leloir
<i>Lactobacillus casei</i>	PTS, Lac permease	Leloir, tagatose
<i>Leuconostoc lactis</i>	Lac permease	Leloir

that transport lactose via the PTS, galactose-6-phosphate is the actual hydrolysis product (resulting from hydrolysis of lactose-phosphate by phospho- β -galactosidase). Galactose-6-phosphate feeds directly into the tagatose pathway, as described earlier and in Figure 4. However, as noted earlier, free galactose will appear and accumulate in fermented dairy products made with thermophilic starter cultures containing *S. thermophilus*, *Lb. bulgaricus*, or other galactose-nonfermenting strains. Yogurt and mozzarella cheese, for example, can contain up to 2.5 and 0.8% galactose, respectively. Therefore, metabolism of free galactose may be of practical importance.

For the lactococci and some lactobacilli, free galactose appears to be transported by either a galactose-specific PTS or by a galactose permease. The intracellular product of the galactose PTS (galactose-6-phosphate) simply feeds into the tagatose pathway. When galactose accumulates via galactose permease, the intracellular product is free galactose. Subsequent metabolism occurs via the Leloir pathway, which phosphorylates galactose, and then converts galactose-1-phosphate into glucose-6-phosphate (Fig. 7). The latter then feeds into the glycolytic pathway. Interestingly, in *Lc. lactis*, galactose permease may be the primary means for transporting galactose, since it has a much higher apparent affinity for galactose than the PTS transporter.

The Leloir pathway is used not only by lactococci, but it is also the pathway used by *Lb. helveticus*, *Leuconostoc* spp., and galactose-fermenting strains of *S. thermophilus*. During growth on lactose, these bacteria rely on a lactose

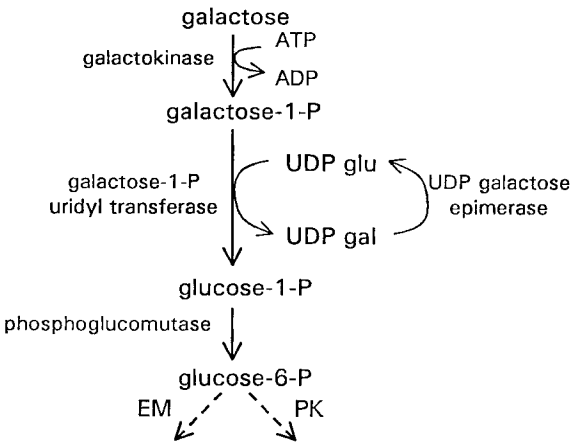

Figure 7 Leloir pathway in lactic acid bacteria. Phosphorylation of galactose may require isomerization by mutarotase (not shown). The subsequent steps convert galactose-1-phosphate into glucose-6-phosphate, which feeds into the EM pathway (homofermentative bacteria) or phosphoketolase (PK) pathway (heterofermentative bacteria).

permease/ β -galactosidase system and therefore generate free intracellular galactose. In some instances, they will also encounter free extracellular galactose, especially if they are grown in the presence of galactose-nonfermenting strains, as described earlier. Subsequent galactose fermentation by *Lb. helveticus* and *Leuconostoc lactis* occurs via the Leloir pathway. Transport is mediated by a permease, apparently driven by a PMF. A mutarotase (the product of the *galM* gene) may also be necessary to convert β -D-galactose (the product of lactose hydrolysis) to its anomeric isomer, α -D-galactose, before it can be efficiently phosphorylated by galactokinase.

Despite the inability of most strains of *S. thermophilus* to ferment galactose, genes coding for enzymes of the Leloir pathway appear to be present and functional (Grossiord et al., 1998; Poolman et al., 1990; Mustapha et al., 1995). The *S. thermophilus gal* operon consists of four structural genes (*galKTEM*) and one divergently transcribed regulatory gene (*galR*). Transcription of these genes, however, does not occur in most wild-type strains, accounting for the galactose nonfermenting phenotype. Mutations in the *gal* promoter/regulatory region led to isolation of galactose-fermenting mutants that expressed *gal* genes and fermented galactose. Such efforts suggest that genetic modification of *S. thermophilus* may provide the basis for obtaining stable galactose-fermenting derivatives that would be of considerable value to the dairy industry (de Vos, 1996).

Although the *gal* genes in *S. thermophilus*, *Leuc. lactis*, *Lc. lactis*, *Lb. casei*, and *Lb. helveticus* share significant amino acid sequence homology and are chromosomally encoded, they are organized in a somewhat different order (Grossiord et al., 1998). All contain *galK* (galactokinase), *galT* (galactose-1-phosphate uridyl transferase), and *galE* (UDP-galactose-4-epimerase), and some clusters also contain the *galM* gene coding for mutarotase. In *S. thermophilus*, the *gal* genes are located immediately upstream of the *lacS-lacZ* cluster. There is also rather significant variation with respect to genetic structure even between strains of the same species. For example, a *galA* gene, thought to encode for a permease, is the first gene in the *Lc. lactis* MG1363 *gal* cluster, but this gene does not appear in *gal* clusters from other organisms.

The ability of these strains, especially lactobacilli, to ferment galactose can be quite variable, and strain selection is important. Galactose fermentation by lactobacilli has also been used as a basis for distinguishing between *Lb. helveticus* (Gal⁺) and *Lb. delbrueckii* subsp. *bulgaricus* (Gal⁻). As noted earlier, some culture suppliers promote “nonbrowning” cultures for use in mozzarella cheese production; invariably, these cultures contain galactose-fermenting lactobacilli.

G. Alternate Routes for Pyruvate

As described earlier, lactic acid bacteria are ordinarily considered as being either homofermentative or heterofermentative, with some species being able to metab-

olize sugars by both pathways. However, sugar metabolism, even by obligate homofermentative strains, can result in formation of endproducts other than lactic acid by a variety of pathways (Fig. 8). In general, these alternative fermentation products are formed as a consequence of accumulation of excess pyruvate and the requirement of cells to maintain a balanced NADH/NAD⁺ ratio. That is, when the intracellular pyruvate concentration exceeds the rate at which lactate can be formed via lactate dehydrogenase, other pathways must be recruited not only to remove pyruvate but also to provide a means for oxidizing NADH. These alternative pathways may also provide cells with the means to make additional ATP. Under what conditions or environments would pyruvate accumulate? As noted earlier, when fermentation substrates are limiting, and the glycolytic activator, fructose-1,6-diphosphate, is in short supply, activity of the allosteric enzyme, lactate dehydrogenase, is reduced and pyruvate accumulates. Low carbon flux may also occur during growth on galactose or other less preferred carbon sources, resulting in excess pyruvate. When the environment is highly aerobic, NADH that would normally reduce pyruvate is instead oxidized directly by molecular oxygen and is unavailable for the lactate dehydrogenase reaction.

Several enzymes and pathways have been identified in lactococci and other lactic acid bacteria that are responsible for diverting pyruvate away from lactic acid and toward other products (Cocaign-Bousquet et al., 1996; Garrigues et al., 1997). In anaerobic conditions, and when carbohydrates are limiting and growth rates are low, a mixed-acid fermentation occurs, and ethanol, acetate, and formate are formed. Under these conditions, pyruvate-formate lyase is activated, and pyruvate is split to form formate and acetyl-CoA. Acetyl-CoA can be converted to ethanol and/or acetate. The latter also results in formation of an ATP via acetate

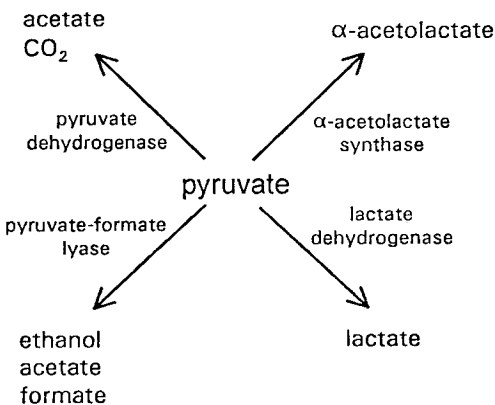

Figure 8 Alternative routes of pyruvate metabolism.

kinase. If the environment is aerobic, pyruvate-formate lyase is inactive, and instead pyruvate is decarboxylated by pyruvate dehydrogenase to form acetate and CO_2 . Finally, excess pyruvate can be diverted to α -acetylacetyl synthase. This reaction has other important implications, since α -acetylacetyl is the precursor for diacetyl formation.

Although these alternative pathways for pyruvate metabolism are influenced largely by environmental conditions, mutants unable to produce lactate dehydrogenase also must deal with excess pyruvate and, therefore, produce other endproducts. Under certain conditions, cells may divert excess pyruvate to highly desirable products, specifically the aroma compound diacetyl. Ordinarily diacetyl is made from citrate (see below), but even citrate-nonfermenting cells will make diacetyl from lactose if appropriate conditions are established or if cells are genetically modified. For example, overexpression of NADH oxidase in *Lc. lactis* decreases lactate formation from pyruvate, and instead α -acetylacetyl, the precursor for diacetyl, is formed (de Felipe et al., 1998). Enhancing diacetyl production by metabolic engineering will be discussed later.

III. PROTEIN METABOLISM

Just as dairy lactic acid bacteria are well suited to utilize lactose as a source of energy and carbon, they are also well adapted to use casein as a source of nitrogen. Lactic acid bacteria cannot assimilate inorganic nitrogen and, therefore, they must be able to degrade proteins and peptides to satisfy their amino acid requirements. The absolute requirement for a system to degrade milk casein was first demonstrated by McKay and Baldwin (1974), who showed that *Lc. lactis* C2, cured of a plasmid containing the proteinase gene, was unable to grow to high cell density in milk. However, if milk was supplemented with hydrolyzed milk protein, the plasmid-cured strain grew like the parental strain. We now know that dairy lactic acid bacteria have evolved highly efficient systems for reducing large casein subunits to smaller pieces and for supplying cells with all of the amino acids necessary for growth in milk. The proteolytic system consists of three main components. The first involves the proteolysis of casein to form a large collection of peptides. In the second step, peptides are transported into cells by one of several transport systems. Once inside the cell, peptides are further hydrolyzed by a diverse group of peptidases to form free amino acids which are ultimately either metabolized or assimilated into protein (Fig. 9).

A. Proteinase System

Although lactic acid bacteria vary considerably in their ability to degrade milk protein, most organisms possess similar systems, as typified by the extensively

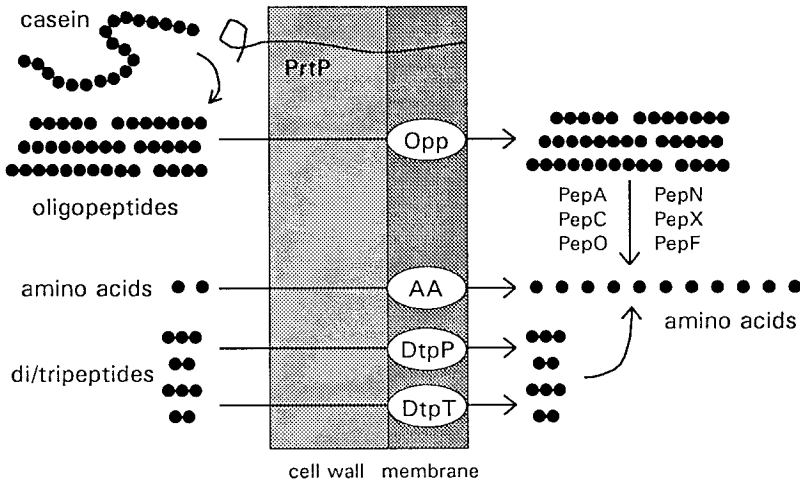

Figure 9 Proteolytic system in lactococci. Milk casein is hydrolyzed by cell envelope-associated proteinase (PrtP) to form oligopeptides, which are transported across the membrane by the oligopeptide transport system (Opp). Intracellular oligopeptides are then hydrolyzed by a variety of peptidases (PepA, PepC, PepF, PepO, and PepX) to form amino acids. Dipeptides and tripeptides and free amino acids, also present in milk, are transported by dipeptide tripeptide transporters (DtpT, DtpP) and amino acid (AA) transporters. Dipeptides and tripeptides are further hydrolyzed to amino acids. (Adapted from Mierau et al., 1997 and Steele, 1998.)

studied proteolytic system of *Lactococcus*. For *Lc. lactis* and other dairy lactic acid bacteria, casein is the primary source of amino acid nitrogen, since the non-protein nitrogen and free amino acids available in milk (<300 mg/L) are quickly depleted. Because *Lc. lactis* is a multiple amino acid auxotroph and requires as many as eight amino acids, casein hydrolysis is essential. Casein utilization by *Lc. lactis* begins with elaboration of a cell envelope-associated serine proteinase. This proteinase, PrtP, is expressed as a large (>200 kD), inactive preproproteinase. The leader sequence, which is responsible for directing the protein across the cytoplasmic membrane, is removed, leaving the remaining protein anchored to the cell envelope. However, the proproteinase is not active until it is further processed by the maturation protein, PrtM. The latter presumably acts by inducing an autocatalytic cleavage event that results in hydrolysis of the pro region of the enzyme, leaving a mature PrtP with a molecular mass of 180–190 kD.

Although the proteinases among different strains of *Lc. lactis* are all genetically related and show only minor differences with respect to their amino acid sequence, the specific casein substrates and hydrolysis products of PrtP enzymes

from lactococci can vary considerably. For example, proteinases belong to group A (formerly P_{III}-type) hydrolyze α_{S1} -, β -, and K-caseins, whereas group E proteinases (formerly P_I-type) have a preference for β -casein and relatively little activity for α_{S1} - and K-caseins. Still, the functional organization of the PrtP and PrtM system varies little among lactococci. Both are required for rapid growth in milk, and genes for both (*prtP* and *prtM*, respectively) are induced when cells are grown in low-peptide media (e.g., milk) and repressed in peptide-rich media.

Over 100 caseinolytic products result from action of PrtP on β -casein (Juillard et al., 1995). Most are large oligopeptides (4–30 amino acid residues) with a major fraction between 4 and 10 residues. Free amino acids, dipeptides, and tripeptides are not formed. The first and most abundant oligopeptides formed by PrtP are generated from the C-terminal end of β -casein (Kunji et al., 1998), and it now appears that initial hydrolysis events cause casein to unfold so that other cleavage sites are exposed.

B. Amino Acid and Peptide Transport Systems

Although it was once believed that extracellular peptidases must be present to degrade further these peptides before transport, it is now well established that extracellular hydrolysis of peptides formed by PrtP does not occur, at least not by peptidases. Instead, lactococci and other lactic acid bacteria possess an array of amino acid and peptide transport systems able to transport substrates of varying size, polarity, and structure. Some of these are highly specific, whereas others have rather broad substrate specificity. They also vary as to energy sources used to fuel active transport.

As described earlier, the concentration of free amino acids in milk is too low to support growth of lactic acid bacteria. Still, lactococci possess at least 10 amino acid transporters, most of which are specific for structurally similar substrates. If the medium contains an adequate concentration of free amino acids, these transport systems can deliver enough amino acids to the cytoplasm to support growth. However, it has been suggested that the primary function of these transporters may be simply to excrete or efflux excess amino acids from the cytoplasm to maintain appropriate intracellular pool ratios (Kunji et al., 1996). That is, if peptides are indeed the primary source of amino acids, then some amino acids, generated from intracellular peptidases (see later), may accumulate faster than they can be assimilated. These free amino acids could then diffuse out of cells down their concentration gradient via the amino acid transporter operating in the reverse or efflux direction. If efflux of an amino acid is accompanied by a coupling ion (e.g., proton extrusion), then a net increase in the PMF is obtained. It may even be possible for amino acid efflux to provide enough energy to drive uptake of peptides (Kunji et al., 1996).

In contrast to the amino acid transporters, peptide transport is clearly necessary for lactic acid bacteria to grow in milk. Three groups of peptide transport systems have been identified. Two of these, DtpT and DtpP, transport dipeptides and tripeptides. DtpT is a large (463 amino acid residues) monomeric, PMF-dependent transporter that has affinity for hydrophilic peptides. Mutants with a deletion in the *dtpT* gene have been obtained and are unable to express DtpT and transport some peptides. In a defined medium, *dtpT* mutants grew poorly; however, growth of these mutants in milk was unaffected, indicating that DtpT is not essential in milk. DtpP, the other transport system in lactic acid bacteria that transports dipeptides and tripeptides, is an ATP-dependent transporter that has high affinity for hydrophobic peptides (Foucaud et al., 1995). It also appears to be unnecessary for growth of lactococci in milk.

The third and most important peptide transport system in lactic acid bacteria is the oligopeptide transport system (Opp). Since dipeptides and tripeptides are not released from casein, neither DtpT nor DtpP is required for growth in milk; lactococci instead rely on oligopeptides and Opp to satisfy all amino acid requirements. Indeed, mutants unable to express genes coding for the Opp system are unable to transport oligopeptides and are unable to grow in milk (Kunji et al., 1995; Tynkkynen et al., 1993). Although it was initially not known which oligopeptides were actually transported by Opp, many of the structural and genetic features of the Opp system in *Lc. lactis* are now well defined (Detmers et al., 1998). The Opp complex belongs to the ABC (ATP binding cassette) family of transporters and consists of five subunits: two transmembrane proteins (OppB and OppC), two ATP binding proteins (OppD and OppF), and a membrane-linked substrate-binding protein (OppA). The five genes coding for Opp are organized as an operon in the order *oppDFBCA*. A gene coding for an oligopeptidase (*pepO*) is also located immediately downstream of *oppA* and is cotranscribed with the *opp* operon.

The Opp system transports a diverse population of oligopeptides. Although PrtP releases over 100 peptides from β -casein, only 10–14 peptides apparently serve as substrates for Opp. All of these oligopeptides contain more than 4 and fewer than 11 amino acid residues (Kunji et al., 1998). Detailed analysis revealed that they contain proportionally higher levels of valine, proline, and glutamate and moderate levels of alanine, leucine, isoleucine, lysine, and serine. Importantly, these oligopeptides provide all essential amino acids, with the exception of histidine, needed by lactococci for growth in milk.

C. Peptidases

The third and final step of protein catabolism involves peptidolytic cleavage of Opp accumulated peptides. Over 20 different peptidases have been identified and

characterized, either biochemically and/or genetically, in lactococci and lactobacilli (Table 2). Both endopeptidases (those that cleave internal peptide bonds) and exopeptidases (those that cleave at terminal peptide bonds) are widely distributed. Of the latter, only aminopeptidases have been reported; carboxypeptidases apparently are not produced. In general, concerted efforts of endopeptidases, aminopeptidases, dipeptidases, and tripeptidases are required fully to utilize peptides accumulated by the Opp system. Although there was once considerable

Table 2 Peptidases from Lactic Acid Bacteria

Peptidase	Abbreviation	Substrate or specificity ^a
Aminopeptidase A	PepA	Glu/Asp \downarrow (X)n
Aminopeptidase C	PepC	X \downarrow (X)n
Aminopeptidase L	PepL	Leu \downarrow X Leu \downarrow X—X
Aminopeptidase N	PepN	X \downarrow (X)n
Aminopeptidase P	PepP	X \downarrow Pro—(X)n
Aminopeptidase X	PepX	X—Pro \downarrow (X)n
Pyrrolidone carboxyl peptidase	Pcp	Glu \downarrow (X)n
Dipeptidase V	PepV	X \downarrow X
Dipeptidase D	PepD	X \downarrow X
Tripeptidase T	PepT	X \downarrow X—X
Proiminopeptidase	PepI	Pro \downarrow X—(X)n
Prolidase	PepQ	X \downarrow Pro
Prolinase	PepR	Pro \downarrow X
Endopeptidase F	PepF	(X)n—X—X \downarrow X—(X)n
Endopeptidase O	PepO	(X)n—X \downarrow X—(X)n
Endopeptidase E	PepE	(X)n—X \downarrow X—(X)n
Endopeptidase G	PepG	(X)n—X \downarrow X—(X)n

^aThe positions of the hydrolyzed peptide bonds are shown by arrows.

debate on the location of these peptidases, it is now well accepted, based on genetic as well as physical evidence (e.g., lack of signal peptides and anchor sequences, cell fractionation, and immunogold labeling experiments), that they are intracellular enzymes. Substrate size and specificity and other properties of peptidases from lactic acid bacteria have been of considerable interest, not only because of their physiological importance but also because of the significant role peptidases play in cheese manufacture and ripening.

1. Endopeptidases

Several endopeptidases have been described, including PepF and PepO in *Lc. lactis* (Monnet et al., 1994) and PepE, PepG, and PepO in *Lb. helveticus* (Christensen et al., 1999). Most of these endopeptidases are metalloenzymes that contain sequences typical of zinc-binding domains and hydrolyze oligopeptides of varying lengths as substrates. It is interesting to note that some endopeptidases (e.g., PepF) have pH optima in an alkaline range (7.5–9.0) and that peptidase activity at pH levels typical of ripened cheese (e.g., < pH 6) are very low. Thus, the contribution of some of these enzymes either to cell physiology or to cheese ripening may be minor. In addition, growth of endopeptidase mutants in milk is not affected (Mierau et al., 1993; Monnet et al., 1994).

2. Dipeptidases and Tripeptidases

Dipeptides and tripeptides that accumulate from the medium or that are formed from intracellular peptidolytic cleavage of oligopeptides are subsequently hydrolyzed by dipeptidases and tripeptidases. Several of these have been purified and genes have been cloned (see Table 2) (Christensen et al., 1999). Although these enzymes vary with respect to their biochemical and physical properties, it appears, based on their substrate specificities, that some dipeptidases and tripeptidases serve important functions. Several dipeptidases are also prolinases or prolidases and hydrolyze peptides having N- or C-terminal proline residues. For example, PepQ from *Lc. lactis* and PepR from *Lb. helveticus* hydrolyze the dipeptides X-Pro and Pro-X, respectively (Boothe et al., 1990; Varmanen et al., 1996). Another peptidase that hydrolyzes proline-containing dipeptides and tripeptides has also been described (Baankries and Exterkate, 1991). The PepT tripeptidase from lactobacilli has preference for hydrophobic tripeptides (Savijoki and Palva, 2000). The role of these peptidases in cheese ripening will be discussed later.

3. Aminopeptidases

Aminopeptidases, enzymes that hydrolyze N-terminal peptide bonds and release N-terminal amino acids, are the most widespread peptidases found in lactic acid bacteria. Mierau et al. (1997) classified aminopeptidases based on their specific-

ity. The “general” or broad-specificity aminopeptidases, PepN and PepC, hydrolyze peptides ranging in size from 2 to 12 amino acids, and, in general, have little activity on proline-containing dipeptides. They are well conserved among lactococci and lactobacilli.

Because β -casein is proline rich, many of the PrtP-generated oligopeptides contain proline. As noted above, proline-containing peptides are often poor substrates for general peptidases. “Specific-task” aminopeptidases (e.g., PepA, PepX, PepP, PepR, and PepI), in contrast, can hydrolyze these proline-containing peptides. Like other peptidases, these aminopeptidases vary as to substrate size and specificities. The substrates of PepP from *Lc. lactis*, for example, are oligopeptides containing from 4 to 10 amino acids and having the sequence X-Pro-Pro-(X)_n (Mars and Monnet, 1995). In contrast, PepX from *Lc. lactis* hydrolyzes similar oligopeptides but in addition can also act on tripeptides, as well as some non-proline-containing peptides (Mayo et al., 1991). Both the general and specific aminopeptidases are especially important during cheese manufacture, since many oligopeptides contribute to bitter-flavored cheese if not degraded. The implications of proline-containing and other bitter peptides in cheese and their effect on flavor is discussed later.

Although it appears that no single peptidase is essential for cell growth, inactivation of multiple peptidases clearly is detrimental to growth in milk. Apparently, absence of a particular peptidase that degrades a particular peptide is not a very serious problem, since alternative peptides and peptidases are readily available. However, if several peptidases are missing, the rate of peptide hydrolysis would be expected to decrease. Indeed, when cells containing multiple mutations in *pepO*, *pepN*, *pepC*, *pepT*, and *pepX* were grown in milk, growth rates were reduced more than 10-fold (Mierau et al., 1996). That mutants reached final cell densities comparable to that of parent strains suggests that enough essential amino acids are eventually released by other peptidases.

D. Role of Protein Metabolism in Cheese Manufacture and Cheese Ripening

Although the PrtP system and components of the peptide transport and hydrolysis steps are essential for starter culture growth and activity, they also have important implications during cheese manufacture. Recent identification and characterization of many of the genes involved in protein metabolism have made it possible to construct mutants defective in a single enzymatic or transport activity. Comparing such mutant strains with the isogenic parent has provided a clearer picture of the role of various proteinase components on cheese properties.

Several studies have established that cheese made with strains deficient in proteinase activity lack flavor, have poor texture, and otherwise age poorly (Law et al., 1993). Thus, products of starter culture proteinases, combined with prod-

ucts of residual coagulant and milk proteases, impart desirable cheese flavor, either directly or by serving as substrates for additional reactions (Fox and Law, 1991; Urbach, 1995). However, despite the necessary role of PrtP in developing desirable aged cheese flavor, casein hydrolysis by PrtP also releases several peptides which are bitter. In general, bitter peptides are hydrophobic and their hydrolysis requires specific peptidases. Starter culture strains that possess the appropriate peptidases necessary to degrade these peptides are often considered as being “nonbitter” strains, as opposed to “bitter” strains that lack those enzymes and produce bitter cheese. Several peptidases have been proposed to have debittering activity (Baankreis et al., 1995; Tan et al., 1993). Experiments using peptidase mutants have provided *in vivo* evidence for the debittering role of peptidases. Cheese made with PepN or PepX mutants was bitter and had lower organoleptic quality (Mierau et al., 1997).

Although it is clear that bitterness, or lack of bitterness, is an important determinant of cheese flavor and quality, other aspects of protein metabolism undoubtedly influence the properties of aged cheese. Free amino acids and small peptides are thought to contribute to “nutty” and “sweet” flavor notes typical of Swiss, Parmesan, and other cheeses, whereas products of amino acid catabolism are primarily responsible for Cheddar cheese flavor (Fox and Wallace, 1997). Among degradation products formed from amino acids, methanethiol and other sulfur-containing compounds are considered to be essential in many cheese varieties, especially those that are surface ripened (Urbach, 1995; Weimer et al., 1999). Most of these sulfur compounds evolve from methionine and, for Cheddar, are produced by starter as well as nonstarter bacteria. Catabolism of aromatic and other amino acids by lactic acid bacteria certainly results in a large number of volatile compounds, some of which may be desirable, but others may be considered as flavor defects. However, the specific means by which metabolism of amino acids occurs and how products of nitrogen metabolism contribute to cheese flavor and quality await further study.

E. Lactic Acid Bacteria as Flavor Adjuncts

Once it was realized that peptidases from lactic acid bacteria could reduce bitterness and improve cheese flavor, several investigators began to identify suitable strains and to use them as culture adjuncts in cheese making. Species used as adjuncts include starter culture strains of *Lc. lactis* as well as nonstarter strains of *Lb. casei*, *Lb. helveticus*, and *Lb. delbrueckii* subsp. *bulgaricus*. In general, these strains have high peptidase activity. Since addition of such strains to cheese could also increase acid production, adjunct cultures are often prepared or used so that actual growth is minimized or prevented, while retaining their enzymatic activities. For example, using lactose-nonfermenting variants ensures that adjunct cells will not produce significant acid. Another way to deliver culture adjuncts

is to heat- or freeze-shock the cells, treatments that cause cells to lose acid-forming ability, before addition to milk or curd or to lyse early in the ripening process. Cell extracts can also be added directly, and commercial products containing peptidase-rich extracts have been developed and are used for accelerated cheese-ripening programs.

IV. CITRATE METABOLISM

Although rapid fermentation of lactose and production of lactic acid is a primary requirement for dairy lactic acid bacteria, the ability of selected strains to ferment citrate and form diacetyl is also an important property in many dairy products. Diacetyl contributes buttery aroma and flavor attributes in cultured butter, buttermilk, sour cream, and Gouda and Edam cheeses. Citrate fermentation also results in formation of CO₂, which is responsible for eye development in Dutch-style cheeses. Despite the practical importance of this fermentation, however, only recently have the key biochemical and metabolic events been defined.

A. Diacetyl Synthesis

Under ordinary conditions, citrate fermentation and diacetyl formation occur only in those strains of lactic acid bacteria that contain genes coding for transport and metabolism of citrate. Among the dairy lactic acid bacteria, citrate utilization is most often associated with *Leuconostoc* spp. and selected strains of *Lactococcus* sp. Accordingly, plasmids containing genes coding for citrate transport have been found in those strains that ferment citrate (López et al., 1998). In *Lc. lactis* subsp. *lactis* biovar *diacetylactis*, citrate fermentation is linked with an 8-kb plasmid, whereas in *Leuconostoc*, citrate genes are associated with plasmids as large as 22 kb. These plasmids contain a cluster of genes that encode citrate permease (CitP) in *Lc. lactis* subsp. *lactis* biovar *diacetylactis* and CitP and citrate lyase in *Leuc. paramesenteroides* (Martin et al., 1999).

How citrate-fermenting lactic acid bacteria actually form diacetyl has been the subject of considerable debate. Two pathways have been proposed. In both pathways, citrate is transported by the pH-dependent CitP that has optimum activity between pH 5 and 6. Transport is mediated by a PMF; however, as described below, the net bioenergetic effect of citrate metabolism may actually be an increase in the PMF. Intracellular citrate is then cleaved by citrate lyase to form acetate and oxaloacetate (Fig. 10). Although acetate is ordinarily released into the medium, oxaloacetate is decarboxylated to pyruvate by oxaloacetate decarboxylase. Importantly, the evolved CO₂ can cause eye formation in some cheeses. Although lactic acid bacteria could conceivably reduce all excess pyruvate to

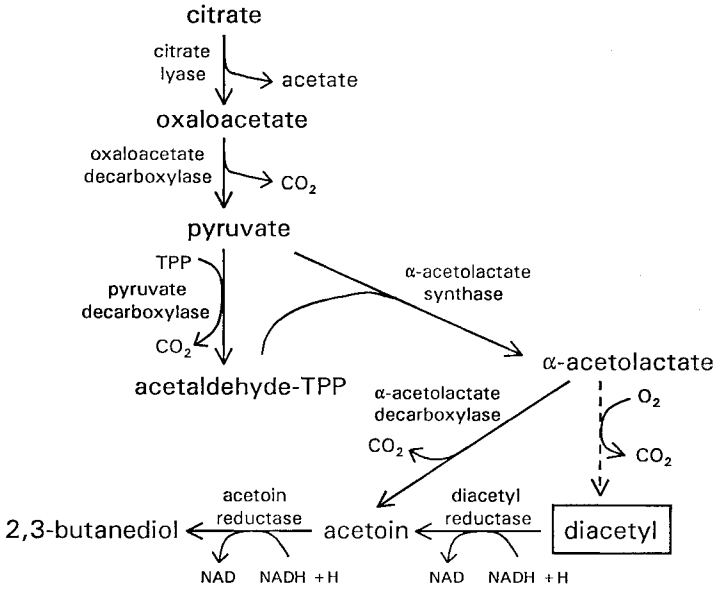

Figure 10 Citrate fermentation pathway in lactic acid bacteria. The dashed line indicates the nonenzymatic, oxidative decarboxylation reaction.

lactate via lactate dehydrogenase, this does not normally occur. This is because pyruvate reduction requires NADH, which is made during glycolysis, but which is not formed in the citrate fermentation pathway. Using NADH to reduce citrate-generated pyruvate would quickly deprive cells of the NADH pool necessary to reduce pyruvate produced during glycolysis. Instead, excess pyruvate is decarboxylated by pyruvate decarboxylase in a thiamine pyrophosphate (TPP)–dependent reaction, and acetaldehyde-TPP is formed. Some researchers have proposed that an enzyme (diacetyl synthase) is responsible for converting acetaldehyde-TPP (in the presence of acetyl-CoA) directly to diacetyl. However, no evidence for the presence of diacetyl synthase currently exists. Instead, the accepted alternative pathway for diacetyl synthesis involves first a condensation reaction of acetaldehyde-TPP and pyruvate catalyzed by α -acetolactate synthase. This enzyme apparently has a low affinity for pyruvate in *Lc. lactis* subsp. *lactis* biovar *diacetylactis* ($K_m = 50$ mM); thus high concentrations of pyruvate are necessary to drive this reaction (Snoep et al., 1992). The product, α -acetolactate, is unstable in the presence of oxygen and is next nonenzymatically decarboxylated to form diacetyl. This oxidative decarboxylation pathway is now supported by substantial biochemical, genetic, and nuclear magnetic resource evidence.

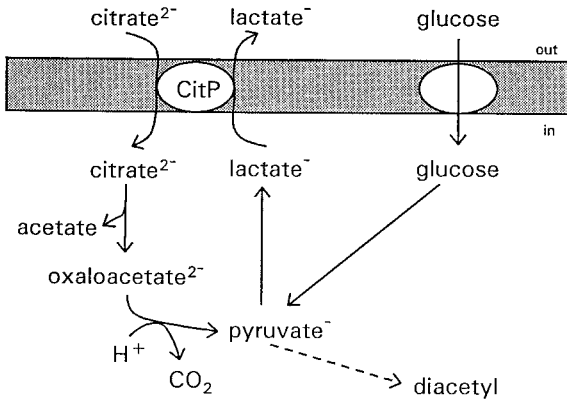

Figure 11 Citrate transport in lactic acid bacteria. Citrate is transported via CitP and lysed to form oxaloacetate. Decarboxylation of the latter consumes a proton and forms pyruvate, which can be converted to diacetyl (dashed line). Lactate formed via sugar metabolism (or from citrate) is effluxed in exchange for citrate.

Although utilization of citrate by lactic acid bacteria requires several enzymatic steps, it appears that citrate fermentation provides cells with no obvious benefits, as ATP-generating reactions are absent in this pathway and citrate consumption results only in excretion of organic endproducts and CO₂. Why then do cells ferment citrate? As noted earlier, the driving force for transport of citrate is the PMF, with divalent citrate transported in symport with a single proton (Fig. 11). However, during the oxaloacetate decarboxylation reaction, a cytoplasmic proton is consumed, resulting in an increase in the cytoplasmic pH and an increase in the ΔpH component of the PMF. In addition, when citrate-utilizing bacteria are grown in the presence of a fermentable sugar and lactate is produced, efflux of monovalent (anionic) lactate can drive uptake of divalent (anionic) citrate. Thus, CitP acts as a electrogenic precursor-product exchanger, with a net increase in the $\Delta\psi$ or electrical component of the PMF. Both of these mechanisms (electrogenic exchange and decarboxylation), therefore, result in an increase in the metabolic energy available to the cell (Bandell et al., 1998).

B. Enhancing Diacetyl Formation in Dairy Products

Even among citrate-fermenting lactic acid bacteria, the amount of diacetyl formed in dairy products is relatively low (<2 mg/L), and there is much interest in manipulating growth conditions and cultures in an effort to enhance diacetyl production in cheese and cultured milk products. Because citrate transport via CitP re-

quires low pH (see above), citrate-fermenting strains are usually combined with acid-producing strains during manufacture of cultured dairy products. Oxygen can also stimulate diacetyl formation by as much as 30-fold (Boumerdassi et al., 1996). Presumably, high atmospheric oxygen can reduce activity of lactate dehydrogenase and accelerate the oxidative decarboxylation reaction responsible for diacetyl synthesis. In addition, oxygen can oxidize NADH, thereby slowing the rate at which diacetyl is reduced to acetoin or 2,3-butanediol (see Fig. 10). Another strategy considered for enhancing diacetyl formation involves genetic modification of the cultures. Several metabolic steps have been identified at which mutations or blocks will lead to increased production of diacetyl. Inactivation of lactate dehydrogenase, for example, results in excess pyruvate, and such cells could theoretically produce more diacetyl than wild-type cells (even non-citrate-fermenting lactococci have been genetically manipulated to produce diacetyl). Enhanced expression of plasmid-borne copies of genes coding for α -acetolactate synthase or NADH oxidase in *Lc. lactis* also enhances diacetyl formation by increasing the concentration of α -acetolactate available for oxidative decarboxylation (Benson et al. 1996; de Felipe et al., 1998). Similarly, inactivation of the gene coding for α -acetolactate decarboxylase, the enzyme that forms acetoin directly from α -acetolactate, also results in an increase in diacetyl production (Monnet et al., 1997; Swindell et al., 1996).

V. METABOLISM OF PROPIONIBACTERIA

Although not a lactic acid bacterium, *Propionibacterium freudenreichii* subsp. *shermanii* is an important part of the thermophilic starter culture used to manufacture Swiss-type cheeses. This organism is not only responsible for producing CO₂ that leads to eye or hole formation, but it also produces other compounds, including amino acids and their degradation products, that contribute to the characteristic flavor of these cheeses (Gagnaire et al., 1999).

During Swiss cheese manufacture, growth of *Pro. freudenreichii* subsp. *shermanii* does not occur until the primary lactic fermentation is completed and cheese is moved into a “warm room” held at 20–25°C. Although propionibacteria can ferment lactose, essentially none is available at this time and instead lactate is the primary energy source for their growth in cheese. Fermentation of lactate yields propionate, acetate, and CO₂, with a theoretical molar ratio as:



In cheese, the actual amount of CO₂ may vary either as a result of condensation reactions, cometabolism with amino acids, or strain variation. The propionate pathway consists of many reactions, and it requires several metal-containing en-

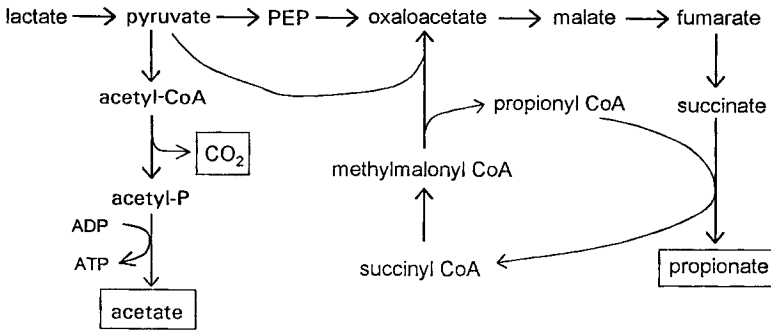

Figure 12 The propionate pathway of propionibacteria. Only the key intermediate compounds are shown. A more complete description of the enzymes and cofactors is given by Piveteau, 1999.

zymes and vitamin cofactors (Fig. 12). Enzymes of the citric acid cycle are also required. One mole of ATP is generated per mole of lactate consumed.

Although proteolysis of casein by *Pro. shermanii* is limited because of low proteinase activity, it does produce several peptidases (Gagnaire et al., 1999; Langsrud et al., 1995). These peptidases are located intracellularly, and their substrates are the peptides released by starter culture proteinases and residual milk and coagulant proteinases. Although no information on peptide transport systems in propionibacteria is currently available, there is evidence that some peptidases could be released via autolysis (Østlie et al., 1995). Several peptidases have activity on proline-containing peptides, accounting for high levels of proline that accumulate in Swiss-type cheeses. In addition, metabolism of the amino acids alanine and aspartate may contribute to CO₂ production (Langsrud et al., 1995).

VI. METABOLISM OF MOLDS AND OTHER FLAVOR-CONTRIBUTING MICROORGANISMS

Despite their importance in several cheese types, much less is known about the metabolism of *Penicilium* spp. and brevibacteria used to make mold-ripened and surface-ripened cheeses. These organisms are not really starter cultures, since they do not contribute to acid development, but they are just as integral to the cheese making process as are the lactic starter cultures. Accordingly, their main role in cheese manufacture is to produce flavors and cause desirable changes in texture and appearance of the finished cheese (also see Chaps. 6 and 11).

A. *Penicillium roqueforti*

The mold responsible for the well-known blue-veined appearance of Roquefort, Gorgonzola, and other blue cheese types is *P. roqueforti*. Although spores of *P. roqueforti* are added to milk or curds before the lactic fermentation, mold growth does not occur until after the lactic culture has fermented all or most of the available lactose to lactic acid. Lactic acid serves as an energy source for the mold. Importantly, consumption of lactic acid causes the pH to rise from about 4.6 to as high as 6.2 (Marth and Yousef, 1991). As *P. roqueforti* grows in cheese, substantial proteolysis occurs through elaboration of several extracellular proteinases, endopeptidases, and exopeptidases. Amino acids can be subsequently metabolized releasing amines, ammonia, and other possible flavor compounds (that also may raise the pH). However, the most characteristic blue cheese flavors are generated from lipid metabolism (Gripon, 1987). As much as 20% of triglycerides in milk are hydrolyzed by lipases produced by *P. roqueforti*. Although free volatile fatty acids may themselves contribute to cheese flavor, their metabolism, via β -oxidation pathways, results in formation of a variety of methylketones. It is this class of compounds that is responsible for the flavor of blue cheese.

B. *P. camemberti*

Just as in blue-veined cheeses, growth of *P. camemberti* in the manufacture of Camembert and Brie cheeses occurs as a secondary fermentation, and again, lactic acid is used as an energy source. The subsequent rise in pH (from 4.6 to as high as pH 7.0 at the surface) because of lactate consumption and ammonia production provides opportunities for other organisms to grow, and the surface microflora of Camembert cheese can be quite diverse. The proteinases and peptidases produced by *P. camemberti* are similar to those produced by *P. roqueforti* (Gripon, 1987). Although *P. roqueforti* grows throughout the cheese mass (because of deliberate aeration during cheese making), growth of *P. camemberti* is confined to the surface; therefore, protein breakdown in the interior of cheese is dependent on diffusion of excreted enzymes. Production of ammonia, methanethiol, and other sulfur compounds, presumably derived from amino acids, are also characteristic of Camembert cheese. Lipolysis of triglycerides and fatty acid metabolism by *P. camemberti* are just as important in surface-ripened cheese as in blue-veined cheese, and methylketones are abundant (Gripon, 1987).

C. *Brevibacterium linens*

Although *B. linens* is primarily used in the manufacture of Muenster, brick, and other surface-ripened cheeses, its potential use as a flavor adjunct has led to re-

newed interest in the metabolism of this organism (Rattray and Fox, 1999). Most attention has focused on proteinases and peptidases produced by *B. linens* and subsequent formation of volatile flavor compounds from amino acid metabolism. Unlike lactic acid bacteria that produce a single proteinase (PrtP), *B. linens* produces several extracellular and intracellular proteinases and peptidases. Metabolism of released amino acids results in formation of many sulfur-containing compounds, including hydrogen sulfide, methanethiol, and other volatile flavors that are characteristic not only of surface-ripened cheese but which are also important in Cheddar cheese. The ability of *B. linens* to produce these flavor compounds, along with a high level of proteolytic activity, have led to the use of this organism as a flavor adjunct in Cheddar-type cheeses (Weimer et al., 1999).

VII. METABOLIC ENGINEERING

Considerable information currently exists on many of the important genes and metabolic pathways that influence how lactic acid bacteria grow in yogurt, cheese, and other dairy products. Recently, the genome sequence of *Lc. lactis* was reported (Bolotin et al., 1999), and the genome sequence of *Lb. acidophilus* is expected to be completed soon. Efforts to use this information to improve or modify properties of lactic acid bacteria have already begun and are certain to be accelerated (Hugenholtz and Kleerebezem, 1999). As described earlier in this chapter, metabolic engineering could be used in several ways to improve dairy fermentations. Diverting pyruvate from lactate to the flavor compound diacetyl can be accomplished by genetically disrupting genes coding for lactate dehydrogenase or α -acetolactate decarboxylase. Similarly, cheese ripening can be accelerated by either increasing expression of genes involved in proteolysis or by induced expression of genes coding for lytic enzymes (de Ruyter et al., 1998; McGarry et al., 1994). Increased synthesis of an exopolysaccharide by *Lc. lactis* subsp. *cremoris* was achieved by overexpressing the gene coding for fructose-bisphosphatase, an enzyme that makes more precursors available for polysaccharide synthesis (Looijesteijn et al., 1999). Finally, efforts are underway in several laboratories to engineer *S. thermophilus* so that galactose is fermented rather than released back into the curd or cheese.

REFERENCES

- Baankries R, Exterkate FA. Characterisation of a peptidase from *Lactococcus lactis* subsp. *cremoris* HP that hydrolyzes di- and tripeptides containing proline or hydrophobic residues as the aminoterminal amino acid. *System Appl Microbiol* 14:317, 1991.
- Baankreis R, van Schalkwijk S, Altling AC, Exterkate FA. The occurrence of two intracel-

- lular oligoendopeptidases in *Lactococcus lactis* and their significance for peptide conversion in cheese. *Appl Microbiol Biotechnol* 44:386, 1995.
- Bandell M, Lhotte ME, Marty-Teyssset C, Veyrat A, Prévost H, Dartois V, Diviès C, Konings WN, Lolkema JS. Mechanisms of the citrate transporters in carbohydrate and citrate cometabolism in *Lactococcus* and *Leuconostoc* species. *Appl Environ Microbiol* 64:1594, 1998.
- Benateya A, Bracquart P, Linden G. Galactose-fermenting mutants of *Streptococcus thermophilus*. *Can J Microbiol* 37:136, 1991.
- Benson KH, Godon, J-J, Renault P, Griffin HG, Gasson MJ. Effect of *invBN*-encoded α -acetolactate synthase expression on diacetyl production in *Lactococcus lactis*. *Appl Microbiol Biotechnol* 45:107, 1996.
- Bolotin A, Mauger S, Malarme K, Ehrlich SD, Sorokin A. Low-redundancy sequencing of the entire *Lactococcus lactis* IL 1403 genome. *Antonie van Leeuwenhoek* 76:27, 1999.
- Boothe M, Jennings PV, Fhaolain IN, O'Quinn G. Prolidase activity of *Lactococcus lactis* subsp. *cremoris* AM2: partial purification and characterization. *J Dairy Sci* 57:245, 1990.
- Boumerdassi H, Desmazeaud M, Monnet C, Boquien CY, Corrieu G. Improvement of diacetyl production by *Lactococcus lactis* subsp. *lactis* CNRZ 483 through oxygen control. *J Dairy Sci* 79:775, 1996.
- Christensen JE, Dudley EG, Pederson JA, Steele JL. Peptidases and amino acid catabolism in lactic acid bacteria. *Antonie van Leeuwenhoek* 76:217, 1999.
- Cocaign-Bousquet M, Garrigues C, Loubiere P, Lindley NC. Physiology of pyruvate metabolism in *Lactococcus lactis*. *Antonie van Leeuwenhoek* 70:253, 1996.
- Detmers FJM, Kunji ERS, Lanfermeijer FC, Poolman B, Konings WN. Kinetics and specificity of peptide uptake by the oligopeptide transport system of *Lactococcus lactis*. *Biochemistry* 37:16671, 1998.
- de Felipe FL, Kleerebezem M, de Vos WM, Hugenholtz J. Cofactor engineering: a novel approach to metabolic engineering in *Lactococcus lactis* by controlled expression of NADH oxidase. *J Bacteriol* 180:3804, 1998.
- de Ruyter PGG, Kuipers OP, Meijer WC, de Vos VM. Food-grade controlled lysis of *Lactococcus lactis* for accelerated cheese ripening. *Nat Biotechnol* 15:976, 1998.
- de Vos, WM. Metabolic engineering of sugar catabolism in lactic acid bacteria. *Antonie van Leeuwenhoek* 70:223, 1996.
- de Vos WM, Boerrigter IJ, van Rooyen RJ, Reiche B, Hengstenberg W. Characterization of the lactose-specific enzymes of the phosphotransferase system in *Lactococcus lactis*. *J Biol Chem* 265:22554, 1990.
- Foucaud C, Kunji ERS, Hagting A, Richard J, Konings WN, Desmazeaud M, Poolman B. Specificity of peptide transport systems in *Lactococcus lactis*: evidence for a third system which transports hydrophobic di- and tripeptides. *J Bacteriol* 177:4652, 1995.
- Fox PF, Law J. Enzymology of cheese ripening. *Food Biotechnol* 5:239, 1991.
- Fox PF, Wallace JM. Formation of flavor compounds in cheese. *Adv Appl Microbiol* 45:17, 1997.
- Gagnaire V, Mollé D, Sørhaug T, Léonil J. Peptidases of dairy propionic acid bacteria. *Lait* 79:43, 1999.

- Garrigues C, Loubiere P, Lindley NC, Cocaign-Bousquet M. Control of shift from homo-lactic acid to mixed-acid fermentation in *Lactococcus lactis*: predominant role of the NADH/NAD⁺ ratio. *J Bacteriol* 179:5282, 1997.
- Gosalbes MJ, Monedero V, Alpert C.-A., Pérez-Martínez G. Establishing a model to study the regulation of the lactose operon in *Lactobacillus casei*. *FEMS Microbiol Lett* 148:83, 1997.
- Gosalbes MJ, Monedero V, Pérez-Martínez G. Elements involved in catabolite repression and substrate induction of the lactose operon in *Lactobacillus casei*. *J Bacteriol* 181:3928, 1999.
- Gripou JC. Mould-ripened cheeses. In: Fox PF, ed. *Cheese: Chemistry, Physics and Microbiology*. Vol 2. Major Cheese Varieties. London: Elsevier, 1987, p 121.
- Grossiord B, Vaughan EE, Luesink E, de Vos WM. Genetics of galactose utilisation via the Leloir pathway in lactic acid bacteria. *Lait* 78:77, 1998.
- Hugenholz J, Kleerebezem M. Metabolic engineering of lactic acid bacteria: overview of the approaches and results of pathway rerouting involved in food fermentations. *Curr Opin Biotechnol* 10:492, 1999.
- Hutkins RW, Ponne C. Lactose uptake driven by galactose efflux in *Streptococcus thermophilus*: evidence for a galactose-lactose antiporter. *Appl Environ Microbiol* 57: 941, 1991.
- Juillard V, Laan H, Kunji ERS, Jeronimus-Stratingh CM, Bruins AP, Konings WN. The extracellular P-type proteinase of *Lactococcus lactis* hydrolyzes β -casein into more than one hundred different oligopeptides. *J Bacteriol* 177:3472, 1995.
- Kunji ERS, Hagting A, de Vried CJ, Juillard V, Haandrikman AJ, Poolman B, Konings WN. Transport of β -casein-derived peptides by the oligopeptide transport system is a crucial step in the proteolytic pathway of *Lactococcus lactis*. *J Biol Chem* 270: 1569, 1995.
- Kunji ERS, Mierau I, Hagting A, Poolman B, Konings WN. The proteolytic systems of lactic acid bacteria. *Antonie van Leeuwenhoek* 70:187, 1996.
- Kunji ERS, Fang G, Jeronimus-Stratingh CM, Bruins AP, Poolman B, Konings WN. Reconstruction of the proteolytic pathway for use of β -casein by *Lactococcus lactis*. *Mol Microbiol* 27:1107, 1998.
- Langsrud T, Sørhaug T, Vegarud GE. Protein degradation and amino acid metabolism by propionibacteria. *Lait* 75:325, 1995.
- Law J, Fitzgerald GF, Uniacke-Lowe T, Daly C, Fox PF. The contribution of lactococcal starter proteinases to proteolysis in Cheddar cheese. *J Dairy Sci* 76:2455, 1993.
- Looijesteijn PJ, Boels IC, Kleerebezem M, Hugenholz J. Regulation of exopolysaccharide production by *Lactococcus lactis* subsp. *cremoris* by the sugar source. *Appl Environ Microbiol* 65:5003, 1999.
- López P, Drider D, García-Quintans N, Corrales MA, Magni C, Martín M, de Mendoza D. Regulation of expression of the *Lactococcus lactis* subsp. *lactis* biovar *diacetylactis* citrate transport system. *Lait* 78:11, 1998.
- Luesink EJ, Kuipers OP, de Vos WM. Regulation of the carbohydrate metabolism in *Lactococcus lactis* and other lactic acid bacteria. *Lait* 78:69, 1998a.
- Luesink EJ, van Herpen REMA, Grossiord BP, Kuipers OP, de Vos WM. Transcriptional activation of the glycolytic *las* operon and catabolite repression of the *gal* operon

- in *Lactococcus lactis* are mediated by the catabolite control protein CcpA. Mol Microbiol 30:789, 1998b.
- Luesink EJ, Beumer CM, Kuipers OP, de Vos WM. Molecular characterization of the *Lactococcus lactis ptsHI* operon and analysis of the regulatory role of HPr. J Bacteriol 181:764, 1999.
- Mars I, Monnett V. An aminopeptidase P from *Lactococcus lactis* with original specificity. Biochim Biophys Acta 1243:209, 1995.
- Marth EH, Yousef AE. Fungi and dairy products. In: Arora DK, Mukerji KG, Marth EH, eds. Handbook of Applied Mycology. Vol 3. Foods and Feeds. New York: Marcel Dekker, 1991, p 375.
- Martin M, Corrales MA, de Mendoza D, López P, Magni C. Cloning and molecular characterization of the citrate utilization *citMCDEFGRP* cluster of *Leuconostoc paramesenteroides*. FEMS Microbiol Lett 174:231, 1999.
- Mayo B, Kok J, Venema K, Bockelman W, Teuber M, Reinke H, Venema G. Molecular cloning and sequence analysis of the X-propyl dipeptidyl aminopeptidase gene from *Lactococcus lactis* susp. *cremoris*. Appl Environ Microbiol 57:38, 1991.
- McGarry A, Law J, Coffey A, Daly C, Fox PF, Fitzgerald GF. Effect of genetically modifying the lactococcal proteolytic system on ripening and flavor development in Cheddar cheese. Appl Environ Microbiol 60:4226, 1994.
- McKay LL, Baldwin KA. Simultaneous loss of proteinase- and lactose-utilizing enzyme activities in *Streptococcus lactis* and reversal by transduction. Appl Microbiol 28:342, 1974.
- McKay LL, Walter RA, Sandine WE, Elliker PR. Involvement of phosphoenolpyruvate in lactose utilization by group N streptococci. J Bacteriol 99:603, 1969.
- Mierau I, Tan PST, Haandrikman AJ, Kok J, Leenhouts KJ, Konings WN, Venema G. Cloning and sequencing of the gene for a lactococcal endopeptidase, an enzyme with sequence similarity to mammalian enkephalinase. J Bacteriol 175:2087, 1993.
- Mierau I, Kunji ERS, Leenhouts KJ, Hellendoorn MA, Haandrikman AJ, Poolman B, Konings WN, Venema G, Kok J. Multiple peptidase mutants of *Lactococcus lactis* are severely impaired in their ability to grow in milk. J Bacteriol 178:2794, 1996.
- Mierau I, Kunji ERS, Venema G, Kok J. Casein and peptide degradation in lactic acid bacteria. Biotechnol Genet Eng Rev 14:279, 1997.
- Monnet C, Schmitt P, Diviès C. Development and use of a screening procedure for production of α -acetolactate by *Lactococcus lactis* subsp. *lactis* biovar *diacetylactis* strains. Appl Environ Microbiol 63:793, 1997.
- Monnet V, Nardi M, Chopin A, Chopin M.-C., Gripon J.-C. Biochemical and genetic characterization of PepF, an oligopeptidase from *Lactococcus lactis*. J Biol Chem 269:32070, 1994.
- Mustapha A, Hutkins RW, Zirnstein GW. Cloning and characterization of the galactokinase gene from *Streptococcus thermophilus*. J Dairy Sci 78:989, 1995.
- Østlie H, Floberhagen V, Reinbold G, Hammond EG, Vegarud G, Langsrud T. Autolysis of dairy propionibacteria: growth studies, peptidase activities, and proline production. J Dairy Sci 78:1224, 1995.
- Piveteau P. Metabolism of lactate and sugars by dairy propionibacteria: a review. Lait 79:23, 1999.

- Poolman B, Royer TJ, Mainzer SE, Schmidt BF. Lactose transport system of *Streptococcus thermophilus*: a hybrid protein with homology to the melibiose carrier and enzyme III of phosphoenolpyruvate-dependent phosphotransferase systems. *J Bacteriol* 171: 244, 1989.
- Poolman B, Royer TJ, Mainzer SE, Schmidt BF. Carbohydrate utilization in *Streptococcus thermophilus*: characterization of the genes for aldose 1-epimerase (mutarotase) and UDPglucose 4-epimerase. *J Bacteriol* 172:4037, 1990.
- Rattray FP, Fox PF. Aspects of enzymology and biochemical properties of *Brevibacterium linens* relevant to cheese ripening: a review. *J Dairy Sci* 82:891, 1999.
- Saier MH Jr, Chauvaux S, Deutscher J, Reizer J, Ye J-J. Protein phosphorylation and regulation of carbon metabolism in gram-negative versus gram-positive bacteria. *Trends Biochem Sci* 20:267, 1995.
- Savijoki K, Palva A. Purification and molecular characterization of a tripeptidase (PepT) from *Lactobacillus helveticus*. *Appl Environ Microbiol* 66:794, 2000.
- Snoep JL, Teixeira de Mattos TMJ, Starrenburg MJC, Hugenholtz J. Isolation, characterization, and physiological role of pyruvate dehydrogenase complex and α -acetolactate synthase of *Lactococcus lactis* subsp. *lactis* bv. *diacetylactis*. *J Bacteriol* 174: 4838, 1992.
- Steele JL. Genetics and metabolism of starter cultures. In: Marth EH, Steele JL, eds. *Applied Dairy Microbiology*. New York: Marcel Dekker, 1998, p 173.
- Swindell SR, Benson KH, Griffin HG, Renault P, Ehrlich SD, Gasson MJ. Genetic manipulation of the pathway for diacetyl metabolism in *Lactococcus lactis*. *Appl Environ Microbiol* 62:2641, 1996.
- Tan PST, van Kessel TAJM, van de Veerdonk FLM, Zuurendonk PF, Bruins AP, Konings WN. Degradation and debittering of a tryptic digest from β -casein by aminopeptidase N from *Lactococcus lactis* subsp. *cremoris* WG2. *Appl Environ Microbiol* 59: 1430, 1993.
- Thomas TD, Crow VL. Selection of galactose-fermenting *Streptococcus thermophilus* in lactose-limited chemostat cultures. *Appl Environ Microbiol* 48:186, 1994.
- Thompson J. Regulation of sugar transport and metabolism in lactic acid bacteria. *FEMS Microbiol Rev* 46:221, 1987.
- Thompson J, Chassy BM. Intracellular hexose-6-phosphohydrolase from *Streptococcus lactis*: purification, properties, and function. *J Bacteriol* 156:70, 1983.
- Tynkkynen S, Buist G, Kunji E, Kok J, Poolman B, Venema G, Haandrikman. Genetic and biochemical characterization of the oligopeptide transport system of *Lactococcus lactis*. *J Bacteriol* 175:7523, 1993.
- Urbach G. Contribution of lactic acid bacteria to flavour compound formation in dairy products. *Int Dairy J* 5:877, 1995.
- van Rooijen RJ, de Vos WM. Molecular cloning, transcriptional analysis, and nucleotide sequence of *lacR*, a gene encoding the repressor of the lactose phosphotransferase system of *Lactococcus lactis*. *J Biol Chem* 265:18499, 1990.
- Varmanen P, Steele JL, Palva A. Characterization of a prolinase gene and its product, and an adjacent ABC transporter gene from *Lactobacillus helveticus*. *Microbiology* 142:809, 1996.
- Weimer B, Seefeldt K, Dias B. Sulfur metabolism in bacteria associated with cheese. *Antonie van Leeuwenhoek* 76:247, 1999.

- Yan T-R, Azuma N, Kaminogawa S, and Yamauchi K. Purification and characterization of a novel metallopeptidase from *Streptococcus cremoris* H61. *Eur J Biochem* 163: 259, 1987.
- Ye JJ, Saier MH Jr. Purification and characterization of a small membrane-associated sugar-phosphate phosphatase that is allosterically activated by HPr(Ser(P)) of the phosphotransferase system in *Lactococcus lactis*. *J Biol Chem* 270:16740, 1995a.
- Ye JJ, Saier MH Jr. Cooperative binding of lactose and the phosphorylated phosphocarrier protein HPr(Ser-P) to the lactose/H⁺ symport permease of *Lactobacillus brevis*. *Proc Natl Acad Sci* 92:417, 1995b.
- Ye JJ, Reizer J, Cui X, Saier MH Jr. Inhibition of the phosphoenolpyruvate:lactose phosphotransferase system and activation of a cytoplasmic sugar-phosphate phosphatase in *Lactococcus lactis* by ATP-dependent metabolite-activated phosphorylation of serine 46 in the phosphocarrier protein HPr. *J Biol Chem* 269:11837, 1994.

8

Genetics of Lactic Acid Bacteria

Jeffery R. Broadbent

*Utah State University
Logan, Utah*

I. INTRODUCTION

Human civilizations throughout history have placed great practical and economic value on methodologies to improve keeping qualities of foods. One of the most ancient of these practices involves fermentation by lactic acid bacteria (LAB) that are indigenous to raw milk, meat, vegetables, and cereal grains. The LAB are a diverse group of gram-positive (gram⁺) cocci, coccobacilli, and bacilli whose defining characteristics are that they (1) have a low (<55 mol%) G + C content; (2) are acid tolerant; (3) are nonsporing; (4) are nutritionally fastidious; (5) are aerotolerant but not aerobic; (6) are unable to synthesize porphyrins; and (7) have a strictly fermentative metabolism with lactic acid as the major metabolic endproduct.

The taxonomy of LAB is an active area of research, and several additions and refinements have been made in recent years. Among them are annexation of several new genera that satisfy the phylogenetic and physiological definition of a lactic acid bacterium (e.g., *Aerococcus*, *Alloiococcus*, *Atopobium*, *Dolosigranulum*, *Eremococcus*, *Gemella*, *Globicatella*, *Lactosphaera*, *Melissococcus*, and *Vagococcus*) (Axelsson, 1998; Collins et al., 1999; Vandamme et al., 1996), but which do not hold any important food fermentation species. The LAB that do have a significant role in food fermentation include *Carnobacterium*, *Enterococcus* (*En.*), *Lactobacillus* (*Lb.*), *Lactococcus* (*Lc.*), *Leuconostoc* (*Leuc.*), *Oenococcus*, *Pediococcus*, *Streptococcus*, *Tetragenococcus*, and *Weissella*. Discussions in this chapter will primarily address genetics of *Lactobacillus*, *Lactococcus*, *Leuconostoc*, and *Streptococcus*, because these genera include starter (and non-

starter) bacteria that are most important to the dairy fermentation industry. However, species of *Carnobacterium*, *Enterococcus*, *Pediococcus*, and even *Aerococcus* have been isolated from adventitious populations of LAB in ripening cheese (Bhowmik and Marth, 1990; Morea et al., 1999), and genes from these and other LAB may be of interest to the dairy industry. As a result, knowledge gleaned from genetic studies of these and other nondairy LAB will be noted where it helps to provide clarity and depth to our view of genetics in dairy LAB. Because the scope of this chapter limits the degree to which individual topics can be addressed, readers seeking more detailed discussions of the genetics and microbiology of food-grade LAB are referred to the works of Gasson and De Vos (1994) and Salminen and von Wright (1998).

A. Why Study the Genetics of Dairy Lactic Acid Bacteria?

Because LAB are common constituents of the raw milk microbiota, it is likely that fermented milk foods have been part of the human diet since milk was first collected in containers. Over the centuries, these inadvertent fermentations were slowly shaped into the more than 1000 unique cheeses, yogurts, and fermented milks that are available today. Because these products evolved well before the emergence of microbiological science, their manufacturing processes all relied upon spontaneous acidification of milk (caused, of course, by endogenous LAB). It was not until discovery of the lactic acid fermentation by Pasteur in 1857, and development of pure LAB dairy starter cultures later that century, that the door to industrialized milk fermentations was opened. Since that time, the economic value of fermented milk foods, and especially cheese, has experienced dramatic and sustained growth. Cheese production in the United States alone, for example, has increased more than 200% in the last quarter century, and total worldwide production now equals approximately 13 million tons per year (IDF, 1994, 1999).

To sustain such a high level of productivity and diversity, the dairy industry has become a leader in starter microbiology and fermentation technology. Experience has proved that industrial production of uniform, high-quality fermented milk foods is facilitated by use of well-characterized starter bacteria. Thus, even though a number of traditional milk fermentations still rely on natural souring of raw milk, virtually all industrialized processes employ starter cultures. Because the economic vitality of this industry depends to a very large degree on starter cultures with known, predictable, and stable characteristics, great resources and efforts have been directed toward understanding the physiology and genetics of dairy LAB. The knowledge base that has been built from that work can and has been used genetically to effect precise refinements in metabolic attributes of dairy starter cultures. With literally hundreds of industrial and academic laboratories now devoting resources to LAB physiology and genetics research, it is clear that molecular-genetic strain improvement strategies will play an important role in

tomorrow's dairy industry. Research during the last quarter century focused primarily on cellular biochemistry and development of genetics tools, with limited application in key areas such as bacteriophage resistance. Work in the coming decades should see widespread application of this knowledge in ways that will improve product quality and consistency, promote consumer health and well-being, reduce manufacturing losses and safety concerns, and further expand the diversity of fermented dairy products in the market place.

II. GENETIC ELEMENTS

Because of its singular economic importance as the starter bacterium for industrial production of Cheddar and Gouda cheeses, and the relative ease by which it can be handled in the laboratory, much of our current understanding of genetics in dairy LAB has come from study of *Lc. lactis* subsp. *lactis* and *Lc. lactis* subsp. *cremoris* (henceforth jointly described as *Lc. lactis*). A third subspecies, *Lc. lactis* subsp. *hordniae*, is not used as a dairy starter and will not be considered further. In this section, we will examine four types of genetic elements that have been characterized at the nucleotide sequence level in *Lc. lactis* and, to a lesser extent, other dairy LAB. They include plasmid DNA, transposable elements, bacteriophages and, most impressively, the bacterial chromosome.

A. Plasmid DNA

Plasmids are extrachromosomal, autonomously replicating DNA molecules that exist independently of the bacterial chromosome. Molecular and genetic studies of bacterial plasmids have yielded extraordinary insight into cellular mechanisms for DNA replication, gene transfer, gene expression, and genetic recombination. Plasmids have also played an integral role in development and evolution of recombinant DNA technologies for many organisms, including dairy LAB.

Most plasmids are covalently closed circular molecules, but linear plasmids have been reported in several eubacteria including one species of LAB, *Lb. gasseri* (Davidson et al., 1996; Meinhardt et al., 1997). The number of copies at which a particular plasmid species exists within a bacterium (i.e., its copy number) varies widely and can range from as few as one or two to tens or even hundreds of molecules (Actis et al., 1999; Clewell, 1981). Under most conditions, plasmid-coded functions are not essential to host survival (exceptions involve properties such as antibiotic resistance that confer a selective advantage under specific environmental conditions), but they may allow the cell to compete better with other microorganisms that share their ecological niche. Therefore, if a daughter cell loses a particular plasmid species through plasmid replication or segregation errors, it will usually continue to grow and may even predominate

over its wild-type population. Loss of the plasmid will, however, result in permanent loss of any trait encoded by that plasmid.

The first reports of plasmid DNA in LAB were published in the early 1970s by researchers working with *En. faecalis* and *S. mutans* (Clewell, 1981). Among food-grade LAB, it was the long-standing observation that many *Lc. lactis* dairy starters permanently lost their acid- or flavor-producing phenotypes (and the fact that the frequency of these events was increased under plasmid curing conditions) that served to stimulate the first inquiries into the plasmid biology of these organisms (McKay, 1983). We now recognize that lactococci are an especially fertile source of plasmid DNA, and that genes for many of this bacterium's industrially important traits are encoded by plasmids. The latter discovery enlivened worldwide interest in LAB plasmid biology and genetics, and we now know that plasmid DNA is a frequent component of the genome in leuconostocs, oenococci, pediococci, and some lactobacilli. Plasmids have also been identified less frequently in other food-grade LAB, including *Carnobacterium*, *S. thermophilus*, *Tetragenococcus*, and *Weissella* (Benachour et al., 1997; Brito and Paveia, 1999; Davidson et al., 1996; Martin et al., 1999). The rich diversity of plasmid species in LAB is fortuitous, because it provides a ready source of extrachromosomal replicons to support development of gene-cloning vectors (De Vos and Simons, 1994; von Wright and Sibakov, 1998; Wang and Lee, 1997). In addition, although most of these plasmids are cryptic, several interesting and useful phenotypic properties have been linked to plasmid DNA in food-grade LAB (Table 1).

1. Plasmid Replication

The segregational and structural stability of extrachromosomal DNA can be influenced by the mode of plasmid replication (Biet et al., 1999; Gruss and Ehrlich, 1989; Kiewiet et al., 1993; Lee et al., 1998), and the industrial significance of plasmid DNA in LAB warrants attention to the molecular biology of plasmid replication and segregation in these bacteria. Characterization of the nucleotide sequence and genetic organization of plasmid replicons in eubacteria has identified five distinct systems for plasmid replication; circular plasmids may replicate via rolling-circle replication (RCR), theta replication, or strand displacement, whereas linear plasmids are thought to replicate through virus-like processes that involve formation of circular intermediates (hairpin plasmids) or protein priming (plasmids with 5'-linked proteins) (Actis et al., 1999; Del Solar et al., 1998; Meinhardt et al., 1997). The replication system(s) employed by linear plasmids of *Lb. gasseri* have yet to be characterized, but nucleotide sequence and structural analysis of replicons from several circular LAB plasmids has confirmed that these molecules replicate by RCR or theta mechanisms (De Vos and Simons, 1994; von Wright and Sibakov, 1998; Wang and Lee, 1997).

a. Rolling-Circle Replication The most common type of replication system in plasmids from LAB and other gram⁺ bacteria is RCR, a process that involves synthesis of single-stranded DNA (ssDNA) intermediates (Fig. 1). Because ssDNA is a reactive intermediate in all DNA recombination processes, RCR plasmids are particularly vulnerable to segregational and structural instability (Gruss and Ehrlich, 1989; Kiewiet et al., 1993). As might be expected, this attribute can be problematic to gene-cloning strategies with vectors constructed from RCR plasmid replicons (Biet et al., 1999; De Vos and Simons, 1994; Lee et al., 1998).

Plasmids that replicate by the RCR model have been identified in *Lc. lactis*, *O. oeni*, and in several species of lactobacilli, leuconostocs, and streptococci (including *S. thermophilus*) (Biet et al., 1999; Khan, 1997). These plasmids are relatively small (most are 1.3–10.0-kb pairs), broad host range molecules (many RCR plasmids from LAB can replicate in *Escherichia [Es.] coli*) that share several structural features (Khan, 1997). These include (1) a *rep* gene, encoding an origin-specific replication initiation protein (Rep) that has nicking and religating activities; (2) a double-strand (plus) origin, *ori*, where Rep nicks the leading strand of DNA to initiate replication and where, after each replicative cycle, Rep nicks a second time to release the leading strand; and (3) a single-strand (minus) origin, *ss*, where replication of the lagging strand is initiated (and whose recognition appears critical in determining plasmid host range and stability). In addition, RCR plasmids typically encode functions that regulate plasmid copy number. The three most common mechanisms involve the synthesis of a *rep* repressor protein or production of antisense RNAs that either attenuate *rep* transcription or inhibit Rep mRNA translation (Khan, 1997).

Amino acid and nucleotide sequence alignments of Rep proteins and their double-strand origins, respectively, have shown that RCR plasmids can be subdivided into at least five families represented by plasmids pT181, pE194, pC194, pSN2, and pIJ101 (Khan, 1997). Thus far, most RCR plasmids that have been characterized in LAB fall within the pE194 and pC194 families, but a few members of the pT181 family have also been identified (Alegre et al., 1999; Biet et al., 1999; Khan, 1997). In addition, several RCR plasmids from LAB and other gram⁺ bacteria do not belong to any of the five existing families, which suggests that the number of RCR plasmid families will expand as more replicons are characterized (Khan, 1997; Wang and Lee, 1997).

Further research to classify RCR plasmids from LAB will serve to clarify the basic understanding of RCR replicons in general, and it will also benefit applied dairy science because this property can influence plasmid incompatibility (and thus the segregational stability of extrachromosomal gene cloning vectors in LAB hosts with native plasmid DNA). *Incompatibility* is a term that refers to the inability of independent replicons to coexist stably within the same host cell in the absence of any selective pressure. Plasmids that possess identical replication

Table 1 Plasmid-Encoded Properties in Food-Grade Lactic Acid Bacteria

Trait	Species (reference)
Bacteriocin production/immunity	
Class I: lantibiotics	<i>Lb. sake</i> , <i>Lc. lactis</i> (Dodd and Gasson, 1994 ^a)
Class II: small heat-stable proteins	<i>C. piscicola</i> , <i>Lb. acidophilus</i> , <i>Lb. brevis</i> , <i>Lb. curvatus</i> , <i>Lb. johnsonii</i> , <i>Lb. plantarum</i> , <i>Lb. sake</i> , <i>Lc. lactis</i> , <i>Ln. carnosum</i> , <i>Ln. gelidum</i> , <i>Ln. mesenteroides</i> , <i>P. acidilactici</i> (Dodd and Gasson, 1994 ^a ; Herbin et al., 1997; Kanatani et al., 1995; Tichaczek et al., 1993; Van Reenen et al., 1998; Wang and Lee, 1997 ^a)
Class IV: complex bacteriocins	<i>P. acidilactici</i> (Schved et al., 1993)
Bacteriophage defense	
Abortive infection	<i>Lc. lactis</i> (Hill, 1993 ^a)
Phage adsorption	<i>Lc. lactis</i> (Hill, 1993 ^a)
Restriction/modification	<i>Lb. helveticus</i> , <i>Lc. lactis</i> (Hill, 1993 ^a)
Carbohydrate transport/hydrolysis	
Galactose phosphotransferase (PTS)	<i>Lb. acidophilus</i> , <i>Lc. lactis</i> (Arihara and Luchansky, 1995 ^a ; McKay, 1983 ^a ; De Vos and Vaughan, 1994 ^a)
Lactose PTS	<i>Lb. acidophilus</i> , <i>Lb. casei</i> , <i>Lc. lactis</i> (McKay, 1983 ^a ; De Vos and Vaughan, 1994 ^a ; Wang and Lee, 1997 ^a)
Lactose (non-PTS)	<i>Lb. plantarum</i> , <i>Ln. lactis</i> (De Vos and Vaughan, 1994 ^a ; Mayo et al., 1994)
Maltose PTS	<i>Lactobacillus</i> sp. (Chou, 1992)
Melibiose	<i>P. pentosaceus</i> (Ray, 1995 ^a)
N-acetyl-D-glucosamine	<i>Lb. helveticus</i> (Arihara and Luchansky, 1995 ^a)
Raffinose	<i>P. pentosaceus</i> (Ray, 1995 ^a)
Sorbitol	<i>Lactobacillus</i> sp. (Wang and Lee, 1997 ^a)
Sucrose	<i>P. acidilactici</i> , <i>P. pentosaceus</i> (Ray, 1995 ^a)

Citrate transport/hydrolysis	<i>Lb. plantarum</i> , <i>Lc. lactis</i> , <i>Ln. lactis</i> , <i>Ln. mesenteroides</i> subsp. <i>mesenteroides</i> , <i>W. paramesenteroides</i> (Martin et al., 1999; McKay, 1983 ^a , Vaughan et al., 1994; Wang and Lee, 1997 ^a)
Exopolysaccharide biosynthesis	<i>Lb. casei</i> , <i>Lc. lactis</i> (Arihara and Luchansky, 1995 ^a ; Van Kranenburg et al., 1997)
Proteolysis	
ATP-dependent proteinase	<i>Lc. lactis</i> (Huang et al., 1993)
Endopeptidase	<i>Lc. lactis</i> (Nardi et al., 1997)
Extracellular proteinase	<i>Lb. helveticus</i> , <i>Lc. lactis</i> (McKay, 1983 ^a ; Wang and Lee, 1997 ^a)
Oligopeptide uptake	<i>Lc. lactis</i> (Yu et al., 1996)
Resistance plasmids	
Clinical antibiotics	
Chloramphenicol	<i>Lb. acidophilus</i> , <i>Lb. plantarum</i> , <i>Lb. reuteri</i> , <i>Lc. lactis</i> (Teuber et al., 1999 ^a ; Wang and Lee, 1997 ^a)
Erythromycin	<i>Lb. fermentum</i> , <i>Lb. reuteri</i> (Teuber et al., 1999 ^a)
Kanamycin	<i>Lactobacillus</i> sp. (Wang and Lee, 1997 ^a)
Streptomycin	<i>Lactobacillus</i> sp., <i>Lc. lactis</i> (Teuber et al., 1999 ^a ; Wang and Lee, 1997 ^a)
Tetracycline	<i>Lb. fermentum</i> , <i>Lc. lactis</i> (Teuber et al., 1999 ^a ; Wang and Lee, 1997 ^a)
Inorganic ions	
Arsenate	<i>Lb. helveticus</i> , <i>Lc. lactis</i> (McKay, 1983 ^a ; Wang and Lee, 1997 ^a)
Chromate	<i>Lc. lactis</i> (McKay, 1983 ^a)
Cadmium	<i>Lc. lactis</i> (Liu et al., 1996)
Copper	<i>Lc. lactis</i> (Khunajakr et al., 1999)
Nisin resistance	<i>Lc. lactis</i> (Froseth et al., 1988)
Ultraviolet light	<i>Lc. lactis</i> (Chopin et al., 1986)
Small heat-shock protein	<i>S. thermophilus</i> (Somkuti et al., 1998)

^a Review paper.

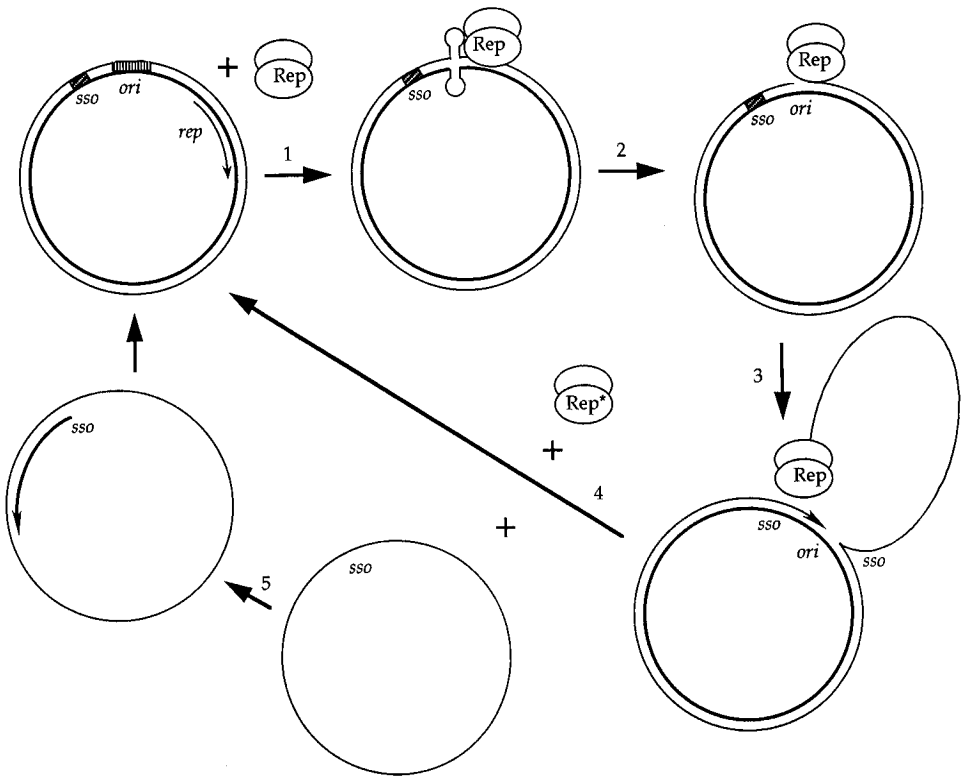

Figure 1 Circular plasmid replication by the rolling-circle model (RCR). The light and heavy lines in each part of the plasmid diagram represent the leading and lagging strand of DNA, respectively. Key events include (1) binding of the replication initiator protein *Rep* (whose active form may be mono-, di-, or multimeric) to the double-strand origin (*ori*) produces a structural change in the DNA at *ori* (e.g., cruciform DNA in pT181); (2) *Rep* then nicks the leading strand at a specific site within *ori*, and an initiation complex is formed between *Rep* and host replication factors such as DNA polymerase III, DNA helicase, and single-stranded-DNA binding protein; (3) DNA replication from the *Rep*-dependent nick site proceeds with leading strand displacement until *ori* is regenerated; (4) *Rep*, which is believed to remain in close proximity to the replication fork, terminates replication via sequential nicking-closing reactions at *ori*. This releases a circular leading strand of DNA and an inactivated *Rep* protein (*Rep**) and produces a regenerated double-strand plasmid; (5) Lagging-strand replication is then initiated at the single-stranded origin (*sso*) exclusively by host-encoded proteins that may include RNA polymerase and the DNA polymerases I and III. Other host factors such as DNA ligase and DNA gyrase, are also likely involved in plasmid RCR. (Adapted from Khan, 1997.)

control mechanisms are incompatible, because the control systems cannot distinguish between each molecule, and so replication of either plasmid becomes random (Snyder and Champness, 1997). Incompatibility between RCR plasmids from the same family has been noted, and this phenomenon was attributed to cross recognition between each molecule's Rep proteins and *ori* sequences (Grohmann et al., 1998). Plasmid incompatibility between gene-cloning vectors and native plasmids may also contribute to low transformation efficiencies in LAB (Luchansky et al., 1988; Posno et al., 1991; Van der Lelie et al., 1988).

b. Theta Replication In contrast to RCR, theta-type plasmid replication does not involve formation of large regions of ssDNA, and so theta plasmids are far less vulnerable to DNA rearrangements. The practical significance of this attribute is highlighted most effectively by studies on *Bacillus subtilis* that showed cloning vectors derived from theta replicons can stably accommodate very large (>300-kb) or multimeric DNA inserts (Itaya and Tanaka, 1997; Lee et al., 1998). Improved stability of large-insert DNA in vectors derived from theta replicons has also been demonstrated in *Lc. lactis* (Kiewiet et al., 1993).

Replication of theta plasmids involves strand separation at one or more specific loci, synthesis of an RNA primer, and then progressive uni- or bidirectional DNA replication with simultaneous synthesis of leading and lagging strands. Theta-type replicons are very common in gram-negative (gram⁻) bacteria but, as noted above, they appear to occur less frequently than RCR plasmids in LAB and other gram⁺ bacteria. Nonetheless, theta replicons have been identified on small, intermediate-sized, and large plasmids from *Lb. helveticus*, *Lb. sake*, *Lc. lactis*, *P. pentosaceus*, *T. halophilus*, and from several enterococci and pathogenic streptococci (Benachour et al., 1997; Bruand et al., 1993; Kantor et al., 1997; Kearney et al., 2000).

Differences in genetic structure and the requirement for host encoded DNA polymerase I during replication can be used to separate eubacterial theta replicons into six distinct classes, designated A–F (Bruand et al., 1993; Del Solar et al., 1998; Meijer et al., 1995; Tanaka and Ogura, 1998). Class A replicons encode a replication initiation protein, Rep, and have an origin of replication, *oriA*, composed of an AT-rich region and a series of short, directly repeated sequences called iterons (which also play an important role in regulation of plasmid copy number). These plasmids do not require host DNA polymerase I for replication. Class B, C, E, and F replicons are distinguished by the absence of a typical *oriA* sequence, the presence of a plasmid-coded Rep protein (class C and F replicons), and a requirement for DNA polymerase I (classes B and C). Class D replicons encode Rep and have an *oriA*-like sequence, but it is not required for replication. They are also similar in structure and in their requirement for DNA polymerase I to class C replicons, but the replicative regions of class D and C plasmids lack any significant DNA sequence homology (Bruand et al., 1993). Like RCR

plasmids, theta-type replicons may also encode a *rep* repressor protein or anti-sense RNAs that serve to regulate plasmid copy number (Actis et al., 1999).

Many theta plasmids that have been identified in LAB appear to possess a class A replicon, and most of these have been isolated from *Lc. lactis* (Kearney et al., 2000). However, class D replicons have been found in enterococci and pathogenic streptococci, and it now looks as though several LAB species may possess class F theta replicons (Kearney et al., 2000). As with basic studies of RCR replicons, research into theta plasmid replication in LAB will continue to provide new insight into basic mechanisms for plasmid replication, copy control, and segregation in gram⁺ bacteria (Bruand et al., 1993; Gravesen et al., 1997; Kearney et al., 2000). Because these factors are directly related to plasmid incompatibility (Actis et al., 1999), studies in this area will also facilitate strain improvement efforts that involve introduction of extrachromosomal vectors into LAB hosts that contain native plasmids. On this note, it is important to point out that although many *Lc. lactis* class A theta replicons share regions of high sequence homology, these plasmids are often compatible with one another (Gravesen et al., 1995). Nonetheless, incompatibility groups and determinants have been identified for some theta plasmids in LAB (Gravesen et al., 1997; Seegers et al., 1994), and additional research is needed to define plasmid incompatibility groups within and among (for broad host range plasmids) different species of LAB.

B. Transposable Elements

Transposable elements are discrete sequences that have the ability to move from one site to another in DNA. Three types of mobile genetic elements have been found in LAB: insertion sequences (IS), transposons, and introns. By virtue of their mobility, these elements promote genetic rearrangements that can affect the organization, expression, and regulation of existing genes. In addition to insertional inactivation of target or adjacent genes, transpositional elements can also induce expression of flanking genes. The latter activity is thought to result from creation of new promoters that comprise an out-directed -35 promoter consensus sequence that is present in terminal inverted repeats of some elements, and an appropriately spaced -10 hexamer in DNA that flanks the insertion site (Mahillon and Chandler, 1998).

Transposons and IS elements also promote more extensive forms of intragenomic rearrangements such as cointegrations, inversions, and deletions. Comparative genomic analysis of *Lc. lactis*, for example, has revealed that an inversion encompassing approximately half of the chromosome in strain ML3 is the result of homologous recombination between two copies of IS905 (Daveran-Mingot et al., 1998). Insertion sequence-mediated plasmid cointegration is also well documented in this species (Anderson and McKay, 1984; Polzin and Shimizu-Kadota, 1987; Romero and Klaenhammer, 1990).

Finally, transposable elements can contribute to genetic variation in bacteria by facilitating horizontal gene transfer between different strains, species, and genera (Arber, 2000; Brisson et al., 1988). Among the LAB, transposons play an important role in dissemination of virulence factors among pathogenic enterococci and streptococci (Horaud et al., 1996; McAshen et al., 1999; Teuber et al., 1999), and recent evidence suggests IS elements were involved in horizontal transfer of genes for exopolysaccharide production between *Lc. lactis* and *S. thermophilus* (Bourgoin et al., 1996 and 1999). From a more practical perspective, transposable elements can be useful tools for molecular analysis of LAB genetics, physiology, and metabolism, and for development of integrative gene cloning vectors (Dinsmore et al., 1993; Israelsen et al., 1995; Le Bourgeois et al., 1992b; Maguin et al., 1996; Polzin and McKay, 1992; Ravn et al., 2000; Walker and Klaenhammer, 1994).

1. Insertion Sequences

The IS described in LAB range in size from approximately 0.8 to 1.5 kb, with 16–40 bp inverted repeats on left and right ends (Table 2). Like other prokaryotic IS, they are compact elements that only encode transposase and *cis*-acting sequences required for transposition, and their location is almost always flanked by short, direct repeats (3–8 bp) that reveal the target sequence used for insertion into new sites (Mahillon and Chandler, 1998). Mechanisms involved in IS transposition are both varied and complex, and they are quite beyond the scope of this chapter. Readers interested in this topic are referred to the reviews of Haren et al. (1999) and Mizuuchi (1992).

Discovery of the first IS element in LAB arose from a series of elegant experiments to ascertain the cause of abnormal fermentations during production of a fermented skim milk beverage (Shimizu-Kadota and Sakurai, 1982; Shimizu-Kadota et al., 1983, 1985). Those studies showed that abnormal fermentations at several factories were caused by the same virulent bacteriophage, designated ϕ FSV, which was serologically, morphologically, and biochemically identical to a temperate phage (ϕ FSW) harbored by the starter bacterium, *Lb. casei* S-1 (Shimizu-Kadota and Sakurai, 1982; Shimizu-Kadota et al., 1983). Structural analysis of the ϕ FSV and ϕ FSW genomes revealed ϕ FSV contained 1.3 kb of additional DNA, and nucleotide sequence analysis revealed this region contained an IS, designated *ISL1*. Southern hybridization showed *ISL1* was present on the *Lb. casei* S-1 chromosome, which led to the conclusion that ϕ FSV arose from ϕ FSW by *ISL1* transposition from the chromosome to a region of the prophage that controlled lysogeny (Shimizu-Kadota et al., 1985). With this knowledge, the Yakult company was able to isolate a prophage-cured derivative of *Lb. casei* S-1 and eliminate further emergence of ϕ FSV in their factories (Shimizu-Kadota and Sakurai, 1982).

Table 2 Insertion Sequences in Dairy Lactic Acid Bacteria

Original host and element name ^a	Size (bp)	Inverted repeat (bp) ^b	IS Family ^c	Copies per genome	Host range (references) ^d
<i>Lactobacillus</i>					
ISL1	1256	40	IS3	1–3	<i>Lb. casei</i> subsp. <i>casei</i> , <i>Lb. zaeae</i> (Shimizu-Kadota et al., 1985, 1988) ^e
ISL2	858	16	IS5	4–21	<i>Lb. helveticus</i> (Zwahlen and Mollet, 1994) ^f
ISL3	1494	38	ISL3	1–9	<i>Lb. delbrueckii</i> subsp. <i>bulgaricus</i> (Germond et al., 1995) ^g
ISLh1	962	35	IS982	ND ^h	<i>Lb. helveticus</i> (Pridmore et al., 1994)
IS125	1024	24	IS30	ND ^h	<i>Lb. plantarum</i> (Ehrmann et al., 2000)
IS1163	1180	39	IS3	2	<i>Lb. sake</i> (Skaugen and Nes, 1994)
IS1201	1387	24	IS256	3–16	<i>Lb. helveticus</i> (Tailliez et al., 1994)
IS1223	1492	25	IS3	ND ^h	<i>Lb. johnsonii</i> (Walker and Klaenhammer, 1994)
<i>Lactococcus lactis</i>					
ISS1	808	18	IS6	1–20	<i>En. faecium</i> , <i>En. hirae</i> , <i>Lb. plantarum</i> , <i>Lc. lactis</i> , <i>Ln. mesenteroides</i> subsp. <i>dextranicum</i> , <i>S. thermophilus</i> (Bourgoin et al., 1996; Ehrmann et al., 2000; Polzin and Shimizu-Kadota, 1987; Polzin et al., 1993; Ward et al., 1996) ⁱ
IS214	809	23	IS6	3 ^j	<i>En. faecium</i> , <i>Lc. lactis</i> (Teuber et al., 1999)
IS215 (IS1077)	1448	14	IS3	1–7 ^k	<i>Lc. lactis</i> (Bolotin et al., 1999; Teuber et al., 1999)
IS904	1241	39	IS3	5–9	<i>Lc. lactis</i> (Dodd et al., 1990)
IS905	1313	28	IS256	≥ 16	<i>Lc. lactis</i> , <i>S. thermophilus</i> (Dodd et al., 1994; Guédon et al., 1995)
IS981	1222	40	IS3	4–26	<i>Lc. lactis</i> , <i>S. thermophilus</i> (Polzin and McKay, 1991; Guédon et al., 1995)

IS982	1003	18	IS982	1–20	<i>Lc. lactis</i> (Yu et al., 1995)
IS983	1067	25	IS30	15 ^k	<i>Lc. lactis</i> (Bolotin et al., 1999; A. Sorokin, personal communication)
<i>Leuconostoc</i>					
IS1070	1027	28	IS30	≥ 15	<i>Ln. lactis</i> (Vaughan and De Vos, 1995)
IS1165	1553	39	ISL3	4–13	<i>Ln. mesenteroides</i> subsp. <i>cremoris</i> (Johansen and Kibenich, 1992) ^l
<i>Streptococcus thermophilus</i>					
IS1193	1411	24	ISL3	ND ^h	<i>S. thermophilus</i> (Schmitt et al., 1998)
IS1194	1200	16	IS4	1	<i>S. thermophilus</i> , <i>Lc. lactis</i> (Bourgoin et al., 1998) ^m

^a Bacterium from which the element was originally isolated.

^b Length in base pairs of the terminal repeat sequences.

^c Classification scheme based on the major features of prokaryotic IS families. See Mahillon and Chandler (1998) for details.

^d As established from the nucleotide sequence of the IS or one of its isoforms.

^e DNA-DNA hybridizations indicated that this element was not present in 8 other *Lactobacillus* sp. or 12 species from 8 other genera.

^f DNA-DNA hybridizations indicated this element was not present in *Lb. acidophilus*, *Lb. delbrueckii*, or *S. thermophilus*.

^g DNA-DNA hybridizations indicated this element was not present in *Lb. acidophilus*, *Lb. casei*, *Lc. lactis*, or *S. thermophilus*.

^h Not determined.

ⁱ ISSI elements have been divided into three subgroups (α , β , and γ) based on nucleotide sequence homology (Bourgoin et al., 1996). Southern hybridizations detected homologous sequences in *Lb. casei*, *Lb. plantarum*, *En. faecalis* and *P. acidilactici* but not in *Lb. acidophilus*, *Lb. gasseri*, or *Ln. paramesenteroides* (Polzin et al., 1993). DNA-DNA hybridizations detected homologous sequences in *Lb. casei* and *Lb. plantarum* (Huang et al., 1992).

^j Information on copy number is limited to the *Lc. lactis* multidrug resistance plasmid pK214.

^k As determined from the nucleotide sequence of the *Lc. lactis* multidrug resistance plasmid pK214 or of the *Lc. lactis* IL1403 genome.

^l Homologous sequences were detected by DNA-DNA hybridization in *Lb. casei*, *Lb. helveticus*, *Ln. lactis*, *O. oeni*, and *Pediococcus* sp. but not in *Lc. lactis*.

^m DNA-DNA hybridization detected homologous sequences in *Lc. lactis* but not *Lb. delbrueckii*.

Several other IS elements have since been identified in many dairy LAB, including other species of *Lactobacillus*, *Lc. lactis*, *S. thermophilus*, and leuconostocs (see Table 2). Nucleotide sequence analysis and DNA-DNA hybridizations have established that several of these elements are present in multiple copies throughout the LAB genome (plasmids and chromosome), and that related sequences are present in most (and probably all) industrially important LAB. Existence of iso-IS elements (e.g., *ISS1*) in many different LAB species, and proximity of these elements to plasmid-borne genes encoding important milk fermentation properties (e.g., lactose and citrate utilization, proteinase production, and phage resistance) suggests that IS were probably important in the evolutionary adaptation of LAB to a milk environment (Bourgoin et al., 1999; Davidson et al., 1996; Magni et al., 1996).

2. Transposons

Two types of transposons can be distinguished in dairy LAB: composite transposons and conjugative transposons. Composite transposons typically consist of a nonmobile central region that is flanked on each side by complete IS elements that provide the transposition factors. Given the frequency at which some IS occur in the chromosome and plasmid DNAs of *Lc. lactis* and other dairy LAB (see Table 2), elements that satisfy the structural definition of a composite transposon may be quite common in genomes of these bacteria. A few putative elements have been identified in *Lc. lactis* and *S. thermophilus*, but conclusive proof for intracellular transposition by any naturally occurring composite transposon in food-grade LAB is still lacking (Bourgoin et al., 1999; Duan et al., 1996; Huang et al., 1993; Romero and Klaenhammer, 1991; Teuber et al., 1999). Nonetheless, transposition of an artificial composite transposon that was assembled with *IS946* elements has been demonstrated in *Lc. lactis* (Romero and Klaenhammer, 1991), and functional mobility for some native elements is evidenced by the fact that they contain IS elements (and intervening DNA regions) that have clearly been acquired through horizontal gene transfer (Bourgoin et al., 1999; Teuber et al., 1999). Readers should also recognize that several functionally active composite transposons have been identified in enterococci and streptococci, where these elements contribute to the problematic spread of antibiotic resistance genes (Horaud et al., 1996; Teuber et al., 1999; Woodford 1998).

a. Conjugative Transposons With a size range of 18–70 kb, the conjugative transposons of gram⁺ bacteria are generally larger and more complex mobile elements than composite transposons. Conjugative transposons were originally discovered in the late 1970s in pathogenic LAB, and current models for their transposition are derived largely from studies of the enterococcal transposon *Tn916* and other *Tn916*-like elements (Salyers and Shoemaker, 1997). Members

of the Tn916 family of transposons have a very broad host range that extends to more than 50 species in 24 bacterial genera (Jaworski and Clewell, 1995).

Like IS and composite transposons, conjugative transposons are able to excise from and insert into chromosomal or plasmid DNA, but some aspects of their transposition are more akin to plasmids and temperate bacteriophages than to other transposable elements. Excision of a conjugative transposon, for example, is followed by its conversion into a plasmid-like covalently closed circular DNA molecule (which is, however, incapable of autonomous replication) that can be transferred by conjugation in single-stranded form into another (recipient) cell. Moreover, mechanisms for integration and excision of the circular DNA intermediate are phage-like in that they require a transposon-encoded integrase, and excision is stimulated by the transposon's *xis* gene product (Salyers et al., 1995).

As was hinted above, several conjugative transposons have been identified in enterococcal and streptococcal clinical isolates, and these elements are now recognized for their integral role in dissemination of antibiotic resistance genes to many species of bacteria (Teuber et al., 1999). In contrast, the only conjugative transposons to be conclusively identified thus far in food-grade LAB are the very large (approximately 70 kb) and genetically related nisin-sucrose transposons of *Lc. lactis*. These elements do not appear to encode antibiotic resistance genes and seem to be far less promiscuous than their enterococcal and streptococcal counterparts. Evidence for the latter assertion comes from the observation that although intraspecific conjugation of these transposons has been demonstrated by several groups, genetic proof for intergeneric transfer has only been documented once (Broadbent and Kondo, 1991; Broadbent et al., 1995).

Interest in lactococcal nisin-sucrose transposons stems from the finding that they encode genes for nisin biosynthesis and immunity. Nisin is a broad-spectrum lantibiotic that is widely used as a preservative to combat gram⁺ spoilage and pathogenic bacteria in food (Horn et al., 1991). Structural characterization of several nisin-sucrose transposons has revealed that conjugative elements can be separated into two classes, designated I and II, whose structures are represented by Tn5276- and Tn5278-like transposons, respectively (Rauch et al., 1994). A third group of nisin-sucrose "transposons," class III elements, appear to be derived from class II transposons, but the former elements cannot be transferred by conjugation and probably lack transpositional mobility.

As shown in Fig. 2, group I nisin-sucrose transposons have an IS904 element near their left junction, just upstream of genes for biosynthesis of nisin A (one of two natural nisin variants). Another IS, IS981, lies downstream of the nisin gene cluster and adjacent to genes for sucrose metabolism via a sucrose-specific phosphoenolpyruvate-dependent phosphotransferase system. Like Tn916, genes involved in Tn5276 excision and integration are located near the

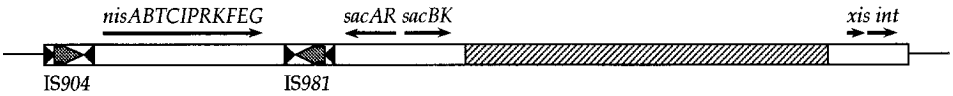

Figure 2 Genetic organization of the lactococcal group I nisin-sucrose transposon Tn5276. The transcriptional orientation of genes for nisin biosynthesis (*nisA-G*), sucrose utilization (*sac*), excision (*xis*), and integration (*int*) are illustrated by black arrows above the element, and orientations of putative transposase genes in IS904 and IS981 are indicated by the thick gray arrows. The hatched area represents the region of the transposon for which DNA sequence information has not yet been reported. Map is not to scale.

right end of the transposon (De Vos et al., 1995). Much of the region between *xis* and *sacBK* (see Fig. 2) has not been described, but phenotypic characterization of transconjugants suggests it may include genes for conjugative self-transfer, resistance to certain bacteriophages, and synthesis of N⁵-(carboxyethyl)ornithine (Gonzales and Kunka, 1985; Thompson et al., 1991). The structure of group II nisin-sucrose transposons has not been as extensively characterized, but they are known to lack the left-end copy of IS904 and to encode genes for biosynthesis of nisin Z instead of nisin A (Rauch et al., 1994).

Very recently, Burrus and coworkers (2000) described an element in *S. thermophilus* that appears to represent a new species of conjugative transposon in LAB. This element, termed ICESt1, is 35.5 kb in length and encodes, near its right terminus, genes whose products show extensive homology to proteins involved in conjugation, excision, and integration of other conjugative transposons, including Tn916 and Tn5276. Although conjugal transfer of ICESt1 has not yet been confirmed, strong evidence for *in vivo* and *int*-dependent excision of the element into a circular intermediate form has been presented. Interestingly, ICESt1 also contains a truncated copy of the lactococcal element IS981, which suggests that conjugal transposition of ICESt1 (or a larger transposon from which it was derived) may have facilitated horizontal gene transfer between *Lc. lactis* and *S. thermophilus* (Burrus et al., 2000).

3. Group I and Group II Introns

Group I and group II introns are ribozymes that catalyze a self-splicing reaction from mRNA species that contain the intron, and many of these sequences also function as mobile genetic elements. The most common type of transposition event noted for group I and group II introns is termed "homing," wherein the intron will insert itself into an allele that lacks the cognate element. However, group II (and perhaps group I) introns can also effect transposition to other locations in the genome (Lambowitz and Belfort, 1993). Although they were once thought to be confined exclusively to eukaryotic cells, introns are now known to

occur in a wide range of prokaryotes (Belfort et al., 1995). Self-splicing representatives of both groups have now been identified in LAB, where their discovery and characterization have shed new light on intron evolution and biology (Foley et al., 2000; Mikkonen and Alatossava, 1995; Mills et al., 1996).

a. Group I Introns In addition to self-splicing activity, many group I introns encode a site-specific endonuclease that confers homing mobility on the intron. The mechanism for homing in group I introns is reasonably well understood, and is thought to occur through a recombination repair process that resembles gene conversion. Homing is initiated by the endonuclease, which creates a double-strand break at a specific target in the intron-free allele, then cleaved DNA strands of the recipient are partially degraded by exonucleases. The gap created in recipient DNA is filled in using the donor strand as the template, which results in coconversion of any exon sequences that were lost to nucleolytic degradation. It is important to note that mobile, endonuclease-encoding group I introns appear to be confined to multicopy genomes such as mitochondria, chloroplasts, and bacteriophages, and this observation has led to suggestions that inefficient double-strand break repair may limit viability in hosts with a single-copy genome (Lambowitz and Belfort, 1993). Given this background, it is not unexpected to learn that all mobile group I introns identified to date in LAB reside in bacteriophage genomes (Foley et al., 2000; Mikkonen and Alatossava, 1995; Van Sinderen et al., 1996).

The first group I intron identified in a LAB was located in a gene encoding the large terminase subunit of the *Lb. delbrueckii* subsp. *lactis* virulent bacteriophage LL-H (Mikkonen and Alatossava, 1995). The LL-H intron is 837 bp in length and encodes a 168-amino acid (aa) protein that has good homology to intron-encoded DNA endonucleases found in *B. subtilis* phages. Although the extreme 3' nucleotide of the intron was reported to contain an A instead of the G found in all other group I introns, *in vivo* autocatalytic activity was confirmed by polymerase chain reaction (PCR) analysis of terminase gene cDNA (Mikkonen and Alatossava, 1995).

A second putative group I intron has since been located in the genome of the *Lc. lactis* temperate bacteriophage r1t (Van Sinderen et al., 1996), and Foley and coworkers (2000) recently showed that many genetically and ecologically unrelated *S. thermophilus* phages contain a functional group I intron in their lysin gene. The latter work showed that although location of the intron was conserved among different phages, nucleotide sequence analysis revealed the existence of several variant introns. Two of these elements, represented by the 1013-bp introns in phages S3b and ST3, differ by a single nucleotide substitution and contain an open reading frame (ORF) encoding a 253-aa protein with good homology to other intron-encoded endonucleases. Three other variant introns, typified by the elements in phages Sfi6A, S92, and ST64, had deletions in the intron-encoded

ORF that yielded elements of 519, 443, and 316 bp, respectively. Another variant intron in phage DT1 differed from the S92 element by one nucleotide substitution (Foley et al., 2000). Since the intron-encoded endonuclease is required for mobility (Lambowitz and Belfort, 1993), it seems unlikely that any of the four latter variants would display homing activity.

b. Group II Introns Like their group I counterparts, many group II introns also contain ORFs. In contrast to the former class of introns, however, ORFs encoded by group II introns produce multidomain proteins with maturase and reverse transcriptase activities that are involved in self-splicing and mobility reactions, respectively (Dunny and McKay, 1999; Lambowitz and Belfort, 1993). Only one functional group II intron has been identified to date in LAB, but putative elements have also been identified in *En. faecalis* and *S. pneumoniae* (Dunny and McKay, 1999). The group II intron whose function has been studied is designated LI.ltrB, and it was independently discovered in a gene (*ltrB*) encoding conjugative relaxase by researchers studying the conjugative sex factor of *Lc. lactis* strains ML3 (pRS01) and 712 (Mills et al., 1996; Shearman et al., 1996). Both groups showed LI.ltrB had *in vivo* self splicing activity, and Mills et al. (1997) also demonstrated homing of the intron into an intron-free *ltrB* allele in *Lc. lactis*.

The latter observations are particularly significant, because LI.ltrB was the first functional group II intron to be identified in any bacterium, and its discovery has significantly advanced current understanding of group II intron biology. Analysis of the LI.ltrB homing pathway in *Es. coli* and *Lc. lactis*, for example, has provided new insight into the mechanism for group II intron mobility in bacteria (Dunny and McKay, 1999). The model that emerged from those studies suggests that homing occurs through a novel pathway that is initiated by staggered, double-strand DNA cleavage at the target site. Two endonuclease activities are required in this reaction: cleavage of the antisense strand is effected by the LI.ltrB intron-encoded protein and the sense strand is cut at the intron insertion locus by reverse splicing of the intron RNA. Both activities are found in ribonucleoprotein particles formed by the intron-encoded protein and intron RNA. After reverse splicing into the cut site, transposition is completed by cDNA synthesis from the intron template. Unlike group I intron homing, these reactions result in precise integration of the group II intron without coconversion of flanking 5' exon sequences. Group II intron mobility also differs in that it does not require RecA protein and has very relaxed requirements for flanking exon homology (Cousineau et al., 1998; Dunny and McKay, 1999).

Finally, these studies have also shown that domain IV of LI.ltrB is not essential for self-splicing and can accommodate foreign DNA inserts greater than 1 kb in length. This feature, coupled with the intron's relatively relaxed target specificity and absence of exon coconversion during transposition, indicate that LI.ltrB may be a useful tool for genetic engineering in bacteria and higher cells (Dunny and McKay, 1999).

C. Bacterial Chromosome

Genes encoding all of the essential housekeeping, catabolic, and biosynthetic activities of the cell are housed in the chromosome. As such, knowledge of chromosomal structure and organization in dairy LAB has great fundamental and applied value to the dairy industry. Recent advances in chromosomal mapping technologies and in nucleotide sequencing resources has sparked an intense interest in bacterial genome analysis, and chromosomes of LAB are certainly no exception.

Efforts to characterize chromosomes of LAB were begun in the early 1970s and 1980s by researchers who used DNA-DNA renaturation kinetics to estimate the genome size (in daltons) of *En. faecalis*, *Lc. lactis*, and pathogenic streptococci (Bak et al., 1970; Jarvis and Jarvis, 1981). Classic methods for gene exchange such as transduction and conjugation (see Sec. III.A and III.C) are not well suited to chromosomal mapping in LAB, so more detailed genome studies were not feasible until the advent of pulsed-electric field gel electrophoresis (PFGE) technology in the early 1980s (Le Bourgeois et al., 1993). This methodology allows one to purify relatively intact bacterial chromosomes, digest them with rare-cutting restriction endonucleases, then resolve the large molecular weight restriction products by electrophoresis in an alternating electric field. If appropriate size standards are included in the gel, summation of individual restriction fragments after PFGE provides a rapid and relatively accurate means to estimate genome size. By this approach, genome size estimates have now been collected for strains representing more than 15 species of LAB. These data show that LAB, like other nutritionally fastidious eubacteria, have a relatively small (approximately 1.8 to 3.4 megabase pairs) chromosome (Davidson et al., 1996). One of the practical observations to emerge from this work was that restriction fragment polymorphisms are common in the PFGE profiles from different strains of the same LAB species. This finding has led industry and academia to employ PFGE as a DNA fingerprinting tool for strain identification and for evaluation of strain lineage (Le Bourgeois et al., 1993).

Another important outcome of PFGE technology has been its use, in combination with other procedures such as Southern hybridization with specific gene probes, to assemble modest physical and genetic maps of LAB chromosomes. This strategy has been used to procure maps for chromosomes of several industrially important LAB, including *Lc. lactis* (Davidson et al., 1995; Le Bourgeois et al., 1992a; Tulloch et al., 1991), *O. oeni* (Ze-Ze et al., 1998), and *S. thermophilus* (Roussel et al., 1994), and for many of the pathogenic streptococci (Dmitriev et al., 1998; Gasc et al., 1991; Hantman et al., 1993; Suvorov and Ferretti, 1996). These maps have confirmed that individual species and even strains may differ in genomic size and organization, and show that all LAB characterized to date possess a single and circular chromosome.

Finally, PFGE has also facilitated the study of chromosomal geometry and intraspecific polymorphisms in *Lc. lactis* and *S. thermophilus*. Those investigations identified intraspecific genomic polymorphisms that have arisen by DNA inversions, insertions, deletions, and translocations, and they provided evidence that IS elements were involved in many of these events (Davidson et al., 1996; Leblond and Decaris, 1998; Roussel et al., 1997). As was noted in Sec. II.B, subsequent work has confirmed that a large genomic inversion in the chromosome of *Lc. lactis* ML3 was in fact produced by homologous recombination between IS905 elements.

As outlined in the preceding paragraphs, development and commercialization of PFGE technology gave rise to a new microbiological discipline whose subject involves structural, functional, and comparative analyses of bacterial genomes. Although PFGE analysis is still an important component of genome research, the most exciting and innovative work in this rapidly growing field is now being fueled by nucleotide sequence analysis of complete genomes.

1. Comparative Genomics

Compilation and annotation of entire genome sequences has revolutionized bacteriology and microbial genetics, and has created almost unimaginable opportunities to study bacterial evolution, genetics, physiology, and metabolism. Entire nucleotide sequences for more than 30 different microbial genomes have been published since 1995, and sequencing projects for over 100 other species are underway (see <http://www.tigr.org/tdb/mdb/mdb.html>). The dramatic growth in genome sequence research is largely the result of technical improvements in automated DNA sequencers, molecular biology tools, personal computers, and computer software, which now allow even small laboratories to engage in a bacterial genome project (Frangeul et al., 1999).

For obvious reasons, most of the microbial genome sequencing projects have focused on species with human clinical significance. It is therefore no surprise that sequencing projects among the LAB have targeted several important pathogens in this group (e.g., *En. faecalis*, *S. mutans*, *S. pyogenes*, and *S. pneumoniae*). Nonetheless, low-redundancy sequencing of the entire *Lc. lactis* genome was recently reported by Bolotin et al. (1999), and genome sequencing projects are underway for other important dairy LAB, including *Lb. acidophilus* and *Lb. helveticus*.

The value of genome sequence information from both food-grade and pathogenic LAB species to LAB research cannot be overstated. Such comprehensive knowledge will endow industry and academia with unprecedented power to determine the means by which LAB have evolved in, interact with, and respond to milk and cheese environments. It is important to note that sequence acquisition and annotation are only the first steps in functional genomics research. The physi-

ological role and regulation of most of the deduced ORFs must still be confirmed or identified, and this task could span several decades. Moreover, the speed at which LAB genomics research can progress will also hinge upon the time and degree to which genome sequences are made available to the general scientific community. Nonetheless, the fundamental and applied payoffs of genomic research to the dairy industry are too numerous to list, and many probably cannot yet be envisioned. A few examples of research outcomes that should be possible through this exciting work include:

1. Knowledge of global gene regulation and integrative metabolism in LAB would help answer long-standing questions regarding mechanisms for the health-promoting benefits of certain LAB; identify means by which some species grow in harsh environments; highlight the most rational strategies for metabolic and genetic improvements to industrial strains; and improve molecular biology resources for genetic manipulation of many dairy LAB species.
2. Comparative genomics will build a fundamental understanding of LAB evolution and taxonomy that will facilitate safety assurance evaluations of food-grade, genetically modified LAB; provide novel methods for isolation of new starter and adjunct LAB from different environments; and yield new strategies to combat the spread of virulence factors by pathogenic enterococci and streptococci.

D. Bacteriophages

Bacteriophages, or phages for short, are viruses that attack and destroy bacterial cells. The inhibitory effect of these obligate parasites on dairy starter bacteria has been recognized for more than 60 years, and their destructive impact on the cheese and yogurt industries has focused worldwide attention on molecular genetics and evolution of LAB phages. Because industrial fermentations with *Lc. lactis* and *S. thermophilus* starters suffer greatest economic losses, current understanding of LAB phage biology stems largely from phages infecting these two species (Brüssow et al., 1998; Garvey et al., 1995). However, several groups have described bacteriophages infecting other industrially important LAB species, including many dairy lactobacilli, and some of these phages have even been characterized at the genome sequence level (Altermann et al., 1999; Kodaira et al., 1997; Mikkonen et al., 1996). Taxonomically, a few phages with contractile tails (family Myoviridae) or very short tails (family Podoviridae) have been isolated from LAB, but most bacteriophages infecting these species belong to the Siphoviridae family (phages with long noncontractile tails) of the order Caudovirales (Brüssow et al., 1998; Caldwell et al., 1999; Davis et al., 1985; Díaz et al., 1992; García et al., 1997; Jarvis et al., 1991, 1993; Manchester, 1997; Park et al., 1998;

Séchaud et al., 1988; Trevors et al., 1983). A detailed description of LAB phage morphology, infectious cycles, and host range properties are provided in Chapter 6 of this volume and will not be addressed any further here. Instead, this section will highlight some of the exciting outcomes from molecular genetic research of LAB bacteriophages.

Unlike the LAB chromosome, where the promise of genomics research remains largely untapped, the structural, organizational, and evolutionary study of LAB bacteriophage genomes has progressed rapidly in recent years. The obvious reason for this difference is that phage genomes are much smaller (sizes range from 18 to 134 kb) (Prevots et al., 1990) than a bacterial chromosome, and can therefore be sequenced far more rapidly (and inexpensively). Two of the most significant outcomes of phage genetics and genomics studies include (1) a more comprehensive view of bacteriophage diversity and evolution in LAB and (2) application of phage-derived elements to enhance bacteriophage resistance in dairy starter bacteria and for genetic manipulation of these species.

1. On the Origin of Phages

The design of effective phage-control strategies for the dairy fermentation industry depends, to a large degree, on sound knowledge of bacteriophage diversity and evolution. The origin of phages in dairy plants has therefore been the subject of considerable research and debate, and one of the focal points of this discussion has been the role of lysogeny in evolution of virulent phages. As was outlined earlier (see Sec. II.B.1), Shimizu-Kadota and coworkers (1985) showed that a virulent *Lb. casei* phage clearly was derived from a prophage in the host starter bacterium by insertional transposition of *ISLI*. Discovery that lysogeny is quite common in dairy LAB, and especially in *Lc. lactis*, led to speculation that prophages may be an important reservoir of lytic bacteriophages in the dairy industry (Davidson et al., 1990). We now know that although virulent *Lc. lactis* phages can evolve from temperate phages (Davidson et al., 1990), most of the lytic and temperate phages that infect this species share very little DNA homology and therefore are not closely related (Garvey et al., 1995). An important exception involves lytic phages from the P335 species, which do exhibit DNA homology with temperate bacteriophages and whose frequency in cheese plants is increasing (Dumaz and Klaenhammer, 2000; Moineau et al., 1994; Walker et al., 1998). More significantly, new P335 lytic phages evolve by acquisition of host chromosomal DNA, and nucleotide sequence analysis of one of these fragments has confirmed it was derived from prophage components (Dumaz and Klaenhammer, 2000; Moineau et al., 1994).

In contrast to the situation in *Lc. lactis*, all lytic and temperate *S. thermophilus* bacteriophages characterized to date belong to a single DNA homology group (Brüssow et al., 1998), and comparative genomics has revealed that deletions in

the lysogenic module of temperate phages probably plays a key role in evolution of lytic phages (Lucchini et al., 1999a; Tremblay and Moineau, 1999). Fortunately, lysogeny appears to be quite rare in this species (Le Marrec et al., 1997). Lysogens are more common in dairy lactobacilli (Davidson et al., 1990), however, and a genetic relationship between lytic and temperate phages from some of these species has also been established (Auad et al., 1999; Lahbib-Mansais et al., 1988; Mikkonen et al., 1996; Shimizu-Kadota et al., 1985). As a whole, these data clearly show that lysogeny has an important (but not exclusive) role in evolution of new lytic phages in the dairy fermentations industry, and they argue for development of prophage-cured starter LAB (Shimizu-Kadota and Sakurai, 1982).

From a more fundamental perspective, comparative genomics studies of LAB Siphoviridae have also yielded rewarding insight into bacteriophage evolution and taxonomy. As is typical of tailed phages, all LAB phage genomes characterized thus far comprise a linear, double-stranded DNA molecule whose G + C content is parallel to that of the host (Ackermann, 1999). Depending upon the mechanism by which it is packaged into the capsid (which may differ even between very closely related bacteriophages), genomes from LAB Siphoviridae possess cohesive ends or circular permutation with terminal redundancy. Most phage ORFs appear to be transcribed from a common strand, except in temperate phages, where a cluster of genes associated with lysogeny is transcribed divergently from those that encode the lytic cycle (Altermann et al., 1999; Garvey et al., 1995; Klaenhammer and Fitzgerald, 1994; Kodaira et al., 1997; Le Marrec et al., 1997; Lucchini et al., 1999c; McShan and Ferretti, 1997; Mikkonen et al., 1996; Venema et al., 1999).

Efforts to further elucidate structure-function properties of LAB bacteriophage genomes have been hindered by the experience that protein homology searches rarely yield useful matches for more than a fourth of the phage-encoded ORF products (Desiere et al., 1999). Nonetheless, the structural organization of genes whose function is known or to which a putative role can be assigned has revealed that functionally related genes are distributed into clusters or modules whose order is highly conserved among very different phages (Altermann et al., 1999; Auad et al., 1999; Kodaira et al., 1997; Luccini et al., 1999b, 1999c; McShan and Ferretti, 1997; Mikkonen et al., 1996; Venema et al., 1999). In this regard, LAB bacteriophage genomic structure is quite consistent with the prevailing theory on phage evolution. This theory, termed the modular theory for phage evolution, was formulated to address the highly recombinogenic nature of bacteriophages which, of course, makes evolution by linear descent implausible (Botstein, 1980). By the modular theory, the product of evolution is not a particular virus but instead a family of interchangeable genetic modules which individually perform a specific biological function. Thus, individual viruses represent a combination of modules that have been selected for their singular and

coordinated ability to fill a particular niche. Exchange of one module for another with similar function occurs by recombination between bacteriophages that exist within a common, interbreeding population (and these viruses can differ widely in any characteristic except modular construction). Experience now suggests that single modules may be as small as one gene or even a gene fragment encoding the single domain of a protein (Luccini et al., 1999c).

A modular mechanism for LAB phage evolution is clearly evidenced by the recent work of Lucchini et al. (1999b), who showed that genomes of temperate Siphoviridae from all gram⁺ bacteria with a low G + C content display the following organization in their morphogenesis and lysogeny modules: DNA packaging–head morphogenesis–tail morphogenesis–tail fiber morphogenesis–lysis–lysogeny–DNA replication–followed by a module whose function has not been identified. The workers also noted that these phages may comprise a unique genus within the Siphoviridae family because even though their morphogenesis module is evolutionarily closest to the lambda-like Siphoviridae, their lysogeny module is actually more closely related to that of the P2-like Myoviridae.

Finally, it is important to recognize that since module structure is more highly conserved than nucleotide or amino acid sequences, similarities that exist between morphogenesis modules of lambdoid and LAB Siphoviridae can be exploited to assign putative functions to many LAB phage genes (Chandry et al., 1997; Desiere et al., 1999). Recent validation of this strategy by Desiere et al. (1999) should encourage structure–function research in LAB phage genomes that will eventually provide exciting new insight into the biology of LAB bacteriophages and phage–host interactions.

2. New Tools for Biotechnology of Lactic Acid Bacteria

Bacteriophage genomics research has also produced several novel phage defense mechanisms for dairy starter cultures. The first system to be described involved insertion of a bacteriophage origin of replication into a streptococcal shuttle vector (Hill et al., 1990). Lactococcal host cells that carry the recombinant plasmid display an abortive phage resistance phenotype called Per (for phage encoded resistance) that is proposed to act by titration of phage replication proteins away from true phage *ori* sequences during the early stages of infection (Hill et al., 1990; McGrath et al., 1999). Although the efficacy of Per-mediated phage resistance was originally established in *Lc. lactis*, recent work by Foley and coworkers (1998) suggests Per systems may actually have greater value in *S. thermophilus*. The reasons for this are twofold: first, very few natural phage defense systems are available for this species; and second, Per-type systems appear to confer relatively broad resistance against *S. thermophilus* phages (Foley et al., 1998). Other examples of phage defense systems that have been derived from bacteriophage genetics include (1) application of antisense mRNA against highly conserved *Lc. lactis* phage sequences (Kim and Batt, 1991; Walker and Klaenhammer, 2000); (2) a

system for *Lc. lactis* that places a suicide gene under control of a strictly phage-inducible promoter to trigger death of host cells upon infection (Djordjevic et al., 1997); and (3) a mechanism that imparts immunity to temperate phage superinfection in *Lb. casei* by constitutive host expression of the phage's gene for repressor protein (Alvarez et al., 1999).

Functional genomic analysis of LAB phages has also yielded a variety of useful tools for molecular genetic manipulation of dairy starter bacteria (Venema et al., 1999). For example, the integrase gene (*int*) and attachment sequence (*attP*) that mediate site-specific integration of temperate phages into the host chromosome have been utilized to develop integration vectors that insert foreign DNA into a specific locus (*attB*) on the bacterial chromosome. The *int-attP* integration systems offer several important advantages over counterparts that rely upon host-mediated homologous recombination. These include (1) integration occurs at *attB*, the locus normally used for prophage insertion, and is thus less likely to disrupt cellular functions or viability; (2) integrant stability is usually high under nonselective conditions; and (3) conservation of the *attB* sequence in different bacteria, or flexibility in its recognition by the *int-attP* cassette, permits use of these systems in a wide range of bacterial species (Alvarez et al., 1998; Auvray et al., 1997; Van de Guchte et al., 1994; Venema et al., 1999).

Bacteriophage regulatory sequences and lysin genes can also be useful elements for biotechnology. As an example, a rapidly inducible and efficient heterologous gene expression system for *Lc. lactis* has been developed by incorporation of a phage origin and middle promoter into a low copy number expression vector (O'Sullivan et al., 1996). The system is triggered by deliberate infection with an appropriate bacteriophage, which results in explosive vector replication (i.e., target gene amplification) coupled with phage-induced transcription of the target DNA. Other workers have isolated a phage repressor-operator region that encodes a mutant, temperature-sensitive repressor protein and demonstrated its use for temperature-inducible gene expression in *Lc. lactis* (Nauta et al., 1997). Finally, model studies indicate that phage lysin genes may have application in tightly regulated suicide cassettes designed to induce starter lysis for accelerated cheese maturation (De Ruyter et al., 1997).

III. GENE TRANSFER MECHANISMS

Modern genetics flows from the ability to manipulate living cells in ways that heritably alter their physiological properties. This achievement has become possible through discovery and refinement of gene transfer mechanisms in bacteria and higher cells. In this section, we will examine four types of gene transfer processes that have been established in dairy LAB: transduction, protoplast fusion, conjugation, and transformation. Although each has played some role in the genetic analysis of dairy LAB, transformation and, to a lesser extent, conjuga-

tion have clearly emerged as the most useful methods for genetic manipulation in these species.

A. Transduction

Transduction is a form of gene transfer which can result from inadvertent packaging of host DNA within a bacteriophage virion during phage replication. Genetic exchange is effected when the phage particle injects this DNA into another bacterium. Phage-mediated gene exchange in LAB was first described by Sandine et al. (1962), who noted transduction of tryptophan biosynthesis and streptomycin resistance markers by a virulent *Lc. lactis* bacteriophage. This work was significant in that it not only provided the first report of transduction in any LAB, it also represented the first gene transfer system to be identified in a species that was important to the fermented foods industry.

As a mechanism for gene transfer, transduction has been very useful for genetic studies in many bacteria, and it supported some of the first genetic experiments in the industrially important LAB. Researchers at the University of Minnesota, for example, used transducing temperate phages to establish that two industrially critical traits, lactose-fermenting ability (Lac^+) and proteinase activity (Prt^+), were encoded by plasmid DNA in *Lc. lactis* (McKay and Baldwin, 1974; McKay et al., 1976). This observation was important because (1) it provided a biological explanation for industry problems with stability of the acid-producing phenotype (which requires Lac^+ and Prt^+) in many dairy starter cultures (Sandine et al., 1962); and (2) it presented a simple genetic strategy to alleviate the problem. The latter point is illustrated by the follow-up work of McKay and Baldwin (1978), who isolated *Lc. lactis* transductants in which the lactose and proteinase genes had integrated into the chromosome, and demonstrated that integration dramatically enhanced the stability of these traits.

Plasmid transduction by virulent or temperate phages has also been demonstrated in *S. thermophilus*, *Lb. salivarius*, and *Lb. gasseri* (Mercenier et al., 1988; Raya et al., 1989; Toyama et al., 1971), but even though this form of gene transfer helped to establish important genetics principles in *Lc. lactis*, it has not found similar applications in other food-grade LAB. Much of the current disinterest in transduction as a tool for genetic studies or improvements in LAB stems from the relatively narrow host range of transducing phages and, more importantly, development of more effective gene transfer systems such as conjugation and transformation.

B. Protoplast Fusion

The protoplast fusion method of gene transfer is founded upon three key observations: (1) microbial or plant cell walls can be enzymatically removed without

deleteriously affecting viability; (2) intercellular membrane fusion can be effected in the presence of polyethylene glycol; and (3) fusants can regenerate a new wall on an appropriate medium. Appropriate selection after cell wall regeneration yields hybrid cells with phenotypic attributes from both parental cell types (Alfoldi, 1982). Gene transfer by protoplast fusion was first demonstrated in plants by Kao and Michayluk (1974), but the technology was soon extended to bacteria (Fodor and Alfoldi, 1976; Schaeffer et al., 1976).

The first protoplast fusion studies in LAB demonstrated exchange of both plasmid-encoded and chromosomally encoded traits between strains of *Lc. lactis* (Gasson, 1980; Okamoto et al., 1983). Reports of interspecific and even intergeneric gene exchange among LAB followed (Coconcelli et al., 1986; Iwata et al., 1986; Kanatani et al., 1990; Smith, 1985), and the method has even seen limited application for strain improvement (Stoianova et al., 1988). Overall, however, interest in protoplast fusion technology has never been high because of the need to establish stringent protoplast formation and regeneration conditions for individual strains (Alfoldi, 1982). Nonetheless, protoplast fusion may still be a useful method to combine desirable traits (e.g., production of inhibitors or phage defense systems) from distinct strains, species, or even genera into a single novel bacterium.

C. Conjugation

Conjugation is a natural form of gene transfer in bacteria that requires physical contact between viable donor and recipient cells. Because it facilitates horizontal gene exchange among populations of both related and unrelated microorganisms, conjugation has weighty implications on bacterial evolution and adaptation (Arber, 2000; Firth et al., 1996). Genes required for conjugative transfer are typically located on self-transmissible plasmids and conjugative transposons, but transfer of nonconjugative plasmids can also be effected via processes termed donation and conduction (Steele and McKay, 1989). The former process applies to nonconjugative plasmids that possess a specific sequence, called the origin of transfer (*oriT*), that is required for DNA mobilization. Transfer of these plasmids relies only upon *trans*-acting gene products from a conjugative element and not on cointegrate formation between the nonconjugative and conjugative elements. In contrast, plasmid transfer by conduction does require cointegration, because the nonconjugative molecule lacks a functional *oriT*. Conclusive evidence for plasmid mobilization by conduction is generally based on presence of cointegrate plasmids in recipient cells (Steele and McKay, 1989).

As a genetics tool for dairy LAB, conjugation has proved especially useful to study plasmid biology in *Lc. lactis* (Kondo and McKay, 1985; Steele and McKay, 1989). An important outcome of this work has been the finding that many industrially important traits, including lactose and casein utilization, bacte-

riophage resistance, and bacteriocin production, can be transferred by conjugation (Gasson and Fitzgerald, 1994). This situation is of great practical value to the dairy industry, because dairy LAB that are genetically improved by a "natural" process like conjugation are not subject to the regulatory and social constraints that shackle the application of recombinant DNA. As a result, several groups have used conjugation to genetically enhance bacteriophage resistance in commercial *Lc. lactis* starter cultures (Klaenhammer and Fitzgerald, 1994) (see Sec. IV.A for additional details).

Conjugation of native plasmids and chromosomal genes has not been documented as frequently among other dairy LAB, but the ability of many species to participate in conjugation has been established through interspecific and intergeneric transfers of broad host range plasmids such as pAM β 1. These observations imply that conjugation may help to support genetics research in the many strains of dairy LAB that still cannot be efficiently or reproducibly transformed (Gasson and Fitzgerald, 1994; Thompson et al., 1999). In addition, conjugation appears to be less sensitive than transformation to the size of the DNA to be transferred, so mobilizable cloning vectors for LAB should also facilitate experiments with relatively large DNA molecules. Systems for delivery of gene-cloning vectors by conjugation have been developed, but efforts fully to exploit the versatility of conjugation as a tool for dairy strain improvement would clearly benefit from a more holistic understanding of conjugal mechanisms in dairy LAB (Romero et al., 1987; Thompson et al., 1999).

At present, the most complete models for conjugation have emerged from studies of the fertility (F) plasmids in gram⁻ bacteria (Firth et al., 1996). From those and other models, we can divide conjugal gene transfer into four basic stages: (1) stable mating pair formation; (2) DNA mobilization; (3) DNA transfer; and (4) mating pair resolution. In gram⁻ cells, formation of stable cell-cell contact requires sex pili which are produced by the donor cell. Gram⁺ bacteria do not produce pili, however, so stable mating pair formation between LAB must be achieved through other mechanisms. In contrast, homologies between conjugation gene products and noncoding sequences required for DNA transfer suggest that DNA processing and transfer events which follow stable cell-cell contact may occur by similar mechanisms in gram⁻ and gram⁺ bacteria. This hypothesis is further supported by the fact that conjugation between gram⁻ and gram⁺ bacteria can occur bidirectionally (Trieu-Cuot et al., 1987, 1988).

In gram⁻ hosts, establishment of a stable mating pair is believed to produce an intracellular signal that initiates DNA mobilization. One strand of the conjugative DNA is cleaved by a conjugative relaxase at a specific locus (*nic*) within *oriT*, and a DNA helicase unwinds the nicked strand in the 5'-3' direction. The displaced strand is then transported into the recipient cell in single-stranded form, 5'-3', through a mating bridge that spans both cell membranes. Complementary strand synthesis in the donor and recipient relies on host enzymes and is thought

to occur as DNA transfer proceeds. Once DNA transfer is complete, the mating pair actively dissociates and the recipient assumes the conjugative phenotype of the donor cell (for a detailed discussion of conjugal mechanisms in gram⁻ bacteria, see Firth et al., 1996).

The biochemistry of DNA processing and transfer is not nearly as well understood in gram⁺ bacteria, and much of the information that is available is built from assumptions based on protein and nucleic acid sequence homologies. Two important exceptions to this theme involve mechanisms for efficient mating pair formation and DNA mobilization. In mating pair formation, very good models have emerged from studies of pheromone-inducible plasmid transfer in *En. faecalis* and, to a lesser extent, from the *Lc. lactis* sex factor (Dunny and Leonard, 1997; Gasson et al., 1995; Mills et al., 1998). Sound models for DNA mobilization in LAB have also come forward through studies of the streptococcal plasmids pIP501 and pMV158 (Grohmann et al., 1999; Wang and Macrina, 1995).

1. Mating Pair Formation in Lactic Acid Bacteria: Pheromones and Sex Factors

Unlike *Lc. lactis* and other dairy LAB, *En. faecalis* is a significant cause of human morbidity and mortality, and conjugation in this species is intimately associated with dissemination of antibiotic resistance genes and virulence factors (Dunny and Leonard, 1997). For these reasons, conjugation in *En. faecalis* has been studied intensively for more than two decades, and the pheromone-induced plasmid transfer system in this species is now one of the most thoroughly understood mechanisms for efficient mating pair formation in gram⁺ bacteria. Although *En. faecalis* is not and should not be used as a dairy starter bacterium, this mechanism has similarity to that used in lactose plasmid conjugation by *Lc. lactis* and therefore warrants some discussion here.

Several plasmid families and their distinct pheromones have been identified in *En. faecalis*, but the most thoroughly characterized plasmids are pAD1 and pCF10, which encode production of hemolysin and tetracycline resistance, respectively. Stable mating pair formation in *En. faecalis* cells containing one of these or another pheromone-induced conjugative plasmid is achieved by a protein-protein interaction that involves aggregation substance (AS) on donor cells and enterococcal binding substance on the recipients. The genetic determinant for AS production is located on pAD1, pCF10, and other pheromone-inducible plasmids, and its expression is induced (along with genes for other conjugative functions) by the presence of recipient-produced pheromone in the growth medium (Dunny and Leonard, 1997).

The *En. faecalis* sex pheromones are small (seven to eight amino acids in length), hydrophobic, and chromosomally encoded peptides. Most strains produce a number of distinct pheromones that individually can only act on cells that

contain a particular plasmid family member. Induction of pAD1 or pCF10 transfer is initiated by internalization of its cognate pheromone (cAD1 or cCF10) into donor cells via pAD1- or pCF10-encoded oligopeptide-binding proteins TraC or PrgZ, respectively, and the chromosomally encoded oligopeptide transport system (Opp). Once inside, the pheromone binds to an intracellular regulatory molecule, which then directs expression of pAD1- or pCF10-encoded conjugation genes. Interestingly, even though regulatory genes on pAD1 and pCF10 have a similar organization and even some DNA sequence homology, induction of plasmid-coded conjugation genes apparently occurs through very distinct routes (Dunny and Leonard, 1997). Nonetheless, induction results in AS production by donor cells, which leads to rapid cell aggregation and mating pair formation. After a recipient has successfully acquired any member of a particular plasmid family, production of the cognate pheromone for that family is essentially blocked, and the recipient assumes a conjugative phenotype identical to that of the original donor (Dunny and Leonard, 1997).

a. Lactococcal Sex Factor Sex pheromone production has not been detected in *Lc. lactis* or other dairy LAB, but efficient mating pair formation in the former bacterium is effected by a 135-kD cell surface protein, CluA, that has significant homology to the *En. faecalis* AS protein (Godon et al., 1994). The gene encoding this protein, *cluA*, is located on the conjugative plasmid pRS01 in strain ML3 and on a homologous but chromosomally integrated sex factor in the closely related strain 712. This element also encodes a conjugative relaxase whose gene (*ltrB*, which contains the group II intron described in Sec. II.B.3) lies just upstream of the pRS01 origin of transfer, as well as an enzyme (TraD) that has homology to an *Es. coli* F plasmid product believed to facilitate transportation of ssDNA into recipient cells (Firth et al., 1996; Gasson et al., 1995; Mills et al., 1998). The lactococcal sex factor shows great promise as a genetics tool for LAB, because it can consummate intergeneric conjugation between *Lc. lactis* and lactobacilli, leuconostocs, pediococci, *O. oeni*, and *S. thermophilus* (D.A. Mills, personal communication). Furthermore, as an integrated element in the host chromosome, the sex factor can reportedly mobilize chromosomal gene transfer in a counterclockwise direction (Gasson et al., 1995).

Discovery and characterization of the sex factor evolved from detailed studies of lactose plasmid conjugation in *Lc. lactis* ML3 and 712 (Dunny and McKay, 1999; Gasson et al., 1995). Lactose-fermenting ability (Lac⁺) in these two strains (and several others) is encoded by a nonconjugative 55-kb plasmid, but Lac⁺ can be transferred by conjugation to other lactococci at low frequency. Some Lac⁺ transconjugants from these donors form very tight cell aggregates (Clu⁺) and are able to transfer Lac⁺ in secondary matings at frequencies 10²- to 10⁵-fold higher than those obtained with the parental strains. Genetic analysis revealed that all Clu⁺ and some Clu⁻ transconjugants contained a novel 104-kb plasmid formed

by *ISS1*-mediated cointegration between the lactose plasmid (which carries two copies of the IS) and the sex factor. Further study showed lactose plasmid cointegration with the sex factor could occur in more than one orientation, and it was this feature that appeared to determine whether or not a transconjugant was Clu^+ (Dunny and McKay, 1999; Gasson et al., 1995). The mechanism(s) by which cointegrate formation induces *cluA* expression is not yet clear, but the absence of a consensus lactococcal promoter sequence immediately upstream of the *cluA* gene has led to speculation that it may involve a promoter in *ISS1* (Gasson and Fitzgerald, 1994; Godon et al., 1994). Other factors must also affect *cluA* expression, however, because high-frequency transfer of the sex factor itself has also been documented (Gasson, 1995). Nonetheless, the role of CluA in cell aggregation, and the influence of aggregation on conjugation efficiency, are well established (Anderson and McKay, 1984; Godon et al., 1994; Wang et al., 1994).

Additional evidence for a functional analogy between *En. faecalis* and *Lc. lactis* mechanisms for efficient mating pair formation was provided by Van der Lelie et al. (1991), who showed the Clu^+ phenotype in *Lc. lactis* may actually involve an interaction between CluA and another lactococcal cell surface component called aggregation substance (Agg). The genetic determinant(s) for Agg has not yet been identified, but the substance appears to be synthesized constitutively by many, although not all, lactococci. Thus, self aggregation only occurs when both cell surface components are expressed by the same bacterium, but efficient mating pair formation can occur between $\text{CluA}^- \text{Agg}^+$ recipients and donor cells that are either $\text{CluA}^+ \text{Agg}^+$ (phenotypically Clu^+) or $\text{CluA}^+ \text{Agg}^-$ (phenotypically Clu^-). Taken together, these and other reports of efficient conjugation systems in gram⁺ bacteria (Jensen et al., 1996; Reniero et al., 1992) indicate that protein-mediated donor and recipient aggregation may be an important mechanism for efficient mating pair formation in bacteria that do not produce pili.

2. DNA Mobilization

In contrast to mechanisms for mating pair formation, DNA mobilization in LAB and other gram⁺ bacteria appears to occur through a process very similar to that used by gram⁻ cells (Climo et al., 1996; Grohmann et al., 1999; Guzmán and Espinosa, 1997; Wang and Macrina, 1995). Mobilization begins with binding of a conjugative relaxase (frequently called a mobilization or Mob protein) at *oriT* to form a nucleoprotein complex called a relaxosome, which may or may not include additional proteins. All self-transmissible elements possess an *oriT*, and as was noted earlier, this *cis*-acting locus is also found on nonconjugative mobilizable plasmids (which also usually encode a *trans*-acting relaxase) that can be transferred by donation. The relaxosome initiates DNA transfer by cleaving one strand of the DNA at the *nic* locus, and then the relaxase remains bound to the 5' end of the *oriT* locus as DNA transfer proceeds. Biochemically, reactions surrounding

nucleophilic attack by the relaxase on a specific phosphodiester bond in *nic* bear a strong resemblance to those performed by Rep protein during initiation of rolling-circle plasmid replication (see Sec. II.A.1) (Guzmán and Espinosa, 1997).

Genes encoding conjugative relaxases and *oriT* regions (which typically are very close to one another) have been identified on self-transmissible and mobilizable elements in several LAB species (An and Clewell, 1997; Dougherty et al., 1998; Guzmán and Espinosa, 1997; Jaworski and Clewell, 1995; Mills et al., 1998; Van Kranenburg and De Vos, 1998; Wang and Macrina, 1995). Like *oriT* regions from other bacteria, most LAB *oriT* sequences contain a short conserved sequence that can be used to classify these elements into one of three homology groups represented by the *nic* regions from gram-F-like, IncP, and IncQ plasmids. Exceptions to this observation include the streptococcal plasmid pMV158 and a few other RCR plasmids in LAB, whose *oriT* regions encompass a homologous sequence named RS_A that is also involved in RCR plasmid cointegration (Guzmán and Espinosa, 1997). Nonetheless, all of the *oriT* sequences that have been characterized in LAB (including members of the pMV158 family) contain a nonconserved inverted repeat immediately upstream of the conserved *nic* region (Table 3). A similar structural arrangement exists in the *oriT* regions of gram⁻ plasmids, where the inverted repeat is thought to be involved in termination of DNA transfer (Lanka and Wilkins, 1995).

Mobilization of nonconjugative DNA in LAB can also occur by conduction. The most extensively characterized event of this type in dairy LAB is lactose plasmid conduction by the *Lc. lactis* sex factor (see Sec. III.C.1), where plasmid cointegration is mediated by either of two *ISSI* elements on the lactose plasmid. Natural conduction of other plasmids following IS-mediated cointegration has also been reported in this species (Romero and Klaenhammer, 1990).

In addition, plasmid cointegrates can be produced by homologous recombination between conjugative and nonconjugative elements, and systems based on this type of plasmid mobilization have been used to transfer gene cloning vectors to various LAB that resist transformation (Romero et al., 1987; Smith and Clewell, 1984; Thompson et al., 1999). Very efficient plasmid conduction can also be induced through cointegration of the conjugative streptococcal plasmid pIP501 with nonconjugative plasmids that are provided with a short, palindromic, recombinational "hot spot" from pIP501 (Langela et al., 1993).

In summary, conjugation is an important instrument for biotechnology in dairy LAB because it provides researchers with a food-grade mechanism for genetic strain improvements, and because it can facilitate genetics research in strains that are difficult to transform. As was noted at the beginning of this section, however, efforts to exploit the versatility of conjugation for these purposes would be served from a more complete understanding of conjugation in LAB. Though much can be inferred from protein and nucleic acid sequence homologies that exist between conjugation systems of gram⁺ and gram⁻ bacteria, it is important

Table 3 Representative Structures for the Origin of Conjugative Transfer (*oriT*) in Lactic Acid Bacteria^a

Host genus and element	Type ^b	Nucleotide sequence (5'-3')	<i>oriT</i> Family ^c (reference)
<i>Enterococcus</i> <i>Tn916</i> ^d	c	 CAGTCCACGCAGGCGACGTGCGAAGCGGAAGTCGCAGGTGTGGACTGATCTTGCT	F-like (Jaworski and Clewell, 1995)
pAD1	c	 AGGGTATGAAAATCATACCCTGCCAAA	IncP (An and Clewell, 1997)
<i>Lactobacillus</i> pLAB1000 ^e	m	 ACTTTATAACATAAAGTATAGTGGGTTATACTTTA	pMV158 (Josson et al., 1990)
<i>Lactococcus</i> pRS01 ^f	c	 TTTTTTAACATTGTAAACAAGCTCATTGCGCCCCCTCCTTC	IncQ (Mills et al., 1998)
pNZ4000 ^g	m	 ACATTGTAATACAAGAACGAAGTGATTTGTATTACAATGTGATAGCTTGCAGTA	IncP (Van Kranenburg and De Vos, 1998)
<i>Streptococcus</i> pIP501	c	 ATACGAAGTAACGAAGTTACTGCGTATAAGTGCGCCTTAGT	IncQ (Wang and Macrina, 1995)
pMV158	m	 ACTTTATGAATATAAAGTATAGTGTGTTATACTTTACATG	pMV158 (Guzmán and Espinosa, 1997)

^a Inverted repeat sequences and defined *nic* sites are indicated by horizontal and vertical arrows, respectively.

^b Abbreviations: c = conjugative (self-transmissible), m = mobilizable.

^c Classification scheme based on nucleotide sequence homology to *oriT* regions from gram-negative F-like, IncP, or IncQ plasmids, or from the streptococcal plasmid pMV158.

^d The *Tn916 oriT* has been localized to a 466-bp fragment, but the sequence displayed is actually one of three sites in this region that show homology to the *nic* regions of F-like (shown) or IncP plasmids.

^e Identification of this *oriT* region is based entirely on sequence homology to pMV158 (Guzmán and Espinosa, 1997).

^f The pRS01 *oriT* has been localized to a 446 bp *PstI-XbaI* fragment, but the displayed sequence is actually one of five sites within this region that show homology to the *nic* regions of IncQ (shown), F-like, or IncP plasmids.

^g pNZ4000 contains two identical and functional copies of this sequence.

to recognize that many conjugation genes from LAB lack significant homology to any known proteins. Although these observations may largely reflect the mechanistic differences that are imposed by absence of pili, it is also plausible that some processes for DNA transfer and mating pair resolution in gram⁺ bacteria are quite different from those seen in gram⁻ cells and even from one another (Dougherty et al, 1998; Wang and Macrina, 1995). For this reason, it is encouraging to note recent growth in nucleotide sequence data for conjugal elements in dairy LAB (Burrus et al., 2000; Dougherty et al., 1998; Godon et al., 1994; Mills et al., 1996, 1998; Van Kranenburg and De Vos, 1998), because this information should stimulate more fundamental examinations of conjugation in these very important bacteria.

D. Transformation

Transformation is the process wherein free DNA molecules are introduced into cells. The power of an efficient and reproducible transformation system is that it permits us to manipulate genes *in vitro* and then analyze the consequences on *in vivo* molecular and cellular functions. Many bacteria, including some species of nondairy streptococci, can assume a “competent” state that allows them to take up DNA from their environment (Havarstein et al., 1997). This ability is determined by a set of unique genes that encode proteins for extracellular DNA binding, uptake, and integration. Expression of host competence genes is induced when the concentration of a host-secreted, competence-stimulating peptide (i.e., a competence pheromone) in the medium reaches a critical threshold. Natural competence has not been demonstrated in any of the food-grade LAB, but Bolotin et al. (1999) recently reported that the *Lc. lactis* genome appears to contain a complete set of competence genes.

In the absence of natural competence, the most effective method for transformation in most bacteria is electroporation. When cellular membranes are exposed to a high-voltage electric field, they become polarized and a voltage potential develops across the membrane. Electroporation technology is based upon the discovery that when this potential exceeds a certain threshold, localized breakdown of the membrane forms pores that render the cell permeable to extraneous molecules (Ho and Mittal, 1996). Under conditions that may be established experimentally, pore formation is reversible and cells remain viable. The mechanism for entry of DNA or other molecules into cells by electroporation is still unknown, but the availability of inexpensive and reliable commercial equipment has made electroporation the method of choice for transformation of many bacteria, fungi, and higher cells (Lurquin, 1997).

The first reports of transformation by electroporation (electrotransformation) in dairy LAB appeared in 1987, and by the end of that decade the technology

had been successfully applied to *Lc. lactis*, *S. thermophilus*, and many species of *Lactobacillus* and *Leuconostoc* (Chassy and Flickinger, 1987; David et al., 1989; Harlander, 1987; Hashiba et al., 1990; Luchansky et al., 1988; Powell et al., 1988; Somkuti and Steinberg, 1988). One of the most encouraging observations to emerge from this and subsequent research is that a single electroporation protocol can often effect transformation of different strains and even different genera of LAB. Thus, even though parameters for optimal electrotransformation of an individual strain will usually need to be established, a general protocol can frequently provide the starting point for such research.

Another important finding is that electrotransformation frequencies are frequently higher and more reproducible if the thick murein layer is weakened before electroporation (Bhowmik and Steele, 1993; Buckley et al., 1999; Dunny et al., 1991; Hashiba et al., 1990; Holo and Nes, 1989; Posno et al., 1991; Powell et al., 1988; Walker et al., 1996; Wei et al., 1995). This is usually achieved by propagating cells in a medium that contains relatively high concentrations of glycine or D/L-threonine, which interfere with cell wall synthesis and assembly. It should be recognized, however, that inhibition of cell wall synthesis is not essential for efficient electroporation of some LAB, and in certain instances it may even be counterproductive (Berthier et al., 1996; Luchansky et al., 1988; Marciset and Mollet, 1994; Wycoff et al., 1991).

Today, representative strains from virtually all industrially important dairy LAB species have been successfully transformed by electroporation, but individual strains from some species—and particularly lactobacilli—are still difficult or even impossible to transform by any known method. Moreover, even among LAB that can be electroporated, only a very few strains can be reproducibly transformed at frequencies greater than 10^4 transformants per microgram of exogenous DNA (Berthier et al., 1996; Holo and Nes, 1989; Marciset and Mollet, 1994; Posno et al., 1991; Wycoff et al., 1991). Some factors that appear to limit efficiency of electrotransformation in LAB include (1) culture growth phase, concentration, and membrane lipid composition; (2) host-encoded restriction/modification systems; and (3) vector size, purity, and compatibility with endogenous host plasmids (Aukrust and Blom, 1992; Hashiba et al., 1990; Luchansky et al., 1988; Posno et al., 1991; Van der Lelie et al., 1988). Regardless of its molecular basis, the broad variability in electrotransformation efficiency that exists among dairy LAB is unfortunate, because the proficiency at which cells can be transformed is directly related to the ease and flexibility by which recombinant DNA technologies can be employed for genetics research. It is largely for this reason that many LAB researchers pursue a strategy wherein gene cloning and characterization are done in *Es. coli*, where electrotransformation efficiencies commonly exceed $10^8/\mu\text{g}$ DNA, after which time DNA constructs are moved into the LAB of interest by electroporation. This approach suffers from several limitations,

however, and genetics research in dairy LAB would clearly profit from a more fundamental understanding of electrotransformation in these species.

1. Gene Delivery Systems

Vectors for gene cloning in dairy LAB can be divided into two fundamental categories: (1) extrachromosomal vectors that maintain cloned DNA on an autonomously replicating plasmid and (2) integrative vectors that are designed to insert cloned DNA into the host chromosome. The definitive differences between these elements are that the latter group are incapable of independent replication in the host species of interest (i.e., suicide vectors), and they contain specific sequences that promote vector integration into the host chromosome (see below). Some features common to both types of cloning vectors include (1) they encode a selectable phenotype that allows transformed cells to be easily distinguished from nontransformed cells; (2) they possess a "multiple cloning region" that is rich in unique restriction endonuclease cleavage sites and where foreign DNA can be inserted into the vector without damage to replication/integration or selection functions; and (3) they are usually small so that recombinant constructs can be more easily transformed into host cells. Some cloning vectors will also encode a second selective phenotype that is abolished by DNA insertions in the multiple cloning region. Loss of that phenotype is then used to discern transformants that contain recombinant molecules from those that only acquire vector DNA.

a. Replicative Vectors The first cloning experiments in dairy LAB employed replicative vectors that were developed for nondairy streptococci and enterococci, but a number of high- and low-copy number replicative vectors have since been built from the RCR and theta plasmid replicons found in dairy species (De Vos and Simons, 1994; Kondo and McKay, 1985; Von Wright and Sibakov, 1998; Wang and Lee, 1997). Many of these vectors (particularly those based on RCR replicons) (see Sec. II.A.1) have a broad host range and therefore offer the added advantage of serving as shuttle vectors for *B. subtilis* or *Es. coli*, where DNA manipulation techniques are particularly well established.

In addition to simple replicative vectors, identification and characterization of LAB gene expression signals and regulatory sequences has permitted construction of more specialized cloning vectors designed to facilitate constitutive or inducible expression of foreign DNA or heterologous protein secretion (De Vos and Simons, 1994; Kahala and Palva, 1999; Kok, 1996; Savijoki et al., 1997; Venema et al., 1999). Access to effective gene expression and protein secretion systems for dairy LAB is a particularly important advancement, because one of the most economically significant applications of biotechnology involves use of microorganisms to produce large amounts of industrially useful proteins. The worldwide industrial enzyme market, for example, has a value in excess of

\$1.2 billion per year (excluding pharmaceutical uses) with food industry applications comprising 40% of this market (Williams, 1998). Most of these enzymes are produced by fermentation with genetically modified bacteria, yeasts, and molds, and it is reasonable to assert that food-grade microorganisms such as dairy LAB may offer unique advantages as unicellular factories for production of enzymes (or other proteins) that are intended for use in human food.

b. Integrative Gene Cloning As is outlined in Section II.A.1, native plasmids and replicative vectors are vulnerable to segregational and structural stability problems that can result in permanent loss of plasmid-coded traits. Integration vectors avoid this problem by recombining with the host chromosome. These constructs are typically assembled in a permissible host such as *Es. coli*, and then transferred by electroporation into the (nonpermissive) LAB of interest. Two mechanisms that have been used to direct random or site-specific vector integration into the LAB chromosome include IS-mediated transposition and the *int-attP* functions from temperate bacteriophages, respectively (see Sec. II.B and II.D.2 for details and references). The most common scheme for vector integration in dairy LAB, however, relies on host mechanisms for homologous DNA recombination (Leenhouts, 1990). These systems typically contain a fragment of the LAB host chromosome which serves as a substrate for site-specific, homologous DNA recombination via single- or double-strand crossover. Single crossover recombination results in integration of the entire vector, whose sequence will be flanked by direct repeats of the cloned chromosomal fragment. One of the consequences of single crossover plasmid integration is that the homologous repeats formed by integration make the entire structure susceptible to gene amplification.

In contrast, double crossover recombination results in the exclusive integration of vector sequences that lie between the two recombination sites, with concomitant loss of the corresponding region of the native host chromosome and any extraneous vector sequences. Thus, double crossover recombination is often called replacement recombination. Unfortunately, replacement recombination is a low-frequency event, which limits its application in strains that suffer from a poor transformation efficiency. To overcome this problem, many researchers have abandoned suicide replicons in favor of vectors that display conditional (e.g., temperature-sensitive) replication in the LAB host of interest (Bhowmik and Steele, 1993; Low et al., 1998; Maguin et al., 1992). With these molecules, transformation efficiency and integration events can be uncoupled as transformants are selected under conditions that permit autonomous replication. Next, single crossover integrants are obtained by shifting a population of transformants to nonpermissive conditions, and then a second crossover event is stimulated by returning integrants to the permissive environment.

Aside from their applications in DNA cloning, integration vectors—partic-

ularly those that effect replacement recombination—are also invaluable to functional genetics research. This is because they facilitate the construction, by gene knockouts, of isogenic mutants that differ only by the action of a single polypeptide. By comparing the wild-type culture to its isogenic derivative, the role of that polypeptide (and its gene) in LAB cellular or industrial processes can be unequivocally established.

c. Food-Grade Gene-Cloning Systems More than two decades of intensive and worldwide research efforts have given us a tremendous understanding of biochemistry and genetics in dairy LAB. Important biochemical pathways have been elucidated, gene transfer systems have been developed for many strains, a great number of important genes (even entire chromosomes!) have been characterized at the nucleotide sequence level, and mechanisms for gene expression and protein secretion have been identified. To apply this knowledge toward industrial strain improvements, however, it is imperative that we have gene-delivery systems that of themselves do not present a safety concern in human food applications. The most important attributes of these systems, which are termed food-grade vectors, is that they be genetically well defined and not impart any antibiotic resistance gene to the host bacterium. The latter requirement is readily met by vectors that effect replacement recombination, but integrative or replicative gene-delivery systems whose selectable marker will be retained in the host must encode a food-grade alternative to antibiotic resistance. Examples of food-grade selection systems that have been used to satisfy this requirement include auxotrophic complementation, resistance to nisin or other LAB bacteriocins, and ability to ferment new carbohydrates (Allison and Klaenhammer, 1996; De Vos and Simons, 1994; Hashiba et al., 1992; Leenhouts et al., 1998; Lin et al., 1996; Sørensen et al., 2000).

IV. GENETIC IMPROVEMENT OF INDUSTRIAL DAIRY LACTIC ACID BACTERIA

Modern genetics research is founded upon the power to establish cellular and molecular functions through DNA manipulation, and LAB played an important role in the origin of this technology. In their landmark research on the “transforming principle” of *S. pneumoniae*, Avery and coworkers (1944) not only proved that DNA was the molecule of heredity, they also recognized the distinction between genetic material (DNA) and products of its expression (in this instance a capsular exopolysaccharide). In his discussion, Avery wrote:

Thus, it is evident that the inducing substance and the substance produced in turn are chemically distinct and biologically specific in their action . . .”; that these induced changes “are predictable, type-specific, and heritable.”;

and therefore “If . . . desoxyribonucleic acid actually proves to be the transforming principle. . . , then nucleic acids of this type must be regarded not merely as structurally important but as functionally active in determining the biochemical activities and specific characteristics of pneumococcal cells.

Today, our ability to manipulate animals, plants, and microorganisms genetically to manufacture, modify, or improve products or processes has blossomed into a multibillion dollar enterprise that has revolutionized pharmaceutical, chemical, and agricultural industries. Many of the most exciting and successful industrial applications of biotechnology involve microbial products or whole microorganisms. In the agricultural sector, for example, microbial biotechnology has become an integral component of modern plant and animal production, agricultural waste management, and food processing operations. Although many of these applications rely on naturally occurring cells or cell products, use of recombinant DNA-derived microbial products in agricultural and food systems is now commonplace. However, a similar statement does not apply to live, genetically modified microorganisms (GMMs), whose applications in food and agriculture has essentially been drowned in a whirlpool of scientific, political, and social controversies. The undercurrents that created this vortex are complex and beyond the scope of this chapter; suffice it to say that in addition to scientific and regulatory hurdles, the sociopolitical climate regarding use of recombinant DNA technology in food systems ranges from outright opposition (e.g., Western Europe, Australia, and New Zealand) to cautiously acquiescent (e.g., North America and parts of Asia). A variety of genetically modified agricultural plants are now in commercial production in the latter countries, but general opposition to genetic engineering in agriculture will probably continue to resonate through the sociopolitical agendas of most other states for years to come. Change will come, but it will come faster if academicians, industry scientists, and governmental representatives work to facilitate open and reasoned public discussion on risks and benefits of biotechnology in agriculture, and to promulgate sound scientific guidelines and policies.

As we consider commercial applications for genetically modified starter LAB, it is important to recognize a few basic principles: (1) dairy starter technology can be traced to the late 19th century, and the long history of safe application of LAB in human food means dairy starter bacteria have GRAS status (generally regarded as safe for use in food by governmental regulatory agencies such as the U.S. Food and Drug Administration); (2) our knowledge of LAB genetics and physiology has already identified very clear strategies to improve the industrial performance of dairy LAB; and (3) many of these improvements can be effected by mutation or natural gene transfer (e.g., conjugation). From this perspective, one can envision several simple, yet industrially valuable, genetic alterations to dairy LAB that do not undermine the GRAS status of these bacteria or influence the nutritional composition of fermented dairy foods. Two examples of genetic

improvements that meet these criteria involve intraspecific transfer of native plasmids and by directed metabolic engineering through natural mutation.

A. Enhanced Phage Resistance by Intraspecific Transfer of Native Plasmids

As noted in Table 1 and Section III.C, bacteriophage resistance is one of several industrially important traits that may be encoded by plasmid DNA in lactococci, and many lactococcal phage resistance plasmids can be transferred by conjugation (Klaenhammer and Fitzgerald, 1994). Since conjugation is a natural form of gene transfer, dairy LAB that are genetically improved by this process do not command the regulatory and sociopolitical attention that is directed toward recombinant DNA technology. Sanders and coworkers (1986) were the first to capitalize on this fortuitous situation when they introduced pTRK2030, a conjugative lactococcal plasmid that encodes restriction/modification and abortive infection phage defense mechanisms, into commercial Cheddar cheese starter bacteria. This general strategy has since been emulated by other researchers (Klaenhammer and Fitzgerald, 1994), and conjugation-derived, bacteriophage-insensitive dairy starter cultures have been commercially available for many years.

Conjugation has also been used to obtain strains that contain two or more plasmids encoding complementary phage defense systems (Klaenhammer and Fitzgerald, 1994). This capability led Sing and Klaenhammer (1993) to propose an ingenious phage resistance strategy that is based upon rotation of different restriction/modification and abortive phage defense mechanisms within a single-strain *Lc. lactis* starter background. Those investigators showed that rotation of isogenic phage-resistant derivatives—which differ in the types and specificities of phage defense mechanisms they encode—not only thwarts bacteriophage proliferation, it actually removes contaminating phages from the culture medium (because of the combined action of multiple abortive phage defense systems). By restricting the starter system to a single strain, this strategy also acts to reduce the potential for emergence of new phages in the dairy processing environment.

Although intraspecific conjugation of native phage resistance plasmids has been of great benefit to the dairy industry, the flexibility of this strategy is clearly limited to plasmids that are self-transmissible or mobilizable (see Sec. III.C). In some countries, this limitation has been overcome by electroporation with native phage resistance plasmids, and starter lactococci that have been improved by this process are now in widespread commercial use.

B. Metabolic Engineering for Diacetyl Production

Diacetyl is an industrially important “buttery” flavor and aromatic compound that is derived from citrate metabolism by LAB. Recent advances in our under-

standing of the genetics of citrate metabolism and mechanisms for diacetyl production have yielded several useful strategies to metabolically engineer *Lc. lactis* strains for enhanced diacetyl production (De Vos, 1996). One of the most promising avenues toward this goal involves inactivation of the gene encoding α -acetolactate decarboxylase (*aldB*), the enzyme that converts α -acetolactate to acetoin (see Fig. 10 in Chap. 7). This approach results in accumulation of α -acetolactate, the immediate precursor to diacetyl, which in turn leads to an increased concentration of diacetyl in the growth medium.

Inactivation of *aldB* can, of course, be directly achieved by replacement recombination (Swindell et al., 1996), but naturally occurring *aldB* mutants can also be isolated by growth selection in a medium that contains leucine but not valine. The latter approach is possible because α -acetolactate also serves as an intermediate compound in biosynthesis of leucine and valine, and leucine is an allosteric activator of α -acetolactate decarboxylase (Goupil-Feuillerat et al., 1997). Thus, wild-type lactococci cannot grow in such a medium, because leucine stimulates conversion of α -acetolactate to acetoin, leaving none to support valine biosynthesis. Any *aldB* mutants in the population, however, are able to synthesize valine in the presence of leucine and so will continue to grow. Regrettably, the industrial utility of this strategy is rather limited, because most commercial *Lc. lactis* strains are auxotrophic for branched-chain amino acids. To overcome this limitation, Curic et al. (1999) developed an inventive strategy wherein industrial strains are first transformed with recombinant plasmid-encoding enzymes for branched-chain amino acid biosynthesis. Selection for naturally occurring *aldB* mutants in the transformants can then be done as outlined above, and food-grade variants of that population obtained by subsequent plasmid curing. Since the final product of this work is a completely natural mutant that lacks any foreign DNA, strains that are improved by this approach are likely to see commercial application in the very near future.

V. SUMMARY

Academic and industrial research efforts over the last quarter century have generated a solid appreciation for the physiology and genetics of dairy LAB. Most recent and significant advances in LAB physiology are derived from studies made possible by recombinant DNA technology. The great advantage of this technology in analysis of cellular and industrial processes of LAB is that it facilitates construction of isogenic mutants that differ only by the action (knockout mutants) or relative activity (overexpression mutants) of one or more defined polypeptides. By contrasting the phenotype of the wild-type culture to its isogenic derivative, the role of that polypeptide in a given process can often be explicitly defined. The knowledge that is accumulated from this work can then be used to isolate or construct, by several different mechanisms, new strains with enhanced industrial

utility. This approach has already provided industry with strains that are better able to resist bacteriophage infection or produce higher levels of diacetyl. With the advent of food-grade recombinant DNA technologies, the potential for commercialization of value-added LAB that have been developed through gene additions, modifications, or deletions, is truly great. With this knowledge base, it is anticipated that the dairy industry will soon see more widespread application of genetic technologies in ways that provide innovation and vitality to the fermented milk industry for years to come.

REFERENCES

- Ackermann HW. Tailed bacteriophages: the order *Caudovirales*. *Adv Virus Res* 51:135, 1999.
- Actis LA, Tolmasky ME, Crosa JH. Bacterial plasmids: replication of extrachromosomal genetic elements encoding resistance to antimicrobial compounds. *Front Biosci* 4: D43, 1999.
- Alegre MT, Rodriguez MC, Mesas JM. Nucleotide sequence analysis of pRS1, a cryptic plasmid from *Oenococcus oeni*. *Plasmid* 41:128, 1999.
- Alfoldi L. Fusion of microbial protoplasts: problems and perspectives. In: Hollaender A, DeMoss RD, Kaplan S, Konisky J, Savage D, Wolf RS, eds. *Genetic Engineering of Microorganisms for Chemicals*. New York: Plenum Press, 1982, p 59.
- Allison GE, Klaenhammer TR. Functional analysis of the gene encoding immunity to lactacin F, *lafI*, and its use as a *Lactobacillus*-specific, food-grade genetic marker. *Appl Environ Microbiol* 62:4450, 1996.
- Altmann E, Klein JR, Henrich B. Primary structure and features of the genome of the *Lactobacillus gasseri* temperate bacteriophage Øadh. *Gene* 236:333, 1999.
- Alvarez MA, Herrero M, Suárez JE. The site-specific recombination system of the *Lactobacillus* species bacteriophage A2 integrates in gram-positive and gram-negative bacteria. *Virology* 250:185, 1998.
- Alvarez MA, Rodríguez A, Suárez JE. Stable expression of the *Lactobacillus casei* bacteriophage A2 repressor blocks phage propagation during milk fermentation. *J Appl Microbiol* 86:812, 1999.
- An FY, Clewell DB. The origin of transfer (*oriT*) of the enterococcal, pheromone-responding, cytotoxin plasmid pAD1 is located within the *repA* determinant. *Plasmid* 37:87, 1997.
- Anderson DG, McKay LL. Genetic and physical characterization of recombinant plasmids associated with cell aggregation and high frequency conjugal transfer in *Streptococcus lactis* ML3. *J Bacteriol* 156:954, 1984.
- Arber W. Genetic variation: molecular mechanisms and impact on microbial evolution. *FEMS Microbiol Rev* 24:1, 2000.
- Arihara K, Luchansky JB. Dairy lactobacilli. In: Hui YH, Khachatourians GG, eds. *Food Biotechnology: Microorganisms*. New York: VCH, 1995, p 609.
- Auad L, Raisanen L, Raya RR, Alatosava T. Physical mapping and partial genetic characterization of the *Lactobacillus delbrueckii* subsp. *bulgaricus* bacteriophage lb539. *Arch Virol* 144:1503, 1999.

- Aukrust T, Blom H. Transformation of *Lactobacillus* strains used in meat and vegetable fermentations. *Food Res Int* 25:253, 1992.
- Auvray, F, Coddeville M, Ritzenthaler P, Dupont L. Plasmid integration in a wide range of bacteria mediated by the integrase of *Lactobacillus delbrueckii* bacteriophage mv4. *J Bacteriol* 179:1837, 1997.
- Avery OT, MacLeod CM, McCarty M. Studies on the chemical nature of the substance inducing transformation of pneumococcal types: Induction of transformation by a desoxyribonucleic acid fraction isolated from *Pneumococcus* type III. *J Exp Med* 79:137, 1944.
- Axelsson L. Lactic acid bacteria: classification and physiology. In: Salminen S, von Wright A, eds. *Lactic Acid Bacteria: Microbiology and Functional Aspects*. 2nd ed. New York: Marcel Dekker, 1998, p 1.
- Bak AL, Christiansen C, Stenderup A. Bacterial genome sizes determination by DNA renaturation studies. *J Gen Microbiol* 64:377, 1970.
- Belfort M, Reaban ME, Coetzee T, Dalgaard JZ. Prokaryotic introns and inteins: a panoply of form and function. *J Bacteriol* 177:3897, 1995.
- Benachour A, Frere J, Flahaut S, Novel G, Auffray Y. Molecular analysis of the replication region of the theta-replicating plasmid pUCL287 from *Tetragenococcus (Pediococcus) halophilus* ATCC33315. *Mol Gen Genet* 255:504, 1997.
- Berthier F, Zagorec M, Champomier-Verges M, Ehrlich SD, Morel-Deville F. Efficient transformation of *Lactobacillus sake* by electroporation. *Microbiology* 142:1273, 1996.
- Bhowmik T, Marth EH. Role of *Micrococcus* and *Pediococcus* species in cheese ripening: a review. *J Dairy Sci* 73:859, 1990.
- Bhowmik T, Steele JL. Gene replacement in *Lactobacillus helveticus*. *J Bacteriol* 175: 6341, 1993.
- Biet F, Cenatiempo Y, Fremaux C. Characterization of pFR18, a small cryptic plasmid from *Leuconostoc mesenteroides* ssp. *mesenteroides* FR52, and its use as a food grade vector. *FEMS Microbiol Lett* 179:375, 1999.
- Bolotin A, Mauger S, Malarme K, Ehrlich SD, Sorokin A. Low-redundancy sequencing of the entire *Lactococcus lactis* IL1403 genome. *Antonie van Leeuwenhoek* 76:27, 1999.
- Botstein D. A theory of modular evolution for bacteriophages. *Ann NY Acad Sci* 354: 484, 1980.
- Bourgoin F, Guédon G, Pebay M, Roussel Y, Panis C, Decaris B. Characterization of a mosaic *ISS1* element and evidence for the recent horizontal transfer of two different types of *ISS1* between *Streptococcus thermophilus* and *Lactococcus lactis*. *Gene* 178:15, 1996.
- Bourgoin F, Guédon G, Gintz B, Decaris B. Characterization of a novel insertion sequence, *IS1194*, in *Streptococcus thermophilus*. *Plasmid* 40:44, 1998.
- Bourgoin F, Pluvinet A, Gintz B, Decaris B, Guedon G. Are horizontal transfers involved in the evolution of the *Streptococcus thermophilus* exopolysaccharide synthesis loci? *Gene* 233:151, 1999.
- Brisson-Noel A, Arthur M, Courvalin P. Evidence for natural gene transfer from gram-positive cocci to *Escherichia coli*. *J Bacteriol* 170:1739, 1988.
- Brito L, Paveia H. Presence and analysis of large plasmids in *Oenococcus oeni*. *Plasmid* 41:260, 1999.

- Broadbent JR, Kondo JK. Genetic construction of nisin-producing *Lactococcus lactis* subsp. *cremoris* and analysis of a rapid method for conjugation. *Appl Environ Microbiol* 57:517, 1991.
- Broadbent JR, Sandine WE, Kondo JK. Characteristics of Tn5307 exchange and intergeneric transfer of genes associated with nisin production. *Appl Microbiol Biotechnol* 44:139, 1995.
- Bruand C, Le Chatelier E, Ehrlich SD, Janniere L. A fourth class of theta-replicating plasmids: the pAM β 1 family from gram-positive bacteria. *Proc Natl Acad Sci USA* 90:11668, 1993.
- Brüssow H, Bruttin A, Desiere F, Lucchini S, Foley S. Molecular ecology and evolution of *Streptococcus thermophilus* bacteriophages—a review. *Virus Genes* 16:95, 1998.
- Buckley ND, Vadeboncoeur C, LeBlanc DJ, Lee LN, Frenette M. An effective strategy, applicable to *Streptococcus salivarius* and related bacteria, to enhance or confer electroporation competence. *Appl Environ Microbiol* 65:3800, 1999.
- Burrus V, Roussel Y, Decaris B, Guédon G. Characterization of a novel integrative element, ICE*St1*, in the lactic acid bacterium *Streptococcus thermophilus*. *Appl Environ Microbiol* 66:1749, 2000.
- Caldwell SL, McMahon DJ, Oberg CJ, Broadbent JR. Induction and characterization of *Pediococcus acidilactici* temperate bacteriophage Syst Appl Microbiol 22:514, 1999.
- Chandry PS, Moore SC, Boyce JD, Davidson BE, Hillier AJ. Analysis of the DNA sequence, gene expression, origin of replication and modular structure of the *Lactococcus lactis* lytic bacteriophage sk1. *Mol Microbiol* 26:49, 1997.
- Chassy BM, Flickinger JL. Transformation of *Lactobacillus casei* by electroporation. *FEMS Microbiol Lett* 44:173, 1987.
- Chopin MC, Chopin A, Rouault A, Simon D. Cloning in *Streptococcus lactis* of plasmid-mediated UV resistance and effect on prophage stability. *Appl Environ Microbiol* 51:233, 1986.
- Chou YC. Development of an electroporation system for transformation and cloning of the maltose utilization genes from *Lactobacillus* sp. DB29. MS thesis, Utah State University, Logan, Utah, 1992.
- Clewell DB. Plasmids, drug resistance, and gene transfer in the genus *Streptococcus*. *Microbiol Rev* 45:409, 1981.
- Climo MW, Sharma VK, Archer GL. Identification and characterization of the origin of conjugative transfer (*oriT*) and a gene (*nes*) encoding a single-stranded endonuclease on the staphylococcal plasmid pGO1. *J Bacteriol* 178:4975, 1996.
- Cocconcelli PS, Morelli L, Vescovo M, Bottazi V. Intergeneric protoplast fusion in lactic acid bacteria. *FEMS Microbiol Lett* 35:211, 1986.
- Collins MD, Rodriguez Jovita M, Lawson PA, Falsen E, Foster G. Characterization of a novel gram-positive, catalase-negative coccus from horses: description of *Eremococcus coleocola* gen. nov., sp. nov. *Int J Syst Bacteriol* 49:1381, 1999.
- Cousineau B, Smith D, Lawrence-Cavanagh S, Mueller JE, Yang J, Mills D, Manias D, Dunny G, Lambowitz AM, Belfort M. Retrohoming of a bacterial group II intron: mobility via complete reverse splicing, independent of homologous DNA recombination. *Cell* 94:451, 1998.
- Curic M, Stuer-Lauridsen B, Renault P, Nilsson D. A general method for selection of

- α -acetolactate decarboxylase-deficient *Lactococcus lactis* mutants to improve diacetyl formation. *Appl Environ Microbiol* 65:1202, 1999.
- Daveran-Mingot ML, Campo N, Ritzenthaler P, Le Bourgeois P. A natural large chromosomal inversion in *Lactococcus lactis* is mediated by homologous recombination between two insertion sequences. *J Bacteriol* 180:4834, 1998.
- David S, Simons G, De Vos WM. Plasmid transformation by electroporation of *Leuconostoc paramesenteroides* and its use in molecular cloning. *Appl Environ Microbiol* 55:1483, 1989.
- Davidson BE, Powell IB, Hillier AJ. Temperate bacteriophages and lysogeny in lactic acid bacteria. *FEMS Microbiol Rev* 87:79, 1990.
- Davidson BE, Kordias N, Baseggio N, Lim A, Dobos M, Hillier AJ. Genomic organization in lactococci. In: Ferretti JJ, Gilmore MS, Klaenhammer TR, Brown F, eds. *Genetics of Streptococci, Enterococci, and Lactococci*. *Dev Biol Stand Vol* 85. Basel: Karger, 1995, p 411.
- Davidson BE, Kordias N, Dobos M, Hillier AJ. Genomic organization in lactic acid bacteria. *Antonie van Leeuwenhoek* 70:161, 1996.
- Davis C, Silveira NF, Fleet GH. Occurrence and properties of bacteriophages of *Leuconostoc oenos* in Australian wines. *Appl Environ Microbiol* 50:872, 1985.
- Del Solar G, Giraldo R, Ruiz-Echevarria MJ, Espinosa M, Diaz-Orejas R. Replication and control of circular bacterial plasmids. *Microbiol Mol Biol Rev* 62:434, 1998.
- De Ruyter PGGA, Kuipers OP, Meyer WC, De Vos WM. Food-grade controlled lysis of *Lactococcus lactis* for accelerated cheese ripening. *Nature Biotechnol* 15:976, 1997.
- Desiere F, Lucchini S, Brüssow H. Comparative sequence analysis of the DNA packaging, head, and tail morphogenesis modules in the temperate cos-site *Streptococcus thermophilus* bacteriophage Sfi21. *Virology* 260:244, 1999.
- De Vos WM. Metabolic engineering of sugar catabolism in lactic acid bacteria. *Antonie van Leeuwenhoek* 70:223, 1996.
- De Vos WM, Simons GFM. Gene cloning and expression systems in lactococci. In: Gasson MJ, De Vos WM, eds. *Genetics and Biotechnology of Lactic Acid Bacteria*. London: Blackie, 1994, p 52.
- De Vos WM, Vaughan EE. Genetics of lactose utilization in lactic acid bacteria. *FEMS Microbiol Rev* 15:217, 1994.
- De Vos WM, Beerthuyzen MM, Luesink EL, Kuipers OP. Genetics of the nisin operon and the nisin-sucrose conjugative transposon Tn5276. In: Ferretti JJ, Gilmore MS, Klaenhammer TR, Brown F, eds. *Genetics of Streptococci, Enterococci, and Lactococci*. *Dev Biol Stand Vol* 85. Basel: Karger, 1995, p 617.
- Díaz E, López R, García JL. EJ-1, a temperate bacteriophage of *Streptococcus pneumoniae* with a *Myoviridae* morphotype. *J Bacteriol* 174:5516, 1992.
- Dinsmore PK, Romero DA, Klaenhammer TR. Insertional mutagenesis in *Lactococcus lactis* subsp. *lactis* mediated by IS946. *FEMS Microbiol Lett* 107:43, 1993.
- Djordjevic GM, O'Sullivan DJ, Walker SA, Conkling MA, Klaenhammer TR. A triggered-suicide system designed as a defense against bacteriophages. *J Bacteriol* 179:6741, 1997.
- Dmitriev A, Suvorov A, Totolian A. Physical and genetic chromosomal maps of *Streptococcus agalactiae*, serotypes II and III; rRNA operon organization. *FEMS Microbiol Lett* 167:33, 1998.

- Dodd HM, Gasson MJ. Bacteriocins of lactic acid bacteria. In: Gasson MJ, De Vos WM, eds. Genetics and Biotechnology of Lactic Acid Bacteria. London: Blackie, 1994, p. 211.
- Dodd HM, Horn N, Gasson MJ. Analysis of the genetic determinant for production of the peptide antibiotic nisin. J Gen Microbiol 136:555, 1990.
- Dodd HM, Horn N, Gasson MJ. Characterization of IS905, a new multicopy insertion sequence identified in lactococci. J Bacteriol 176:3393, 1994.
- Dougherty BA, Hill C, Weidman JF, Richardson DR, Venter JC, Ross RP. Sequence and analysis of the 60 kb conjugative, bacteriocin-producing plasmid pMRC01 from *Lactococcus lactis* DPC3147. Mol Microbiol 29:1029, 1998.
- Duan K, Harvey ML, Liu CQ, Dunn NW. Identification and characterization of a mobilizing plasmid, pND300, in *Lactococcus lactis* M189 and its encoded nisin resistance determinant. Appl Bacteriol 81:493, 1996.
- Dunny GM, Leonard BAB. Cell-cell communication in gram-positive bacteria. Annu Rev Microbiol 51:527, 1997.
- Dunny GM, McKay LL. Group II introns and expression of conjugative transfer functions in lactic acid bacteria. Antonie van Leeuwenhoek 76:77, 1999.
- Dunny GM, Lee LN, LeBlanc DJ. Improved electroporation and cloning vector system for gram-positive bacteria. Appl Environ Microbiol 57:1194, 1991.
- Durmaz E, Klaenhammer TR. Genetic analysis of chromosomal regions of *Lactococcus lactis* acquired by recombinant lytic phages. Appl Environ Microbiol 66:895, 2000.
- Ehrmann MA, Remiger A, Eijssink VG, Vogel RF. A gene cluster encoding plantaricin 1.25 β and other bacteriocin-like peptides in *Lactobacillus plantarum* TMW1.25. Biochim Biophys Acta 1490:355, 2000.
- Firth N, Ippen-Ihler K, Skurray RA. Structure and function of the F factor and mechanism of conjugation. In: Neidhardt FC, Curtiss III R, Ingraham JL, Lin ECC, Low KB, Magasanik B, Reznikoff WS, Riley M, Schaechter M, Umberger HE, eds. *Escherichia coli* and *Salmonella typhimurium*; Cellular and Molecular Biology. Vol 1. 2nd ed. Washington, DC: American Society for Microbiology, 1996, p 1539.
- Fodor K, Alfoldi L. Fusion of protoplasts of *Bacillus magisterium*. Proc Natl Acad Sci 73:2147, 1976.
- Foley S, Lucchini S, Zwahlen MC, Brüssow H. A short noncoding viral DNA element showing characteristics of a replication origin confers bacteriophage resistance to *Streptococcus thermophilus*. Virology 250:377, 1998.
- Foley S, Bruttin A, Brüssow H. Widespread distribution of a group I intron and its three deletion derivatives in the lysin gene of *Streptococcus thermophilus* bacteriophages. Virology 74:611, 2000.
- Frangoul L, Nelson KE, Buchrieser C, Danchin A, Glaser P, Kunst F. Cloning and assembly strategies in microbial genome projects. Microbiology 145:2625, 1999.
- Froseth BR, Herman RE, McKay LL. Cloning of nisin resistance determinant and replication origin on 7.6-kilobase *EcoRI* fragment of pNP40 from *Streptococcus lactis* subsp. *diacetylactis* DRC3. Appl Environ Microbiol 54:2136, 1988.
- Garbutt KC, Kraus J, Geller BL. Bacteriophage resistance in *Lactococcus lactis* engineered by replacement of a gene for a bacteriophage receptor. J Dairy Sci 80:1512, 1997.
- García P, Martín AC, Lopez R. Bacteriophages of *Streptococcus pneumoniae*: a molecular approach. Microb Drug Resist 3:165, 1997.

- Garvey P, Van Sinderen D, Twomey DP, Hill C, Fitzgerald GF. Molecular genetics of bacteriophage and natural phage defense systems in the genus *Lactococcus*. *Int Dairy J* 5:905, 1995.
- Gasc AM, Kauc L, Barraille P, Sicard M, Goodgal S. Gene localization, size, and physical map of the chromosome of *Streptococcus pneumoniae*. *J Bacteriol* 173:7361, 1991.
- Gasson MJ. Production, regeneration, and fusion of protoplasts in lactic streptococci. *FEMS Microbiol Lett* 9:99, 1980.
- Gasson MJ, De Vos WM, eds. *Genetics and Biotechnology of Lactic Acid Bacteria*. London: Blackie, 1994.
- Gasson MJ, Fitzgerald GF. Gene transfer systems and transposition. In: Gasson MJ, De Vos WM, eds. *Genetics and Biotechnology of Lactic Acid Bacteria*. London: Blackie, 1994, p 1.
- Gasson MJ, Godon J-J, Pillidge CJ, Eaton TJ, Jury K, Shearman CA. Characterization and exploitation of conjugation in *Lactococcus lactis*. *Int Dairy J* 5:757, 1995.
- Geller BL, Ivey RG, Trempy JE, Hettlinger-Smith B. Cloning of a chromosomal gene required for phage infection of *Lactococcus lactis* subsp. *lactis* C2. *J Bacteriol* 175: 5510, 1993.
- Germond JE, Lapiere L, Delley M, Mollet B. A new mobile genetic element in *Lactobacillus delbrueckii* subsp. *bulgaricus*. *Mol Gen Genet* 248:407, 1995.
- Godon JJ, Jury K, Shearman CA, Gasson MJ. The *Lactococcus lactis* sex-factor aggregation gene *cluA*. *Mol Microbiol* 12:655, 1994.
- Gonzales CF, Kunka BS. Transfer of sucrose-fermenting ability and nisin production phenotype among lactic streptococci. *Appl Environ Microbiol* 49:627, 1985.
- Goupil-Feuillerat N, Cocaign-Bousquet M, Godon J-J, Ehrlich SD, Renault P. Dual role of α -acetolactate decarboxylase in *Lactococcus lactis* subsp. *lactis*. *J Bacteriol* 179: 6285, 1997.
- Gravesen A, Josephsen J, von Wright A, Vogensen FK. Characterization of the replicon from the lactococcal theta-replicating plasmid pJW563. *Plasmid* 34:105, 1995.
- Gravesen A, von Wright A, Josephsen J, Vogensen FK. Replication regions of two pairs of incompatible lactococcal theta-replicating plasmids. *Plasmid* 38:115, 1997.
- Grohmann E, Moscoso M, Zechner EL, Del Solar G, Espinosa M. *In vivo* definition of the functional origin of leading strand replication on the lactococcal plasmid pFX2. *Mol Gen Genet* 260:38, 1998.
- Grohmann E, Guzmán LM, Espinosa M. Mobilisation of the streptococcal plasmid pMV158: interactions of MobM protein with its cognate *oriT*DNA region. *Mol Gen Genet* 261:707, 1999.
- Gruss A, Ehrlich SD. The family of highly interrelated single-stranded deoxyribonucleic acid plasmids. *Microbiol Rev* 53:231, 1989.
- Guédon G, Bourgoïn F, Pebay M, Roussel Y, Colmin C, Simonet JM, Decaris B. Characterization and distribution of two insertion sequences, *IS1191* and *iso-IS981*, in *Streptococcus thermophilus*: does intergeneric transfer of insertion sequences occur in lactic acid bacteria co-cultures? *Mol Microbiol* 16:69, 1995.
- Guzmán LM, Espinosa M. The mobilization protein, MobM, of the streptococcal plasmid pMV158 specifically cleaves supercoiled DNA at the plasmid *oriT*. *J Mol Biol* 266: 688, 1997.

- Hantman MJ, Sun S, Piggot PJ, Daneo-Moore L. Chromosome organization of *Streptococcus mutans* GS-5. *J Gen Microbiol* 139:67, 1993.
- Haren L, Ton-Hoang B, Chandler M. Integrating DNA: transposases and retroviral integrases. *Annu Rev Microbiol* 53:245, 1999.
- Harlander SK. Transformation of *Streptococcus lactis* by electroporation. In: Ferretti JJ, Curtiss III R, eds. *Streptococcal Genetics*. Washington, DC: American Society for Microbiology, 1987, p 229.
- Hashiba H, Takiguchi R, Ishii S, Aoyama K. Transformation of *Lactobacillus helveticus* subsp. *jugurti* with plasmid pLHR by electroporation. *Agric Biol Chem* 54:1537, 1990.
- Hashiba H, Takiguchi R, Jyoho K, Aoyama K. Establishment of a host-vector system in *Lactobacillus helveticus* with β -galactosidase activity as a selection marker. *Biosci Biotechnol Biochem* 56:190, 1992.
- Havarstein LS, Hakenbeck R, Gaustad P. Natural competence in the genus *Streptococcus*: evidence that streptococci can exchange pherotypes by interspecies recombinational exchanges. *J Bacteriol* 179:6589, 1997.
- Herbin S, Mathieu F, Brule F, Branlant C, Lefebvre G, Lebrühi A. Characteristics and genetic determinants of bacteriocin activities produced by *Carnobacterium piscicola* CP5 isolated from cheese. *Curr Microbiol* 35:319, 1997.
- Hill C. Bacteriophage and bacteriophage resistance in lactic acid bacteria. *FEMS Microbiol Rev* 12:87, 1993.
- Hill C, Miller LA, Klaenhammer TR. Cloning, expression, and sequence determination of a bacteriophage fragment encoding bacteriophage resistance in *Lactococcus lactis*. *J Bacteriol* 172:6419, 1990.
- Ho SY, Mittal GS. Electroporation of cell membranes: A review. *Crit Rev Biotechnol* 16:349, 1996.
- Holo H, Nes IF. High-frequency transformation, by electroporation, of *Lactococcus lactis* ssp. *cremoris* grown with glycine in osmotically stabilized media. *Appl Environ Microbiol* 55:3119, 1989.
- Horaud T, De Cespedes G, Trieu-Cuot P. Chromosomal gentamicin resistance transposon Tn3706 in *Streptococcus agalactiae* B128. *Antimicrob Agents Chemother* 40:1085, 1996.
- Horn N, Swindell S, Dodd H, Gasson M. Nisin biosynthesis genes are encoded by a novel conjugative transposon. *Mol Gen Genet* 228:129, 1991.
- Huang DC, Novel M, Huang XF, Novel G. Nonidentity between plasmid and chromosomal copies of ISS1-like sequences in *Lactococcus lactis* subsp. *lactis* CNRZ270 and their possible role in chromosomal integration of plasmid genes. *Gene* 118:39, 1992.
- Huang DC, Huang XF, Novel G, Novel M. Two genes present on a transposon-like structure in *Lactococcus lactis* are involved in a Clp-family proteolytic activity. *Mol Microbiol* 7:957, 1993.
- International Dairy Federation (IDF). *Cheese Facts*. Washington, DC: National Cheese Institute, 1994.
- International Dairy Federation (IDF). *Bulletin 339: The world dairy situation 1999*. Brussels: International Dairy Federation, 1999.
- Israelsen H, Madsen SM, Vrang A, Hansen EB, Johansen E. Cloning and partial character-

- ization of regulated promoters from *Lactococcus lactis* Tn917-*lacZ* integrants with the new promoter probe vector, pAK80. Appl Environ Microbiol 61:2540, 1995.
- Itaya M, Tanaka T. Experimental surgery to create subgenomes of *Bacillus subtilis* 168. Proc Natl Acad Sci USA 94:5378, 1997.
- Iwata M, Mada M, Ishiwa H. Protoplast fusion of *Lactobacillus fermentum*. Appl Environ Microbiol 52:392, 1986.
- Jarvis AW, Jarvis BDW. Deoxyribonucleic acid homology among lactic streptococci. Appl Environ Microbiol 41:77, 1981.
- Jarvis AW, Fitzgerald GF, Mata M, Mercenier A, Neve H, Powell IB, Ronda C, Saxelin M, Teuber M. Species and type phages of lactococcal bacteriophages. Intervirology 32:2, 1991.
- Jarvis AW, Collins LJ, Ackermann HW. A study of five bacteriophages of the *Myoviridae* family which replicate on different gram-positive bacteria. Arch Virol 133:75, 1993.
- Jaworski DD, Clewell DB. A functional origin of transfer (*oriT*) on the conjugative transposon Tn916. J Bacteriol 177:6644, 1995.
- Jensen GB, Andrup L, Wilcks A, Smidt L, Poulsen OM. The aggregation-mediated conjugation system of *Bacillus thuringiensis* subsp. *israelensis*: host range and kinetics of transfer. Curr Microbiol 33:228, 1996.
- Johansen E, Kibenich A. Isolation and characterization of IS1165, an insertion sequence of *Leuconostoc mesenteroides* subsp. *cremoris* and other lactic acid bacteria. Plasmid 27:200, 1992.
- Josson K, Soetaert P, Michiels F, Joos H, Mahillon J. *Lactobacillus hilgardii* plasmid pLAB1000 consists of two functional cassettes commonly found in other gram-positive organisms. J Bacteriol 172:3089, 1990.
- Kahala M, Palva A. The expression signals of the *Lactobacillus brevis* *slpA* gene direct efficient heterologous protein production in lactic acid bacteria. Appl Microbiol Biotechnol 51:71, 1999.
- Kao KN, Michayluk MR. A method for high-frequency intergeneric fusion of plant protoplasts. Planta 115:355, 1974.
- Kanatani K, Yoshida K, Tahara T, Sakamoto M, Oshimura M. Intraspecific protoplast fusion of *Lactobacillus plantarum*. Agric Biol Chem 54:225, 1990.
- Kanatani K, Oshimura M, Sano K. Isolation and characterization of acidocin A and cloning of the bacteriocin gene from *Lactobacillus acidophilus*. Appl Environ Microbiol 61:1061, 1995.
- Kantor A, Montville TJ, Mett A, Shapira R. Molecular characterization of the replicon of the *Pediococcus pentosaceus* 43200 pediocin A plasmid pMD136. FEMS Microbiol Lett 151:237, 1997.
- Kearney K, Fitzgerald GF, Seegers JF. Identification and characterization of an active plasmid partition mechanism for the novel *Lactococcus lactis* plasmid pCI2000. J Bacteriol 182:30, 2000.
- Khan SA. Rolling-circle replication of bacterial plasmids. Microbiol Mol Biol Rev 61:442, 1997.
- Khunajakr N, Liu CQ, Charoenchai P, Dunn NW. A plasmid-encoded two-component regulatory system involved in copper-inducible transcription in *Lactococcus lactis*. Gene 229:229, 1999.
- Kiewiet R, Kok J, Seegers JFML, Venema G, Bron S. The mode of replication is a major

- factor in segregational plasmid instability in *Lactococcus lactis*. Appl Environ Microbiol 59:358, 1993.
- Kim SG, Batt CA. Antisense mRNA-mediated bacteriophage resistance in *Lactococcus lactis* subsp. *lactis*. Appl Environ Microbiol 57:1109, 1991.
- Klaenhammer TR, Fitzgerald GF. Bacteriophages and bacteriophage resistance. In: Gasson MJ, De Vos WM, eds. Genetics and Biotechnology of Lactic Acid Bacteria. London: Blackie, 1994, p 106.
- Kodaira KI, Oki M, Kakikawa M, Watanabe N, Hirakawa M, Yamada K, Taketo A. Genome structure of the *Lactobacillus* temperate phage ϕ gle: the whole genome sequence and the putative promoter/repressor system. Gene 187:45, 1997.
- Kok J. Inducible gene expression and environmentally regulated genes in lactic acid bacteria. Antonie van Leeuwenhoek 70:129, 1996.
- Kondo JK, McKay LL. Gene transfer systems and molecular cloning in group N streptococci: a review. J Dairy Sci 68:2143, 1985.
- Lahib-Mansais Y, Mata M, Ritzenthaler P. Molecular taxonomy of *Lactobacillus* phages. Biochimie 70:429, 1988.
- Lambowitz AM, Belfort M. Introns as mobile genetic elements. Annu Rev Biochem 62: 587, 1993.
- Langela P, Le Loir Y, Ehrlich SD, Gruss A. Efficient plasmid mobilization by pIP501 in *Lactococcus lactis* subsp. *lactis*. J Bacteriol 175:5806, 1993.
- Lanka E, Wilkins BM. DNA processing reactions in bacterial conjugation. Annu Rev Biochem 64:141, 1995.
- Leblond P, Decaris B. Chromosome geometry and intraspecific genetic polymorphism in gram-positive bacteria revealed by pulsed-field gel electrophoresis. Electrophoresis 19:582, 1998.
- Le Bourgeois P, Lautier M, Mata M, Ritzenthaler P. Physical and genetic map of the chromosome of *Lactococcus lactis* subsp. *lactis* IL1403. J Bacteriol 174:6752, 1992a.
- Le Bourgeois P, Lautier M, Mata M, Ritzenthaler P. New tools for the physical and genetic mapping of *Lactococcus* strains. Gene 111:109, 1992b.
- Le Bourgeois P, Lautier M, Ritzenthaler P. Chromosome mapping in lactic acid bacteria. FEMS Microbiol Rev 12:109, 1993.
- Lee PC, Park IY, Kim MS, Kim SC. Effect of the replication mode of a plasmid on the stability of multimeric endoxylanase genes in *Bacillus subtilis*. J Biotechnol 62: 177, 1998.
- Leenhouts K. Development and use of plasmid integration systems for lactococci. Ph.D. dissertation, University of Groningen, Groningen, The Netherlands, 1990.
- Leenhouts K, Bolhuis A, Venema G, Kok J. Construction of a food-grade multiple-copy integration system for *Lactococcus lactis*. Appl Microbiol Biotechnol 49:417, 1998.
- Le Marrec C, Van Sinderen D, Walsh L, Stanley E, Vlegels E, Moineau S, Heinze P, Fitzgerald G, Fayard B. Two groups of bacteriophages infecting *Streptococcus thermophilus* can be distinguished on the basis of mode of packaging and genetic determinants for major structural proteins. Appl Environ Microbiol 63:3246, 1997.
- Lin MY, Harlander S, Savaiano D. Construction of an integrative food-grade cloning vector for *Lactobacillus acidophilus*. Appl Microbiol Biotechnol 45:484, 1996.

- Liu CQ, Leelawatcharamas V, Harvey ML, Dunn NW. Cloning vectors for lactococci based on a plasmid encoding resistance to cadmium. *Curr Microbiol* 33:35, 1996.
- Low D, Ahlgren J, Horne D, McMahon DJ, Oberg CJ, Broadbent JR. Role of *Streptococcus thermophilus* MR-1C capsular exopolysaccharide in cheese moisture retention. *Appl Environ Microbiol* 64:2147, 1998.
- Lucchini S, Desiere F, Brüßow H. The genetic relationship between virulent and temperate *Streptococcus thermophilus* bacteriophages: whole genome comparison of *cos*-site phages Sfi19 and Sfi21. *Virology* 260:232, 1999a.
- Lucchini S, Desiere F, Brüßow H. Similarly organized lysogeny modules in temperate *Siphoviridae* from low GC content gram-positive bacteria. *Virology* 263:427, 1999b.
- Lucchini S, Desiere F, Brüßow H. Comparative genomics of *Streptococcus thermophilus* phage species supports a modular evolution theory. *J Virology* 73:8647, 1999c.
- Luchansky JB, Muriana PM, Klaenhammer TR. Application of electroporation for transfer of plasmid DNA to *Lactobacillus*, *Lactococcus*, *Leuconostoc*, *Listeria*, *Pediococcus*, *Bacillus*, *Staphylococcus*, *Enterococcus* and *Propionibacterium*. *Mol Microbiol* 2:637, 1988.
- Lurquin PF. Gene transfer by electroporation. *Mol Biotechnol* 7:5, 1997.
- Magni C, de Felipe FL, Lopez P, de Mendoza D. Characterization of an insertion sequence-like element identified in plasmid pCIT264 from *Lactococcus lactis* subsp. *lactis* biovar. *diacetylactis*. *FEMS Microbiol Lett* 136:289, 1996.
- Maguin E, Duwat P, Hege T, Ehrlich SD, Gruss A. New thermosensitive plasmid for gram-positive bacteria. *J Bacteriol* 174:5633, 1992.
- Maguin E, Prevost H, Ehrlich SD, Gruss A. Efficient insertional mutagenesis in lactococci and other gram-positive bacteria. *J Bacteriol* 178:931, 1996.
- Mahillon J, Chandler M. Insertion sequences. *Microbiol Mol Biol Rev* 62:725, 1998.
- Manchester LN. Characterization of a bacteriophage for *Carnobacterium divergens* NCFB 2763 by host specificity and electron microscopy. *Lett Appl Microbiol* 25:401, 1997.
- Marciset O, Mollet B. Multifactorial experimental designs for optimizing transformation: electroporation of *Streptococcus thermophilus*. *Biotechnol Bioeng* 43:490, 1994.
- Martin M, Corrales MA, de Mendoza D, Lopez P, Magni C. Cloning and molecular characterization of the citrate utilization *citMCDEFGRP* cluster of *Leuconostoc paramesenteroides*. *FEMS Microbiol Lett* 174:231, 1999.
- Mayo B, Gonzalez B, Arca P, Suarez JE. Cloning and expression of the plasmid encoded β -D-galactosidase gene from a *Lactobacillus plantarum* strain of dairy origin. *FEMS Microbiol Lett* 122:145, 1994.
- McAshan SK, Vergin KL, Giovannoni SJ, Thaler DS. Interspecies recombination between enterococci: genetic and phenotypic diversity of vancomycin-resistant transconjugants. *Microb Drug Resist* 5:101, 1999.
- McGrath S, Seegers JFML, Fitzgerald GF, Van Sinderen D. Molecular characterization of a phage-encoded resistance system in *Lactococcus lactis*. *Appl Environ Microbiol* 65:1891, 1999.
- McKay LL. Functional properties of plasmids in lactic streptococci. *Antonie van Leeuwenhoek* 49:259, 1983.
- McKay LL, Baldwin KA. Simultaneous loss of proteinase- and lactose-utilizing enzyme

- activities in *Streptococcus lactis* and reversal of loss by transduction. *Appl Environ Microbiol* 28:342, 1974.
- McKay LL, Baldwin KA. Stabilization of lactose metabolism in *Streptococcus lactis* C2. *Appl Environ Microbiol* 36:360, 1978.
- McKay LL, Baldwin KA, Efstathiou JD. Transductional evidence for plasmid linkage of lactose metabolism in *Streptococcus lactis* C2. *Appl Environ Microbiol* 32:45, 1976.
- McShan WM, Ferretti JJ. Genetic studies of erythrotoxic toxin carrying temperate bacteriophages of *Streptococcus pyogenes*. In: Horaud T, ed. *Streptococci and the Host*. New York: Plenum Press, 1997, p 971.
- Meijer WJ, de Boer AJ, van Tongeren S, Venema G, Bron S. Characterization of the replication region of the *Bacillus subtilis* plasmid pLS20: a novel type of replicon. *Nucleic Acids Res* 23:3214, 1995.
- Meinhardt F, Schaffrath R, Larsen M. Microbial linear plasmids. *Appl Microbiol Biotechnol* 47:329, 1997.
- Mercenier A, Slos P, Faelen M, Lecocq JP. Plasmid transduction in *Streptococcus thermophilus*. *Mol Gen Genet* 212:386, 1988.
- Mikkonen M, Alattosava T. A group I intron in the terminase gene of *Lactobacillus delbrueckii* subsp. *lactis* phage LL-H. *Microbiol* 141:2183, 1995.
- Mikkonen M, Raisanen L, Alattosava T. The early gene region completes the nucleotide sequence of *Lactobacillus delbrueckii* subsp. *lactis* phage LL-H. *Gene* 175:49, 1996.
- Mills DA, McKay LL, Dunny GM. Splicing of a group II intron involved in the conjugative transfer of pRS01 in lactococci. *J Bacteriol* 178:3531, 1996.
- Mills DA, Manias DA, McKay LL, Dunny G. Homing of a group II intron from *Lactococcus lactis* subsp. *lactis* ML3. *J Bacteriol* 179:6107, 1997.
- Mills DA, Phister TG, Dunny GM, McKay LL. An origin of transfer (*oriT*) on the conjugative element pRS01 from *Lactococcus lactis* subsp. *lactis* ML3. *Appl Environ Microbiol* 64:1541, 1998.
- Mizuuchi K. Transpositional recombination: mechanistic insights from studies of Mu and other elements. *Annu Rev Biochem* 61:1011, 1992.
- Moineau S, Pandian S, Klaenhammer TR. Evolution of a lytic bacteriophage via DNA acquisition from the *Lactococcus lactis* chromosome. *Appl Environ Microbiol* 60:1832, 1994.
- Morea M, Baruzzi F, Coconcelli PS. Molecular and physiological characterization of dominant bacterial populations in traditional mozzarella cheese processing. *Appl Microbiol* 87:574, 1999.
- Nardi M, Renault P, Monnet V. Duplication of the *pepF* gene and shuffling of DNA fragments on the lactose plasmid of *Lactococcus lactis*. *J Bacteriol* 179:4164, 1997.
- Nauta A, Van den Burg B, Karsens H, Venema G, Kok J. Design of thermolabile bacteriophage repressor mutants by comparative molecular modeling. *Nat Biotechnol* 15:980, 1997.
- Okamoto T, Fujita Y, Irie R. Fusion of protoplasts of *Streptococcus lactis*. *Agric Biol Chem* 47:2675, 1983.
- O'Sullivan DJ, Walker SA, West SG, Klaenhammer TR. Development of an expression

- strategy using a lytic phage to trigger explosive plasmid amplification and gene expression. *Biotechnology (NY)* 14:82, 1996.
- Park KH, Kato H, Nakai T, Muroga K. Phage typing of *Lactococcus garvieae* (formerly *Enterococcus seriolicida*) a pathogen of cultured yellowtail. *Fisheries Sci* 64:62, 1998.
- Polzin KM, McKay LL. Identification, DNA sequence, and distribution of IS981, a new, high-copy-number insertion sequence in lactococci. *Appl Environ Microbiol* 57:734, 1991.
- Polzin KM, McKay LL. Development of a lactococcal integration vector by using IS981 and a temperature-sensitive lactococcal replication region. *Appl Environ Microbiol* 58:476, 1992.
- Polzin KM, Shimizu-Kadota M. Identification of a new insertion element similar to gram-negative IS26, on the lactose plasmid of *Streptococcus lactis* ML3. *J Bacteriol* 169:5481, 1987.
- Polzin KM, Romero D, Shimizu-Kadota M, Klaenhammer TR, McKay LL. Copy number and location of insertion sequences ISS1 and IS981 in lactococci and several other lactic acid bacteria. *J Dairy Sci* 76:1243, 1993.
- Posno M, Leer RJ, Van Lwijk N, Van Giezen MJF, Heuvelmans PTHM, Lokman BC, Pouwels PH. Incompatibility of *Lactobacillus* vectors with replicons derived from small cryptic *Lactobacillus* plasmids and segregational instability of the introduced vectors. *Appl Environ Microbiol* 57:1822, 1991.
- Powell IB, Achen MG, Hillier A, Davidson BE. A simple and rapid method for genetic transformation of lactic streptococci by electroporation. *Appl Environ Microbiol* 54:655, 1988.
- Prevots F, Mata M, Ritzenthaler P. Taxonomic differentiation of 101 lactococcal bacteriophages and characterization of bacteriophages with unusually large genomes. *Appl Environ Microbiol*. 56:2180, 1990.
- Pridmore D, Stefanova T, Mollet B. Cryptic plasmids from *Lactobacillus helveticus* and their evolutionary relationship. *FEMS Microbiol Lett* 124:301, 1994.
- Rauch PJG, Beerthuyzen MM, De Vos WM. Distribution and evolution of nisin-sucrose elements in *Lactococcus lactis*. *Appl Environ Microbiol* 60:1798, 1994.
- Ravn P, Arnau J, Madsen SM, Vrang A, Israelsen H. The development of TnNuc and its use for the isolation of novel secretion signals in *Lactococcus lactis*. *Gene* 242:347, 2000.
- Ray B. *Pediococcus* in fermented foods. In: Hui YH, Khachatourians GG, eds. *Food Biotechnology: Microorganisms*. New York: VCH, 1995, p. 745.
- Raya RR, Kleeman EG, Luchansky JB, Klaenhammer TR. Characterization of the temperate bacteriophage Øadh and plasmid transduction in *Lactobacillus acidophilus* ADH. *Appl Environ Microbiol* 55:2206, 1989.
- Reniero R, Cocconcelli P, Bottazzi V. High frequency of conjugation in *Lactobacillus* mediated by an aggregation-promoting factor. *J Gen Microbiol* 138:763, 1992.
- Romero DA, Klaenhammer TR. Characterization of insertion sequence IS946, an Iso-ISS1 element, isolated from the conjugative lactococcal plasmid pTRK2030. *J Bacteriol* 172:4151, 1990.
- Romero DA, Klaenhammer TR. Construction of an IS946-based composite transposon in *Lactococcus lactis* subsp. *lactis*. *J Bacteriol* 173:7599, 1991.

- Romero DA, Slos P, Castellina RL, Castellina I, Mercenier A. Conjugative mobilization as an alternate vector delivery system for lactic streptococci. *Appl Environ Microbiol* 53:2405, 1987.
- Roussel Y, Pebay M, Guédon G, Simonet JM, Decaris B. Physical and genetic map of *Streptococcus thermophilus* A054. *J Bacteriol* 176:7413, 1994.
- Roussel Y, Bourgoïn F, Guédon G, Pebay M, Decaris B. Analysis of the genetic polymorphism between three *Streptococcus thermophilus* strains by comparing their physical and genetic organization. *Microbiol* 143:1335, 1997.
- Salminen S, von Wright A, eds. *Lactic Acid Bacteria: Microbiology and Functional Aspects*. 2nd ed. New York: Marcel Dekker, 1998.
- Salyers AA, Shoemaker NB. Conjugative transposons. *Genet Eng (NY)* 19:89, 1997.
- Salyers AA, Shoemaker NB, Stevens AM, Li LY. Conjugative transposons: an unusual and diverse set of integrated gene transfer elements. *Microbiol Rev* 59:579, 1995.
- Sanders ME, Leonhard PJ, Sing WD, Klaenhammer TR. Conjugal strategy for construction of fast acid-producing, bacteriophage resistant lactic streptococci for use in dairy fermentations. *Appl Environ Microbiol* 52:1001, 1986.
- Sandine WE, Elliker PR, Allen LK, Brown WC. II. Genetic exchange and variability in lactic *Streptococcus* starter organisms. *J Dairy Sci* 45:1266, 1962.
- Savijoki K, Kahala M, Palva A. High level heterologous protein production in *Lactococcus* and *Lactobacillus* using a new secretion system based on the *Lactobacillus brevis* S-layer signals. *Gene* 186:255, 1997.
- Schaeffer P, Cami B, and Hotchkiss RD. Fusion of bacterial protoplasts. *Proc Natl Acad Sci USA* 73:2151, 1976.
- Schmitt C, Guedon G, Bourgoïn F, Decaris B. *Streptococcus thermophilus* insertion sequence IS1193 transposase gene. GenBank accession number Y13713, 1998.
- Schved F, Lalazar A, Henis Y, Juven BJ. Purification, partial characterization and plasmid-linkage of pediocin SJ-1, a bacteriocin produced by *Pediococcus acidilactici*. *J Appl Bacteriol* 74:67, 1993.
- Séchaud L, Cluzel J-P, Rousseau M, Baumgartner A, Accolas J-P. Bacteriophages of lactobacilli. *Biochimie* 70:401, 1988.
- Seegers JF, Bron S, Franke CM, Venema G, Kiewiet R. The majority of lactococcal plasmids carry a highly related replicon. *Microbiology* 140:1291, 1994.
- Shearman C, Godon JJ, Gasson M. Splicing of a group II intron in a functional transfer gene of *Lactococcus lactis*. *Mol Microbiol* 21:45, 1996.
- Shimizu-Kadota M, Sakurai T. Prophage curing in *Lactobacillus casei* by isolation of a thermoinducible mutant. *Appl Environ Microbiol* 43:1284, 1982.
- Shimizu-Kadota M, Sakurai T, Tsuchida N. Prophage origin of a virulent phage appearing on fermentations of *Lactobacillus casei* S-1. *Appl Environ Microbiol* 45:669, 1983.
- Shimizu-Kadota M, Kiwaki M, Hirokawa H, Tsuchida N. ISL1: a new transposable element in *Lactobacillus casei*. *Mol Gen Genet* 200:193, 1985.
- Shimizu-Kadota M, Flickinger JL, Chassy BM. Evidence that *Lactobacillus casei* insertion element ISL1 has a narrow host range. *J Bacteriol* 170:4976, 1988.
- Sing WD, Klaenhammer TR. A strategy for rotation of different bacteriophage defenses in a lactococcal single-strain starter culture system. *Appl Environ Microbiol* 59:365, 1993.
- Skaugen M, Nes IF. Transposition in *Lactobacillus sake* and its abolition of lactocin S

- production by insertion of IS1163, a new member of the IS3 family. *Appl Environ Microbiol* 60:2818, 1994.
- Smith MD. Transformation and fusion of *Streptococcus faecalis* protoplasts. *J Bacteriol* 162:92, 1985.
- Smith MD, Clewell DB. Return of *Streptococcus faecalis* DNA cloned in *Escherichia coli* to its original host via transformation of *Streptococcus sanguis* followed by conjugative mobilization. *J Bacteriol* 160:1109, 1984.
- Snyder L, Champness W. *Molecular Genetics of Bacteria*. Washington, DC: ASM Press, 1997.
- Somkuti GA, Steinberg DH. Genetic transformation of *Streptococcus thermophilus* by electroporation. *Biochimie* 70:579, 1988.
- Somkuti GA, Solaiman DK, Steinberg DH. Structural and functional properties of the *hsp16.4*-bearing plasmid pER341 in *Streptococcus thermophilus*. *Plasmid* 40:61, 1998.
- Sørensen KI, Larsen R, Kibenich A, Junge MP, Johansen E. A food-grade cloning system for industrial strains of *Lactococcus lactis*. *Appl Environ Microbiol* 66:1253, 2000.
- Steele JL, McKay LL. Conjugal transfer of genetic material in lactococci: a review. *J Dairy Sci* 72:3388, 1989.
- Stoianova LG, Polin AN, Egorov NS. Use of the method of protoplast fusion in the selection of a nisin producer. *Antibiot Khimioter* 33:203, 1988.
- Suvorov AN, Ferretti JJ. Physical and genetic chromosomal map of an M type 1 strain of *Streptococcus pyogenes*. *J Bacteriol* 178:5546, 1996.
- Swindell SR, Benson KH, Griffin HG, Renault P, Ehrlich SD, Gasson MJ. Genetic manipulation of the pathway for diacetyl metabolism in *Lactococcus lactis*. *Appl Environ Microbiol* 62:2641, 1996.
- Tailliez P, Ehrlich SD, Chopin MC. Characterization of IS1201, an insertion sequence isolated from *Lactobacillus helveticus*. *Gene* 145:75, 1994.
- Tanaka T, Ogura M. A novel *Bacillus natto* plasmid pLS32 capable of replication in *Bacillus subtilis*. *FEBS Lett* 422:243, 1998.
- Teuber M, Meile L, Schwartz F. Acquired antibiotic resistance in lactic acid bacteria from food. *Antonie van Leeuwenhoek* 76:115, 1999.
- Thompson J, Nguyen NY, Sackett DL, Donkersloot JA. Transposon-encoded sucrose metabolism in *Lactococcus lactis*: purification of sucrose-6-phosphate hydrolase and genetic linkage to N⁵-(L-1-carboxyethyl)ornithine synthase in strain K1. *J Biol Chem* 266:14573, 1991.
- Thompson JK, McConville KJ, McReynolds C, Collins MA. Potential of conjugal transfer as a strategy for the introduction of recombinant genetic material into strains of *Lactobacillus helveticus*. *Appl Environ Microbiol* 65:1910, 1999.
- Tichaczek PS, Vogel RF, Hammes WP. Cloning and sequencing of *curA* encoding curvacin A, the bacteriocin produced by *Lactobacillus curvatus* LTH1174. *Arch Microbiol* 160:279, 1993.
- Tomita H, Clewell DB. A pAD1-encoded small RNA molecule, mD, negatively regulates *Enterococcus faecalis* pheromone response by enhancing transcription termination. *J Bacteriol* 182:1062, 2000.
- Toyama K, Sakurai T, Ari H. Transduction by temperate phage PLS-1 in *Lactobacillus salivarius*. *Nippon Saikingaku Zasshi* 26:482, 1971.

- Tremblay DM, Moineau S. Complete genomic sequence of the lytic bacteriophage DT1 of *Streptococcus thermophilus*. *Virology* 255:63, 1999.
- Trevors KE, Holley RA, Kempton AG. Isolation and characterization of a *Lactobacillus plantarum* bacteriophage isolated from a meat starter culture. *J Appl Bacteriol* 54: 281, 1983.
- Trieu-Cuot P, Carlier C, Martin P, Courvalin P. Plasmid transfer by conjugation from *Escherichia coli* to gram-positive bacteria. *FEMS Microbiol Lett* 48:289, 1987.
- Trieu-Cuot P, Carlier C, Courvalin P. Conjugative plasmid transfer from *Enterococcus faecalis* to *Escherichia coli*. *J Bacteriol* 170:4388, 1988.
- Tulloch DL, Finch LR, Hillier AJ, Davidson BE. Physical map of the chromosome of *Lactococcus lactis* subsp. *lactis* DL11 and localization of six putative rRNA operons. *J Bacteriol* 173:2768, 1991.
- Vandamme P, Pot B, Gillis M, De Vos P, Kersters K, Swings J. Polyphasic taxonomy, a consensus approach to bacterial systematics. *Microbiol Rev* 60:407, 1996.
- Van de Guchte M, Daly C, Fitzgerald GF, Arendt EK. Identification of *int* and *attP* on the genome of bacteriophage Tuc2009 and their use for site-specific plasmid integration in the chromosome of Tuc2009-resistant *Lactococcus lactis* MG1363. *Appl Environ Microbiol* 60:2324, 1994.
- Van der Lelie D, Van der Vossen JMBM, Venema G. Effect of plasmid incompatibility on DNA transfer to *Streptococcus cremoris*. *Appl Environ Microbiol* 54:865, 1988.
- Van der Lelie D, Chavari F, Venema G, Gasson MJ. Identification of a new genetic determinant for cell aggregation associated with lactose plasmid transfer in *Lactococcus lactis*. *Appl Environ Microbiol* 57:201, 1991.
- Van Kranenburg R, De Vos WM. Characterization of multiple regions involved in replication and mobilization of plasmid pNZ4000 coding for exopolysaccharide production in *Lactococcus lactis*. *J Bacteriol* 180:5285, 1998.
- Van Kranenburg R, Marugg JD, Van Swam II, Willem NJ, De Vos WM. Molecular characterization of the plasmid-encoded *eps* gene cluster essential for exopolysaccharide biosynthesis in *Lactococcus lactis*. *Mol Microbiol* 24:387, 1997.
- Van Reenen CA, Dicks LM, Chikindas ML. Isolation, purification and partial characterization of plantaricin 423, a bacteriocin produced by *Lactobacillus plantarum*. *J Appl Microbiol* 84:1131, 1998.
- Van Sinderen D, Karsens H, Kok J, Terpstra P, Ruiters MH, Venema G, Nauta A. Sequence analysis and molecular characterization of the temperate lactococcal bacteriophage r1t. *Mol Microbiol* 19:1343, 1996.
- Vaughan EE, De Vos WM. Identification and characterization of the insertion element *IS1070* from *Leuconostoc lactis* NZ6009. *Gene* 155:95, 1995.
- Vaughan EE, David S, Harrington A, Daly C, Fitzgerald GF, De Vos WM. Characterization of plasmid-encoded citrate permease (*citP*) genes from *Leuconostoc* species reveals high sequence conservation with the *Lactococcus lactis citP* gene. *Appl Environ Microbiol* 61:3172, 1995.
- Venema G, Kok J, Van Sinderen D. From DNA sequence to application: possibilities and complications. *Antonie van Leeuwenhoek* 76:3, 1999.
- von Wright A, Sibakov M. Genetic modification of lactic acid bacteria. In: Salminen S, von Wright A, eds. *Lactic Acid Bacteria: Microbiology and Functional Aspects*. 2nd ed. New York: Marcel Dekker, 1998, p 161.

- Walker SA, Klaenhammer TR. An explosive antisense RNA strategy for inhibition of a lactococcal bacteriophage. *Appl Environ Microbiol* 66:310, 2000.
- Walker DC, Klaenhammer TR. Isolation of a novel IS3 group insertion element and construction of an integration vector for *Lactobacillus* spp. *J Bacteriol* 176:5330, 1994.
- Walker DC, Aoyama K, Klaenhammer TR. Electrotransformation of *Lactobacillus acidophilus* group A1. *FEMS Microbiol Lett* 138:233, 1996.
- Walker SA, Dombroski CS, Klaenhammer TR. Common elements regulating gene expression in temperate and lytic bacteriophages of *Lactococcus* species. *Appl Environ Microbiol* 64:1147, 1998.
- Wang T-T, Lee BH. Plasmids in *Lactobacillus*. *Crit Rev Biotechnol* 17:227, 1997.
- Wang H, Broadbent JR, Kondo JK. Physical and functional characteristics of cell clumping in lactose-positive transconjugants of *Lactococcus lactis* ssp. *lactis* ML3. *J Dairy Sci* 77:375, 1994.
- Wang A, Macrina FL. Streptococcal plasmid pIP501 has a functional *oriT* site. *J Bacteriol* 177:4199, 1995.
- Ward LJ, Brown JC, Davey GP. Identification and sequence analysis of IS1297, an ISS1-like insertion sequence in a *Leuconostoc* strain. *Gene* 174:259, 1996.
- Wei M-Q, Rush CM, Norman JM, Hafner LM, Epping RJ, Timms P. An improved method for the transformation of *Lactobacillus* strains by electroporation. *J Microbiol Meth* 21:97, 1995.
- Williams D. Food enzyme producers face pressure to innovate. *Chem Market Reporter* 253 (June 22):FR16, 1998.
- Woodford N. Glycopeptide-resistant enterococci: a decade of experience. *J Med Microbiol* 47:849, 1998.
- Wycoff HA, Sandine WE, Kondo JK. Transformation of dairy *Leuconostoc* using plasmid vectors from *Bacillus*, *Escherichia*, and *Lactococcus* hosts. *J Dairy Sci* 74:1454, 1991.
- Yu W, Meirau I, Mars A, Johnson E, Dunny G, McKay LL. Novel insertion sequence-like element IS982 in lactococci. *Plasmid* 33:218, 1995.
- Yu W, Gillies K, Kondo JK, Broadbent JR, McKay LL. Loss of plasmid-mediated oligopeptide transport system in lactococci: another reason for slow milk coagulation. *Plasmid* 35:145, 1996.
- Ze-Ze L, Tenreiro R, Brito L, Santos MA, Paveia H. Physical map of the genome of *Oenococcus oeni* PSU-1 and localization of genetic markers. *Microbiol* 144:1145, 1998.
- Zwahlen MC, Mollet B. ISL2, a new mobile genetic element in *Lactobacillus helveticus*. *Mol Gen Genet* 245:334, 1994.

9

Fermented Milks and Cream

Vikram V. Mistry

*South Dakota State University
Brookings, South Dakota*

I. INTRODUCTION

Fermented milks result from the selective growth of specific bacteria in milk. These products have evolved around the world over thousands of years and are believed to have originated in the area that is now the Middle East. These products probably resulted from the need to extend the shelf life of milk in the absence of refrigeration (Kosikowski and Mistry, 1997). Storage of raw milk at ambient temperature probably led to growth of lactic acid and other bacteria. This bacterial activity produced desirable flavors, and, importantly, increased the shelf life of milk because of a high acid content. Procedures of fermented milk production were subsequently refined, the products became popular, and gradually spread to Asia, Europe, and other parts of the world. Consumption is now the highest in European countries, but these products form an important component of the diet in many other countries as well (Table 1).

Today yogurt, buttermilk, and sour cream are probably the most widely consumed fermented milk products, but there are many different types of such products that are either manufactured commercially or produced on a small scale, and sometimes in homes, for local consumption. In addition to being excellent sources of nutrients, these products have become popular because of potential health benefits, which are discussed in Chapter 10.

Table 1 World Consumption of Fermented Milks, 1998

Country	Per capita (kg)	Country	Per capita (kg)
Netherlands	45.0	Czech Republic	10.0
Finland	38.8	Portugal	9.8 (1997)
Sweden	30.0	Hungary	9.4
Denmark	27.3	Poland	7.4
France	26.9	Slovakia	7.4
Iceland	25.3	USA	7.1 (1997)
Germany	25.0	Australia	6.4
Israel	24.8	Argentina	6.0
Norway	19.3	Canada	3.6
Bulgaria	15.6	Ukraine	3.4
Austria	14.7	South Africa	3.1
Spain	14.5	China	0.2

Source: International Dairy Federation. 1999. World Dairy Situation. Bulletin No. 339.

II. MICROORGANISMS USED TO MANUFACTURE FERMENT MILK

Microorganisms used to manufacture fermented milk primarily include those that can ferment lactose to lactic acid and may be either of the mesophilic or thermophilic type. Nomenclature for these organisms has evolved over the years as a greater understanding of their genetics has been acquired. Current nomenclature of selected microorganisms used to manufacture fermented milks is in Table 2. Pure strains of these organisms are readily available from commercial suppliers, but it is not uncommon, especially for small-scale manufacturers, to use product from a previous batch as culture for the next batch. In such instances, there is a potential for quality of the endproduct to vary from batch to batch because of changes in culture characteristics that may occur over repeated transfers. This is especially evident in products that normally require a combination of organisms in a specific ratio, such as rods and cocci in a 1:1 ratio for yogurt. Over repeated transfers as a mixed culture, one of the species is likely to dominate and hence alter the characteristics of the fermentation and consequently flavor and texture qualities of the product.

In addition to lactic acid producers, other types of organisms may also be employed to impart desired flavor or therapeutic properties to fermented products. Examples include organisms that produce diacetyl or acetaldehyde for flavor or small amounts of alcohol in products such as kefir. Organisms such as *Bifido-*

Table 2 Nomenclature of Microorganisms Used in the Manufacture of Fermented Milks

Previous name ^a	Current name
<i>Lactobacillus bulgaricus</i>	<i>Lactobacillus delbrueckii</i> subsp. <i>bulgaricus</i>
<i>Leuconostoc cremoris</i> and <i>Leuconostoc citrovorum</i>	<i>Leuconostoc mesenteroides</i> subsp. <i>cremoris</i>
<i>Leuconostoc dextranicum</i>	<i>Leuconostoc mesenteroides</i> subsp. <i>dextranicum</i>
<i>Streptococcus lactis</i> subsp. <i>cremoris</i> and <i>Streptococcus cremoris</i>	<i>Lactococcus lactis</i> subsp. <i>cremoris</i>
<i>Streptococcus lactis</i> subsp. <i>diacetilactis</i> and <i>Streptococcus diacetilactis</i>	<i>Lactococcus lactis</i> subsp. <i>lactis</i> (biovar. <i>diacetilactis</i>)
<i>Streptococcus lactis</i> subsp. <i>lactis</i>	<i>Lactococcus lactis</i> subsp. <i>lactis</i>
<i>Streptococcus salivarius</i> subsp. <i>thermophilus</i>	<i>Streptococcus thermophilus</i>

^a The names here reflect the most current previous names. Historically, various names have been used for these organisms. For example, *Leuconostoc dextranicum* was previously known as *Streptococcus paracitrovorus*. Such nomenclature can be found in Hammer (1928) and Swithinbank and Newman (1903). Wood and Holzapfel (1995) discuss in detail the nomenclature of lactic acid bacteria. Source: Kosikowski and Mistry (1997)

bacterium spp. and *Lactobacillus acidophilus* are added for therapeutic purposes. *Leuconostocs* are used in products such as cultured buttermilk to produce diacetyl via citrate fermentation (Vedamuthu, 1994). Some functions of organisms for specific applications in fermented milks are given in Table 3, and metabolic pathways are discussed in Chapter 7.

A. Enumeration

Legislation in some countries and codex regulations require the presence of viable organisms in yogurt. In the United States, the National Yogurt Association requires the presence of at least 10 million yogurt bacteria per gram at the time of consumption if manufacturers wish to display the “Live and Active Cultures” symbol on yogurt packages (Kosikowski and Mistry, 1997). Furthermore, many fermented milk products possess therapeutic properties largely because of the presence of selected viable organisms. These organisms have to be present in specified numbers to impart such therapeutic properties. Therefore, the use of proper enumeration procedures is vital. Such procedures have been developed (Dave and Shah, 1996; Frank et al., 1992; International Dairy Federation, 1997a,

Table 3 Functions and Applications of Microorganisms in Fermented Milks

Culture	Function	Application
<i>Lactobacillus delbrueckii</i> subsp. <i>bulgaricus</i>	Acid and flavor	Bulgarian buttermilk, yogurt, kefir
<i>Lactobacillus acidophilus</i>	Acid	Acidophilus milk
<i>Lactobacillus kefir</i>	Acid	Kefir
<i>Streptococcus thermophilus</i>	Acid	Yogurt
<i>Lactococcus lactis</i> subsp. <i>lactis</i> (biovar. <i>diacetylactis</i>)	Acid and flavor	Sour cream, cultured buttermilk
<i>Lactococcus lactis</i> subsp. <i>lactis</i> & <i>Lactococcus lactis</i> subsp. <i>cremoris</i>	Acid	Cultured buttermilk, sour cream
<i>Leuconostoc lactis</i> & <i>Leuconostoc mesenteroides</i> subsp. <i>dextranicum</i>	Flavor	Cultured buttermilk, sour cream, ripened cream butter
<i>Bifidobacterium longum</i>	Acid and flavor	Yogurt
<i>Bifidobacterium bifidum</i>		
<i>Bifidobacterium breve</i>		

Source: Kosikowski and Mistry, 1997.

1997b; Lee et al., 1974; Matalon and Sandine, 1986). Lactic agar is used to enumerate lactic acid bacteria, whereas deMan, Rogosa, and Sharp (MRS) and lactobacillus agars are suitable for lactobacilli. Special consideration is given to products that are made with a combination of cultures. An example is yogurt that is manufactured with rods and cocci and sometimes also with bifidobacteria. It is important not only to enumerate but also differentiate these types of organisms. Enumeration procedures such as those that use yogurt lactic agar are recommended for differentiating between rods and cocci. On this agar, *Streptococcus thermophilus* colonies are small and white and *Lb. delbrueckii* subsp. *bulgaricus* colonies are large and white and have a white cloudy zone.

A critical issue in enumeration of bacteria in cultured products is the occurrence of acid injury to cells, especially during storage of the product. The pH in most fermented milk products drops to below 4.6 and causes sublethal injury to surviving lactic acid bacterial cells. Such sublethally injured cells are not able to multiply in media used in routine counting procedures but require an enriched medium which will help repair the injured cells (Andrew and Russell, 1984; Ray, 1993). Pariente et al. (1987) demonstrated that counts of heat-injured *Lb. casei* were underestimated when *Lactobacillus* selection (LBS) and Rogosa media were used for enumeration. Application of soya trypticase broth to recover injured lactobacilli has been recommended (Briceno-Graciela et al., 1995). *Standard Methods for the Examination of Dairy Products* (Frank et al., 1992) suggests the

use of standard methods agar (SMA) for enumerating injured cells, but this agar is not selective. It can be made more selective by adding 0.02% sodium azide, which does not inhibit lactic acid bacteria but does inhibit others such as enteric bacilli. In a direct epifluorescent filter technique for differential determination of sublethally injured bacterial cells, the RNA of viable cells is stained orange by acridine orange, whereas inactive cells and DNA are stained green (Sto et al., 1986). This characteristic also is applicable to *Lb. delbrueckii* subsp. *bulgaricus*, *S. thermophilus*, and *Lb. acidophilus*. Working with cells injured by freeze drying, de Valdez et al., (1985) demonstrated that highest recovery was obtained on LAPTg agar for various lactobacilli and lactococci.

B. Inhibition of Growth

Development of adequate flavor and texture in fermented milk products requires optimal growth of culture organisms. This is readily attained with proper manufacturing conditions and handling of cultures. If a batch starter is used daily, facilities for aseptic culture transfer and maintenance of cultures should be available (Kosikowski and Mistry, 1997). Presence of substances in milk such as phages and sanitizers can inhibit cultures. Antibiotics have a static effect on bacteria, but yogurt bacteria, *S. thermophilus* and *Lb. delbrueckii* subsp. *bulgaricus*, are particularly sensitive (Reinbold and Reddy, 1974). Penicillin at 0.01 IU/mL of milk will inhibit these organisms, whereas mesophilic lactococci are not as sensitive. It is important, therefore, to test every batch of milk for antibiotics.

Bacteriophages of organisms used to manufacture fermented milks have been identified. Phages of mesophilic lactic acid bacteria are well known to cheese makers but have also been found in buttermilk production facilities. Moineau et al. (1996) isolated 27 different phages from 27 buttermilk plants in the United States. Although not as common as phages of mesophiles, those of thermophiles, such as yogurt bacteria, have also been reported (Kilic et al., 1996) and can arrest the fermentation. Phage control systems have been described (Kosikowski and Mistry, 1997) and involve culture rotation, the use of phage-inhibitory media (Vedamuthu, 1992), and, most important, proper sanitation at the plant. Phage-inhibitory media are usually rich in phosphates to chelate calcium. Some strains of *S. thermophilus* do not grow well in high-phosphate media. Chlorine as a sanitizer is very effective against phages. Sanitizers must be used with caution, however, because residual sanitizers in fermentation vats, piping, or packaging cups will also inhibit starter organisms. The latter is particularly applicable for products that are fermented in consumer cups. Sanitizers such as quaternary ammonium compounds in particular can be a problem. If a residual film of such sanitizers is left on equipment surfaces, the sanitizers are released slowly over time and inhibit culture organisms that come in contact with them (Guirguis and Hickey, 1987a; Miller and Elliker, 1951; Pearce, 1978; Valladao and San-

dine, 1994). Sensitivity is strain dependent but thermophiles are generally more sensitive than mesophilic lactococci (Guirguis and Hickey, 1987a).

Another mode of inhibition in milk is by the naturally present lactoperoxidase system. This system has to be activated for inhibition to occur and requires the presence of the lactoperoxidase enzyme, H_2O_2 , and thiocyanate. Some starter bacteria used to produce fermented products, such as *Lb. acidophilus* and *Lb. delbrueckii* subsp. *bulgaricus*, produce H_2O_2 during fermentation and consequently activate the lactoperoxidase system. Guirguis and Hickey (1987b) concluded that inhibition by this system was strain dependent and that strains most affected were those that produced H_2O_2 . *S. thermophilus* was not inhibited by the lactoperoxidase system.

III. TYPES OF FERMENTED MILKS

Numerous types of fermented milks exist around the world (Kosikowski and Mistry, 1997; Kurmann et al., 1992). Products range from yogurt, which is probably the most widely known, especially in the Western world, to more regional products such as mala (or maziwa lala) of Kenya, which is manufactured using mesophilic cultures, and dahi of India, which is largely made either in the home or by small-scale dairies. Table 4 lists some major types of fermented milk products of the world, and Fig. 1 shows a sampling of such products. There are distinct differences in characteristics between the different types of products, depending on type of organisms and type of milk used. For example, Bulgarian buttermilk has a very strong acid flavor (2–4% lactic acid), whereas yogurt has a milder acidic and acetaldehyde flavor. On the other hand, koumiss, which is traditionally made from mares' milk, is slightly alcoholic, because yeasts are used in its manu-

Table 4 Major Fermented Milks of the World

Acidophilus milk	Kouwonnailio (China)
Bulgarian buttermilk	Maziwalala (Kenya)
Cultured buttermilk	Sour cream
Cultured cream	Yogurt
Kefir	Dahi
Koumiss	Doog
Viili (Scandinavia)	Kishk
Langfil (Scandinavia)	Laban
	Mast
	Yaourt
	Zabady



Figure 1 A sampling of fermented milk products, including cultured drinks (AB Kultur drik, Gefilus, and Glacier Yo), yogurt, liquid yogurt (YOP, Yo-Goat, and Yogurito), yogurt packaged in a tube (Go-Gurt), and buttermilk (Lait Ribot).

facture (Tamime and Robinson, 1988). Texture of products also varies from liquid, such as for cultured buttermilk and liquid yogurt, to thick gel as for yogurt and sour cream. Some products such as viili from Scandinavia are characterized by their ropiness, which is intentionally induced by the use of cultures that produce exopolysaccharides to provide a thick body. Such cultures may also be used to manufacture low-fat yogurts to provide adequate body. Milk used for manufacturing fermented products is largely from the cow, but across the world milk of other species is also employed. In India, for example, the water buffalo is a common source (Aneja, 1997). Yogurt-like products in Iran are produced from milk of sheep or goats, and in some parts of Tibet milk of the yak is used (Kosikowski and Mistry, 1997). The type of milk affects endproduct characteristics partly via influence on growth of culture bacteria.

Thus, fermented milks encompass a wide range of products that possess diverse characteristics and employ a wide range of manufacturing procedures that are designed to promote optimal growth and activity of the chosen culture organisms.

A. Yogurt

The term *yogurt* (yoghurt) encompasses a wide range of products. Yogurt is a fermented dairy product, which is generally manufactured from pasteurized milk.

Its fat content ranges from 0 to over 4% depending on region and legislation. High-temperature pasteurization of the yogurt mix is employed to obtain a smooth and firm body. Nonfat dry milk or stabilizers may also be added to increase the water-holding capacity and therefore improve its body. The latter is particularly applicable to low-fat products.

Several different types of yogurt are commercially available. These include plain (no added flavors), flavored, liquid, carbonated, and low lactose. The flavored yogurts include the sundae-style in which fruit puree is layered at the bottom of the cup and is mixed with the yogurt before consumption. The other type is Swiss-style, in which plain yogurt is gently blended with fruit puree before packaging. Such yogurts require high levels of solids and stabilizer to obtain the desired high viscosity. Liquid yogurts are popular in Europe, Canada, and Japan, and differ from gel-type yogurt in that they are in a homogeneous, pourable state. No whey separation should occur during storage.

Manufacture of yogurt involves several key steps: standardization of mix, homogenization, heat treatment, cooling to incubation temperature, inoculation with yogurt cultures, incubation, cooling, and packaging (Rasic and Kurmann, 1978) (Fig. 2).

1. Starter Organisms

Many countries have their own standards of identity for yogurt with regard to composition as well as starter bacteria (Mareschi and Cuff, 1989). Most coun-

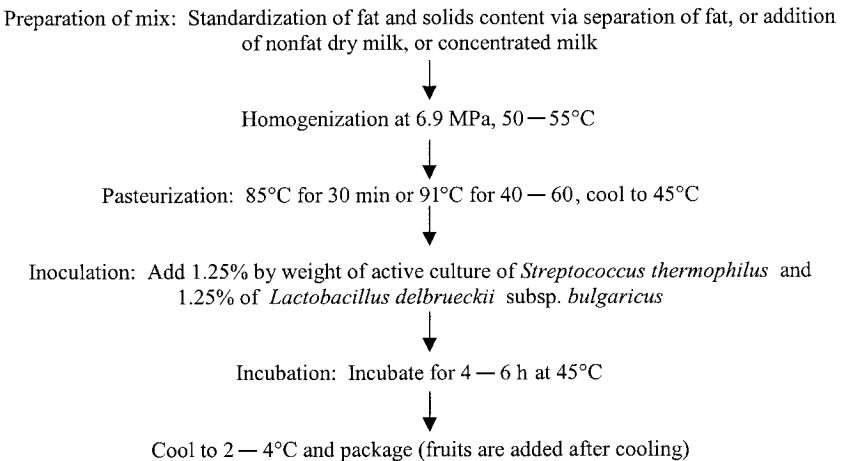

Figure 2 Steps for the manufacture of yogurt. (From Kosikowski and Mistry, 1997.)

tries and codex regulations define yogurt as the product obtained by fermenting milk with a culture that includes *Lb. delbrueckii* subsp. *bulgaricus* and *S. thermophilus*. Some countries permit additional lactic acid bacteria, whereas others, such as Australia, require only *S. thermophilus* and a lactobacillus of choice. The United Kingdom requires *Lb. delbrueckii* subsp. *bulgaricus* to which other lactic acid bacteria can be added.

S. thermophilus (coccus) and *Lb. delbrueckii* subsp. *bulgaricus* (rod) are thermophilic organisms (Fig. 3) and grow best at approximately 45°C but not above 50°C (Chandan, 1992). They are typically added in a 1:1 ratio. Bulk cultures may be prepared separately from pure strains or frozen concentrates may be added directly to the mix. The latter eliminates the need to maintain culture transfer facilities (Kosikowski and Mistry, 1997). Rods and cocci function symbiotically to produce typical yogurt characteristics. Either culture independently is unable to produce the ideal balance of acid and flavor. *S. thermophilus* initiates lactic acid production and lowers the oxygen level, which stimulates growth of *Lb. delbrueckii* subsp. *bulgaricus* (Vedamuthu, 1992). The pH is lowered to approximately 5 by the cocci and then to less than 4 by the rods. The rods in turn promote growth of *S. thermophilus* via production of peptides and amino acids.

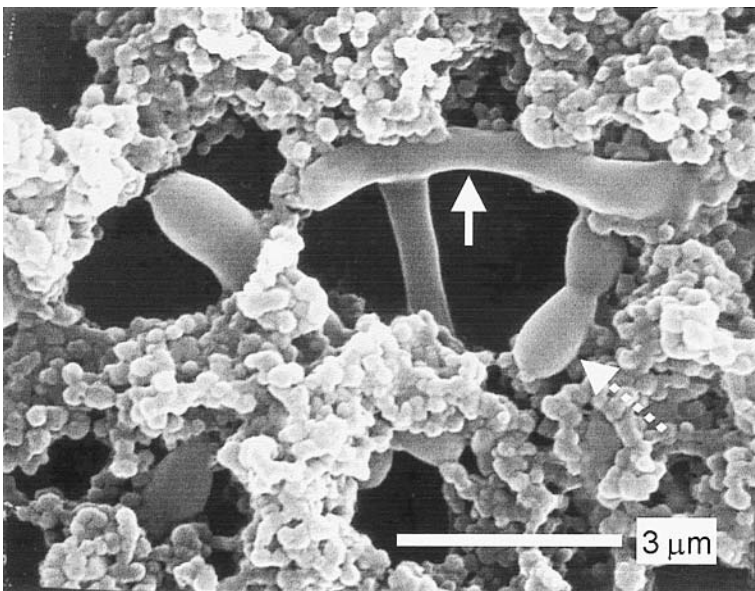

Figure 3 Electronmicrograph of yogurt showing rods (solid white arrow) and cocci (dotted white arrow) embedded within the product.

S. thermophilus is more sensitive to acid than is *Lb. delbrueckii* subsp. *bulgaricus*; hence during extended storage of yogurt, the former (cocci) are likely to be injured by the acid and gradually die off. Therefore, although the initial ratio of rods to cocci may be 1:1, this ratio may change in favor of lactobacilli during storage of the yogurt. As the rate of acid and flavor production is strain dependent, the rod and coccal strains should be selected so there is a balance of acid and acetaldehyde production (Vedamuthu, 1992). Rate of acid production alone should not be the criterion for strain selection. Acetaldehyde is produced by both *S. thermophilus* and *Lb. delbrueckii* subsp. *bulgaricus* (Wilkins et al., 1986). Both organisms produce threonine aldolase which helps convert threonine to acetaldehyde but lactose is also a source.

It is now common in the yogurt industry, particularly in Europe, to enhance the body of yogurt by using cultures that produce exopolysaccharide (Hassan et al., 1996; Lavezzari et al., 1998). Some strains of lactic acid bacteria, including the thermophilic yogurt bacteria, can produce exopolysaccharides that act as stabilizers and thicken the body of yogurt. The polysaccharides can be extracellular or in encapsulated form (Hassan et al., 1996). Some strains of cultures produce polysaccharides that can lead to a ropy texture, whereas others provide a thickening effect without ropiness (Lavezzari et al., 1998). This may be important, because criteria for sensory evaluation of yogurt generally view ropiness as a defect (Bodyfelt et al., 1988).

In recent years bifidobacteria-containing yogurt has become popular in Japan, Canada, France, and Germany. Such yogurt is manufactured either with bifidobacteria singly or as mixed cultures with *Lb. acidophilus* and *S. thermophilus* and provide therapeutic properties to yogurt (Rasic and Kurmann, 1983). Bifidobacteria of human origin are preferred and include *Bifidobacterium breve*, *Bi. longum*, *Bi. infantis*, and *Bi. bifidum*. An inoculum rate of >10% has to be used, because bifidobacteria are slow acid producers. Incubation is at 36–42° C for 6–8 h to enable curd formation and provide viable counts of up to 100 million per gram in the final product. An advantage in using bifidobacteria is that over-acidification does not occur in the yogurt during production and storage. Bifidobacteria yogurt therefore has a milder (less acidic) taste. To ensure viability during storage of yogurt, proper strains of bifidobacteria must be selected (Martin and Chou, 1992).

2. Defects

Yogurt by nature is a high-acid (low pH) product and is therefore inherently protected against defects caused by most contaminating organisms. Furthermore, the high pasteurization temperature used in processing the mix eliminates most contaminating bacteria. Nevertheless, certain defects, some microbially induced,

may occur. Perhaps the most common defect is high acid and consequently high acetaldehyde flavor (Vedamuthu, 1992). This may develop under improper manufacturing and storage conditions. If the rods and cocci are maintained as a mixed culture, after repeated transfers at high temperature rods will dominate the culture. They then become the primary acid producers when used to make yogurt and produce excessive amounts of acid (over 2%). This can be prevented by maintaining the two cultures separately and adding them in a 1:1 ratio at the time of inoculation of the mix during manufacture of yogurt (Kosikowski and Mistry, 1997). Another critical factor is the rapid cooling of yogurt after incubation to prevent continued growth of lactobacilli. Many manufacturers use blast tunnels for cooling to 10°C within 50 min. Excessive acid production may also lead to body and texture defects such as shrinkage of curd and wheying-off. Other texture defects may also occur in yogurt, such as weak or excessively heavy body, which are generally related to improper use of stabilizers. Proper selection and use of ingredients, especially stabilizers in the mix, can address these defects. Yogurt manufacturers often add 2–4% nonfat dry milk to increase the total solids content to over 15%. This helps to develop a firm body (Kosikowski and Mistry, 1997; Tamime and Robinson, 1985), and is especially useful in low-fat and nonfat yogurts. A disadvantage is that the resulting yogurt will have a high lactose content (approximately 6%) that will allow the lactic fermentation to continue. Acidity of such yogurts is therefore high. An alternative is to concentrate milk by ultrafiltration to raise the protein content and lower the lactose level (Mistry and Hassan, 1992; Rasic et al., 1992). The protein concentration that can be used with such procedures is <5.6%, since excessive fortification leads to an undesirably firm body (Mistry and Hassan, 1992).

Another microbially induced defect is bitterness. This occurs if the milk supply contains spore-forming organisms such as *Bacillus subtilis* or *B. cereus*. Spores of these organisms are able to survive high heat treatment. Yeasts and molds are acid tolerant. Therefore, contamination by yeasts and molds can be a problem, particularly in fruit-flavored yogurts if poor-quality contaminated fruit preserves are used.

B. Cultured Buttermilk

Cultured buttermilk is a lightly salted fermented milk product that is manufactured from nonfat or low-fat milk using mesophilic cultures and flavor-producing organisms. Unlike yogurt, the flavor of buttermilk includes lactic acid, diacetyl, and acetic acid. Diacetyl is obtained from citric acid fermentation during manufacture of buttermilk. Cultured buttermilk should have a smooth thick body, with the correct balance of acid and diacetyl flavor (Vedamuthu, 1985). Steps in the manufacture of buttermilk are summarized in Fig. 4.

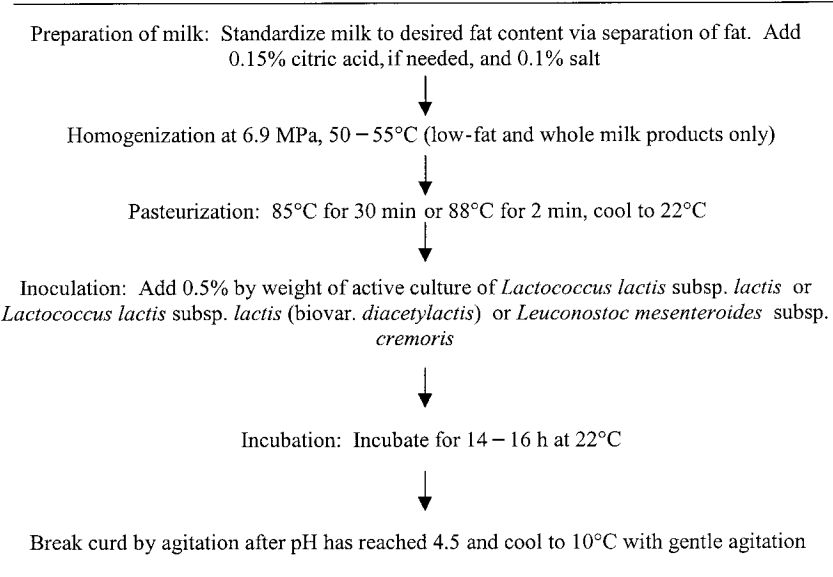

Figure 4 Steps for the manufacture of cultured buttermilk. (From Kosikowski and Mistry, 1997.)

1. Starter Organisms

Cultured buttermilk is produced with combinations of mesophilic lactic acid bacteria that will produce lactic acid as well as diacetyl. Species used include *Lactococcus lactis* subsp. *cremoris*, *Leuconostoc mesenteroides* subsp. *cremoris*, and *Lc. lactis* subsp. *lactis* (biovar. *diacetylactis*). The latter two produce diacetyl and small amounts of carbon dioxide. *Lc. lactis* subsp. *lactis* (biovar. *diacetylactis*) also produces acetaldehyde, which is not desirable in buttermilk, and therefore this bacterium should be used with caution. The lactic acid producers thrive on lactose, whereas the flavor producers require the presence of sufficient citric acid to produce diacetyl. The naturally present citric acid in milk should be supplemented by the addition of sodium citrate (0.1–0.15%). The flavor producers do not produce an appreciable amount of lactic acid but do require acidic conditions for proper growth and fermentation of citrate. Therefore, sufficient activity by the lactic acid producers is necessary (pH 5) before flavor producers can function. Levata-Jovanovic and Sandine (1997) have reported on the use of a *Leuc. mesenteroides* subsp. *cremoris* strain in combination with a ropy *Lc. lactis* subsp. *cremoris* culture for improving the flavor and texture of buttermilk.

An important advantage of using leuconostocs is that these organisms are relatively insensitive to phages.

Flavor producers are rather temperature sensitive. If the temperature of incubation is maintained at 27°C instead of the optimum 22°C, they will not produce sufficient diacetyl and consequently acid rather than a balance of acid and diacetyl flavor will dominate the finished product (Kosikowski and Mistry, 1997). Diacetyl-producing bacteria also possess an enzyme that converts diacetyl to acetyl methyl carbinol (acetoin). This results in a loss in the quantity of diacetyl in buttermilk (Vedamuthu, 1994). Hence, production of cultured buttermilk requires proper selection of culture bacteria as well as manufacturing conditions that will induce balanced growth of acid and flavor producers.

Cultured buttermilk typically has a thick, homogeneous body. Vedamuthu and Shah (1983) patented a procedure for manufacturing such a product using a mixture of slime-producing *Lc. lactis* subsp. *cremoris* and non-slime producing *Lc. lactis* subsp. *cremoris* and/or *Lc. lactis* subsp. *lactis*. Ropiness occurred only if >80% of the culture mixture was a slime producer.

2. Defects

In many respects, cultured buttermilk is a delicate product that can have defects if proper care is not taken during manufacture. On the other hand, culture characteristics and proper manufacturing conditions have been well documented, and, if employed, good-quality product can be readily obtained. Many defects of cultured buttermilk can be linked to improper culture usage, whereas others are related to manufacturing procedures. Culture-related defects can be flavor defects and may indirectly also lead to body defects. Even buttermilk produced under the best sanitary conditions may lack flavor (flat flavor) if the environment is not optimal for the growth of flavor producers. For example, a high incubation temperature (27°C) discourages growth of flavor producers; therefore insufficient diacetyl will be present. Such defects can be prevented by ensuring that the acid-producing culture is active, because the flavor producers will be activated only after sufficient acid has been produced (0.8–0.85%, pH 5) and incubating at 22°C. Milk should be supplemented with citrate, and after the curd has been broken at the optimum pH, the product should be rapidly cooled with gentle agitation. This will prevent degradation of diacetyl. If incubation is not monitored and if fermentation is not halted by cooling, acid production will continue and may even exceed 1%. This process is not reversible and produces a highly acidic product with a loss of diacetyl (Vedamuthu, 1994). Excessive acidity will also lead to wheying-off because of a lowered water-holding capacity of the proteins. Such wheying-off may also result from excessive and high-speed agitation during cooling after fermentation is completed (Kosikowski and Mistry, 1997). During storage such

a product will separate into whey and a heavy protein mass that settles to the bottom.

A weak culture that is contaminated with organisms such as psychrotrophs and coliforms will lead to unclean, and, in extreme conditions, bitter flavors. Contaminating bacteria such as coliforms and *Pseudomonas* spp. possess a relatively high level of diacetyl reductase which degrades diacetyl (Elliker, 1945; Seitz et al., 1963). One strain of *Enterobacter aerogenes* had an activity of 345 units of enzyme protein per milligram compared with 100 units for *Lc. lactis* subsp. *lactis* (biovar. *diacetylactis*) (Seitz et al., 1963). Such enzyme activity leads to a product that lacks flavor. Good manufacturing and sanitation practices are therefore vital and can easily prevent such defects. Proper starter maintenance, including replacement of the mother culture at regular intervals, is also a good practice to ensure continued high activity of the starter culture.

Some of the aforementioned culture-related defects will eventually lead to body and texture defects. For example, if the culture lacks adequate activity and if the product is cooled at low acidity, the finished product will not have optimum viscosity. In contrast, excessive viscosity can result from cultures such as *Lc. lactis* subsp. *lactis*, which form long chains. Some contaminants produce slime, which results in a highly viscous product.

C. Sour Cream and Crème Fraîche

The two main fermented cream products are sour cream and crème fraîche. The later originated in France but is now also used in other countries. Because of their high fat content, 18 and 50%, respectively, they are used for dips and toppings rather than for direct consumption. Cultures used for these products and manufacturing procedures are similar to those for cultured buttermilk (Kosikowski and Mistry, 1997). The high-fat and solids contents provide these products with a thick and heavy body. The manufacturing procedure for sour cream is especially designed to produce a very thick body. Sour cream typically has a clean acidic flavor with hints of diacetyl. Mesophilic lactic acid and flavor-producing cultures are used along with double homogenizing and a small amount of rennet for developing body (Fig. 5). Crème fraîche, on the other hand, is also manufactured with the same cultures but the pH is higher (6.2–6.3).

As sour cream is a high-fat product (approximately 70% fat on dry basis), manufacturing a low-fat, and, particularly a fat-free product, is challenging. Simply replacing the fat with moisture, as is done in most low-fat cheeses, does not provide the required thick and smooth body of sour cream. Thickening agents such as starches, stabilizers, and fat replacers therefore play an important role in these products. Lee and White (1991) demonstrated that good body and texture in sour cream of 5 and 10.5% fat could be obtained with gelatin, modified food starch, or methoxyl pectin. Addition of rennet helps firm the body but also leads

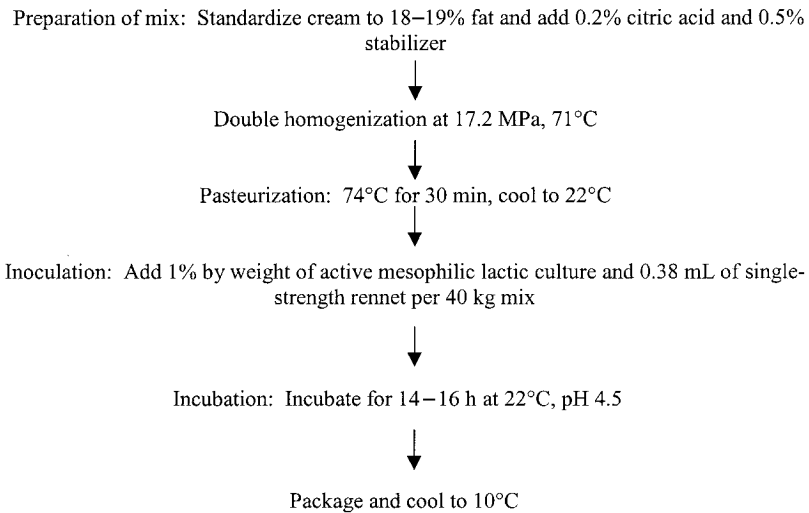

Figure 5 Steps for the manufacture of sour cream. (From Kosikowski and Mistry, 1997.)

to syneresis and proteolytic activity. The use of a starch-based texturizing agent has also been suggested (Dunn and Finocchiaro, 1997). This agent consists of an insoluble microparticle (titanium dioxide), xanthan gum, and pregelatinized starch. Commercial milk or egg protein-based microparticulated products used as fat replacers have application in reduced-fat sour cream production (Singer et al., 1992) (Fig. 6). The aforementioned procedures provide adequate body to low-fat sour cream, but development of proper balanced flavor is also important. Flavor-delivery systems have been developed that consist of fat globules (Singer et al., 1993) or polyhydroxyalkanoates (Yalpani, 1993) in which large amounts of fat-soluble flavor compounds are included. When these systems are incorporated into low-fat and fat-free sour cream, the fat-soluble flavor compounds are released and complement other compounds that are produced by the starter bacteria.

1. Starter Organisms and Product Defects

Most of the culture issues discussed previously for cultured buttermilk apply to sour cream as well. As with most fermented milk products, good-quality sour cream can keep for a long time (4 weeks) under refrigeration, because the high-

Preparation of mix: Blend 3× ultrafiltered skim milk (51.4%), nonfat dry milk (5.4%), 14% fat cream (6.6%), gelatin (0.2%), sodium citrate (0.1%), water (26.1%)

↓

Homogenization at 17.2 MPa

↓

Pasteurization: 85°C for 10–30 min

↓

Add microparticulated protein (10%). Hold at 85°C for 30 s, cool to 21–26°C

↓

Inoculation: Add active mesophilic lactic culture and 0.0015% of single-strength rennet and flavor

↓

Incubation: Incubate for 12–22 h at 21–26°C, pH 4.5

↓

Package and cool to 10°C

Figure 6 Steps for the manufacture of reduced fat sour cream. (From Singer et al., 1992.)

acid content prevents growth of contaminants. During extended storage, however, enzymes of bacteria that survived pasteurization may cause development of bitter and unclean flavors via proteolysis. Good manufacturing and sanitation practices should be employed to prevent such defects.

D. Acidophilus Milk

Acidophilus milk is a fermented milk produced mainly by the use of lactobacilli and is believed to have therapeutic properties (Gilliland, 1989). It can have an acid content of up to 2%, which is unpleasant to some, so consumption is limited. Manufacture of this product first involves sterilization of nonfat or low-fat milk followed by inoculation (5%) with an active *Lb. acidophilus* culture. Incubation is for 24 h at 36°C, and this generally results in a titratable acidity of 1%. After incubation, the product is cooled and packaged. In addition to tartness, the product also has a strong cooked flavor from sterilization of milk before fermentation. Because of these qualities, the product is not popular. These drawbacks have been overcome in a product from Finland, which is manufactured by fermenting demineralized, lactose-hydrolyzed whey with *Lb. casei* GG and then adding fruit flavors.

An alternative for ingestion of *Lb. acidophilus* is sweet acidophilus milk. Initially, this product contained only *Lb. acidophilus* (Speck, 1975) but now also includes bifidobacteria. Pasteurized, low-fat, skim, or whole fluid milk is packaged with added viable *Lb. acidophilus* and bifidobacteria. As the inoculated fluid milk is held refrigerated, growth of these bacteria does not occur during storage but occurs in the intestinal tract after consumption. Such growth depends on strain of *Lb. acidophilus* used (Collins and Hartlein, 1982). Because these organisms are present, the milk must always be refrigerated. Shelf life under such conditions is 2 weeks. Extended storage and/or storage at high temperatures will lead to curdling of milk from acid produced by the added bacteria. A similar Swedish fluid milk product contains *Lb. reuteri* in addition to *Lb. acidophilus* and bifidobacteria.

E. Kefir

Kefir is originally a Russian liquid fermented milk product (Tamime et al., 1999). Approximately equal amounts of lactic acid and alcohol are produced during fermentation. Typical flavor results from a balance between lactic acid, diacetyl, aldehyde, ethanol, and acetone. Fizz is provided by the carbon dioxide that is also produced during fermentation. In the manufacture of kefir, milk is heated to 85°C for 30 min and cooled to an inoculation temperature of 22°C. It is then inoculated with kefir grains and fermentation occurs over 12–16 h. The kefir grains are then filtered out and reused.

1. Starter Organisms

Kefir grains consisting of yeasts, bacteria, and polysaccharides are used for kefir production (Tamime and Marshall, 1997). The yeasts include *Saccharomyces kefir* and *Torula* spp. or *Candida kefir* and bacteria include *Lb. kefir*, leuconostocs, lactococci, and various others. Takizawa et al. (1998) isolated 120 strains of lactobacilli from kefir grains; the most prominent was *Lb. kefirgranum*. The grains require proper care and should be held using routine sanitary practices. Contaminants such as coliforms, micrococci, and bacilli, if present, will lead to a variety of flavor defects.

Kefir-like products with only small amounts of alcohol and with flavors such as strawberry are also manufactured in the United States. Yeasts and various *Lactobacillus* spp. and *Lactococcus* spp. are used.

F. Koumiss

Koumiss also is a product of Russian origin and is largely used in that country for therapeutic purposes (Kosikowski and Mistry, 1997; Moreau, 1992). It is

made with a combined acid and alcohol fermentation traditionally from mare's milk but cow's milk also can be used. Even though the acid content of koumiss is high, no curd is visible because of the relatively low protein content of mare's milk (2%) (Kosikowski and Mistry, 1997). Fermentation is accomplished with a combination of *Lb. delbrueckii* subsp. *bulgaricus* and a lactose-fermenting yeast, *Torula* spp. The finished product contains 1.0–1.8% lactic acid, 1.0–2.5% ethanol, and carbon dioxide. The latter makes for a frothy product.

G. Fermented Milks of Scandinavia

Scandinavians are among the highest consumers of fermented milk products. It is not surprising, therefore, that some unique fermented products have originated in Scandinavian countries. Examples include viili, langfil, keldermilk, skyr, ymer, and several others. Some of these products possess unique characteristics such as a heavy, ropy body obtained by the use of specially selected cultures, which, in some instances, includes mold (Tamime and Marshall, 1997; Tamime and Robinson, 1988).

Viili is a fermented product of Finland that may be either plain or flavored with fruit. The fat content may vary from 2 to almost 12%, depending on classification (such as low fat, full fat). Milk is heated to a high temperature (83°C for 20–25 min), tempered to the incubation temperature of 20°C, and inoculated with 4% starter culture consisting of *Lc. lactis* subsp. *lactis*, a diacetylactis culture, *Leuc. mesenteroides* subsp. *cremoris*, and *Geotrichum candidum*, a mold. Incubation occurs in consumer cups at 20°C for 24 h (final acidity of 0.9%). The purpose of incubation in consumer cups is to allow fat to rise to the surface during incubation where the geotrichum mold will grow and contribute to the typical musty aroma. Furthermore, complex carbohydrates formed by the organisms used give the product a heavy, ropy characteristic.

Ymer is a fermented product of Denmark that has a high protein content of 5–6%. Current commercial procedures use ultrafiltration technology to concentrate the milk protein before fermentation (Tamime and Marshall, 1997). Concentration by some of the more traditional procedures involves either allowing curd to drain or applying heat to curd to induce syneresis. Before fermentation, milk receives a high-heat treatment (90–95°C for 3 min). Incubation is at 20–22°C with an inoculum consisting of *Lc. lactis* subsp. *lactis* (biovar. *diacetilactis*) and *Leuc. mesenteroides* subsp. *cremoris*. Consequently, the product has a pleasant acidic flavor balanced with hints of diacetyl.

Another concentrated fermented product of Scandinavia is skyr. This product is from Iceland and has almost 13% protein. Such a high concentration is achieved commercially with the help of a centrifugal separator similar to one used in the manufacture of quarg. Skim milk is fermented with thermophilic lactic acid bacteria similar to those used for yogurt along with lactose-fermenting

yeast. Small amounts of rennet may also be added to obtain proper body. With active cultures, a pH of 4.6 is obtained within 4–6 h at 40°C. After an additional 18 h at 18–20°C, the pH drops to 4, the product is pasteurized, and is then centrifuged at 35–40°C for concentration. Because of the presence of yeast, ethanol occurs in the final product along with lactic acid, diacetyl, acetaldehyde, and acetic acid.

H. Fermented Milks of India

India, the largest milk-producing country in the world today, has a long history of dairying (Aneja, 1997). Production and consumption of milk and milk products date back many thousands of years. Today, numerous indigenous products are available locally. Of these, fermented milk products such as dahi, lassi, srikhand, and misti doi are important parts of the diet.

Dahi is a product made by fermenting milk of the cow or water buffalo milk with lactic acid bacteria. It has a clean, acidic flavor with slight hints of diacetyl. The texture is similar to that of yogurt. Much of the dahi consumed in India is either made at home or by small dairies. In both instances, the culture usually consists of the previous day's product, but pure cultures are also available. Hence, composition of culture and consequently flavor can vary from batch to batch. The legal standards of identity for dahi that is produced commercially and sold in the market are the same as for milk from which dahi is made (Aneja, 1997). The manufacturing procedure for dahi is simple. Milk of the cow, water buffalo, or a mixture is briefly boiled and cooled to room temperature. It is then inoculated with 0.5–1.0% culture and incubated at room temperature for 12–16 h. With an active culture, the final pH is 4.5–4.7. Because room temperature in tropical countries varies according to the season, it is not uncommon to find thermophilic cultures in dahi. Dahi typically contains a mixture of *S. thermophilus*, *Lb. delbrueckii* subsp. *bulgaricus*, *Lc. lactis* subsp. *lactis*, *Lc. lactis* subsp. *cremoris*, *Lc. lactis* subsp. *lactis* (biovar. *diacetyllactis*), *Lb. helveticus*, *Lb. casei*, and *Lb. acidophilus* (Masud et al., 1991). The initial boiling step eliminates undesirable organisms from the milk, but it is important to have an active culture. After repeated transfers, the culture may lack activity and, in the absence of adequate acid production, undesirable flavors from growth of yeasts and mold may occur. Because yeasts tolerate acid, it is important to prevent postheating contamination of the milk with these microbes.

Lactic acid bacteria of dahi have antimicrobial effects against pathogenic and spoilage bacteria (Balasubramanyam and Varadaraj, 1994; Dave et al., 1992; Srinivasan et al., 1995). Some of these effects come from cell-free extracts and are believed to be associated with production of H₂O₂ by lactobacilli and bacteriocin-like compounds by some lactococci (de Vuyst and Vandamme, 1994).

Dahi is typically stored at room temperature; hence lactic acid continues to develop rapidly after its manufacture. Researchers have attempted to eliminate this by introducing nisin (25 IU/mL) in dahi after fermentation is completed (Kumar et al., 1998).

Dahi is consumed as such and is also used as a base for producing other products. Examples include lassi, srikhand, and ghee. Lassi is a liquid product that is manufactured by blending water and dahi and mixing to a uniform consistency. The ratio of dahi to water depends on the consistency desired. The product is lightly salted or sweetened.

Srikhand is a popular product that is manufactured at home and also commercially (Patel and Chakraborty, 1988). Fresh dahi is drained either with a cheesecloth overnight or with the help of a centrifuge. The drained curd is mixed with an equal proportion of sugar and enough cream to adjust the fat content to 5–6%. Additional flavorings such as fruits, nuts, and spices may be added. The final product has 40–45% moisture, 5–6% fat, 40–45% sugar, and a shelf life of at least 30–35 days at 10°C (Patel and Chakraborty, 1987). Postproduction acidification is restricted by the presence of a large amount of sugar, but spoilage occurs through growth of yeasts and mold and the presence of heat-stable proteolytic and lipolytic enzymes that cause undesirable flavors. The shelf life can be improved to almost 2 months by pasteurizing the product before packaging (Prapapati et al., 1991). The use of nisin as a preservative has also been suggested (Sarkar et al., 1996b). It is also important to ensure that good-quality sugar is used, such as that which is hot-air treated to improve the microbial quality of srikhand (Patel and Chakraborty, 1987). Antibacterial effects of dahi described above also apply to srikhand (Sarkar et al., 1996a).

Ghee is clarified milk fat and has been used for cooking in India for thousands of years. Although it is not a fermented product, some procedures to manufacture ghee use dahi as a base. Dahi, when churned, is separated into a fat-rich product (butter) and buttermilk. Butter is then heated to 110–120°C, cooled, and filtered. When cooled, it has a granular texture. Much of the flavor of this product results from metabolites of the lactic fermentation during dahi manufacture.

A fermented product similar to dahi called misti doi is popular in eastern India. The manufacturing procedure is similar to that of dahi except that before boiling 6–6.5% sugar is added to milk. The intense heating concentrates milk and gives it a slight brownish color. Approximately 1% culture (previous day's product) is added and incubation occurs at approximately 40°C for 12–15 h. Thermophilic lactic organisms predominate. For example, in one study, 45% of total isolates were *S. thermophilus*, 35% were *S. lactis*, and 20% were *Enterococcus faecalis* (Sarkar et al., 1992). Although this product is commonly produced at home and in small-scale dairies, standardized commercial procedures for large-scale production have been developed.

IV. FERMENTED MILKS OF THE MIDDLE EAST

Fermented milk products have a long history in Middle Eastern countries (El-Gendy, 1983). Popular products include laban rayeb, labneh (concentrated yogurt), kishk, and zabady. Other regional names for some of these products also exist. Laban rayab is traditionally prepared by pouring unhomogenized whole milk in pots and held at room temperature. Fat rises to the surface and is removed. The defatted milk undergoes a natural fermentation and then is ready for consumption. Variations of this product are laban khad and laban zeer. The former is prepared by allowing milk to ferment in a goat pelt, whereas the latter is made in earthenware pots called zeer which are used for incubation. The season, and hence the temperature, will determine the dominating microflora of these products. Generally, lactococci dominate in the cold season and lactobacilli in the warm season. Laban zeer is used to make another highly nutritious product called kishk. To prepare this product, laban zeer is mixed with wheat grains that have been softened by boiling in water, sun-dried, and ground. The mixture undergoes a 24-h fermentation. The product, now with high viscosity, is divided into small pieces and then sun-dried and stored until consumed. Spices may be added. Kishk, which has approximately 8% moisture and 1.85% acidity, has a shelf life of several years (El-Gendy, 1983).

A concentrated fermented product called labneh that has 7–10% fat is produced in several Arabian countries. It is made at home using traditional procedures as well as on a large scale in dairies. The basic procedure for this product involves concentration of milk after fermentation is completed. For commercial production, skim or whole milk is fermented with yogurt cultures, but strains that produce exopolysaccharides are not used because of the difficulty in removing whey after fermentation (Tamime and Robinson, 1988). The fermented product is then separated with the help of centrifugal separators such as those used in manufacturing quarg. Alternatively, milk is fermented after concentration by ultrafiltration to the desired composition. A traditional product of Egypt similar to labneh is zabady, which is made by fermenting milk that has been concentrated by boiling with thermophilic cultures in porcelain containers (El-Gendy, 1983).

REFERENCES

- Andrew MHE, Russell AD. *The Revival of Injured Microbes*. New York: Academic Press, 1984.
- Aneja RP. Traditional dairy delicacies. In: Gupta PR, ed. *Dairy India*. New Delhi: PR Gupta. 1997, pp 371–386.
- Balasubramanyan BV, Varadaraj MC. Dahi as a potential source of lactic acid bacteria active against foodborne pathogenic and spoilage bacteria. *J Food Sci Technol-Mysore* 31:241–243, 1994.

- Bodyfelt FW, Tobias J, Trout GM. The Sensory Evaluation of Dairy Products. New York: Van Nostrand Reinhold, 1988.
- Briceno AG, Martinez R. Comparison of methodologies for the detection and enumeration of lactic acid bacteria in yogurt. Arch Latinoam Nutr 45:207–212, 1995.
- Chandan RC. Yogurt. In: Hui YH, ed. Dairy Science and Technology Handbook. Vol 2. Product Manufacturing. New York: VCH, 1992, pp 1–56.
- Collins EB, Hartlein K. Influence of temperature of lactobacilli on nonfermented acidophilus milks. J Dairy Sci 65:883–886, 1982.
- Dave RI, Shah NP. Evaluation of media for selective enumeration of *Streptococcus thermophilus*, *Lactobacillus delbrueckii* subsp. *bulgaricus*, *Lactobacillus acidophilus*, and bifidobacteria. J Dairy Sci 79:1529–1536, 1996.
- Dave RI, Dave JM, Sannabhadti SS. Antibacterial activity of buffalo milk dahi prepared using *S. thermophilus* strains as starter culture. Indian J Dairy Sci 45:607–610, 1992.
- de Valdez GF, de Giorio GS, Ruiz-Holgado AA, Oliver G. Influence of the recovery medium on the viability of injured freeze-dried lactic acid bacteria. Milchwissenschaft 40:518–520, 1985.
- de Vuyst L, Vandamme EJ. Bacteriocins of Lactic Acid Bacteria: Microbiology, Genetics, and Applications. New York: Blackie, 1994.
- Dunn JM, Finocchiaro ET. Starch-based texturizing agents and methods of manufacture. US Patent 5614243:Mar 25, 1997.
- El-Gendy SM. Fermented foods of Egypt and the Middle East. J Food Prot 46:358–367, 1983.
- Elliker PR. Effect of various bacteria on diacetyl content and flavor of butter. J Dairy Sci 28:93–102, 1945.
- Frank JF, Christen GL, Bullerman LB. Tests for groups of microorganisms. In: Marshall RT, ed. Standard Methods for the Examination of Dairy Products. 16th Ed. Washington, DC: Am Public Health Association 1992, pp 278–279.
- Gilliland SE. Acidophilus milk products: A review of potential benefits to consumers. J Dairy Sci 72:2483–2494, 1989.
- Guirguis N, Hickey MW. Factors affecting the performance of thermophilic starters. 1. Sensitivity to dairy sanitizers. Aust J Dairy Technol 42:11–13, 1987a.
- Guirguis N, Hickey MW. Factors affecting the performance of thermophilic starters. 2. Sensitivity to the lactoperoxidase system. Aust J Dairy Technol 42:14–16, 1987b.
- Hammer BW. Dairy Bacteriology. New York: Wiley, 1928.
- Hassan AN, Frank JF, Schmidt KA, Shalabi SI. Rheological properties of yogurt made with encapsulated nonropy lactic cultures. J Dairy Sci 79:2091–2097, 1996.
- International Dairy Federation. Mesophilic Starter Cultures. Enumeration of Citrate Fermenting Lactic Acid Bacteria: Int Dairy Fed Standard 180. Brussels: IDF, 1997a.
- International Dairy Federation. Yogurt. Enumeration of Characteristic Microorganisms: Int Dairy Fed Standard 117B. Brussels: IDF, 1997b.
- International Dairy Federation. World Dairy Situation, Bulletin 339. Brussels: IDF, 1999.
- Kilic AO, Pavlova SI, Ma W, Tao L. Analysis of lactobacillus phages and bacteriocins in American dairy products and characterization of a phage isolated from yogurt. Appl Environ Microbiol 62:2111–2116, 1996.

- Kosikowski FV, Mistry VV. Cheese and Fermented Milk Foods. Vol 1. Origins and Principles. Westport, CT: Kosikowski, 1997.
- Kumar R, Sarkar S, Misra AK. Effect of incorporation of nisin on the quality of dahi. *J Dairying Foods Home Sci* 17:13–24, 1998.
- Kurmann JA, Rasic JL, Kroger M. Encyclopedia of Fermented Fresh Milk Products. New York: Van Nostrand Reinhold, 1992.
- Lavezzari D, Sozzi T, Pirovano F. Microorganisms producing polysaccharides: differentiation between ropy and thickening strains. In: *Texture of Fermented Milk Products and Dairy Desserts*. Brussels: IDF, 1998, pp 71–77.
- Lee FY, White CH. Effects of stabilizers and rennet on sensory and physical properties in lowfat sour cream. *J Dairy Sci* 74:(Suppl 1) 126 (Abstr), 1991.
- Lee SY, Vedamuthu ER, Washam CJ, Reinbold GW. An agar medium for the differential enumeration of yogurt starter bacteria. *J Milk Food Technol* 37:272–276, 1974.
- Levata-Jovanovic M, Sandine WE. A method to use *Leuconostoc mesenteroides* subsp. *cremoris* 91404 to improve milk fermentations. *J Dairy Sci* 80:11–18, 1997.
- Mareschi JP, Cueff A. Essential characteristics of yogurt and regulation around the world. In: Chandan RC, ed. *Yogurt: Nutritional and Health Properties*. McLean, VA: National Yogurt Association, 1989, pp 11–28.
- Martin JH, Chou KM. Selection of bifidobacteria for use as dietary adjuncts in cultured dairy foods: 1—tolerance to pH of yogurt. *Cultured Dairy Prod J* 27:(4)21–26, 1992.
- Masud T, Sultana K, Shah MA. Incidence of lactic acid bacteria isolated from indigenous dahi. *Asian Australasian J Animal Sci* 4:329–331, 1991.
- Matalon ME, Sandine WE. Improved media for differentiation of rods and cocci in yogurt. *J Dairy Sci* 69:2569–2576, 1986.
- Miller DD, Elliker PR. Effect of quaternary ammonium compounds on activity of lactic acid starter bacteria in milk and cheese. *J Dairy Sci* 34:279–286, 1951.
- Mistry VV, Hassan HN. Manufacture of yogurt from a high milk protein powder. *J Dairy Sci* 75:947–957, 1992.
- Moineau S, Borakev M, Holler BJ, Walker SA, Kondo JK, Vedamuthu ER, Vandenberg PA. Isolation and characterization of lactococcal bacteriophages from cultured buttermilk plants in the United States. *J Dairy Sci* 79:2104–2111, 1996.
- Moreau M. Mare milk. *Equ'idee Bull d'information sur les Equides* 6:55–63, 1992.
- Pariante JM, Ryan JJ, Adkinson RW, Gough RH. Enumeration of heat injured *Lactobacillus casei* using five different growth media. *J Dairy Sci* 70:(Suppl 1) 80 (Abstr), 1987.
- Patel RS, Chakraborty BK. Storage stability of shrikhand manufactured from different sources of milk solids. *Jpn J Dairy Food Sci* 36:209–216, 1987.
- Patel RS, Chakraborty BK. Shrikhand—a review. *Indian J Dairy Sci* 41:109–115, 1988.
- Pearce LE. Quaternary ammonium detergent sanitizers and starter activity. *NZ J Dairy Sci Technol* 13:56–58, 1978.
- Prajapati JP, Upadhyay KG, Desai HK. Study on influence of post-production heat treatment on quality of fresh shrikhand. *J Food Sci Technol-Mysore* 28:365–367, 1991.
- Rasic JL, Kurmann JA. *Yogurt*. Copenhagen: Technical Publishing House, 1978.
- Rasic JL, Kurmann JA. *Bifidobacteria and Their Role*. Basel: Birkhauser Verlag, 1983.

- Rasic JL, Kosikowski FV, Bozic Z. Nutrient yogurt from low lactose milk using a combined lactase-UF retentate procedure. *Milchwissenschaft* 47:32–35, 1992.
- Ray B. Sublethal injury, bacteriocins, and food microbiology. *ASM News* 59:285–291, 1993.
- Reinbold GW, Reddy MS. Sensitivity or resistance of dairy starter and associated microorganisms to selected antibiotics. *J Milk Food Technol* 37:517–521, 1974.
- Sarkar S, Dave JM, Sannabhadhi SS. Characterisation of isolates of lactic acid bacteria from market sample of misti dahi. *Indian J Dairy Sci* 45:33–36, 1992.
- Sarkar S, Kuila RK, Misra AK. Antimicrobial properties of srikhand. *Indian J Dairy Sci* 49:270–276, 1996a.
- Sarkar S, Kuila RK, Misra AK. Effect of incorporation of gelolan TMSB 253 (stabilizer cum preservative) and nisin on the microbiological quality of shrikhand. *Indian J Dairy Sci* 49:176–184, 1996b.
- Sato J, Omata Y, Kodama Y, Noda K. Applications of DEFT in the dairy industry. *J Jpn Soc Food Sci Technol* 33:117–124, 1986.
- Seitz EW, Sandine WE, Elliker PR, Day EA. Distribution of diacetyl reductase among bacteria. *J Dairy Sci* 46:186–189, 1963.
- Singer NS, Latella J, Yamamoto S. Reduced fat sour cream. US Patent 5096730:Mar 17, 1992.
- Singer NS, Pookote S, Hatchwell LC, Anderson G, Shazer AG, Booth BJ. Flavor delivery system for fat free foods. US Patent 5202146:Apr 13, 1993.
- Speck ML. Market outlook for acidophilus food products. *Cultured Dairy Prod J* 10:8, 1975.
- Srinivasan R, Sarkar S, Pramanik KK, Misra AK. Isolation and characterization of lactococcus species producing bacteriocins. *Indian J Dairy Sci* 48:596–602, 1995.
- Swithinbank H, Newman G. *Bacteriology of Milk*. London: John Murray, 1903.
- Takizawa S, Kojima S, Tamura S, Fujinaga S, Benno Y, Nakase T. The composition of the lactobacillus flora in kefir grains. *Syst Appl Microbiol* 21:121–127, 1998.
- Tamime AY, Marshall VME. Microbiology and technology of fermented milks. In: BA, Law ed. *Microbiology and Biochemistry of Cheese and Fermented Milk*. London: Chapman & Hall, 1997, pp 57–152.
- Tamime AY, Robinson RK. *Yogurt Science and Technology*. New York: Pergamon Press, 1985.
- Tamime AY, Robinson RK. Fermented milks and their future trends. Part II. Technological aspects. *J Dairy Res* 55:281–307, 1988.
- Tamime AY, Muir DD, Wszolek M. Kefir, koumiss and kishk. *Dairy Ind Int* 64:(5)32–33, 1999.
- Valladao M, Sandine WE. Quaternary ammonium compounds in milk: Detection by reverse-phase high performance liquid chromatography and their effect on starter growth. *J Dairy Sci* 77:1509–1514, 1994.
- Vedamuthu ER. What is wrong with cultured buttermilk today? *Dairy Food Sanit* 5:8–13, 1985.
- Vedamuthu ER. The yogurt story—past, present and future. *Dairy Food Environ Sanit* 11:202–203, 265–267, 310–311, 371–374, 444–446, 513–514, 583–585, 729–733, 12:220–221, 351–354, 1992.

- Vedamuthu ER. The dairy leuconostoc: use in dairy products. *J Dairy Sci* 77:2725–2737, 1994.
- Vedamuthu ER, Shah RB. Method for the preparation of naturally thickened and stabilized fermented milk products and products produced thereby. US Patent 4328097:May 3, 1983.
- Wilkins DW, Schmidt RH, Shireman RB, Smith KL, Jezeski JJ. Evaluating acetaldehyde synthesis from L-[¹⁴C(U)] threonine by *Streptococcus thermophilus* and *Lactobacillus bulgaricus*. *J Dairy Sci* 69:1219–1224, 1986.
- Wood BJB, Holzapfel WH. *The Genera of Lactic Acid Bacteria*. New York: Chapman & Hall, 1995.
- Yalpani M. Polyhydroxyalkanoate flavor delivery system. US Patent 5225227:Jul 6, 1993.

10

Probiotics and Prebiotics

Stanley E. Gilliland

*Oklahoma State University
Stillwater, Oklahoma*

I. INTRODUCTION

Metchnikoff (1908) theorized that *Lactobacillus delbrueckii* subsp. *bulgaricus* could grow in the intestinal tract of humans and displace any putrefying bacteria that are present. Displacement of this group of bacteria was thought to reduce production of toxic compounds that adversely affect the human body, thus enabling humans to live longer. Research done since Metchnikoff's period has shown that *Lb. delbrueckii* subsp. *bulgaricus* neither survives nor establishes itself in the gastrointestinal tract. However, other species of lactobacilli have been reported to provide some beneficial effects through growth and action in the gastrointestinal tract. This group of bacteria and others are now often referred to as probiotics. Although there are other possibilities, cultures most often mentioned as probiotics for humans include *Lb. acidophilus*, *Lb. casei*, and *Bifidobacterium* species. These species along with *Propionibacterium* species and *Lb. reuteri* are the ones most often considered for use as probiotics for livestock. All these species can survive and grow in the intestinal tract, and thus have the potential to provide benefits. Certain yeast cultures also are considered as being probiotics for livestock even though the yeasts are not expected to survive and grow in the gastrointestinal tract.

Bacteria normally used as starter cultures for some fermented milk products, such as *Lb. delbrueckii* subsp. *bulgaricus* and *Streptococcus thermophilus* used to manufacture yogurt, also may provide benefits, but not through the ability to survive and grow in the intestinal tract. Benefits they provide come primarily from serving as a source of enzymes needed to improve digestion of nutrients

in the gut. For example, β -galactosidase is needed for hydrolysis of lactose in the small intestine (Gilliland and Kim, 1983).

Whereas some reports indicate that the nutritional value of milk can be improved by certain fermentations (Hargrove and Alford, 1980), this chapter focuses on the potential help or nutritional benefits that result from growth or action of probiotic microorganisms following their ingestion. Several benefits are possible from such microorganisms, including control of intestinal infections, control of serum cholesterol levels, beneficial influences on the immune system, improvement of lactose utilization in persons who are classified as being lactose maldigestors, and anticarcinogenic action. Research is continuing in each of these areas to provide definite scientific evidence that could permit specific health claims to be made for dairy products containing one or more of this group of probiotic organisms. Several publications have focused on these in more detail (Gilliland, 1990; Lee and Salminen, 1995; Sissons, 1989). Foods containing such microorganisms may be promoted as functional foods in the future.

II. POTENTIAL BENEFITS

Most of the potential benefits to be discussed will focus on those applicable to human health or nutrition. A separate section addresses the issue of probiotics for livestock use.

A. Control of Growth of Undesirable Organisms in the Intestinal Tract

Lb. acidophilus, *Lb. casei*, and species of *Bifidobacterium* can inhibit growth of undesirable microorganisms that might be encountered in the gastrointestinal tract. Most of the older reports dealing with this type of control focused on a therapeutic approach; in that cultured products made with these organisms were used to treat infections of various types (Gordon et al., 1957; Winkelstein, 1955). Some studies involving these organisms were poorly done and improper controls were used, so it is difficult to draw definite conclusions concerning the benefit of probiotic organisms. The newer approach is to provide consumers with products containing the probiotic organisms for use as preventive treatment in controlling intestinal infections. Studies using chickens as animal models and in which the birds were dosed with specific intestinal pathogens following consumption of cells of *Lb. acidophilus* have shown that the lactobacilli do exert control over *Salmonella* infections (Watkins and Miller, 1983). Feeding lactobacilli to birds before challenge with pathogens followed by continued consumption of *Lb. acidophilus* after the challenge dose resulted in best control of pathogens, sug-

gesting that continuous consumption of the probiotic organism is desirable. Researchers conducting this study also showed that *Lb. acidophilus* was effective in controlling *Escherichia coli* in the intestinal tract of chickens (Watkins et al., 1982).

In recent years, several other studies have shown the efficacy of certain probiotic organisms in controlling growth of undesirable microorganisms in the intestinal tract. A product containing a selected culture of lactobacilli and developed and marketed in Argentina has been useful in controlling intestinal infections (Oliver et al., 1999). Consumption of milk fermented with *Lb. casei* significantly decreased the severity of diarrhea in children in day care centers in France (Pedone et al., 1999). Consumption of cells of *Lb. acidophilus* controlled small bowel overgrowth in patients with kidney failure (Simenhoff et al., 1996). Ingestion of cells of *Bi. bifidum* reduced shedding of rotavirus (Duffy et al., 1994). Selected strains of *Lb. acidophilus* excreted an antimicrobial substance active against *Helicobacter pylori* both in vivo and in vitro (Coconnier et al., 1998).

Just how the probiotic bacteria function in inhibiting growth of undesirable microorganisms in the intestinal tract is not clear. Many of the probiotic organisms produce substances that are inhibitory in vitro; however, it is difficult to confirm the activity of these compounds in vivo. The probiotic bacteria in question all produce large amounts of acid during their growth, because they rely on fermentation to obtain energy for growth. However, the antagonistic action that they produce toward undesirable microorganisms apparently is not caused just by acid produced during their growth. Several of these organisms produce antibiotic-like substances, some of which have been classified as bacteriocins, which may be involved in the antagonistic action toward these pathogens. Bacteriocins, according to the classic definition, are bacterial proteins active against organisms closely related to the producer organism (Tagg et al., 1976). This may limit the breadth of action of these inhibitory substances produced by probiotic bacteria. They would not be expected to have any effect on gram-negative intestinal pathogens. Furthermore, because of their sensitivity to proteolytic enzymes, bacteriocins may not survive the digestive function of the intestines.

Antimicrobial substances, other than bacteriocins, produced by probiotic bacteria have been implicated in recent publications as having a possible role in controlling intestinal pathogens. A low molecular weight nonproteinaceous material produced by a *Lactobacillus* culture was active against a broad range of gram-negative and gram-positive bacteria (Silva et al., 1987). These researchers suggested the inhibitory agent to be a short-chain fatty acid other than lactic or acetic. Reuterin, an antimicrobial agent produced by *Lb. reuterii*, has a broad spectrum of activity. It has been characterized as a mixture of various forms of β -hydroxypropionaldehyde (Talarico and Dobrogosz, 1989). It also could be active in the control of pathogens.

Competitive exclusion by probiotic bacteria is another mechanism that has been suggested as being important in controlling intestinal infections (Watkins and Miller, 1983). Competitive exclusion involves the ability of lactobacilli or bifidobacteria to occupy binding sites on the intestinal wall, thereby preventing attachment and growth of enteric pathogens.

Definitive scientific data showing the mechanism of action whereby these probiotic bacteria may exert inhibitory actions toward pathogens in the intestinal tract would make it easier to select the most effective strains of probiotic bacteria for use in dairy products to help control intestinal infections in humans. Most likely the antagonistic actions produced by probiotic bacteria toward intestinal pathogens result from a combination of factors.

B. Improvement of Immune Response

Enhancement of the body's immune response by consuming cells of certain lactobacilli increases resistance of the host to intestinal infections (Lessard and Brisson, 1987; Perdigon et al., 1990a; Sato et al., 1988; Romond et al., 1997). Of the lactobacilli, *Lb. casei* seems to be the primary one involved (Perdigon et al., 1990B). *Bi. longum* also can stimulate the immune system to control *E. coli* in the gastrointestinal tract (Romond et al., 1997). As with other characteristics of the lactic acid bacteria, the relative ability of probiotic bacteria to cause such an effect probably varies tremendously among strains of individual species. Researchers in this area have suggested that this action involves activation of macrophages which in turn destroy pathogenic organisms in the body. It also has been suggested that consumption of these organisms is followed by secretion of components into the intestinal tract which are inhibitory toward certain of the foodborne pathogens. This enhancement of the immune system increases the host defense mechanisms and could be very important for control of foodborne illnesses. This may be a key explanation as to how certain probiotic microorganisms used as dietary adjuncts can exert control over intestinal infections.

C. Improvement of Lactose Digestion

People who lack the ability to digest lactose adequately are classified as lactose maldigestors. (In the past, terms such as 'lactose intolerance' or 'lactose malabsorption' have been used to describe this condition). The problem results from inadequate levels of β -galactosidase in the small intestine to hydrolyze ingested lactose adequately. Once a lactose maldigestor consumes sufficient lactose, it passes into the large intestine where it undergoes an uncontrolled fermentation that results in symptoms of cramps, flatulence, and diarrhea. These symptoms often follow consumption of milk by such individuals. Because lactose maldiges-

tion results from inadequate levels of an enzyme to hydrolyze lactose in the small intestine, the possibility exists for providing such an enzyme via the diet. Inclusion of a purified enzyme such as β -galactosidase in the diet is rather expensive and survival of the enzyme during passage through the stomach likely would be minimal. Research has shown that the presence of viable starter cultures in yogurt can be beneficial to lactose maldigestors (Gilliland and Kim, 1984; Kolars et al., 1984). This beneficial action results from presence of β -galactosidase in the bacterial cells. Apparently being inside the bacterial cells protects the enzyme during passage through the stomach so that it is present and active when yogurt reaches the small intestine. Once the yogurt culture reaches the small intestine, it interacts with bile, which increases permeability of the cells of these bacteria and enables the substrate to enter and be hydrolyzed (Noh and Gilliland, 1992). The enzyme remains inside the cell upon exposure to bile rather than leaking out into the surrounding medium. As mentioned previously, the starter cultures used for yogurt manufacture (*Lb. delbrueckii* subsp. *bulgaricus* and *S. thermophilus*) are not bile resistant and thus are not expected to survive and grow in the intestinal tract. Despite this limitation, consumption of these bacteria provides a means of transferring β -galactosidase into the small intestine where it can improve lactose utilization in lactose maldigestors.

Nonfermented milk containing cells of *Lb. acidophilus* also can be beneficial for lactose maldigestors (Kim and Gilliland, 1983). This organism, unlike the yogurt starter cultures, can survive and grow in the intestinal tract. However, a similar mechanism in improving lactose utilization in lactose maldigestors to that observed for yogurt bacteria is probably involved. β -Galactosidase activity of cells of *Lb. acidophilus* is greatly increased in the presence of bile because of increased cellular permeability (Noh and Gilliland, 1993). As with yogurt cultures, cells of *Lb. acidophilus* do not lyse in the presence of bile, but their permeability is increased permitting lactose to enter the cells and be hydrolyzed. Because *Lb. acidophilus* can survive and grow in the intestinal tract, it is reasonable to expect, however, that additional β -galactosidase may be formed after ingestion of milk containing this organism.

There has been some controversy over whether or not acidophilus milk is effective in improving lactose utilization by lactose maldigestors; however, if the cells contain sufficient levels of β -galactosidase before ingestion, it is reasonable to assume they will provide such a benefit. Results of studies that have suggested milk containing *Lb. acidophilus* is ineffective (Payne et al., 1981; Saviano et al., 1984) in improving lactose digestion might be questioned, because no evidence was provided concerning cultures used or the procedure by which they were produced. In those studies, it is possible, that insufficient β -galactosidase was present in milk containing cells of *Lb. acidophilus* at the time of consumption. One of the studies (Saviano et al., 1984) indicated that no β -galactosidase activity was detected in milk containing *Lb. acidophilus*.

Based on the proposed mechanism for improving lactose digestion by yogurt cultures, it seems reasonable that consumption of any product containing bacterial cells having adequate intracellular β -galactosidase activity could provide a benefit such as improving lactose utilization. Because this enzyme usually is inducible in most microorganisms, it is important that before ingestion the organism be grown in a medium containing lactose. This becomes particularly important when cells of probiotic bacteria grown in some medium other than milk are added to nonfermented milk. The level of β -galactosidase activity also varies among strains of *Lb. acidophilus* as well as among commercial yogurt cultures. Therefore, it is important to consider the level of β -galactosidase activity in probiotic or starter cultures to be used for improving lactose digestion in lactose maldigestors. It also is important for the activity to remain high during transportation and storage of such products so that the consumer receives the product containing enough of the enzyme to provide a benefit.

D. Anticarcinogenic Actions

Anticarcinogenic or antimutagenic activities have been reported for several cultures used to manufacture various fermented milk products (Goldin and Gorbach, 1984; Oda et al., 1983; Reddy et al., 1983; Shahani et al., 1983). Some of these studies have involved products containing probiotic bacteria expected to survive and grow in the intestinal tract, whereas others have involved only bacteria used to manufacture the product and which are not normally expected to survive and grow in the intestinal tract. For instance, consumption of yogurt by mice inhibited development of certain tumors (Reddy et al., 1983). This represents another potential health benefit for a cultured product without necessarily involving one of the traditional probiotic bacteria. In other studies involving human subjects, a culture of lactobacilli exhibited potential in controlling cancer of the colon (Goldin and Gorbach, 1984). The lactobacillus used in this study was later identified as *Lb. casei*.

Lb. acidophilus, *Lb. casei*, and *Lb. delbrueckii* subsp. *bulgaricus* are species most often mentioned as having potential to provide anticarcinogenic actions. For *Lb. delbrueckii* subsp. *bulgaricus*, which is not normally considered a probiotic organism, the anticarcinogenic action apparently is associated with substances produced by the organism during manufacture of yogurt as opposed to being produced in the body following consumption of yogurt. However, for *Lb. acidophilus* and *Lb. casei* growth or action in the gastrointestinal tract seems to be important. Part of the benefit may involve direct effects in inhibiting tumor formation. However, the main effect may result indirectly through inhibiting growth of undesirable bacteria that form carcinogens in the large intestine (Goldin and Gorbach, 1984). Thus, this may represent another benefit in being able to control growth of undesirable organisms in the gastrointestinal tract.

E. Control of Serum Cholesterol

In the 1970s, two studies were published that suggested organisms such as *Lb. acidophilus* can potentially reduce serum cholesterol levels in humans. One of these studies involved milk fermented with what was described as a “wild” strain of lactobacillus and then fed to a group of men on a high-cholesterol diet (Mann and Sperry, 1974). The study was designed to evaluate the influence of a surfactant (Tween 20) on serum cholesterol levels. The researchers theorized that the surfactant would increase absorption of cholesterol from the intestine and thus increase serum cholesterol levels. However, the serum cholesterol level in both groups of men, that is, those receiving the surfactant and those who did not, decreased! This was one of the first studies that suggested consumption of a fermented dairy product could reduce serum cholesterol levels in humans. However, neither the organism involved in the fermentation nor the mechanism was identified. In another study, cells of *Lb. acidophilus* added to infant formula reduced serum cholesterol in infants receiving the formula (Harrison and Peat, 1975), whereas infants receiving the formula without cells of *Lb. acidophilus* exhibited increased serum cholesterol levels. The researchers concluded that *Lb. acidophilus*, through its growth in the intestine, in some way influenced the serum cholesterol level, although no mechanism was suggested.

Several studies have shown that animals consuming milk containing cells of *Lb. acidophilus* had lower serum cholesterol levels than did animals that did not receive milk containing the lactobacilli (Danielson et al., 1989; Gilliland et al., 1985; Grunewald, 1982). Some strains of *Lb. acidophilus* can actively assimilate or take up cholesterol during growth in laboratory media (Gilliland et al., 1985; Gopal et al., 1996). This occurs when the organisms are grown anaerobically in the presence of bile. A portion of the cholesterol is incorporated into the cellular membrane of *Lb. acidophilus* (Noh et al., 1997). There is variation among strains of this organism in their ability to exert control over serum cholesterol levels (Gilliland et al., 1985). Pigs on a high-cholesterol diet fed a strain of *Lb. acidophilus* that actively assimilated cholesterol during growth in laboratory media had significantly lower serum cholesterol levels than did pigs receiving a strain of *Lb. acidophilus* that did not actively assimilate cholesterol in laboratory media (Gilliland et al., 1985). This suggests the ability to assimilate cholesterol in laboratory media provides an indication of the potential of this organism, if consumed, to exert some control over serum cholesterol levels. Similar findings were noted when a mixture of *Lb. johnsonii* and *Lb. reuteri* was fed to pigs (du Toit et al., 1998).

Another activity of *Lb. acidophilus* that may be important is its ability to deconjugate bile acids. This provides yet another mechanism whereby ingested *Lb. acidophilus* might exert control of serum cholesterol levels. Deconjugation of bile acids by lactobacilli can occur in the small intestine. *Lb. acidophilus* more

actively deconjugates glycocholic acid than it does taurocholic acid (Corzo and Gilliland, 1999). This becomes significant because the dominant conjugated bile acid in the human intestine is glycocholic acid. Free bile acids are less well absorbed in the small intestine than are conjugated bile acids and thus more are excreted through feces (Chickai et al., 1987). Excretion of bile acids through feces represents one of the major mechanisms whereby the body eliminates cholesterol. This is because cholesterol is a precursor for synthesis of bile acids and many bile acids that are excreted from the body are replaced by synthesis of new ones. Thus, there is a potential for reducing the cholesterol pool in the body. Furthermore, free bile acids do not support absorption of cholesterol from the intestinal tract as well as do conjugated ones (Eysen, 1973). Thus, deconjugation of bile acids in the intestinal tract may reduce the efficiency by which cholesterol is absorbed from the intestinal tract.

Research into the potential of *Lb. acidophilus* to exert hypocholesterolemic effects in humans has indicated tremendous variation among strains of *Lb. acidophilus* isolated from the human intestinal tract in their ability to assimilate cholesterol (Buck and Gilliland, 1994). Evaluation of strains of *Lb. acidophilus* used commercially in cultured or culture-containing dairy products in the United States has revealed that none is particularly active in assimilating cholesterol from laboratory media (Gilliland and Walker, 1990). On the other hand, new strains that are very active in this regard have been isolated from the human intestinal tract, and thus they may provide greater potential for use as dietary adjuncts to assist in controlling serum cholesterol levels (Buck and Gilliland, 1994). Of 122 isolates of *Lb. acidophilus* obtained from human intestinal sources, several were identified as having great potential for exerting control over serum cholesterol levels, because they were very active in assimilating cholesterol during growth in a laboratory medium. They were far more active in this regard than were the currently commercially available strains of *Lb. acidophilus*. One of these strains is presently used in the Netherlands to produce a fermented yogurt product named Fysiq which is promoted as being useful in helping maintain a healthy cholesterol level. This strain of *Lb. acidophilus* has been used in a human feeding trial of hypercholesterolemic individuals and caused a significant reduction in serum cholesterol levels (Anderson and Gilliland, 1999).

There may be other probiotic organisms that can help to control serum cholesterol levels. Some of these include *Lb. casei* (Brashears et al., 1998) and *Bifidobacterium* species (Gopal et al., 1996). *Bi. longum* removes cholesterol from laboratory media much the same as does *Lb. acidophilus* and incorporates part of it into the cellular membrane of this bacterium (Dambekodi and Gilliland, 1998). *Lb. casei* also can remove cholesterol from laboratory growth media. However, no evidence was found for association of cholesterol with the cellular membrane of this bacterium (Brashears et al., 1998). Both these organisms also can deconjugate bile acids. Currently there is great interest throughout the world in

the potential of these bacteria to exert some control over serum cholesterol levels in hypercholesterolemic individuals.

III. HEALTH CLAIMS

There is potential for probiotic cultures to provide health and nutritional benefits for consumers. However, data are insufficient in most instances to permit specific health claims to be made in the United States for dairy products containing such bacteria. Improvement of lactose utilization by lactose maldigestors is a possible exception. Before specific health claims can be made for most of these products, it is necessary for clinical trials to establish that the benefits indeed occur. Such trials should be conducted using only probiotic bacteria that have been selected for a specific activity. In other words, they should be selected in some manner to ensure they likely will produce the desired health or nutritional benefits (Gilliland, 1990).

In some European countries, products containing probiotics are marketed as providing certain health benefits. As an example, one in the Netherlands has been promoted as helping to maintain healthy cholesterol levels. Others have been promoted as helping to maintain desirable intestinal microflora. With recent approval to promote oat fiber and soy protein for specific health benefits in the United States, it may be possible in the future for other functional foods, such as those containing probiotics, to be marketed as providing certain health or nutritional benefits to consumers.

IV. CHARACTERISTICS NEEDED FOR PROBIOTIC CULTURES

It is unreasonable to expect one strain of any of the species of probiotic bacteria to provide all of the aforementioned potential health or nutritional benefits. In the past, most knowledge gained concerning variations among strains of lactic acid bacteria has focused on the ability of these organisms to produce desired organoleptic properties in cultured products and to do so as rapidly as possible. Very little, if any, attention has focused on potential health or nutritional benefits possible from these cultures. Most commercially available strains of probiotic bacteria have not been selected for any specific activity except perhaps to have their identity confirmed as being the indicated organism. To be successful as probiotic cultures, they must be selected for their ability to provide the targeted benefit for the consumer.

If cultured or culture-containing dairy products are to be useful as functional foods in providing health or nutritional benefits for consumers, it is ne-

cessary to alter the basis used for selecting commercial lactic acid bacteria. The cultures not only will have to be selected for their ability to produce desired organoleptic properties in the cultured product, but also will need to be evaluated for those factors related to potential health or nutritional benefits (Gilliland, 1989, 1990). Thus, the primary factor to be considered in this selection is that the culture(s) must be able to produce the desired benefit. Furthermore, the culture should retain that ability during production, manufacturing, distribution, and storage of the product before reaching the consumer. If the desirable action requires that the organism must grow in the intestinal tract, then characteristics that enable the organism to grow well under these conditions must be considered. To help ensure the ability of the organism to establish itself or grow in the intestine, it is important to consider the bile tolerance of the strain selected. Probiotic bacteria under consideration tend to be host specific (Fuller, 1973; Lin and Savage, 1984; Morishita et al., 1971). Therefore, it is necessary to consider the source of the organism. In other words, it is desirable to select the strain that is compatible with the host (i.e., humans) for which the product is intended.

In some instances, a product such as yogurt, which is made with the traditional yogurt culture, *Lb. delbrueckii* subsp. *bulgaricus* and *S. thermophilus*, also is supplemented with cells of *Lb. acidophilus* and/or *Bifidobacterium* species. If such a procedure is used to provide the consumer with the beneficial organisms, then care must be exercised to ensure that adequate numbers of probiotic organisms are present. Some probiotic cultures with the potential for providing health and nutritional benefits may not grow as well in milk during manufacture of fermented milk products as those that traditionally have been used for producing such products. Thus, research may be necessary to determine ways to improve growth of probiotic organisms in milk so that the consumer is provided with adequate numbers of these potentially beneficial bacteria.

To ensure any of the potential health or nutritional benefits that might be derived from probiotic cultures, it is necessary to test properly cultures and products containing them to be sure the consumer receives the product that is most likely to provide the intended benefit. If such products are to be designated as being functional foods and are to be effective, it is necessary to use properly selected probiotic cultures. This may result in the need for several types of milk products each containing a different selected strain(s) of the probiotic culture to provide the specific desired health or nutritional benefits.

V. PROBIOTICS FOR LIVESTOCK

Probiotics used for livestock often are referred to as direct-fed microbials. Their use is based on concepts which have been set forth during the past century for

potential benefits of lactic acid bacteria in humans. There is currently great interest in the use of probiotics by the livestock industry. A major reason for this interest is that probiotics offer a potential replacement for subtherapeutic levels of antibiotics in livestock diets. The microorganisms involved in this group of probiotics are the same species as used for humans plus yeast cells.

Much of the early research reported in evaluating probiotics for livestock was poorly done. Often the research reports did not provide information concerning the culture used, nor did they indicate the number of viable organisms in the product at the time of use. Furthermore, no basis was provided for having selected the particular organisms used. In the early marketing of such probiotic products for livestock, many products contained very low numbers, if any, of the organisms indicated on the product label (Gilliland, 1981).

As with humans, one strain of one species of a probiotic organism should not be expected to provide all of the possible benefits for all species of livestock. Even though the idea of using probiotics as livestock feed supplements is not new, there is much to be learned about the proper selection of strains of microbial species for use as probiotics to produce the desired effect. A mixture of bacterial species or strains may be required to yield such desired effects as improved growth and performance.

Much of the research which has been published concerning the potential of certain probiotic bacteria to control intestinal pathogens has been done using animal models. Thus, it is reasonable to expect that probiotics could function in helping control these undesirable bacteria in livestock. It is important to find means of controlling these intestinal pathogens in livestock, since they can find their way into the food supply at slaughter or through the use of waste or runoff water from livestock operations to fertilize fruits and vegetables.

There has been more research reported on the use of probiotics to control intestinal pathogens in poultry than in any other animal species. With germ-free chicks as an animal model, for example, it was demonstrated that *Lb. acidophilus* exerted control over *Salmonella* species and *Escherichia coli* in this animal (Watkins and Miller, 1983; Watkins et al., 1982). Using conventional chicks (1-day-old), successful use of *Lb. salivarius* to prevent colonization of chicks with *Salmonella* Enteritidis also has been shown (Pascual et al. 1999).

Some have suggested the use of a probiotic-like product made up of intestinal flora of healthy chickens to inoculate baby chicks. This has been named the competitive exclusion concept. It was accomplished by administering the mixed intestinal microorganisms from healthy adult chickens to newly hatched chicks (Nurmi et al., 1992). The idea behind this was that once established, the flora from healthy chickens could exclude infection by salmonellae. This approach is currently being advocated in the poultry industry in the United States. A problem associated with this approach, however, is the lack of control over composition of the mixed culture used to inoculate the chicks.

Perhaps the greatest interest in the livestock industry for the use of probiotics is to obtain improved growth and feed efficiency. This likely involves more than just control of undesirable microorganisms in the animal's digestive system. The mechanisms whereby such improvement could be obtained are presently unknown. Probiotics could provide some specific nutrients that enhance growth or increase appetite so the animal consumes more feed. Feeding of a probiotic product containing a mixture of four species of lactobacilli resulted in increased growth and improved the feed-to-gain ratio of broilers (Jin et al., 1998). Lactobacilli as feed supplements also improved feed intake and weight gain in lambs (Wallace and Newbold, 1993). Inclusion of viable yeast cells in animal feeds can provide a benefit in several livestock species; for example, both meat and milk production have thus been increased in cattle (Wallace and Newbold, 1993).

The stress of weaning young animals in most livestock species results in development of scours. Probiotics containing lactobacilli such as *Lb. acidophilus* can reduce or eliminate this problem in calves as well as in pigs and lambs (Johnson and Conway, 1992; Wallace and Newbold, 1993).

The possible mechanisms of action in livestock are probably similar to those reported for humans. Control of intestinal pathogens, for instance, could involve direct inhibitory action by the probiotic bacteria or could result from stimulation of the immune system. Improved growth and performance are more difficult to explain. Although it may be that this, in part, results from control of undesirable microorganisms, it is likely that it involves far more. Some microorganisms in a probiotic mixture could provide an enzyme in a manner similar to that involved in improvement of lactose digestion in humans. In a preliminary study in our laboratories, for instance, we have shown that a strain of *Lb. acidophilus* having a high level of amylase activity increased growth and feed efficiency in newly weaned pigs on a starch-based diet (unpublished data). Although several studies have noted improvement in growth and performance of livestock given various probiotics, we need to determine the mechanism whereby this improvement occurs. Then we will be better able to select appropriate probiotic organisms for use in livestock feeds.

VI. PREBIOTICS

Food (or feed) ingredients that are not digestible by humans (or livestock) that might provide benefit to the consumer by stimulating growth or activity of bacteria in the gastrointestinal tract are considered to be potential prebiotics. The large intestine is the most often considered sight of action for these substances, although they could have some impact on microorganisms in the small intestine.

For the most part, these prebiotic compounds contain oligosaccharides, which are not normally digested in the gastrointestinal tract except by resident

bacteria (Fooks et al., 1999). Theoretically, any dietary component reaching the large intestine undigested could be a potential prebiotic. However, oligosaccharides are most often considered and have received most attention as prebiotics. Oligosaccharides that have been considered as prebiotics include fructo-oligosaccharides, gluco-oligosaccharides, galacto-oligosaccharides, transgalacto-oligosaccharides, isomalto-oligosaccharides, xylo-oligosaccharides, and soybean oligosaccharides. Inulin-type fructo-oligosaccharides have been the ones most investigated as prebiotics. Much of the focus has been on their ability to enhance growth of *Bifidobacterium* species. These bacteria can hydrolyze such oligosaccharides and use them as an energy source to support their growth. They use them in preference to other complex carbohydrates such as starch. Fermentation of these soluble fibers in the large intestine results in production of short-chain fatty acids (primarily acetic, propionic, and butyric) (Flock and Moussa, 1998). These fatty acids are important to the host in lipid metabolism.

Inulin is extracted from chicory roots with hot water. Partial hydrolysis of this extract yields fructo-oligosaccharides, sometimes referred to as fructans (Roberfroid et al., 1997). These fructans are considered bifidogenic and increase growth of *Bifidobacterium* species in the intestinal tract, primarily in the large intestine. Galacto-oligosaccharides have a similar effect (Sako et al., 1999). Enhancing growth of this group of beneficial bacteria should improve their ability to exert an antagonistic action toward undesirable intestinal microorganisms such as pathogens. This should result in reduced shedding of intestinal pathogens by both humans and livestock when prebiotics are included in the diet.

Fructo-oligosaccharides in animal diets reportedly decrease the amount of fecal putrefactive compounds released, which implies an alteration in the intestinal microflora (Farnworth, 1993). This may be important in control of odors from livestock wastes.

Prebiotics, particularly oligosaccharides, apparently can be used alone to modify the intestinal flora, particularly in the large intestine. Since prebiotics tend to enhance growth of *Bifidobacterium* species in the intestine, a product containing a prebiotic and a selected strain of *Bifidobacterium* species could enhance beneficial effects for the host. This might improve the control of intestinal pathogens or bacteria that create malodors in livestock waste.

REFERENCES

- Anderson JW, Gilliland SE. Effect of fermented milk (yogurt) containing *Lactobacillus acidophilus* L1 on serum cholesterol in hypercholesterolemic humans. *J Am Coll Nutr* 18:43, 1999.
- Brashears MM, Gilliland SE, Buck LM. Bile salt deconjugation and cholesterol removal from media by *Lactobacillus casei*. *J Dairy Sci* 81:2103, 1998.

- Buck LM, Gilliland SE. Comparisons of freshly isolated strains of *Lactobacillus acidophilus* of human intestinal origin for ability to assimilate cholesterol during growth. *J Dairy Sci* 77:2925, 1994.
- Chickai T, Nakao H, Uchida K. Deconjugation of bile acids by human intestinal bacteria implanted in germ-free rats. *Lipids* 22:669, 1987.
- Coconnier MH, Lievin V, Hemery E, Servin AL. Antagonistic activity against *Helicobacter* infection in vitro and in vivo by the human *Lactobacillus acidophilus* strain LB. *Appl Environ Microbiol* 64:4573, 1998.
- Corzo G, Gilliland SE. Bile salt hydrolase activity of three strains of *Lactobacillus acidophilus*. *J Dairy Sci* 82:472, 1999.
- Dambekodi PC, Gilliland SE. Incorporation of cholesterol into the cellular membrane of *Bifidobacterium longum*. *J Dairy Sci* 81:1818, 1998.
- Danielson AD, Peo ER Jr, Shahani KM, Lewis AJ, Whalen PJ, Amer AM. Anti-cholesteremic property of *Lactobacillus acidophilus* yogurt fed to mature boars. *J Anim Sci* 67:966, 1989.
- Duffy LC, Zielezny MA, Talty MR, Dryja D, Altaie SS, Griffiths E, Ruffin D, Barrett H, Ogra PL. Reduction of virus shedding by *B. bifidum* in experimentally induced MRV infection. *Dig Dis Sci* 39:2334, 1994.
- duToit M, Franz CMAP, Dicks LMT, Schillinger U, Haberer P, Warlies B, Ahrens F, Holzapfel WH. Characterization and selection of probiotic lactobacilli for a preliminary minipig feeding trial and their effect on serum cholesterol levels, faeces pH and faeces moisture content. *Int J Food Microbiol* 40:93, 1998.
- Eyssen H. Role of the gut microflora in metabolism of lipids and sterols. *Proc Nutr Soc* 32:59, 1973.
- Farnworth ER. Fructans in human and animal diets. In: Suzuki M, Chatterton NJ, eds. *Science and Technology of Fructans*. Boca Raton, FL: CRC Press, 1993, p 257.
- Flock MH, Moussa K. Probiotics and dietary fiber. *J Clin Gastroenterol* 27:99, 1998.
- Fooks LJ, Fuller R, Gibson GR. Prebiotics, probiotics and human gut microbiology. *Int Dairy J* 9:53, 1999.
- Fuller R. Ecological studies of the *Lactobacillus* flora associated with the crop epithelium of the fowl. *J Appl Bacteriol* 36:131–139, 1973.
- Gilliland, SE. Enumeration and identification of lactobacilli in feed supplements marketed as sources of *Lactobacillus acidophilus*. *Okla Agr Exp Sta Res Rep MP-112:263*, 1981.
- Gilliland SE. Acidophilus milk products: a review of potential benefits to consumers. *J Dairy Sci* 72:2483, 1989.
- Gilliland SE. Health and nutritional benefits from lactic acid bacteria. *FEMS Microbiol Rev* 87:175, 1990.
- Gilliland SE, Kim HS. Effects of viable starter culture bacteria in yogurt on lactose utilization in humans. *J Dairy Sci* 67:1, 1984.
- Gilliland SE, Nelson CR, Maxwell C. Assimilation of cholesterol by *Lactobacillus acidophilus*. *Appl Environ Microbiol* 59:377, 1985.
- Gilliland SE, Walker DK. Factors to consider when selecting a culture of *Lactobacillus acidophilus* as a dietary adjunct to produce a hypocholesterolemic effect in humans. *J Dairy Sci* 73:905, 1990.

- Goldin BR, Gorbach SL. Alterations of the intestinal microflora by diet, oral antibiotics, and *Lactobacillus*: decreased production of free amines from aromatic nitro compounds, azo dyes, and glucuronides. *J Nat Cancer Inst* 73:689, 1984.
- Gopal A, Shah NP, Roginski H. Bile tolerance, taurocholate deconjugation and cholesterol removal by *Lactobacillus acidophilus* and *Bifidobacterium* spp. *Milchwissenschaft* 51:619, 1996.
- Gordon D, Macrae J, Wheeler DM. A lactobacillus preparation for use with antibiotics. *Lancet* 272:889, 1957.
- Grunewald KK. Serum cholesterol levels in rats fed skim milk fermented with *Lactobacillus acidophilus*. *J Food Sci* 47:2078, 1982.
- Hargrove RE, Alford JA. Growth response of weanling rats to heated, aged, fractionated, and chemically treated yogurts. *J Dairy Sci* 63:1065, 1980.
- Harrison VC, Peat G. Serum cholesterol and bowel flora in the newborn. *Am J Clin Nutr* 28:1351, 1975.
- Jin LZ, Ho YW, Abdullah N, Jalaludin S. Growth performance, intestinal microbial populations, and serum cholesterol of broilers fed diets containing *Lactobacillus* cultures. *Poultry Sci* 77:1259, 1998.
- Jonsron E, Conway P. Probiotics for pigs. In: Fuller R, ed. *Probiotics The Scientific Basis*. London: Chapman & Hall, 1992, p 259.
- Kim HS, Gilliland SE. *Lactobacillus acidophilus* as a dietary adjunct for milk to aid lactose digestion in humans. *J Dairy Sci* 66:959, 1983.
- Kolars JC, Levitt MD, Aouji M, Saviano DA. Yogurt—an autodigesting source of lactose. *N Engl J Med* 310:1, 1984.
- Lee YK, Salminen S. The coming of age of probiotics. *Trends Food Sci Technol* 6:241–245, 1995.
- Lessard M, Brisson GJ. Effects of *Lactobacillus* fermentation product on growth, immune response and fecal enzyme activity in weaned pigs. *Can J Anim Sci* 67:509, 1987.
- Lin JHC, Savage DC. Host specificity of the colonization of murine gastric epithelium by lactobacillus. *FEMS Microbiol Lett* 24:67–71, 1984.
- Morishita YT, Mitsuoka T, Kaneuchi CC, Yamamoto S, Ogota M. Specific establishment of lactobacilli in the digestive tract of germ-free chicks. *Jpn J Microbiol* 15:531–538, 1971.
- Mann GV, Spoerry A. Studies of a surfactant and cholesteremia in the Maasai. *Am J Clin Nutr* 27:464, 1974.
- Metchnikoff E. *The Prolongation of Life Optimistic Studies*. New York: Putnam's, 1908.
- Noh DO, Gilliland SE. Influence of bile on cellular integrity and β -galactosidase of *Lactobacillus acidophilus*. *J Dairy Sci* 76:1253, 1993.
- Noh DO, Gilliland SE. Influence of bile on β -galactosidase activity of component species of yogurt starter cultures. *J Dairy Sci* 77:3532, 1994.
- Noh DO, Kim SH, Gilliland SE. Incorporation of cholesterol into the cellular membrane of *Lactobacillus acidophilus* ATCC 43121. *J Dairy Sci* 80:3107, 1997.
- Nurmi E, Nuotio L, Schneitz C. The competitive exclusion concept: development and future. *Int J Food Microbiol.* 15:237, 1992.
- Oda M, Hasegawa H, Komatsu S, Kambe M, Tsuchiya F. Antitumor polysaccharide from *Lactobacillus* species. *Agric Biol Chem* 47:1623, 1983.

- Oliver G, Gonzalez S, Moreno R. Fermented milk for biotherapy. *Interciencia* 24:177, 1999.
- Pascual M, Hugas M, Badiola JI, Monfort JM, Garriga M. *Lactobacillus salivarius* CTC 2197 prevents *Salmonella enteritidis* colonization in chickens. *Appl Environ Microbiol.* 65:4981, 1999.
- Payne DL, Welch JD, Manion CV, Tsegaye A, Herd LD. Effectiveness of milk products in dietary management of lactose malabsorption. *Am J Clin Nutr* 34:2711, 1981.
- Pedone CA, Bernabeu AO, Postaire ER, Bouley CF, Reinert P. The effect of supplementation with milk fermented by *Lactobacillus casei* (strain DN-114 001) on acute diarrhea in children attending day care centers. *Int J Clin Pract* 53:179, 1999.
- Perdigon G, Alvarez S, Demacias MEN, Roux ME, Holgado APR. The oral administration of lactic acid bacteria increases the mucosal intestinal immunity in response to enteropathogens. *J Food Prot* 53:404, 1990a.
- Perdigon G, Demacias MEN, Alvarez S, Oliver G, Holgado A APR. Prevention of gastrointestinal infection using immunobiological methods with milk fermented with *Lactobacillus casei* and *Lactobacillus acidophilus*. *J Dairy Res* 57:255, 1990b.
- Reddy GV, Friend BA, Shahani KM, Farmer RE. Antitumor activity of yogurt components. *J Food Prot* 46:8, 1983.
- Roberfroid MB, VanLoo JAE, Gibson GR. The bifidogenic nature of chicory inulin and its hydrolysis products. *J Nutr Sci* 128:11, 1998.
- Romond MB, Haddou Z, Mielcareck C, Ramond C. Bifidobacteria and human health: regulatory effect of indigenous bifidobacteria on *Escherichia coli* intestinal colonization. *Anaerobe* 3:131, 1997.
- Sato K, Saito H, Tomioka H, Yokokura T. Enhancement of host resistance against *Listeria* infection by *Lactobacillus casei*: efficacy of cell wall preparation of *Lactobacillus casei*. *Microbiol Immunol* 32:1189, 1988.
- Sako T, Matsumoto K, Tanaka R. Recent progress on research and applications of non-digestible galacto-oligosaccharides. *Int Dairy J* 9:69, 1999.
- Saviano DO, El Ansuar AA, Smith DE, Levitt MD. Lactose malabsorption from yogurt, pasteurized yogurt, sweet acidophilus milk and cultured milk in lactose-deficient individuals. *Am J Clin Nutr* 40:1219, 1984.
- Shahani KM, Friend BA, Bailey PJ. Antitumor activity of fermented colostrum and milk. *J Food Prot* 46:385, 1983.
- Silva M, Jacobus NV, Deneke C, Gorbach SL. Antimicrobial substance from a human *Lactobacillus* strain. *Antimicrob Agents Chemother* 31:1231, 1987.
- Simenhoff ML, Dunn SR, Zollner GP, Fitzpatrick MED, Emery SM, Sandine WE, Ayres JW. Biomodulation of the toxic and nutritional effects of small bowel bacterial overgrowth in end-stage kidney disease using freeze-dried *Lactobacillus acidophilus*. *Miner Electrolyte Metab* 22:92, 1996.
- Sissons JW. Potential of probiotic organisms to prevent diarrhoea and promote digestion in farm animals—a review. *J Sci Food Agric* 49:1–13, 1989.
- Tagg JR, Dajani AS, Wannamaker LW. Bacteriocins of gram-positive bacteria. *Bacteriol Rev* 40:722, 1976.
- Talarico TL, Dobrogosz WJ. Chemical characterization of an antimicrobial substance produced by *Lactobacillus reuteri*. *Antimicrob Agents Chemother* 33:674, 1989.

- Wallace RJ, Newbold CJ. Probiotics for ruminants. In: Fuller R, ed. Probiotics The Scientific Basis. London: Chapman & Hall, 1993, p 317.
- Watkins BA, Miller BF. Competitive gut exclusion of avian pathogens by *Lactobacillus acidophilus* in gnotobiotic chicks. Poultry Sci 62:1772, 1983.
- Watkins BA, Miller BF, Neil DH. In vivo inhibitory effects of *Lactobacillus acidophilus* against pathogenic *Escherichia coli* in gnotobiotic chicks. Poultry Sci 61:1298, 1982.
- Winkelstein A. *Lactobacillus acidophilus* tablets in the therapy of various intestinal disorders: a preliminary report. Am Pract Digest Treatment 1:1637, 1955.

11

Cheese Products

Mark E. Johnson

*University of Wisconsin–Madison
Madison, Wisconsin*

I. INTRODUCTION

The origin of cheese is lost in antiquity. But, most assuredly, milk was contaminated with lactic acid bacteria, which through acidification of the milk, created conditions unfavorable for growth of other bacteria. As the story goes, milk held in storage vessels (animal stomachs) clotted, making cream cheese, the “mother of all cheeses.” The acid environment caused milk proteins to clot. It was a great leap forward when centuries later humans discovered the use of coagulating enzymes. This led to production of less sour cheeses. Natural contamination of milk or cheese by bacteria, yeasts, and molds led to development of a multitude of flavor sensations in cheese as it aged. Imagine, a long time ago, when humans first tasted that odorous morsel covered with colorful molds, yeasts, and bacteria. But now consider a world without Roquefort, Stilton, Limburger, or Gruyère. Boring! Unthinkable!

Modern cheese making is controlled and has been refined through strict adherence to manufacturing guidelines and careful selection of specific lactic acid bacteria and ripening microorganisms. Even so, sometimes there are problems. No cheese is produced in a sterile environment, so contamination is inevitable. One of the chief causes of poor flavor quality in cheese is the undesirable metabolism of contaminating microorganisms. A preventable cause of poor-quality flavor is that many retailers sell products long after they have reached the end of their expected shelf life. The ability of a cheese to age well with regard to undesirable microbial growth depends on cheese composition, manufacturing protocol, level of contamination, and ability of the contaminants to grow in cheese. There-

fore, cheese maker, retailer, and consumer must be aware of limitations of the product with regard to growth of contaminants and defects that they cause. It must be kept in mind that not all undesirable attributes of a cheese result from contaminating microorganisms. Some cheese defects may be caused by poor milk quality (late lactation milk, milk from mastitic animals high in enzymes of animal origin, i.e. lipase and protease), inappropriate rate of acid development by the starter, or poor manufacturing and storage regimens.

Although there are more than 1000 named varieties of cheeses worldwide, this chapter discusses only the major types.

II. DAIRY CHEMISTRY AND THE CHEESE-MAKING PROCESS

For many cheese makers, there is an art to making cheese. To cheese manufacturers, it is commonly a routine, strictly controlled process. No matter how it is made, cheese is a complex entity in a constant state of change, which has been likened to an ecological community of living organisms in which microbiological activities affect and are influenced by chemical changes.

Production of cheese involves two interconnected phases: The first is to develop the desired composition and pH, and the second is to develop desired physical and flavor characteristics. The first phase is controlled through milk composition and manufacturing protocol, particularly rate and extent of acid development by the starter during the manufacturing process. The second phase is influenced by the first but is dictated by metabolism of a variety of microorganisms and by enzymatic and chemical reactions. This process is called ripening, curing, or maturation, and depending on the cheese variety, may take many months to complete.

In concept, manufacture of cheese is simple. In reality, it is a complex process governed by a series of interrelated chemical and physical phenomena. During cheese making, a coagulum is formed in which milk proteins (caseins) are clotted, entrapping the milk fat, water, and water-soluble components. Further manipulations of the coagulum (cutting, heating, stirring) and development of acid result in controlled moisture expulsion and desired physical and chemical changes of caseins. The resulting curd and whey mixture is separated, with curd being formed into blocks, wheels, or other shapes.

Development of desired flavor, body, and texture is brought about through a combination of the activity of specific introduced microflora and enzymes as well as naturally occurring or contaminating bacteria and enzymes. Part of the initial maturation process involves physical changes to the protein brought about through a decrease in pH, loss of calcium, and hydration of casein. Without the ripening process, it would be impossible to distinguish one variety of cheese

from another except to note that different cheeses may have different physical characteristics.

Milk solids are composed of protein (casein and whey protein), milkfat, lactose, citric acid, and mineral salts (usually associated with the casein) collectively called ash. The composition of milk varies considerably between species and individual animals. It is affected by breed and genetics of the animal, feed, environmental conditions, lactation number, stage of lactation, and animal health. All of these factors can also influence cheese making and cheese characteristics. An average composition of cow milk is as follows: 87.6% water, 3.9% milk fat, 3.1% true protein (82% caseins, 18% whey proteins), 4.6% lactose, 0.7% ash (also see Chap. 1).

There are three basic ways to make cheese, but a given variety is made with only one method. All methods involve development of acid by a select group of lactic acid bacteria called the starter. All methods involve some means of concentrating the milk solids (mostly milkfat and protein) by expelling a portion of the aqueous phase of milk (serum or whey).

Rennet curd cheeses (most varieties) are made by clotting milk with a coagulating enzyme (all are proteolytic enzymes) such as chymosin (the most active ingredient in rennet). Acid curd cheeses (cottage, cream) are made with acidification of milk sufficient to cause casein to form a clot. Heat-precipitated curd cheeses (ricotta, queso blanco) are made with a combination of low pH and high heat to precipitate proteins (both casein and some whey proteins).

Fresh or nonripened cheeses such as cottage and mozzarella can be made by direct addition of acid (acetic, lactic, or citric). Cheeses made by this method are called direct acid cheeses (e.g., direct acid mozzarella).

A. Rennet Curd Cheese Manufacture

Rennet curd cheeses are those in which the coagulum is formed by activity of a coagulant, an enzyme mixture with particular proteolytic activity. Coagulants are commonly called rennets. Calf rennet is derived from an extract of calf stomachs, but there are other rennets derived from different sources: fungi, other animals, and some plants, especially thistles. All contain proteolytic enzymes, which, through their activity, help to destabilize casein micelles in milk, an event that subsequently transforms milk from a liquid to a semisolid (coagulum). Chymosin is the desired coagulating enzyme in calf rennet, but because of cost, demand, and the lack of calf stomachs, most chymosin used in the United States is produced by genetically engineered bacteria, yeasts, or molds. Fermentation-derived chymosin is highly purified (100% purity) and is used in liquid or tablet form. Chymosin is the preferred coagulant, because it has specificity toward one peptide bond in κ -casein. Although chymosin hydrolyzes bonds in casein molecules at other sites when they are accessible, the specific site of hydrolysis that occurs during coagu-

lation is Phe₁₀₅-Met₁₀₆. The nonspecific proteolytic activity of some other coagulants causes concern over excessive proteolysis, leading to a soft-bodied cheese, bitter flavor defects, and reduced cheese yield.

Caseins exist in complexes of discretely arranged molecules called micelles. There are four types of casein molecules, α_{s1} , α_{s2} , β , and κ -caseins. The exact molecular arrangement of molecules is not known, but it is hypothesized that micelles are composed of groups of casein molecules linked together through various types of bonding, including calcium phosphate bridges, and most importantly electrostatic and hydrophobic interactions. A hydrophilic (and negatively charged) portion of κ -casein molecules protrudes from the micelle surface, giving the micelle stability from spontaneous aggregation.

At the normal pH of milk (6.6–6.7), micelles carry a net negative charge because of the nonprotonated amino, carboxyl, and phosphate groups on caseins. Through electrostatic repulsion and steric hindrance via the “hairs” of κ -casein, micelles are stable (show no tendency to flocculate or gel) and remain as individual entities. Activity of the coagulant removes the protruding, hydrophilic region on the κ -casein molecule. This eliminates steric hindrance and reduces the negative charge at the micelle surface. With loss of these barriers, micelles begin to come together (clot formation). Ionic calcium (added as CaCl_2 or released from micelles through acidification of milk) allows adjacent micelles to aggregate through hydrophobic and electrostatic interactions. Eventually (20–30 min), casein micelles form a continuous network of aggregates called the clot or coagulum. Milkfat, water, and water-soluble components (serum) are entrapped within the casein network. Undenatured whey proteins are water soluble and do not participate in forming the network but are trapped in spaces (pores) that form between aggregates of micelles.

Once the desired firmness of the coagulum has been reached, it is cut into small cubes or pieces (curd). The firmer the coagulum when cut and the larger the curd particles, the higher the moisture content of cheese. After the coagulum is cut, casein molecules continue to interact and squeeze out serum trapped between them, and with exogenous pressure, curds shrink and become firmer. This process is called syneresis and is enhanced by lowering the pH, increasing the temperature of curd (cooking process), and stirring the curd. Therefore, the rate of acid development by the starter has a great influence over moisture content of cheese and control over the rate of acid development is key to successful cheese manufacture. Body (soft to firm) texture (grainy to smooth), melt, stretch, chewiness, oil release during baking, casein hydration, and color of cheese are directly controlled by pH. In addition, growth and metabolism of microorganisms and flavor development are strongly influenced by pH.

Each variety of cheese has a desired rate and extent of acid development, which if not met or compensated for, may result in too much or too little moisture

or too high or too low pH, creating undesirable physical and flavor characteristics in cheese. At the proper time, curd is separated from whey and treated appropriately as dictated by the variety of cheese. Curd may be continuously stirred as whey is being removed or it may be allowed to mat. Curd may be salted first and then formed into the desired shape or formed first and then salted by placing the cheese into brine. Pressing of blocks, cylinders, or wheels of cheese removes trapped whey from the cheese and helps individual curds to fuse, forming a solid mass of cheese. Not all cheeses require pressing. The unripened cheese is then ready for maturation. Camembert and surface-ripened cheeses (Limburger) will be inoculated with specific microorganisms at this time.

B. Acid Curd Cheeses

Acid curd cheeses do not rely on activity of a coagulating enzyme to clot milk. Instead, milk is acidified by direct addition of acid or through lactic acid developed by starter bacteria. At a pH of approximately 5.2, caseins in milk begin to flocculate and eventually gel as the pH decreases. Gelation is the consequence of acidification-induced physicochemical changes to caseins. At neutral pH, casein micelles remain as individual entities and are unable to interact or form aggregates. This is, in part, caused by charge repulsion (micelles are negatively charged). In addition, hydrophilic regions of κ -casein molecules protrude from the micelle core and prevent hydrophobic cores of adjacent micelles from interacting (stearic repulsion).

As the pH is lowered, the calcium-phosphate complex disintegrates and some casein molecules dissociate from micelles. There is also a reduction of the net negative charge on casein molecules, an increase in hydrophobic interactions, and it is thought that the protruding portion of casein molecules falls back onto the casein micelle core. The net result is that micelles and solubilized casein molecules begin to form aggregates, eventually leading to formation of a continuous network of aggregates and visible gel (pH \sim 4.95). In cottage cheese, the gel is cut into small cubes at a pH of 4.65–4.75. Serum (whey) is immediately expelled from the curd.

In cream cheese manufacture, the gel is stirred at pH 4.4–4.8 rather than cut as in cottage cheese, and whey is removed by centrifugation. Traditionally, clotted milk was put into bags of cheesecloth and hung to filter out serum. A low pH of cheese tends to produce a grainy or gritty product. Separated cheese is packaged (cold-pack cream cheese) or processed. Hot-pack cream cheese is made by blending cold-pack cream cheese with cream, whole milk, salt, stabilizers, and skim milk solids and heating the mixture to (72–74°C). The homogenized blend is packaged hot. Microbiologically induced defects are similar to those in cottage cheese but are less likely to occur, because the cheese is packaged hot.

C. Acid-Heat Coagulated Cheese

The premise for manufacture of acid-heat coagulated cheeses is to heat milk to 78–80°C and then acidify milk by direct addition of citric, acetic, or lactic acid to the desired pH (5.8–5.9 for ricotta, 5.2–5.3 for queso blanco). Milk for queso blanco can also be first acidified by lactic acid bacteria (*Lactococcus* spp.) and then heated. Heating of the milk (ricotta milk is usually a mixture of sweet whey, whey protein concentrate, and milk) causes coagulation and flocculation of caseins and whey proteins. In ricotta cheese manufacture, proteins and entrapped fat are removed or filtered from the remaining serum and drained until packaged. In queso blanco cheese manufacture, curds are allowed to settle and whey is drained. Curds are then salted and pressed. Both cheeses are consumed fresh, and because denatured whey protein forms a network with the casein, the cheeses resist melting during frying or baking. Because of the high-heat treatment under acidic conditions, survival of bacteria other than spore formers is minimal, but contamination during packaging is of concern. Microbiologically induced defects are comparable to those of cottage cheese. Most defects are caused by growth of *Pseudomonas* sp., yeasts, and molds.

III. INFLUENCES OF MICROBIOLOGICAL QUALITY AND MILK COMPOSITION ON CHEESE QUALITY

The microbiological quality and composition of milk play an integral part in the quality of the cheese made from it. Cheese can be made from grade A or grade B milk, but cottage, cream, and mozzarella cheeses must be made from grade A milk only. The bacterial count of grade A milk, as determined by a standard bacterial count or loop count, cannot exceed 100,000/mL at the time of receipt or collection. The bacterial count of grade B milk cannot exceed 300,000/mL (Wisconsin Administrative Code). Processors often pay premiums for low bacterial count milk as an enticement to farmers to produce high-quality milk. In practice, processors have recorded that milk from greater than 90% of producers has a bacterial count of less than 20,000/mL. The bacteria found in the milk arise from contamination (especially from air and biofilms on equipment) or from the animal itself (see Chap. 2).

The level of contamination is reflective of the cleanliness of the entire milking operation, including that of the animal before milking. Clostridia and lactic acid bacteria generally originate in silage and other feeds and are concentrated in feces. High levels of clostridia in silage indicate poor lactic acid fermentation (Stadhouders and Spoelstra, 1990). Feces can get on the udder, and if the udder is not cleaned, milk can become contaminated. Improper cooling rates or final holding temperatures of milk result in high numbers of bacteria reflective of an

environment conducive to microbial growth. Most bacteria in milk are, not surprisingly, psychrotrophic bacteria and they are the contaminants likely to grow at the low temperature at which milk must be stored (not to exceed 7°C for grade A and 10°C for grade B within 2 h after milking). *Pseudomonas* spp. are usually the dominant psychrotrophic organisms found in milk. Although these bacteria are easily killed by pasteurization, they produce lipases and proteases, which are not totally inactivated by this heat treatment (Griffiths et al., 1981). The enzymes are active in milk and can cause bitterness (protein hydrolysis) and rancidity (milk fat hydrolysis) in products made from milk if the level of activity is high enough (Cousin, 1982). Milk may be held for 2 days (legally) after receipt at the factory and microbial counts will undoubtedly increase. It is growth of *Pseudomonas* sp. during refrigerated milk storage that concerns the cheese maker.

A more important cause of rancidity in milk and cheese is activity of endemic animal lipases (milk lipase). The level of activity of this enzyme is increased in milk obtained from animals with mastitis (udder infection). In this instance, lipase activators and somatic cells are secreted from blood into milk. Somatic cells are used as an indicator of cow health and limits have been set by individual states (not to exceed 750,000/mL) (Wisconsin Administrative Code). Milk from mastitic animals has decreased casein content, the major protein found in milk, although the total amount of all proteins (whey proteins increase) may decrease only slightly, if at all (see Chap. 1).

The composition, quality, and amount of cheese produced are greatly affected by the casein content of milk. The other proteins, collectively called whey proteins, are water soluble and contribute much less to cheese yield. The lower the casein content of milk, the lower the yield of cheese. Cheese makers do not routinely directly measure casein in milk, because the test is expensive and takes too long to complete. Instead, they use fast, inexpensive, automated tests to measure total protein. Casein content is calculated by multiplying the percentage of total protein by 0.82. In mastitic milk, however, the amount of casein as a percentage of total protein decreases. Cheese makers cannot predict this value. Rather a high somatic cell count indicates that the casein content of milk may be reduced. Consequently, the cheese maker commonly pays premiums for low somatic cell count milk.

IV. MILK PRETREATMENT: CLARIFICATION, STANDARDIZATION, AND HEAT TREATMENT

All milk received by the cheese plant is first tested for the presence of antibiotics. Milk containing antibiotics must be dumped (liquid manure or landspread) even though, if diluted with other milk, a negative test could be obtained. Raw milk, as the cheese maker receives it, is almost universally filtered to remove extrane-

ous matter (straw, hay, and large clumps of bacteria). The Code of Federal Regulations establishes fat (milk fat content by weight of the cheese solids or fat in the dry matter [FDM]) and moisture limits for some cheeses. These values are called the standard of identity. The casein to milkfat ratio in milk determines the FDM of cheese, whereas moisture is controlled by the manufacturing process. The use of whole milk almost always results in cheese with an FDM of at least 50%. To manufacture cheeses with a lower FDM, such as part-skim mozzarella or Swiss cheese, milkfat is removed or skim milk is added to whole milk. The process of manipulating the composition of milk is called standardization and is becoming more popular for all cheese types because of economic considerations and a desire for uniformity of cheese composition and cheese yield.

A. Heat Treatment

Heat treatment given milk before cheese making varies from country to country, cheese maker to cheese maker, and cheese to cheese. Pasteurization of milk is a legal requirement in the United States for fresh cheeses such as cottage, mozzarella, and reduced-fat varieties. It is based on a 9-log destruction of *Coxiella burnetti*. Cheeses made from unpasteurized milk must be held for 60 days at a temperature not less than 1.7°C (Code of Federal Regulations, 1995). It is thought that pathogens will die out during this time period because of acidic conditions in cheese and growth of nonstarter lactic acid bacteria. However, this may not be true, especially if the level of contamination is high. Manufacturers who do not pasteurize milk use another heat treatment (65–70°C for 16–20 s), but the trend is toward pasteurization. A main argument against pasteurization is that cheeses made from pasteurized milk tend to have a milder flavor (the flavor takes longer to develop or the flavor is atypical of raw-milk cheese). Research into development of flavor in cheese may provide means to overcome this perceived obstacle, but the question of safety of raw-milk cheeses remains. Pasteurization is not a guarantee of safety, because milk or cheese can be contaminated after the milk has been pasteurized. When cases of illness can be attributed to consumption of cheese containing pathogens (a rare event), often the cheese is manufactured under poor hygienic conditions, is a fresh cheese, is made from unpasteurized milk, or the rate and extent of acid development were curtailed (Johnson et al., 1990a). The rate of acid development is critical (as well as contamination in the first place), since some bacteria, especially coliforms, will not grow well at low pH and higher acid cheeses. It is not uncommon to find coliform bacteria in washed curd cheese varieties (lower in acid content—baby Swiss, reduced-fat varieties) or in cheeses where the acid development was slow (especially because of phagic infection).

The effectiveness of pasteurization in killing bacteria in milk depends on initial microbial numbers, composition (fat and sugar), and thermoresistance of

individual microorganisms. The thermal death time of bacteria is logarithmic. This implies that within a given population of a single strain of microorganism, some individuals will survive pasteurization and other individuals will be killed. By definition, thermophilic microorganisms survive pasteurization, and by convention, thermophilic bacteria are classified as being thermophilic based on the potential for individual bacterial cells within a population to survive pasteurization. Genera containing thermophilic species include *Microbacterium*, *Micrococcus*, *Bacillus* spores, *Clostridium* spores, *Streptococcus*, *Coryneform*, *Enterococcus*, and *Lactobacillus*. Some of these bacteria are responsible for a variety of cheese defects (Hull et al., 1992), such as excessive softening of cheese, splits and cracks, off-flavors, and abnormal color. Thermophilic bacteria may colonize in the regenerative section of the pasteurizer. Indeed, a solution to keep numbers of thermophilic microorganisms low is to clean and sanitize the pasteurizer more often.

Although rarely used in the United States, a specially designed centrifuge called a Bactofuge (bactofugation) is used to remove most of the bacterial cells and spores (empirically 98%) from milk. Two streams of milk result from bactofugation, the "cleaned" milk and the bactofugate containing bacterial spores and cells. If used, the bactofugate is heated to 130°C for a few seconds, but the milk is pasteurized. The two fractions are then recombined. Bactofugation is used in Europe in lieu of sodium nitrate in controlling outgrowth of *Clostridium tyrobutyricum* spores, whose metabolism results in gassy, rancid cheese. The use of sodium nitrate in cheese is not permissible in the United States.

After heat treatment, milk is cooled to the temperature conducive for optimal starter activity and pumped into specially designed vessels called vats. Cheese vats vary in size, with the larger vats holding as much as 22,700 kg and the smaller commercial vats holding approximately 4500–6800 kg. Vats are generally double walled to permit controlled indirect heating of milk. If starter is used, it can be added while milk is being pumped into the cheese vat or after the vat is filled. The temperature of milk at the time starter is added is determined by the type of cheese to be made, type of starter, and the desired temperature at the time of coagulant addition, but it is generally between 31 and 34°C.

B. Starters

The strains and balance of strains of bacteria used in starters is often dictated by tradition as much as it is by manufacturing protocol and desired cheese characteristics. The choice of starter depends on the desired rate and extent of acid development (pH) during manufacture, proteolytic activity of the strains, flavor (and gas formation if desired), and conditions encountered during manufacture and storage such as pH, acidity, salt, and temperature profiles. Mesophiles are sometimes used

to manufacture mozzarella (non-pasta filata type) and Swiss varieties instead of the traditional thermophilic starters. In these instances, a lower cook temperature is used and the resultant cheese is generally higher in moisture and may have a slightly different flavor profile (more acid, less buttery). The amount of starter used is based on the rate of acid development desired by the manufacturer and is dictated by cheese variety, but it is influenced by strain and how the culture was propagated (conditions of growth such as media, pH control, and age). This is an important concept, because amounts of starter listed in literature for cheese manufacture can be misleading (e.g., use of 1% w/w starter grown with no pH control may be equivalent to using 0.2% w/w starter grown with pH control). Additional information about starter cultures is given in Chapters 6, 7, and 8. The use of artisanal cultures is not common in the United States. These cultures are mixtures (unknown composition) of several genera, species, and strains of lactic acid bacteria. They may contain lactococci, lactobacilli, leuconostocs, streptococci, and enterococci and probably give the cheese special flavor characteristics.

V. CHEESE MICROBIOLOGY

The diversity of cheese-manufacturing protocols, ripening regimens, and composition makes cheese a complex subject microbiologically. It is a misconception to think of cheese microflora in terms of the type of cheese; for example, all Cheddars, blue cheeses, and so on. Each individual cheese (not type) has its own unique microflora regardless of the starter or any deliberately added secondary ripening microorganisms (e.g., molds or yeasts). There is an extensive list of adventitious microorganisms that can grow in or on cheese, but their presence in any cheese is governed by chance. These nonstarter, nondeliberately added microbes are contaminants to milk or cheese. Thus, the contaminants that are found in any cheese result because the specific microbes happen to be in milk or on equipment, in air, or on humans that have had direct contact with the milk or cheese. It is extremely difficult to interpret data on microbial content of cheese because of chance contamination. In addition, the cheese environment plays a critical role in growth of microorganisms.

Microorganisms that grow in cheese or at least maintain viability follow the same set of criteria (pH, moisture, salt, acidity/type of acid, redox potential, nutrient availability, competition, temperature, anaerobic/aerobic conditions) as in any food product. Two factors determine the microflora of cheese: presence and survival of the microorganism and ability of the microorganism to grow.

During cheese maturation, environmental conditions can change sufficiently to allow growth of initially inhibited contaminants, or conditions may become even more inhospitable. The cheese environment is dynamic. Thus, the

microflora in cheese can be considered to be a dynamic ecological system. Few studies on bacterial viability in cheese have been completed in which changes in cheese chemistry during maturation are correlated with its effect on the microflora.

A complicating factor in the study of cheese microflora is methodology used to isolate microorganisms. Selective media may provide too harsh an environment for recovery and growth of injured or stressed cells. Microorganisms may be viable and metabolically active but not culturable with current methods. Nonselective media may not be appropriate to detect low numbers in a competitive environment.

Why is it important to study the microorganisms in cheese? Pathogens in cheese are of utmost importance. However, flavor quality (both desirable and undesirable) of cheese is also a consequence of the metabolism of microorganisms. Additionally, some textural defects can be directly attributed to growth and metabolism of microorganisms.

Molecular techniques are being applied selectively to determine the presence of individual species and strains of bacteria in cheese. The polymerase chain reaction (PCR) is a rapid procedure for *in vitro* enzymatic amplification of a defined segment of DNA (Atlas and Bej, 1994). It is particularly useful in identifying the proverbial needle in the haystack and individual strains of bacteria. A unique oligonucleotide sequence (probe) can be used specifically to identify (through amplification) the presence of DNA from particular bacteria in cheese. Enumeration of the bacteria is not necessary, but the bacteria may no longer be alive. DNA extracted from individual bacteria isolated using traditional techniques can also be tested to determine the exact species or strains of bacteria. Of particular interest is rapid detection of low levels of pathogens in milk and cheese (Herman et al., 1995). The technique has also been applied to identify species of *Clostridium* in cheese (Klijn, 1995), new strains of *Lactococcus lactis* subsp. *cremoris* (Salama et al., 1993), individual strains of *Lactobacillus helveticus* (Drake et al., 1996) and nonstarter lactobacilli in Cheddar cheese (Fitzsimmons et al. 1999).

Many of the adjuncts used to enhance flavor of cheese are *Lactobacillus* spp. and are often not easily differentiated from other strains of lactobacilli by biochemical tests. Complicating the situation is that lactobacilli are the dominant nonstarter lactic acid bacteria found in cheese. Selective media for lactobacilli cannot differentiate between adjunct and contaminant lactobacilli. This makes it difficult to determine numbers of individual strains of lactobacilli in mixed populations of lactobacilli. It is important to follow numbers of individual strains of lactobacilli (or other bacteria) to study the cause and effect of *Lactobacillus* spp. (or other bacteria) on flavor development in cheese. In addition, the ability unequivocally to determine the presence of patented or licensed strains of adjuncts can be useful for legal purposes.

A. Cottage Cheese

Cottage cheese curd is made from grade A pasteurized skim milk. Fortification of milk low in casein (<2.4% casein or <9% total milk solids) with very low heat-treated nonfat dry milk can improve cheese yield and quality (Emmons and Tuckey, 1967).

Milk is inoculated with *Lc. lactis* subsp. *lactis* and *cremoris*, with the latter being generally preferred. Commercially, cottage cheese is usually made with a “short set”; that is, 4–5 h elapse between time of starter addition (milk pH 6.60, 31–32°C) and time of cutting (coagulated milk pH 4.70–4.8). However, a “long-set” method is also used. To promote efficiency, the long-set method is sometimes used. Vats are filled with milk (20–22°C) and starter is added so that overnight (9–12 h) the pH of milk decreases to 4.90. Thus, when the cheese maker returns at the start of the workday, the milk coagulum is almost ready to cut. In the short-set method, the inoculation rate of the starter is 3–5% w/w of milk; whereas in the long-set method, much less (0.5–2% w/w) starter is used.

The pH at which curd is cut and the final pH of the curd after processing are critical for yield and cheese quality but vary among processing plants. This variability results from a variety of factors, including casein content of milk, heat treatment of milk, and rate of acid development by the starter. Overacidification or underacidification leads to brittle curd that shatters when stirred. Tiny pieces of curd may be lost in subsequent manufacturing steps, causing a loss in yield; or if retained, they may cause graininess (many hard bits of curd) and lack of uniform curd size (a visual defect that downgrades the product). Most manufacturers use a very small amount of coagulant. This enables curd to be cut at slightly higher pH. Curd is less fragile and yield is higher.

Once the coagulum is cut, the curd and whey mixture is heated to 54–57°C (in approximately 2 h) and held (15–20 min) until proper firmness is reached. Rate of heating and final temperature can prevent overacidification and firms curd (removes whey). Although strain dependent, most lactococci do not produce significant amounts of acid at temperatures above 40°C and are reduced in number by the cooking procedure (Collins, 1961). *Pseudomonas* spp. and Enterobacteriaceae, common spoilage bacteria of cottage cheese, are also sensitive to the cooking procedure, which greatly reduces their number. The lethality of the cooking procedure is time and temperature dependent and is determined by the initial bacterial load. Therefore, the lower the bacterial population at the time curd reaches the final cooking temperature, the more effective a given heat treatment is.

After correct curd firmness is reached, most whey is removed and curd is washed two or three times with cold water. The wash step removes lactic acid and lactose and helps to control the level of acidity (acidic taste) in the finished cheese. Water is acidified (pH 4.5–6.0) and chlorinated (5–10 ppm) or pasteur-

ized to kill bacteria. Washing cools curd rapidly to less than 5°C, which is essential to keep growth of contaminating bacteria to a minimum. After the last wash water is removed, pasteurized cold cream dressing is added and the product is packaged. The amount of fat in the cream dressing determines the fat content of the final cheese, so reduced-fat cottage cheese is made by adjusting the solids and fat content of the cream dressing.

Contaminated equipment and air are the most likely sources of spoilage bacteria in creamed cottage cheese. Although cottage cheese curd is acid (pH approximately 4.5–4.7), the pH of the final commercial product, creamed cottage cheese, is higher (5.0–5.3). The pH of the creamed cheese can be manipulated by the acidity of the cream dressing. Low product pH (5) may lead to free whey accumulation (clotting and syneresis of cream dressing) during storage, whereas a higher pH allows for increased growth of contaminating bacteria. The final product should be stored at less than 5°C. Although salt is added in the dressing, the salt in moisture ratio (S/M) of creamed cottage cheese (1–2%) is not high enough to hinder growth of contaminating bacteria. The dressing also contains lactose, which can be fermented by undesirable microorganisms and starter if they survive the heating step.

In properly manufactured creamed cottage cheese, the environmental conditions within the cheese (low acid, relatively high pH, low S/M) are not harsh enough strongly to inhibit growth of most psychrotrophic contaminants. Thus, similar to conditions in raw or pasteurized milk, microorganisms able to grow fastest at low storage temperatures are the dominant ones found in cottage cheese (Cousin, 1982). Gram-negative psychrotrophic bacteria such as pseudomonas (particularly *P. fluorescens*, *P. fragi*, and *P. putida*), Enterobacteriaceae (coliforms, especially *Enterobacter aerogenes*, *E. agglomerans*, and *Escherichia coli*), *Alcaligenes*, *Achromobacter*, and *Flavobacterium* are the contaminants most likely to be found in cottage cheese (Brocklehurst and Lund, 1985; Marth, 1970). All these bacteria are destroyed by pasteurization. *Pseudomonas* spp. are obligately aerobic and predominate at the surface, whereas coliforms are aerobic and facultatively anaerobic and sometimes can be found throughout the cheese. Their growth and metabolism, as well as that of yeasts and molds, result in undesirable flavors (called unclean, putrid, rancid, fruity, and yeasty), surface film (Brocklehurst and Lund, 1985; Davis and Babel, 1954), and discoloration.

As with other cheeses, consumer acceptance of cottage cheese flavor varies considerably. Cottage cheese is consumed as a fresh product (a few days to 4 weeks old) and the ingredients (milk, nonfat dry milk, cream) can all influence the flavor (Bodyfelt et al., 1988). However, three main concerns can be controlled microbiologically: level of acidity, diacetyl (aroma), and level of undesirable flavors. The wash treatment and cream dressing can be used to adjust pH and acidity of cheese. Diacetyl can be added directly as a starter distillate or can be formed in the cream dressing through metabolism of citric acid by *Lc. lactis*

subsp. *lactis* biovar. *diacetylactis* and *Leuconostoc* spp. However, in addition to development of undesirable flavors, *Pseudomonas* spp., *Alcaligenes*, and *E. aerogenes* can oxidize diacetyl to acetoin, a flavorless compound (Seitz, 1963). This results in cheese that is bland or flat in flavor.

Growth of microorganisms in cottage cheese is inhibited most effectively by low storage temperature ($<5^{\circ}\text{C}$), but it is also affected by pH and antimicrobials. Potassium sorbate may be added to control yeasts, molds, and certain bacteria (Liewen and Marth, 1985; Sofos and Busta, 1982), although it may impart bitterness in creamed cottage cheese at levels greater than 0.075% (Bodyfelt, 1981). As with other acids, the effectiveness of sorbate depends on the sensitivity of spoilage organisms and is a function of antimicrobial concentration of the undissociated form of the acid in the aqueous phase (pKa). It is enhanced by lower pH, the symbiotic effect of other antimicrobials, lower initial microbial load, and lower storage temperature. Thus, the degree of shelf life extension resulting from the use of sorbate is directly related to the quality of the initial product and subsequent handling (Bodyfelt, 1981).

Microgard (Wesman Foods, Inc., Beaverton, OR) is grade A skim milk that has been fermented by *Propionibacterium freudenreichii* and then pasteurized. It is widely used by the cottage cheese industry to inhibit growth of gram-negative bacteria, some yeasts, and some molds. The actual inhibitory compound is a bacteriocin (700 D, heat stable, and proteinaceous in nature) (Daeschel, 1989).

Direct injection of CO_2 into cream dressing has been shown to inhibit growth of *Pseudomonas* (Chen and Hotchkiss, 1991), *Listeria monocytogenes*, and *Clostridium sporogenes* (Chen and Hotchkiss, 1993). The technique has been used commercially (Mans, 1995) without the side effect of ‘carbonation’ flavor in the cheese. It is claimed substantially to improve the shelf life. It is believed that the CO_2 enters cells and inhibits growth or kills cells by lowering the pH within the cell. The technique is more effective at 4°C than 7°C .

The relatively short storage time (2–4 weeks) and rapid attainment and maintenance of low temperature during storage (5°C) probably preclude growth of contaminating lactobacilli. However, if the temperature of storage is high enough (7°C), as may occur in retail outlets, metabolism of lactobacilli may be a potential problem. Of particular concern is acid development through metabolism of lactose by either the nonstarter lactobacilli or surviving starter bacteria or lactococci used in fermentation of the cream dressing. Poor acidification results in free whey or watery cheese and an acid-tasting product. Growth and metabolism of psychrotrophic microorganisms are also increased.

In the past, mixed-strain cultures, which included high levels of *Lc. lactis* subsp. *lactis* biovar. *diacetylactis* were inadvertently used. These bacteria produce gas (CO_2) from cometabolism of lactose and citric acid. The gas causes the curd to float, but the curd structure is also disrupted and weakened, leading to curd that is more easily shattered as the curd is stirred (Sandine et al., 1957).

B. Internally Ripened Blue Mold Cheeses

Roquefort, Stilton, blue, and Gorgonzola are examples of cheeses in which development of flavor is dominated by metabolism of *Penicillium roqueforti* or *P. glaucum*. These molds grow throughout cheese (internally ripened) and are able to grow in the low-oxygen, high-salt conditions that are typical of these cheeses (Godinho and Fox, 1981; Golding, 1937). To facilitate exchange of air with CO₂ produced in cheese (via mold metabolism), cheese is manufactured to produce an open texture and is pierced or punched with large-bore needles. If the texture is too tight, mold only grows near the puncture. In addition, internally mold-ripened cheeses may also be surface ripened with yeasts and bacteria (e.g., Stilton); a process that provides for distinctive taste sensations in a number of cheeses, including Limburger.

By international agreement, Roquefort cheese must be made from sheep milk, in the Roquefort Valley of France, and ripened in naturally air-conditioned, high-humidity caves near the town of Roquefort, (Bertozzi and Panari, 1993). Similarly, manufactured cheese produced from cow milk in the United States and other countries is called blue (bleu) cheese. Morris (1981) provides an excellent technical description of the manufacture of blue-veined cheeses.

Blue cheese is usually made from a blend of heat-treated (raw) or pasteurized skim milk and homogenized cream, whereas Roquefort is made from nonhomogenized raw, whole sheep milk. The purpose of homogenization is to break up large fat globules. Sheep milk naturally contains more small globules. Homogenization results in a whiter curd (and increased contrast with the blue mold), increased flavor development through enhanced lipase activity (Morris et al., 1963), and a more porous, crumbly texture. Pasteurization destroys most of the milk lipase, which is believed to aid in ripening of cheese and kills most non-starter bacteria, especially lactobacilli, which might play an important role in overall development of characteristic flavor. Milk is inoculated with spores (10³⁻⁴/mL milk) of *P. roqueforti*. Some manufacturers prefer to inoculate curd instead. Either method ensures that spores and thus flavor development will occur evenly throughout cheese. During manufacture, steps are taken to produce a porous or open texture. The starter is *Lc. lactis*, and citrate-metabolizing strains (*Lc. lactis* subsp. *lactis* biovar *diacetylactis* and *Leuconostoc* sp.) are sometimes added. Carbon dioxide produced through metabolism of citric acid expands mechanical openings in cheese, which in turn allows for more intrusive growth of mold. The coagulum is cut when very firm into large cubes (0.95 cm diameter). The whey and curd mixture is heated to 35–37°C, held for 30 min with agitation, and then whey is removed. Curds may be salted. Dry curds are put into hoops (drained vessels) and allowed to sit for several days at 21–27°C. This encourages complete fermentation of lactose, results in a cheese with a pH of 4.8–4.9, and permits full drainage of whey. The body is desirably brittle and crumbly. Im-

proper whey drainage may result in soft, mushy surface areas during storage. These areas are ideal for growth of yeasts and putrefactive bacteria such as *Pseudomonas* sp. and *Acinetobacter* (Smith et al., 1987).

Cheeses are brine salted or rubbed with salt for several days. Roquefort cheese must be dry salted by regulation. After salting, cheeses are pierced with 0.24-cm diameter needles and placed in a curing room (10°C at 90–95% humidity) for 2–4 weeks or until mold growth begins to appear at openings of holes. Piercing allows for transfer of oxygen and CO₂ to stimulate growth and metabolism of *P. roqueforti*. *P. roqueforti* is more tolerant of low oxygen, high CO₂, and high salt than most other species of molds. After sufficient mold growth, cheeses are wrapped and stored (matured) for 2–4 months at (10°C). In France, later curing of cheese occurs in the famous caves of Roquefort. After proper curing, cheeses are cleaned of surface growth (molds, yeasts) and repackaged for sale.

Metabolism of molds (lipolysis and proteolysis) during maturation is essential for development of the distinctive blue cheese flavor (Goghil, 1979). A distinctive yeast flora also develops on Roquefort, including *Debaromyces hansenii*, *Candida* sp., and *Kluyveromyces lactis* (Besancon et al., 1992). The intensity of mold-derived flavors is so strong that, although other microorganisms are present in such high numbers (yeasts, micrococci, and lactobacilli), their contribution to flavor of blue cheese cannot be ignored, nor neither can it be ascertained.

The salt in moisture in the interior of blue cheeses can be as high as 6–8%. This inhibits growth of lactococci and *Leuconostoc* sp. Free fatty acids released through lipolysis and via oxidative decarboxylation are converted to methyl ketones. Of particular importance in blue-veined cheeses are 2-heptanone and 2-nonanone, without which there is no distinctive blue cheese flavor. Secondary alcohols, methyl and ethyl esters derived from fatty acid metabolism and proteolysis, are essential for the well-balanced and distinctive flavor of blue-veined cheeses (Kinsella and Hwang, 1976). Molds require oxygen to grow, albeit at low levels, for *P. roqueforti*. With *P. roqueforti*, too little oxygen can result in a change in color from blue-green to greenish yellow. This situation can occur if cheese is vacuum packaged. Proper color returns when the cheese is exposed to air.

During initial salting and ripening of blue cheese, there is a conspicuous lack of visible growth of mold and yeasts on the surface. The low pH and high salt content keep the level of these microorganisms in check (Godinho and Fox, 1981). Some manufacturers also use a hot brine treatment (72°C for 20) to kill microorganisms at the cheese surface. However, as cheese matures, salt diffuses in and the pH rapidly increases (5.8 up to 6.5). Yeasts and molds metabolize lactic acid and hydrolyze protein, releasing ammonia and amino acids. Both metabolic activities result in pH increase. During maturation, microorganisms once held in check by adverse conditions (low pH) can begin to grow. Salt-tolerant bacteria

such as *L. monocytogenes* and *Staphylococcus aureus* (de Boer and Kuik, 1987) are of particular concern (see Chap. 13). Since blue cheese is often added as an ingredient to salad dressings, the presence of undesirable bacteria such as heterofermentative lactobacilli can be a potential problem. Although the cheese does not contain any sugar, the dressing may. Metabolism of sugar by heterofermentative lactobacilli produces gas and an unattractive salad dressing.

C. Externally Mold-Ripened Cheeses: Camembert and Brie

Camembert and Brie are essentially the same cheeses, but in France are made in different regions. Brie cheese wheels are also larger in diameter (Masui and Yamada, 1996) and may be produced with *S. thermophilus* starter. Whole milk, sometimes with cream added (double-cream Brie), is inoculated with *Lactococcus* sp. After considerable acid development by the starter, coagulant is added. The coagulum is very firm when cut. This results in a higher moisture cheese. The coagulum is cut into large pieces, 1.6-cm diameter, stirred, and dipped into forms. Alternatively, uncut coagulum may be dipped directly into forms. The height of finished cheese is important, because the degree of ripening of cheese depends on its thickness. Curd settles in forms, which are turned approximately 6–8 h after being filled. There is no cooking or heating step. No pressure is applied. As in blue cheese, the starter continues to produce acid until it becomes self-inhibited at pH 4.7–4.8.

Cheese is removed from forms and brined or dry-salted (salt rubbed or sprinkled on the surface). After salt is absorbed (1 day), spores of *P. camemberti* are sprayed onto the surface. Spores may also be added directly to the milk. Cheese is not pierced as in blue cheese, so mold does not grow in the interior of the cheese unless there is an area of unfused curd (mechanical openings or holes). Cheese is transferred to shelves in rooms of high relative humidity (90–95%) at 10°C. It is placed on mats or perforated sheets to allow air contact with as much surface area as possible. This permits growth of the mold evenly over the entire surface area of the cheese. Cheese is also turned regularly to expose bottom areas and keep soft cheese from being imprinted with the perforated mats or sticking to them. After approximately 2 weeks in ripening rooms, mold has developed sufficiently, and cheese is wrapped for sale. It is then stored at a low temperature (4–7°C) for further ripening (2–4 weeks).

Slow growth of mold may indicate a too-high salt content or too-low pH. To prevent the latter, water may be added to milk or whey to remove some of the lactose before curd is transferred to forms. The practice has also been applied in the manufacture of blue cheese.

Before growth of *P. camemberti*, cheese is firm, crumbly, and acid. As mold grows, it metabolizes lactic acid and hydrolyzes protein. Just beneath the surface growth, cheese is very soft, creamy, and appears slightly translucent and

more yellowish than the interior portion of the cheese. As ripening continues, the interior becomes progressively softer and creamier just as at the surface. This progression is referred to as ripening from the outside to the inside. The change in the body of cheese results, in part, from migration of ammonia from the inside to the outside of the cheese. Migration of ammonia from the outside to the inside of the cheese raises the pH of cheese from 4.8 to >6.5 . This alters hydration of casein with the net result of an increase in fluidity of cheese. With an increase in pH, naturally occurring milk proteinase, plasmin (not active at low pH), hydrolyzes protein, further softening cheese. Eventually, the entire cheese becomes soft and creamy. Overripening either by poor stock maintenance or by design results in cheese that is very fluid and that “runs” when cut open.

Metabolism of *P. camemberti* results in hydrolysis of milkfat (lipolysis) and subsequent oxidative decarboxylation of free fatty acids to methyl ketones (Molimard and Spinnler, 1996). Of particular importance to the flavor of Camembert are 1-octen-3-ol, 1, 5-octadien-3-ol, and 2-methylisoborneol (Karahadian and Lindsay, 1985). In the United States, Camembert and Brie are generally ripened with mold only. However, Karahadian and Lindsay (1985) postulated that growth of *Brevibacterium linens* on cheeses imported from France resulted in development of sulfur compounds: dimethyl disulfide, dimethyl trisulfide, and methional. Other regional differences in flavor may arise from metabolism of particular microflora contaminating the surface of cheese. Nooitgedagt and Hartog (1988) found yeasts (predominantly *D. hansenii*, *Yarrowia lipolytica*, *K. marxianus*, and *Candida* spp.), and *Geotrichum candidum* and a few cheeses with greater than 10^4 staphylococci, greater than 10^5 *E. coli*, and greater than 10^7 Enterobacteriaceae.

D. Cheeses with Eyes

Swiss, baby Swiss, Gouda, and Edam are among cheeses characterized by development of circular openings called eyes. Eyes develop through formation of CO_2 by metabolism of specific secondary bacteria. In Swiss-type cheeses, gas (CO_2) is formed by *P. fruedenreichii* subsp. *shermanii* through metabolism of lactic acid. In Gouda and Edam cheeses, CO_2 is formed from metabolism of citric acid by *Leuconostoc* spp. and *Lc. lactis* subsp. *lactis* biovar *diacetylactis*.

These are the most difficult of cheeses to manufacture because of the strict grading regimen they must pass. Eye development is key, and this is sometimes the only criterion by which these cheeses are graded. Reinbold (1972) and Olson (1969) have provided detailed descriptions on manufacture of these cheeses. The method of manufacture is similar for all cheeses with eyes.

Starters for Swiss and baby Swiss cheese are predominantly *S. thermophilus* with small amounts of *Lb. delbrueckii* subsp. *bulgaricus*, *Lb. helveticus*, and *Lb. lactis*. Depending on the manufacturer, *Lc. lactis* may also be used to ensure fermentation of all sugar, including residual galactose. The propionibacteria are added with the lactic starter.

Lc. lactis is used as starter for Gouda and Edam cheeses. Gouda and Edam are manufactured similarly, but Edam is lower in moisture and fat content.

The main objective in making cheeses with eyes is to produce a pliable curd mass. This is necessary for development of round eyes rather than slits or cracks. Pliability or elasticity of cheese results from both protein density and physicochemistry (strongly influenced by pH and bound calcium). As CO₂ is formed, it accumulates at locations where air has been entrapped during processing or at sites where the curd is not tightly fused. Gas exerts pressure on the protein network. If the protein network is elastic, it bends or gives but does not break, forming an eye. If the protein network cannot withstand the pressure, it breaks and a slit is formed. Elasticity is a phenomenon related to hydration of casein, calcium-phosphate bonding, and electrostatic and hydrophobic interactions between casein molecules. Thus, rate and extent of acid development (pH) at whey drainage and pressing must be carefully controlled. To accomplish this, slow acid development is necessary and separation of curd and whey generally occurs at a relatively high pH.

In Swiss cheese, after cutting, curd is heated to 48–53°C and held for 30–60 min depending on the desired moisture content and pH. In Gouda and baby Swiss varieties, a portion of whey (25% of milk weight) is drained and replaced with hot water to raise the temperature of curds and whey to 38–39°C. Addition of water not only heats curd but also dilutes lactose, thereby controlling the pH of cheese. Alternatively, Swiss cheese manufacturers can control the pH by adding warm water to milk and cold water to cool curd before whey drainage (combined water addition is approximately 7–10% of weight of milk). The high heat used in Swiss cheese manufacture inhibits acid development and partially inactivates the coagulant (depends on type of coagulant). The starter is not killed and resumes acid development as curd cools.

In larger commercial manufacturing plants, regardless of cheese type, curd and whey are pumped together into a smaller vessel or rectangular tower that concentrates curd into a single large mass. Pressure is applied and serum is squeezed from curd.

In the traditional method of Swiss cheese manufacture, all curd from the cheese vat (a round kettle) is enclosed in a cheese cloth, lifted into the cheese form, whey is manually pushed out of the curd mass, and cheese is pressed. Because serum is at a high pH during pressing, less calcium phosphate is dissolved in whey as compared to cheeses of a more acidic nature at drain (Cheddar or mozzarella). Phosphate acts as a buffer and helps keep pH of curd from getting too low. Low pH (5.1) inhibits growth of *Propionibacterium* sp. and is involved in development of a short, inelastic body in cheese. After pressing, the curd mass is brine salted.

To ensure curd fusion and complete sugar metabolism, cheese is held at 7°C (prewarm room) for several days. Cheese is then placed in a warm room (10–13°C for Gouda and 20–26°C for Swiss).

The temperature affects both growth of the eye former and elasticity of the protein network. The warmer the cheese, the more elastic the protein. Rate of gas development is critical. If gas develops too rapidly and the casein network cannot handle the gas pressure, the cheese splits. If gas forms too slowly, the cheese maker may leave cheese in the warm room for too long, resulting in too much proteolysis. When gas does develop, curd is no longer elastic, resulting in splits. After the eyes form, Swiss cheese is cooled and stored (5°C) to prevent further gas development.

Gouda cheese may be ripened for extended periods at the warm room temperature. Because citric acid is limiting in cheese, there is no fear of excessive gas being formed by the added lactococci or *Leuconostoc*. However, in Swiss cheese, there is excess substrate (L-lactic acid) and potential for continued gas formation unless the cheese is cooled (Fedio et al., 1994; Hettinga et al., 1974). The search is underway to find a *Propionibacterium* sp. that does not form gas during storage (Hofherr et al., 1983). Cold cheese is not elastic, so if gas is formed, it expands existing eyes and they split. As cheese ages, casein is hydrolyzed (proteolysis) by residual coagulant, nonstarter bacteria, and plasmin (native milk proteinase). Proteolysis eventually destroys elastic properties of the casein network. Thus, if gas is formed in cheese after much proteolysis has occurred, slits are formed.

In all cheeses with eyes, undesirable gas formation can occur if large numbers of *C. tyrobutyricum* are active. Their growth usually occurs months after cheese is made and after much proteolysis has occurred. The result is split eyes or newly formed large slits called cracks. Metabolism by *C. tyrobutyricum* also results in rancidity and H₂S formation (Langsrud and Reinbold, 1974). The latter gives rise to the term *stinker cheese* or *stinkers* for short. Metabolism at the surface of cheese by *Pseudomonas* spp., yeasts, and enterococci also produce stinkers.

Certain varieties of cheese with eyes, for example, Gruyere and Danbo, are also surface ripened (see Sec. IV. G).

E. Surface-Ripened Cheeses

Limburger and traditional brick cheese are known for their highly malodorous character. For certain individuals, they literally stink; to the connoisseur, they smell in a pleasant sort of way. The strong odors arise from putrefaction of protein, which releases ammonia and sulfide compounds (H₂S and methyl mercaptan).

These cheeses are made from whole milk with *Lactococcus* spp. starters. After cutting the coagulum, a portion of whey is removed (25–50% of milk weight) and replaced with hot water. This raises the temperature and removes lactose from curd, which prevents cheese from becoming too acidic, a develop-

ment that could delay ripening. There are several variations to this procedure, but the net result is the same. After 30–60 min, whey is drained while curd is stirred. If an open-bodied cheese is desired, all or most whey is removed. Curd is put into forms and may or may not be pressed. Once pressed, cheese is brined, “smear,” and placed in a high-humidity room (90–95% relative humidity) at 13–15°C. Cheese is slightly acid after brining (pH 5.2–5.4). The pH depends on amount of whey removed and water added during manufacture. Once brined, cheese is inoculated with the smear. The smear is a mixture of several microorganisms, most importantly yeasts, micrococci, *Arthrobacter* and *B. linens*, which develop as a layer on a cheese surface as it ripens. Smearing is done by scraping the smear layer from an already ripened cheese into a brine solution and then rubbing fresh cheeses with the smear-containing brine. This procedure is repeated every few days until luxurious growth occurs. Microorganisms in the smear may be purchased separately, mixed, and the cheeses inoculated. *Arthrobacter* and *B. linens* give the smear a red-orange color. Yeasts (*D. hansenii*, *Candida* spp., *G. candidum*, and *Y. lipolytica*) metabolize lactic acid and the pH of the cheese increases (Eliskases-Lechner and Ginzinger, 1995; Iya and Frazier, 1949). *Micrococcus* spp. (*M. varians*, *M. caseolyticus*, and *M. freudenreichii*) begin to grow, followed by *B. linens* and *Arthrobacter* (Lubert and Frazier, 1955). The pH must be greater than 5.5 for *B. linens* to grow (Kelly and Marquardt, 1939). Yeasts also synthesize vitamins (pantothenic acid, niacin, and riboflavin), which may be essential for *B. linens* to grow. A symbiotic relationship thus exists between growth of yeasts and *B. linens* (Purko et al., 1951). The length of time the smear is left on cheese and size of cheese influence its flavor intensity.

Limburger cheese is cut into small loaves (6.4 × 6.4 × 13 cm) before smearing, and the smear is not removed. Traditional brick cheeses are larger pieces and, again, the smear is not removed. In less pungent brick cheese, the smear is washed off after 4–10 days. If the smear is left on cheese, ripening continues. Ripening of cheese involves extensive proteolysis, with release of ammonia, H₂S, and methyl mercaptan (Grill et al., 1966). These flavor compounds diffuse into cheese. Metabolism of lactic acid at the surface of cheese, ammonia migration into the cheese, and proteolysis on the inside, caused by coagulant and plasmin, eventually lead to a fluid interior. The cheese is runny when cut. Because of pH increase, microorganisms once held in check by low pH can then begin to multiply. *L. monocytogenes*, staphylococci, and coliforms are of major concern (see Chap. 13).

F. Colby, Sweet Brick, Muenster, Havarti

Colby, sweet brick, Muenster, and Havarti are consumed with minimum ripening, generally between 1 and 3 months. Inferior products are often sold if the cheese is aged for a longer time. These cheeses are low in acid, because lactose is rinsed

from the curd, and they have a pH of approximately 5.2–5.4. Lactococci are used as starter in Colby and brick cheese but *S. thermophilus* is preferred for Muenster. Some manufacturers also use *Lb. delbrueckii* subsp. *bulgaricus* if *S. thermophilus* is used. Havarti cheese is manufactured with lactococci with added *Leuconostoc* sp. and citrate-metabolizing *Lc. lactis* subsp. *lactis* biovar *diacetylactis*. Once the coagulum is cut, curds are heated to 36– to 37°C if lactococci are used as the starter and 39–41°C if thermophilic cultures are used. In Muenster and brick cheeses, there is little or no acid development before putting curd into forms.

In Colby manufacture, the pH of curd at whey drainage is approximately 6.1. Whey is drained and curds are continually stirred as water (30–32°C) is sprinkled on them. This not only cools the curd but also removes lactic acid and lactose. All whey is then removed and curd is salted, put into forms, pressed, and stored. The result is a cheese with a pH of 5.2–5.3 and many mechanical openings. Cool, firm curd does not fuse completely even when pressed. Vacuum packaging closes the openings and cheese forms a tight knit texture, but this is not allowed in authentic Wisconsin Colby.

In Muenster cheese, curd and whey are pumped into rectangular open-ended forms, lightly pressed, brined, and stored. In manufacture of brick and Havarti, once the coagulum is cut, a portion of whey is drained and replaced with hot water to heat curds to 36–37°C. Curds are then handled as with Muenster. The more whey removed before putting curd into forms, the more mechanical openings appear in cheese. Cheeses are brined and stored. Havarti is ripened at 13–16°C for 2–6 weeks; Muenster and sweet brick are stored at 7°C and are ready for consumption within a month.

G. Cheddar Cheese

Cheddar cheese is consumed when it is anywhere from 1 month to several years of age. Pasteurized or heat-treated (67–70°C for 20 s) whole milk is used. *Lactococcus* spp. is the starter, with *Lc. lactis* subsp. *cremoris* being preferred for long-hold cheese. Once the coagulum is cut, curd is heated to 38–39°C. After proper stir-out, whey is completely drained and curd is either continuously stirred (stirred curd Cheddar) or allowed to mat (Cheddared curd, also called milled curd Cheddar). Stirred curd is preferred if the cheese will be used for process cheese. Cheddared curd is preferable for table cheese. Cheddared curd cheese is thought to develop a better flavor and has a smoother body than stirred curd cheese. When the curd reaches the desired pH, curd is salted. In Cheddared curd, the matted curd is cut into large pieces, which are periodically turned (Cheddared) in the vat until the proper pH is reached (pH 5.4–5.5). The slabs of curd are then cut into finger-sized pieces (milled), salted, put into forms, and pressed. Cheeses are generally stored at 7–9°C. There is considerable variation in details of Cheddar cheese manufacture resulting from mechanization of the process, size of vats,

rate of acid development by starter, and whims of the manufacturer. The pH of cheese at 1 week is generally 4.95–5.1.

H. Pasta Filata Cheeses: Mozzarella and Provolone

Manufacture of pasta filata cheeses is almost identical to milled curd Cheddar cheese. *S. thermophilus* (cocci) and *Lb. delbrueckii* subsp. *bulgaricus* or *Lb. helveticus* (rods) are used as starter. The ratio of cocci to rods used varies from manufacturer to manufacturer, but ratios of 1:1, 3:1, 5:1, or 1:0 are commonly used. The cocci are the main acid producers. Lactococci are sometimes added. As with Cheddar cheese, considerable variation exists in manufacture of mozzarella and provolone cheeses. *Mozzarella* is a common name applied to various cheeses made similarly (Code of Federal Regulations, 1995). There is some debate over the appropriateness of allowing non-pasta filata cheese to be called mozzarella; these cheeses are being made and sold as mozzarella especially as a kosher product.

Provolone is lower in moisture but higher in fat than mozzarella cheese. Lipases are added to milk and lipolysis results in a light piquant or rancid flavor in provolone. After the coagulum is cut, the curd and whey mixture is heated to 42–43°C. At pH 6.1, whey is drained and curd may be cut into slabs and stacked. At a pH of 5.15–5.35, curd is milled and placed in a hot-water bath (70–88°C) and kneaded. The pulling or stretching of the molten curd mass gives the pasta filata cheeses their name, but it also imparts a fibrous body to the cheese. The temperature of the cheese (57–63°C) varies with time of exposure to mixing and water temperature. Coagulating enzymes vary in their heat sensitivity and the residual coagulant can play a major role in determining the physical characteristics of cheese (melt, stretch, oiling off, burning, chewiness) (Kindstedt, 1993). Starter may or may not survive the heat treatment of the curd. This has a major impact on metabolism of residual sugar and consequently Maillard-browning reactions when cheese is subsequently heated on pizza (Johnson and Olson, 1985). After curd is stretched, it is shaped (usually into cylinders), placed in cold water to cool, and eventually brined.

High-moisture fresh mozzarella can be eaten immediately, but the more familiar pizza-type mozzarella (low-moisture, part skim) is aged for a few days. This short ripening period (4–7 days) allows for equilibrium between hydrogen ions (H⁺) and colloidal calcium phosphate and for any free moisture within the cheese to be absorbed by the casein network. If water is not absorbed, it (also referred to as expressible serum) will come out during shredding of the cheese. As cheese ages, proteolysis results in an increase in melt and a decrease in stretchability when used in cooking. This occurs in all cheeses but is most noticeable in mozzarella because of demands that are placed on the physical characteristics of this cheese when baked or fried.

The physical properties of any cheese are determined by pH, composition, and proteolysis (Kindstedt, 1993). Thermophilic starter strains do not use the galactose portion of the lactose molecule, and it accumulates in cheese (Hutkins and Morris, 1987). The use of galactose-fermenting starter strains (Mukherjee and Hutkins, 1994) may reduce the level of galactose. Residual galactose and lactose are responsible, in part, for browning of cheese when baked (Johnson and Olson, 1985). Dehydration and scorching of protein during baking results in browning with a darker color in the presence of sugar. Residual sugar is also a prime substrate for heterofermentative lactobacilli and coliforms. Gas formation by these bacteria leads to “blown” cheeses (splits, eyes) and puffy packages. Yeast contamination via brine is also a potential problem.

I. Parmesan and Romano

S. thermophilus (cocci) and *Lb. helveticus* or *Lb. delbrueckii* subsp. *bulgaricus* (rods) are used to manufacture grana cheeses, Parmesan and Romano. The ratio of cocci to rods varies according to the manufacturer but ratios of 1:1, 3:1, or 8:1 are common. Some manufacturers also add a small amount of *Lc. lactis* to ensure complete sugar metabolism. Reduced-fat milk is used for both. Moisture content is low (32% maximum for Parmesan, 34% maximum for Romano). Parmesan must be aged 10 months and has a minimum FDM of 32%, whereas Romano must be aged 5 months and has a minimum FDM of 36% (Code of Federal Regulations, 1995). There is an effort to reduce aging requirements for Parmesan to 6 months. Indeed, some companies have received a temporary variance allowing for the shorter ripening period as long as the cheese has the same flavor as the more aged cheese. Parmesan and Romano are manufactured similarly. The coagulum is cut softer and finer than for other cheeses to ensure a drier finished cheese. Fast acid development by the starter is desired. After cutting, the curd and whey mixture is heated to 45–47°C and stirred until the pH of whey is approximately 5.8–6.0. Whey is then drained. Curds are continuously stirred until all whey is removed. The low pH and high heat during stir-out enhances syneresis. Curds are put into forms (usually 9- to 18-kg wheels), pressed overnight, and brine salted for several days to 2 weeks. Some manufacturers brine only a few days and apply salt to the cheese after it is removed from the brine. This method of salting is called dry salting and may require several days of application to achieve the desired salt level. Alternatively, curds first may be salted, put into forms, and then pressed. This process produces what is referred to as barrel cheese. The cheese is not brine salted, and the process usually requires a longer stir-out and application of less salt. If the salt content is too high, it may inhibit fermentation of all the sugar. Residual sugar may participate in Maillard-browning reactions, especially if the cheese is further dried (with heat) to produce grated cheese. After brining, the cheese is stored at 7–10°C. Traditionally, wheels

of cheese are coated with an oil to prevent mold growth and coated with wax at a later date. Some modern manufacturers coat the cheese with a polymer containing a mold inhibitor (natamycin).

Although Parmesan and Romano cheeses are made similarly, they taste distinctively different. Pregastric esterase or lipase is added to the milk for manufacture of Romano but not to milk for manufacture of Parmesan. Thus, the flavor of Romano is rancid or picante, whereas that of Parmesan is described as sweet and nutty.

J. Reduced-Fat Cheeses

Demand by consumers has led to development of reduced-fat versions of popular cheese varieties. Early attempts did not meet with tremendous success because of poor physical and flavor characteristics. Adjustments to the manufacturing protocol, including the use of selected starter strains and particular attention to dairy plant hygiene, have greatly improved the quality of these cheeses. Young, mild-flavored cheese with a reduction in fat content of 25–33% as compared to the full-fat cheeses have almost, if not actually, duplicated the quality (flavor and body) of the full-fat counterparts. Cheeses with a fat reduction of greater than 50% have yet to achieve similar results. It is more likely that these cheeses have taken on their own unique flavor and are being accepted on their own merits rather than in comparison to other cheeses.

Reduced-fat versions of cheeses are similar to their full-fat counterparts in that they are subject to the same microbiologically induced defects and for the same reasons. However, the ecology (variety of bacteria and changes over time) of the cheeses may or may not be the same; this has not yet been studied. Cheese with less fat is firmer than cheese with higher fat content. To overcome this problem, reduced-fat cheeses are manufactured to contain much higher moisture contents. But higher moisture means higher lactose in the cheese, which, in turn, means that the cheese is high in acid after the starter ferments the sugar. To avoid producing an acidic cheese, many manufacturers of reduced-fat cheeses (regardless of type) use whey dilution or curd rinsing to remove some lactose. However, reduced-fat Cheddar is also being made commercially without a rinse treatment by using a specific manufacturing protocol to retain the buffering capacity of the cheese (Johnson and Chen, 1995). Cheese contains more acid (up to 2% lactic acid compared with less than 1.6% lactic acid in full-fat Cheddar) but both may have the same pH. Compared with full-fat cheeses, most reduced-fat versions are higher in moisture and pH and generally lower in salt (lower S/M) and lactic acid. Thus, the cheese environment and chemistry is not the same between full-fat and reduced-fat cheeses, and the reduced-fat cheeses may be more susceptible to growth of undesirable bacteria, especially coliforms. Of course other contaminants such as lactobacilli also grow more rapidly in lower

salt, lower acid, reduced-fat cheeses. Reduced-fat cheeses may have a tendency to increase in pH more rapidly than full-fat counterparts because of lower acid levels and increased proteolysis. Conditions are thereby created that are more favorable to growth of bacteria in general.

The consequences of reduction of fat on flavor of aged Cheddar cheese are well recognized (i.e., lack of similar flavor intensity at similar age), but the difference in flavor is less evident in reduced-fat versions of cheeses in which the full-fat version is mild-flavored (Muenster, brick, Gouda). Reduced-fat Cheddar cheese made with a curd rinse tastes similar to Colby. Reduced-fat Cheddar made without a curd rinse has more Cheddar flavor than one made with a rinse, but development of flavor still lags behind that of full-fat Cheddar.

Although reduced-fat cheeses have met with some consumer acceptance, there appears to be a universal concern that cheeses not ripened deliberately by yeasts or molds lack flavor. As a result, adjunct bacteria, particularly *Lactobacillus* spp., are being used commercially to enhance cheese flavor.

K. Process Cheese and Cold-Pack Cheeses

Process cheese, cheese spreads, and cheese foods are produced from other cheeses. A mixture of cheeses (may be several varieties, ages, and flavor) is blended with milkfat (butter oil), water, "melting salts" (such as sodium phosphates, citrates) and, in the manufacture of spreads and foods, added whey powders. Depending on type of product and shelf life requirements, the mixture is stirred and heated to 70–140°C for 2–15 min. It is then packaged (filled) or made into slices. The rate of cooling depends on size and shape of cheese but may take several hours to reach temperatures below 38°C. This is in excess of pasteurization, so most microorganisms are killed with the exception of spore formers. Of particular concern are *C. sporogenes*, *C. tyrobutyricum*, *C. butyricum*, *C. botulinum* (see Chap. 13), and *B. polymyxa*. The presence of coliforms or yeasts is indicative of low processing temperature, especially at filling or negligent sanitation. In addition to composition, pH and a_w , the presence of melting salts may be inhibitory to the growth of clostridia (Steege et al., 1995; Tanaka et al. 1986). Nisin will also inhibit growth of clostridia (Roberts and Zottola, 1993).

Cold-pack cheese is prepared by mixing, without the aid of heat, a blend of cheese, acid, salt, flavoring, stabilizers, and water. Cold-pack cheese food may also include whey powder, buttermilk, and nonfat dry milk. Cold-pack cheeses must be made from cheeses made with pasteurized milk or held for at least 60 days at a temperature above 1.67°C. Because such cheese is not heated, microbial quality is subject to microbial content of ingredients. In addition, cold-pack cheese food contains lactose, a readily available food source for many potential contaminants as well as starter bacteria. Starter fermentation of residual lactose can cause the pH to drop and free moisture to appear at the surface of the cheese.

The major microbiological problem with these products is growth of yeasts and molds, especially if free moisture is available at the surface. Antimycotic agents such as potassium sorbate are permitted (not to exceed 0.3%).

VI. CHEESE RIPENING—INFLUENCE OF MICROORGANISMS

Microorganisms found in cheese can be classified into two groups: those that are deliberately added, such as starters and adjuncts, and those that are adventitious contaminants. The primary role of starter bacteria is to produce acid at a consistent rate, but it would be wrong to assume that their role is limited to this. The starter has a major impact on flavor in cheese consumed fresh. As cheese matures, direct contribution to flavor by the starter diminishes as nonstarter flora grow. Although, in most instances, the exact means by which starter bacteria or adjunct microorganisms contribute to development of flavor is controversial, they can both influence cheese maturation. Development of flavor in blue, Camembert, Limburger, Romano, and provolone cheeses is clearly dominated by microorganisms or enzymes deliberately applied to them. With other varieties of cheese, however, development of flavor is not clearly understood. Scores of compounds with the potential to affect flavor have been isolated from a variety of cheeses. But the full duplication of cheese flavor chemically has eluded us.

Olson (1990) described the possible role of starter bacteria in cheese flavor development as follows: fermentation and depletion of fermentable carbohydrates create an environment that controls growth and composition of adventitious flora. This is accomplished through development of acids, creation of low oxidation-reduction potential during early stages of cheese maturation, and competition for nutrients. In addition, starters can develop flavor compounds directly and indirectly through their metabolic activities (Crow et al., 1993). (See Chap. 7 for more details on the influence of carbohydrate metabolism and proteolysis by bacteria on cheese flavor development.)

Autolysis of starters (and adjuncts) releases nutrients that serve as metabolites for other microorganisms in cheese (Thomas, 1987b). Also, activity of released intracellular peptidases can contribute to the increase in the free amino acid pool within cheese (Lane and Fox, 1996). Amino acids can, in turn, be metabolized by other bacteria directly to flavor compounds or can react chemically with other constituents in cheese to produce flavor compounds (Griffith and Hammond, 1989). Any bacteria thriving in cheese can potentially influence flavor of cheese through synthesis of flavorful metabolites. Characterization of flavor in most cheeses is lacking; thus the direct connection between microbial metabolism and cheese flavor is also limited. Another problem hampering the study of influence of starter and nonadded microflora on flavor in cheese is a lack of

consensus on what constitutes cheese flavor, especially in varieties of cheese not ripened by yeasts or molds. There is an element of distrust in that what one person perceives to be true cheese flavor may not be the same as what another might consider to be cheese flavor. Consequently, results of experiments on flavor enhancement or acceleration of flavor development are often met with skepticism.

Starters are the dominant bacteria found in cheese initially. Numbers range from 10^6 to 10^9 /g cheese. As cheese ages, their numbers decrease and numbers of nonstarter bacteria increase. The rate at which this happens depends on strain of starter and initial numbers and type of nonstarter bacteria. Lactobacilli constitute most nonstarter lactic acid bacteria in Cheddar cheese (and probably most cheeses), with the dominant species of quality cheese being *Lb. casei* and *Lb. plantarum* (Fox et al., 1998; Franklin and Sharpe, 1963; McSweeney et al., 1993; Peterson and Marshall, 1990). Heterofermentative lactobacilli may be present with no visible sign of gas production (Laleye et al., 1987). *Lactobacillus* numbers in raw milk are greatly reduced by pasteurization. The presence of lactobacilli in pasteurized milk generally indicates high (10,000/mL) numbers in raw milk or postpasteurization contamination. Type and strains of nonstarter bacteria found in cheese are dependent on initial numbers in milk (especially if raw milk is used), biofilm formation on equipment and subsequent contamination, and ability of individual strains to survive and compete in the cheese environment (pH, salt, a_w , acidity, temperature, availability of nutrients).

Addition of *Lactobacillus* adjuncts has been suggested as a means of controlling numbers of adventitious lactobacilli by, at least initially, outcompeting other microflora in cheese (Martley and Crow, 1993). However, depending on strain, the adjunct culture may die or may not compete well against nonstarter microflora; thus the ecology of cheese can change as it matures. Dominance of cheese microflora by lactobacilli has led to numerous studies advocating addition of defined strains of lactobacilli to milk or cheese to reduce bitterness, enhance flavor, or develop particular textural or physical attributes in the cheese (El-Soda, 1993). Other bacteria, particularly *B. linens*, have also been used commercially to enhance flavor of Cheddar and reduced-fat cheeses. The use of adjunct bacteria to accelerate flavor development has met with some resistance by manufacturers, because the flavor developed in cheese is not the same as flavor of cheese without the adjunct. Consistency of flavor quality is a major goal of the cheese maker. Not surprisingly, reduced-fat varieties of cheese more closely mimic the full-fat counterpart if the same adjunct is used in both cheeses.

VII. ASSESSMENT OF MICROBIOLOGICALLY INDUCED DEFECTS IN CHEESE

It is difficult at times to assess quality problems occurring with cheese. A thorough knowledge of all aspects of cheese making is required for detective work

necessary to determine cause and effect relationships that may lead to a cheese quality problem. Foremost is identification of the problem. Is the problem really microbially related or is it the result of mechanistic shortcomings of manufacture? For example, openings in cheese can be a result of either pressing cold curd (mechanical) or gas formation by heterofermentative bacteria.

Second, if the problem is microbially induced, how did the organism gain access to the product and is the problem exacerbated by the manufacturing protocol, handling, storage, pH, or composition of cheese? For example, residual sugar in cheese because of incomplete fermentation by the starter can be fermented by contaminating heterofermentative bacteria leading to gassy cheese. Incomplete fermentation, in turn, can result from a change in composition of starter because of improper starter preparation. Perhaps cheese was cooled prematurely, too much salt was added, or bacteriophage killed the starter. Regardless of circumstances, a contaminating organism must be present and must grow. If the microorganism is present but does not grow, there is no problem. Many legal questions have arisen because of this simple concept.

The problem results from *growth* of a microorganism. Perhaps, had cheese not been temperature abused, the microorganism would not have grown! Cheese is not made in a sterile environment. It is inevitable that contaminating microorganisms will be present in cheese. It is not inevitable that they will cause a problem in cheese.

Prevention of undesirable growth of microorganisms in cheese involves four steps: (1) Keep the microorganism out of milk or prevent its growth in milk (hygiene on the farm, quickly cooling the milk, short time between milking and cheese making). (2) Kill the bacteria (pasteurization). (3) Manufacture the cheese to prevent contamination (dairy plant hygiene). (4) Create an environment within the cheese so that if the microorganism is present, its growth will be limited (proper pH, salt, fermentation of all sugar, low storage temperature). However, the most universally accepted (but not always properly practiced) method of preventing defects caused by microorganisms is sanitation. In this regard, development of biofilms is important.

Many bacteria can form biofilms or can become associated with them. Biofilms consist of microorganisms immobilized at a surface, typically embedded in an organic polymer matrix of bacterial origin (Marshall, 1992). Biofilms can develop on almost any wet surface (equipment) (Criado et al., 1994). Microorganisms attach to the surface or to other organic material already attached to the surface, excrete copious amounts of extracellular polymers, and grow vigorously, creating a biofilm. Bacteria can form biofilms within a few hours of initial attachment to a surface. As the biofilm becomes thicker, the outer layer is sloughed off as the result of turbulence (e.g., milk stirring in a vat). Microorganisms within sloughed-off pieces contaminate milk. Other organisms can also attach to the biofilm. Sanitizers are less effective against biofilms, because the sanitizer reacts only with the outer layer and extracellular polymers protect microorganisms.

Therefore biofilms must be removed before sanitizers are applied. The cleaning regimen becomes paramount in controlling bacterial contamination (see also Chap. 14).

A. Molds

Airborne mold spores are ubiquitous, but, upon germination, they require oxygen to grow and sporulate. Therefore, mold growth on the surface of cheeses exposed to air is to be expected. Molds are not supposed to grow on cheeses that are vacuum packaged, but they sometimes do. Molds tend to grow on cheese where pockets of air exist between the packaging material and cheese surface (Hocking and Faedo, 1992). Growth is limited by the amount of residual oxygen. Low oxygen levels may dictate species of molds found. The most common molds found on vacuum-packaged Cheddar cheeses are *Penicillium* spp. (especially *P. commune*, a blue mold), and *Cladosporium* spp. (especially *C. cladosporioides*, a black mold). Other molds found on different cheeses include *Aspergillus*, *Fusarium*, *Mucor*, *Scopulariopsis*, and *Verticillium*. *Penicillium* spp. appear to be the dominant type of molds that grow on cheeses (Lund et al., 1995). *P. commune* is the most widespread and frequently occurring species found on all cheese types and in smear of surface-ripened cheeses (Lund et al., 1995). Although *Aspergillus* spp. and *Penicillium* spp. are the dominant fungi isolated from air in cheese plants, *Penicillium* spp. are the dominant fungi isolated from cheese with very low levels of *Aspergillus* also being present.

Potassium sorbate and natamycin are used to control mold growth. Sorbate-resistant strains of *Penicillium* metabolize sorbic acid to yield 1,3-pentadiene, which has a kerosene-like odor (Marth et al., 1966). If sorbic acid is added to the cheese and the cheese is made into processed cheese, the sorbate is diluted. Sensitive strains are then able to grow and may produce 1,3-pentadiene. The maximum amount of sorbic acid permitted for use in cheese is 0.3% by weight (Code of Federal Regulations, 1995), which is not enough to inhibit all strains of *Penicillium* but adequate to inhibit *Aspergillus* spp. (Liewen and Marth, 1984). In cheeses with a rind (e.g., Gouda, Parmesan), a polymer coating is applied to prevent mold contamination and for appearance. Sorbates or natamycin are incorporated into the coating. Sorbates diffuse into cheese and may cause off-flavors, but natamycin diffuses very little and does not give cheese an objectionable flavor (de Ruig and van den Berg, 1985).

B. Yeasts

Although growth of yeasts is desirable in surface-ripened and some mold-ripened cheeses, it is not desirable in most other varieties. The heterofermentative metabolic activity (alcohol and CO₂) of yeasts sometimes makes them particularly

easy to identify as spoilage organisms even though visible colonies are not observed. The cheese tastes yeasty, a taste reminiscent of raw fermented bread dough (Horwood et al., 1987). But not all contaminating yeasts produce the typical yeasty smell. Some very proteolytic yeasts produce stinker cheeses. The smell resembles that of rotten eggs and is often associated with white spots on the cheese surface. Lipolytic activity can lead to rancid flavors (free fatty acids), and the combination of alcohols and free fatty acids can lead to fruity flavors. Although yeasts are commonly associated with slimy surface defects, other putrefactive organisms such as *Pseudomonas* spp. and *Enterococcus* spp. contribute greatly to the defect. A major factor contributing to growth of yeast, or any contaminating organism, is a wet cheese surface. This situation can occur for several reasons. As cheese matures, proteolysis results in release of moisture held by the protein network. If cheese is warmed or if it is ripened at greater than 7–8°C, moisture collects at the surface of cheese; that is, the cheese “sweats.” Moisture (serum) laden with potential nutrients (lactic acid, dissolved peptides, amino acids) accumulates between the packaging material and cheese, setting up an ideal situation for rapid microbial growth. Cheese must first be contaminated. Excellent plant hygiene is necessary, because yeasts are common contaminants in the dairy plant environment (wet surfaces, spilled milk, whey). A major source of yeasts is brines (Kaminarides and Laskos, 1992; Viljoen and Greyling, 1995), and thus brined cheeses tend to be more prone to yeast contamination. In addition, the high salt at the surface of the cheese draws moisture, creating an environment that favors yeasts. The most frequently isolated yeasts are *Candida* spp., *Y. lipolytica*, *K. marxianus*, *G. candidum*, *D. hansenii*, and *Pichia* spp. (Fleet, 1990; Hocking and Faabo, 1992; Rohm, 1992; Viljoen and Greyling, 1995).

Yeasts and molds are common on the surface of rind cheeses, a large group of traditional European cheeses. These are cheeses that are not covered or packaged but rather allowed to mature “in air.” The humid conditions of storage and high-salt environment at the surface (most are brined cheeses) create conditions selective for yeasts and molds. However, with these cheeses, growth of mold and yeasts is expected if not demanded.

C. Gassy Defects in Cheese

In Swiss, Gouda, Havarti, Roquefort, and similar varieties of cheese, the controlled development of gas by bacteria during maturation is desired. The result of gas formation in these cheeses is development of eyes (Swiss, Gouda) and expansion of preexisting mechanical openings deliberately formed during manufacture. In any cheese, however, gas formation can lead to undesirable development of slits, small round eyes (sweet holes), or blown, “puffy” packages. Whether a slit or a sweet hole develops is determined by physical properties of cheese. Eyes are formed if cheese can be deformed without fracturing. This prop-

erty is determined by cheese composition, temperature of cheese, rate of gas formation, and, most importantly, pH and degree of proteolysis (Grappin et al., 1993; Luyten et al., 1991).

In general, a minimum population on the order of 10^6 colony-forming units per gram is necessary before openness from gas production occurs (Martley and Crow, 1996). Nonstarter flora most often associated with slit formation in cheese are obligate heterofermentative lactobacilli, *C. tyrobutyricum*, and facultative lactobacilli. Others encountered but far less often are coliforms, yeasts, "wild" propionibacteria, and *Leuconostoc*. Incidence of slits or blown cheese and causative organism is reflective of microbial quality of milk, overall dairy plant hygiene, heat treatment given milk, post-heat-treatment contamination, rate and extent of acid development, residual sugar, cheese environment, pH, and redox potential. Pasteurization is very effective at killing all coliforms, leuconostocs, and most strains of lactobacilli and greatly reducing the level of all microorganisms except clostridial spores.

Fermentation of residual sugar (lactose or galactose) is a common source of carbon dioxide in cheese (Fig. 1). The level of sugar and speed at which it is eliminated by homofermentative starter is critical. Slow starter activity and incomplete fermentation by thermophilic starters are chief causes of residual

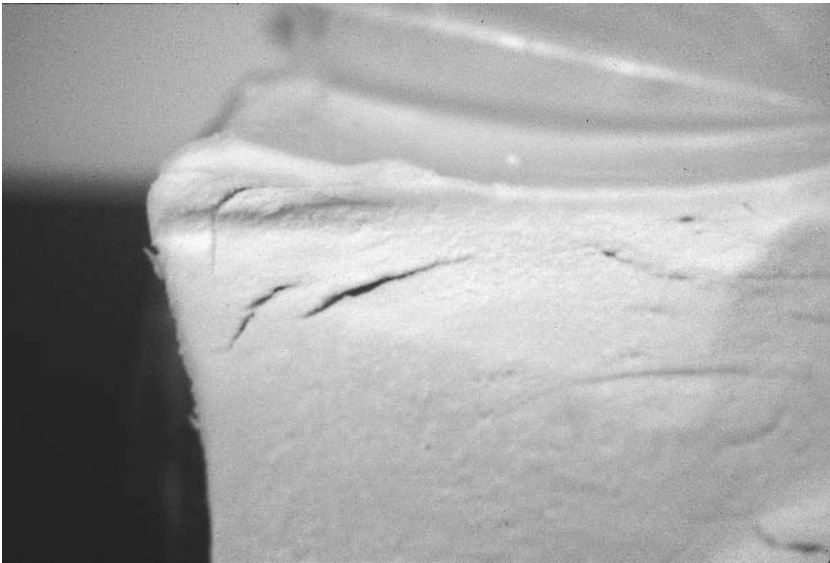

Figure 1 Slits in mozzarella cheese caused by fermentation of residual lactose by *L. fermentum*.

sugar. *S. thermophilus* and *Lb. delbrueckii* subsp. *bulgaricus* do not ferment the galactose moiety of the lactose molecule and release it into cheese. Addition of mesophiles or *Lb. helveticus* to the starter can eliminate galactose from cheese. However, in pasta filata cheeses, the heat treatment given cheese can greatly reduce the level of starter. The starter must be able to ferment sugar at the low temperature (7°C) at which the cheese is stored, an unlikely possibility with thermophilic starter.

Cometabolism of citric and lactic acids by facultative lactobacilli, *Lb. casei*, and *Lb. plantarum*, is another source of carbon dioxide (Fryer et al., 1990; Laleye et al., 1987; Lindgren et al., 1990; Thomas, 1987a). Because facultative lactobacilli are ubiquitous in cheese, their metabolism is regarded as the cause of tiny slits in cheese when no other potential gas-forming bacteria are found.

Lactic acid fermentation by propionibacteria and clostridia is also a major source of gas in cheese. These organisms are regarded as the culprits in late blowing of cheese. As cheese ages, extensive proteolysis results in an increase in pH and release of amino acids, which stimulate their growth. Although many strains of clostridia can ferment lactic acid, *C. tyrobutyricum* is probably the only one that is significant in cheese (Klijn et al., 1995) (Fig. 2).

Other minor contributors to gas formation in cheese are amino acid catabolism (nonstarter lactobacilli, propionibacteria, *Lc. lactis* subsp. *lactis*) and the use



Figure 2 “Blown” provolone cheese contaminated with *C. tyrobutyricum*.

of urea by streptococci (Martley and Crow, 1996). However, decarboxylation of glutamic acid into carbon dioxide and 4-aminobutyric acid is the main source of eye and split formation in cheese made with a particular thermophilic starter composed of *S. thermophilus* and *Lb. helveticus* (Zoon and Allersma, 1996).

D. Discoloration in Cheese

Color is an important sensory attribute of cheese, and consumers avoid cheese that is discolored. Annatto-colored cheeses (Cheddar, Colby) are susceptible to light-induced, oxidation, which turns affected areas pink (Hong et al., 1995). Govindarajan and Morris (1973) reported that hydrogen sulfide produced from amino acid metabolism by nonstarter bacteria in cheese is responsible for formation of a pink precipitate of norbixin, a component of annatto. Cheese color can also be bleached under acid conditions but the color returns as the pH of the cheese increases during maturation. This defect is common when whey is entrapped between curd particles (mechanical openings). Lactose in whey is fermented, forming localized areas of low pH (<5) and consequently bleached color. Color of non-annatto-colored cheeses is influenced by what the animal ate (more grass a more yellow color), fat content (more yellow cheese), homogenization (whiter cheese), and especially pH. At low pH (<5), casein molecules aggregate and diffract light (makes the cheese white). As the pH increases, casein aggregates become more separated and the color becomes more yellow or gray. In skim milk cheeses, cheese will become translucent.

Parmesan, Romano, and Swiss cheeses are susceptible to a defect known as pink ring. As the name implies, a pink ring develops around the outside of the cheese and can progressively develop throughout the cheese from the outside to the inside. The pink becomes brown with age. It is most common in air-ripened cheeses (non-vacuum-sealed cheese). Shannon et al. (1977) implicated metabolism of tyrosine by certain strains of *Lb. helveticus* and *Lb. delbruekii* subsp. *bulgaricus* as the cause for the pink ring defect. The presence of oxygen appears to be necessary for development of the defect. It is more common in stirred-curd direct-salted Parmesan cheese (nonbrined) in which air is incorporated during the lengthy stir-out and is not subsequently removed by fermentation or vacuum packaging. Mallaird browning has also been implicated in pinking in which residual galactose is present in cheese because of metabolism of thermophilic starters. Nonstarter lactobacilli may ferment residual sugar, creating compounds that eventually form the pink to brown color.

Brown or red spots in Swiss cheese have been traced to growth of certain strains of "wild props," *Pr. thoenii* (Baer and Ryba, 1992) or *Pr. jensenii* (Britz and Riedel, 1994). White spots, which are also soft, have been observed on brine-salted cheeses and have been traced to growth of enterococci or yeasts. Enterococci may be in cheese rather than cheese being contaminated via brine. The

cheese environment (higher pH, lower acid, lower salt content) may determine the potential for growth of enterococci.

E. Calcium Lactate Crystals

White crystalline material on the surface of Cheddar and Colby cheese is often confused with mold growth. It is, however, calcium lactate, a racemic mixture of L(+) and D(-)-lactic acid (Severn et al., 1986) (Fig. 3). Lactose fermentation by *Lactococcus* spp. produces L(+)-lactic acid. Growth of nonstarter lactic acid bacteria, particularly lactobacilli and pediococci, racemize L(+)-lactic acid to D(-)-lactic acid (Thomas and Crow, 1983). Crystals can also form in the interior of cheese but generally form where moisture (serum) can collect (Johnson et al., 1990b). Not all crystalline material is calcium lactate but may be composed of tyrosine (from proteolysis) or calcium phosphate (Conochie and Sutherland, 1965). Recently, crystals of only L(+)-lactic acid have been isolated from Cheddar cheese (M. Johnson, personal observation), and the cheese does not contain high levels of lactobacilli or pediococci. Manufacturing practices allowing for high calcium and lactic acid in cheese exacerbate calcium lactate crystallization. Loose packaging which allows moisture to collect at the surface of the cheese also leads to higher incidence of calcium lactate crystals.



Figure 3 Calcium lactate crystals on Cheddar cheese.

REFERENCES

- Atlas RM, Bej AK. Polymerase chain reaction. In: Gerhardt P, Murray RGE, Wood WA, Krieg NR, eds. *Methods for General Molecular Bacteriology*. Washington, DC: American Society for Microbiology, 1994.
- Baer A, Ryba I. Serological identification of propionibacteria in milk and cheese samples. *Int Dairy J* 2:299, 1992.
- Bertozzi L, Panari G. Cheeses with appellation d'origine contrôlée (AOC): factors that affect quality. *Int Dairy J* 3:297, 1993.
- Besancon X, Smet C, Chabaliere C, Rivemale M, Reverbel JP, Ratomahenina R, Galzy P. Study of surface yeast flora of Roquefort cheese. *Int Dairy J* 17:9, 1992.
- Bodyfelt FW. Sensory and shelf-life characteristics of cottage cheese treated with sorbic acid. *Proceedings of the Second Biennial Marschall International Cheese Conference*, Madison, WI, 1981, pp 406–425.
- Bodyfelt FW, Tobias J, Trout GM. Sensory evaluation of cultured milk products. In: *The Sensory Evaluation of Dairy Products* New York: Van Nostrand Reinhold, 1988, p 227.
- de Boer E, Kuik D. A survey of the microbiological quality of blue-veined cheeses. *Neth Milk Dairy J* 41:227, 1987.
- Britz TJ, Riedel K-HJ. *Propionibacterium* species diversity in Leerdammer cheese. *Int J Food Microbiol* 22:257, 1994.
- Brockelhurst TF, Lund BM. Microbiological changes in cottage cheese varieties during storage at 7°C. *Food Microbiol* 2:207, 1985.
- Carini S. Lysozyme: activity against clostridia and use in cheese production—a review. *Microbiol Aliments Nutr* 3:299, 1995.
- Chen JH, Hotchkiss JH. Effect of dissolved carbon dioxide on the growth of psychrotrophic organisms in cottage cheese. *J Dairy Sci* 74:2941, 1991.
- Chen JH, Hotchkiss JH. Growth of *Listeria monocytogenes* and *Clostridium sporogenes* in cottage cheese in modified atmosphere packaging. *J Dairy Sci* 76:972, 1993.
- Code of Federal Regulations. Title 21. Part 133. Cheeses and related cheese products. Rockville, MD: Office of the Federal Register National Archives and Records Administration, 1995, p 295.
- Coghill D. The ripening of blue vein cheese: a review. *Aust J Dairy Technol* 34:72, 1979.
- Collins EB. Resistance of certain bacteria to cottage cheese cooking procedures. *J Dairy Sci* 44:1989, 1961.
- Conochie J, Sutherland BJ. The nature and cause of seaminess in cheddar cheese. *J Dairy Res* 32:35, 1965.
- Cousin MA. Presence and activity of psychrotrophic microorganisms in milk and dairy products: a review. *J Food Prot* 45:172, 1982.
- Crow VL, Coolbear T, Holland R, Pritchard GG, Martley FG. Starters as finishers: starter properties relevant to cheese ripening. *Int Dairy J* 3:423, 1993.
- Criado M, Suárez B, Ferreirós CM. The importance of bacterial adhesion in the dairy industry. *Food Technol* 48(2):123, 1994.
- Daeschel MA. Antimicrobial substances from lactic acid bacteria for use as food preservatives. *Food Technol* 43(1):164, 1989.

- Davis PA, Babel FJ. Slime formation on cottage cheese. *J Dairy Sci* 37:176, 1954.
- de Ruig WG, van den Berg G. Influence of the fungicides sorbate and natamycin in cheese coatings on the quality of the cheese. *Neth Milk Dairy J* 39:165, 1985.
- Drake M, Small CL, Spence KD, Swanson BG. Rapid identification of *Lactobacillus* sp. in dairy products using the polymerase chain reaction. *J Food Prot* 59:1031, 1996.
- Eliskases-Lechner F, Ginzinger W. The yeast flora of surface-ripened cheeses. *Milchwissenschaft* 50:458, 1995.
- El Soda M. Accelerated maturation of cheese. *Int Dairy J* 3:531, 1993.
- Emmons DB, Tuckey SL. *Cottage Cheese and Other Cultured Milk Products*. New York: Pfizer, 1967.
- Fedio WM, Ozimek L, Wolfe FH. Gas production during the storage of Swiss cheese. *Milchwissenschaft* 49:3, 1994.
- Fitzsimmons NA, Cogan TM, Condon S, Beresford T. Phenotypic and genotypic characterization of non-starter lactic acid bacteria in mature cheddar cheese. *Appl Environ Microbiol* 65:3418, 1999.
- Fleet GH. A review: yeasts in dairy products. *J Appl Bacteriol* 68:199, 1990.
- Fox PF, McSweeney PLH, Lynch CM. Significance of non-starter lactic acid bacteria in cheese. *Aust J Dairy Technol* 53:83, 1998.
- Franklin JG, Sharpe ME. The incidence of bacteria in cheese milk and cheddar cheese and their association with flavor. *J Dairy Res* 30:87, 1963.
- Fryer TF, Sharpe ME, Reiter B. Utilization of milk citrate by lactic acid bacteria and "blowing" of film wrapped cheese. *J Dairy Res* 37:17, 1970.
- Godinho M, Fox PF. Effect of NaCl on the germination and growth of *Penicillium roqueforti*. *Milchwissenschaft* 36:205, 1981.
- Golding NS. Gas requirements of mold 1. *Penicillium roqueforti*. *J Dairy Sci* 20:319, 1937.
- Govindarajan S, Morris HA. Pink discoloration in cheddar cheese. *J Food Sci* 38:675, 1973.
- Grappin R, Lefier D, Dasen A, Pochet S. Characterizing ripening of Gruyère de Comté: influence of time X temperature and salting conditions on eye and slit formation. *Int Dairy J* 3:313, 1993.
- Griffith R, Hammond EG. Generation of Swiss cheese flavor compounds by reactions of amino acids with carbonyl compounds. *J Dairy Sci* 72:604, 1989.
- Griffiths MW, Phillips JD, Muir DD. Thermostability of proteases and lipases from a number of species of psychrotrophic bacteria of dairy origin. *J Appl Bacteriol* 50:289, 1981.
- Grill H Jr, Patton S, Cone JF. Aroma significance of sulfur compounds in surface-ripened cheese. *J Dairy Sci* 49:409, 1966.
- Herman LMF, De Ridder HFM, Vlaemynck GMM. A multiplex PCR method for the identification of *Listeria* spp. and *Listeria monocytogenes* in dairy samples. *J Food Prot* 58:867, 1995.
- Hettinga DH, Reinbold GW, and Vedamuthu ER. The split defect of Swiss cheese. 1. Effect of strain of *Propionibacterium* and wrapping material. *J Milk Food Technol* 37:322, 1974.
- Hocking AD, Faebo M. Fungi causing thread mould spoilage of vacuum packaged cheddar cheese during maturation. *Int Dairy J* 16:123, 1992.

- Hofherr LA, Glatz BA, Hammond EG. Mutagenesis of strains of *Propionibacterium* to produce cold-sensitive mutants. *J Dairy Sci* 66:2482, 1983.
- Hong CM, Wendorff WL, Bradley RL. Factors affecting light-induced pink discoloration of annatto-colored cheese. *J Food Sci* 60:94, 1995.
- Horwood JF, Stark W, Hull RR. A fermented, yeasty flavour defect in cheddar cheese. *Aust J Dairy Technol* 42:25, 1987.
- Hull R, Toyne S, Haynes I, Lehman F. Thermoduric bacteria: a reemerging problem in cheesemaking. *Aust J Dairy Technol* 47:91, 1992.
- Hutkins RW, Morris HA. Carbohydrate metabolism by *Streptococcus thermophilus*: a review. *J Food Prot* 50:876, 1987.
- Iya KK, Frazier WC. The yeast in the surface smear of brick cheese. *J Dairy Sci* 32:475, 1949.
- Johnson EA, Nelson JH, Johnson ME. Microbiological safety of cheese made from heat-treated milk. Part II. Microbiology. *J Food Prot* 53:519, 1990a.
- Johnson ME, Chen CM. Technology of manufacturing reduced-fat cheddar cheese. In: Malin EL, Tunick MH, eds. *Chemistry of Structure-Function Relationships in Cheese*. New York: Plenum Press, 1995, p 331.
- Johnson ME, Olson NF. Non-enzymatic browning of mozzarella cheese. *J Dairy Sci* 68:3143, 1985.
- Johnson ME, Riesterer BA, Chen C, Tricoli B, Olson NF. Effect of packaging and storage conditions on calcium lactate crystallization on the surface of cheddar cheese. *J Dairy Sci* 73:3033, 1990b.
- Kaminarides SE, Laskos NS. Yeasts in factory brine of feta cheese. *Aust J Dairy Technol* 47:68, 1992.
- Karahadian C, Lindsay RC. Contribution of *Penicillium* sp. to the flavors of Brie and Camembert cheese. *J Dairy Sci* 68:1865, 1985.
- Kelly CD, Marquardt JC. The influence of hydrogen ion concentration and salt on the surface flora of Limburger cheese. *J Dairy Sci* 23:309, 1939.
- Kindstedt PS. Effect of manufacturing factors, composition, and proteolysis on the functional characteristics of mozzarella cheese. *Crit Rev Food Sci Nutr* 33:167, 1993.
- Kinsella JE, Hwang D. Biosynthesis of flavors by *Penicillium roqueforti*. *Biotechnol Bioeng* 18:927, 1976.
- Klijn N, Nieuwendorf FFJ, Hoolwerf JD, van der Waals CB, Weerkamp AH. Identification of *Clostridium tyrobutyricum* as the causative agent of late blowing in cheese by species-species PCR amplification. *Appl Environ Microbiol* 61:2919, 1995.
- Laleye LC, Simard RE, Lee B-H, Holley RA, and Giroux RN. Involvement of heterofermentative lactobacilli in development of open texture in cheeses. *J Food Prot* 50:1009, 1987.
- Lane CN, Fox PF. Contribution of starter and adjunct lactobacilli to proteolysis in cheddar cheese during ripening. *Int Dairy J* 6:715, 1996.
- Langsrud T, Reinbold GW. Flavor development and microbiology of Swiss cheese—a review. *J Milk Food Technol* 37:26, 1974.
- Liewen MB, Marth EH. Inhibition of penicillia and aspergilli by potassium sorbate. *J Food Prot* 47:554, 1984.
- Liewen MB, Marth EH. Growth and inhibition of microorganisms in the presence of sorbic acid: a review. *J Food Prot* 48:364, 1985.

- Lindgren SE, Axelsson LT, McFeeters RG. Anaerobic L-lactate degradation by *Lactobacillus plantarum*. FEMS Microbiol Lett 66:209, 1990.
- Lubert DJ, Frazier WC. Microbiology of the surface ripening of brick cheese. J Dairy Sci 38:981, 1955.
- Lund F, Filtenborg O, Frisvad JC. Associated mycoflora of cheese. Food Microbiol 12: 173, 1995.
- Luyten H, van Fleet T, Walstra P. Characterization of the consistency of Gouda cheese: rheological properties. Neth Milk Dairy J 45:33, 1991.
- Mans J. Looking for Mr. Longlife. Dairy Foods 96:65, 1995.
- Marshall KC. Biofilms: an overview of bacterial adhesion, activity, and control at surfaces. ASM News 58:202, 1992.
- Marth EH. Spoilage of cottage cheese by psychrophilic microorganisms. Cultured Dairy Prod J 5:14, 1970.
- Marth EH, Capp CM, Hasenzahl L, Jackson HW, Hussong RV. Degradation of potassium sorbate by *Penicillium* sp. J Dairy Sci 49:197, 1966.
- Martley FG, Crow VL. Interactions between non-starter microorganisms during cheese manufacture and ripening. Int Dairy J 3:461, 1993.
- Martley FG, Crow VL. Open texture in cheese: the contributions of gas production by microorganisms and cheese manufacturing practices. J Dairy Res 63:489, 1996.
- Masui K, Yamada T. French Cheeses. New York: DK Publishing, 1996.
- McSweeney PLH, Fox PF, Lucey JA, Jordan KN, Cogan TM. Contribution of the indigenous microflora to the maturation of cheddar cheese. Int Dairy J 3:613, 1993.
- Molimard P, Spinnler HE. Review: compounds involved in the flavor of surface mold-ripened cheeses: origins and properties. J Dairy Sci 79:169, 1996.
- Morris HA. Blue-Veined Cheeses. New York: Pfizer, 1981.
- Morris HA, Jezeski JJ, Combs WB, Kuramoto S. Free fatty acids, tyrosine, and pH changes during ripening of blue cheese made from variously treated milks. J Dairy Sci 46: 1, 1963.
- Mukherjee KK, Hutkins RW. Isolation of galactose-fermenting thermophilic cultures and their use in the manufacture of low browning mozzarella cheese. J Dairy Sci 77: 2839, 1994.
- Nooitgedagt AJ, Hartog BJ. A survey of the microbiological quality of Brie and Camembert cheese. Neth Milk Dairy J 42:57, 1988.
- Olson NF. Ripened Semisoft Cheeses. New York: Pfizer, 1969.
- Olson NF. The impact of lactic acid bacteria on cheese flavor. FEMS Microbiol Rev 87: 131, 1990.
- Peterson SD, Marshall RT. Nonstarter lactobacilli in cheddar cheese: a review. J Dairy Sci 73:1395, 1990.
- Purko M, Nelson WO, Wood WA. The associative action between certain yeasts and *Bacterium linens*. J Dairy Sci 34:699, 1951.
- Reinbold GW. Swiss Cheese Varieties. New York: Pfizer, 1972.
- Roberts RF, Zottola EA. Shelf-life of pasteurized process cheese spreads made from cheddar cheese manufactured with a nisin producing strain. J Dairy Sci 76:1829, 1993.
- Rohm H, Eliskases-Lechner F, Bräuer M. Diversity of yeasts in selected dairy products. J Appl Bacteriol 72:370, 1992.
- Salama MS, Sandine WE, Giovannoni SJ. Isolation of *Lactococcus lactis* subsp. *cremoris*

- from nature by colony hybridization with rRNA probes. *Appl Environ Microbiol* 59:3941, 1993.
- Sandine WE, Anderson AW, Elliker PR. How to avoid floating curd when making cottage cheese. *Food Engin* 29:84, 1957.
- Seitz EW, Sandine WE, Elliker PR, Day EA. Distribution of diacetyl reductase among bacteria. *J Dairy Sci* 46:186, 1963.
- Seyvern DJ, Johnson ME, Olson NF. Determination of lactic acid in cheddar cheese and calcium lactate crystals. *J Dairy Sci* 69:2027, 1986.
- Shannon EL, Olson NF, Deibel RH. Oxidative metabolism of lactic acid bacteria associated with pink discoloration in Italian cheese. *J Dairy Sci* 60:1693, 1977.
- Smith DA, Mikolajcik EM, Lindamood JB. Causative organisms and chemical nature of the Swiss cheese rind rot defect. *Cultured Dairy Products J* 22:9, 1987.
- Sofos JN, Busta FF. Sorbates. In: Branen AL, Davidson PM, eds. *Antimicrobials in Foods*. New York: Marcel Dekker, 1983, p 141.
- Stadhouders J, Spoelstra SF. Prevention of the contamination of raw milk by making good silage. *Bulletin of the IDF # 251:24*, 1990.
- Tanaka NE, Traisman E, Plantinga P, Finn L, Flom W, Meske L, Guggisberg J. Evaluation of factors involved in antibotulinal properties of pasteurized process cheese spreads. *J Food Prot* 49:526, 1986.
- Ter Steeg PF, Cuppers HGAM, Hellemons JC, Rijke G. Growth of proteolytic *Clostridium botulinum* in process cheese products: 1. Data acquisition for modeling the influence of pH, sodium chloride, emulsifying salts, fat dry basis, and temperature. *J Food Prot* 58:1091, 1995.
- Thomas TD. Acetate production from lactate and citrate by non-starter bacteria in cheddar cheese. *NZJ Dairy Sci Technol* 22:25, 1987a.
- Thomas TD. Cannibalism among bacteria found in cheese. *NZJ Dairy Sci Technol* 22: 215, 1987b.
- Thomas TD, Crow VL. Mechanism of D(-)-lactic acid formation in cheddar cheese. *NZJ Dairy Sci Technol* 18:131, 1983.
- Viljoen BC, Greyling T. Yeasts associated with cheddar and Gouda making. *Int Dairy J* 28:79, 1995.
- Zoon P, Allersma D. Eye and crack formation in cheese by carbon dioxide from decarboxylation of glutamic acid. *Neth Milk Dairy J* 50:309, 1996.

12

Fermented By-Products

David R. Henning

*South Dakota State University
Brookings, South Dakota*

I. INTRODUCTION

The manufacture of cheese from milk generates approximately 9 lb of whey for each 1 lb of cheese. This by-product of cheese manufacturing has posed serious disposal problems for many cheese makers. Table 1, shows that sweet whey, derived from most rennet-coagulated cheeses, is approximately 93% water and 6.35% solids, with about 76% of the solids being lactose. Acid whey, derived from acid-coagulated cheeses, is compositionally similar to sweet whey except it has higher lactic acid and ash contents. Using a ratio of 9 lb of whey produced for each 1 lb of cheese, it can be calculated that approximately 74 billion lb of whey was produced in 1998 when U.S. cheese production (including cottage cheese curd) totaled 8.23 billion lb, according to the National Agricultural Statistical Service, USDA (1999). Approximately 1.18 billion lb of dry whey was produced for human and animal consumption. This dry whey represents approximately 25% of the whey solids resulting from cheese manufacture during the year. The remaining whey solids were used as concentrated whey for human and animal food (122 million lb), whey protein concentrates (288 million lb), lactose (469 million lb), partially delactosed and demineralized whey (105 million lb), whey solids in wet blends (37 million lb), fermented whey products (including ethanol production), sewage disposal, land disposal, or animal feed.

As cheese-manufacturing plants increase in size, the use of sewage treatment facilities, land disposal, and return of whey to farmers become less viable options. Whey disposal through sewage systems can overload the treatment facilities by its high biochemical oxygen demand (BOD). The BOD for whey is be-

Table 1 Composition of Some Commercial Fluid and Dried Wheys

Component	Fluid sweet whey ^a	Fluid acid whey ^b	Condensed acid whey	Dried sweet whey	Dried acid whey
Total solids, %	6.35	6.5	64.0	96.5	96.0
Moisture, %	93.70	93.50	33.5	3.5	4.0
Fat, %	0.5	0.04	0.6	0.8	0.6
Protein total, %	0.8	0.75	7.6	13.1	12.5
Lactose, %	4.85	4.90	34.9	75.0	67.4
Ash, %	0.50	0.80	8.2	7.3	11.8
Lactic acid ^c , %	0.05	0.40	12.0	0.2	4.2

^a From Cheddar cheese.

^b From cottage cheese.

^c Estimated true lactic acid after substituting basic acidity.

Source: Adapted from Mavropoulou and Kosikowski, 1973.

tween 30,000 and 60,000 ppm (Sienkiewicz, 1990). A plant discharging 1000 gal of whey to a sewage system creates a load equivalent to that of more than 1000 domestic users.

The component of whey that poses the greatest disposal problem is lactose. Ultrafiltration of whey in production of whey protein concentrates results in a deproteinized effluent that retains nearly the same level of BOD as the original whey. To deal effectively with the whey problem, lactose must be removed from the waste stream and converted to nonpolluting products. Several industrial products are derived from whey. Refined food-grade lactose can be used in the pharmaceutical industry for compression with additives into pills, used as carriers for antibiotic powder, or used in infant foods. Some industrial products derived from lactose by chemical processes are lactulose, lactitol, lactitol palmitate, lactosyl urea, lactobionic acid, galactooligosaccharides, and galactose/glucose syrups (Yang and Silva, 1995). This chapter describes some of the fermentation options that convert lactose and whey into products that can relieve the burden of whey disposal for cheese manufacturers. Production of methane from lactose and dairy wastes is discussed in Chapter 18. The discussions in this chapter are grouped into human food products and industrial products.

Fermentation of lactose is one form of energy-yielding microbial metabolism in which the organic substance, lactose, is incompletely oxidized and another organic compound acts as the electron acceptor. The microbial fermentation processes do not result in stoichiometric conversion of lactose into the desired products, because the microorganisms use lactose as a source of carbon for cellular processes.

Fermentation products from whey were reviewed by Marth (1970). Since that review, the most significant change in the techniques of whey fermentation processes has been membrane processing of whey to customize the feedstock for fermentations. Ultrafiltration allows separation of proteins from lactose-rich permeate. Reverse osmosis allows concentration of lactose to more usable levels and thereby assists in obtaining desired fermentation endproducts at levels that make economic recovery possible; for example, to obtain a beer with 4–5% ethanol instead of 2–2.5%. This increased ethanol level makes the distillation process more cost efficient. The use of electrodialysis can reduce the mineral level in concentrated whey and permeate preparations. High mineral content of concentrated whey retards microbial growth.

Anaerobic digestion of whey or whey permeate is discussed in Chapter 18. The primary product from the anaerobic digestion is biogas, a mixture of CO_2 and CH_4 with small amounts of H_2 and H_2S .

II. WHEY FERMENTATION BY-PRODUCTS

A. Food Products

1. Wine

Whey wines can be made from whey or whey permeates with a final alcohol content of approximately 2.25–14.0%. The fermentation of lactose to carbon dioxide and ethanol results in 0.54 g of ethanol for each gram of lactose. The alcohol content of a wine derived from cheese whey would be approximately 2.4%, assuming there is an efficiency of approximately 90% conversion of the lactose to ethanol.

Kosikowski and Wzorek (1986) prepared whey wines from a reconstituted acid whey powder. They removed the proteins by ultrafiltration. The permeate had a total solids concentration of 26–28% before demineralizing to a mineral level of 1% or less. Any residual whey taints after fermentation were removed with bentonite and charcoal at the levels of 5 and 2 g/L, respectively.

Processes for whey wine production before the advent of ultrafiltration were limited to a low alcohol percentage in the final wine. The lactose level of the fermentable whey had to be increased to about twice the level of the desired alcohol content of the finished product. Without mineral removal techniques, growth of most ethanol-producing yeasts and bacteria would be inhibited. To overcome these limitations, whey was fortified with other fermentable carbohydrates. According to Sienkiewicz and Riedel (1990), the most common carbohydrate additives are sucrose and glucose, although honey has been used. Demineralization of the carbohydrate-fortified whey before fermentation was recommended by Larson (1976).

2. Whey Champagne

Serwovit, whey champagne, is produced in Poland (Sienkiewicz and Riedel, 1990). The starting material is deproteinated acid whey, sucrose and caramelized sugar, a dry yeast, fruit flavoring, and water. Yeast and fruit flavorings are added to the pasteurized base of whey, water, and sugars. The mixture is bottled and the fermentation occurs in the bottle at 18°C in 8–12 h.

3. Whey Beers

Whey beers are produced with and without malt addition (Sienkiewicz and Riedel, 1990). Whey has a high mineral content similar to wort obtained from malt mash. Also, caramelization of the lactose develops a flavor suggestive of dried malt. The use of beta-galactosidase to hydrolyze lactose provides the brewer's yeast with the glucose moiety of lactose, but galactose is generally not fermented. The use of ultrafiltration to provide a protein-free permeate has improved the flavor by removing insoluble proteins which have a distinctive flavor. The makers of whey beers are particularly concerned that all the fat be removed so the foaming ability of beer is not suppressed. Hops are usually brewed into the beer.

A malted whey beer contains a maximum of 30% whey and is brewed with hops. Bottom-fermenting yeasts are used with this product.

A whey malt beer is a sweeter beverage that contains a maximum of 50% whey and additional fermentable carbohydrates such as starch and glucose syrup. Hops are brewed into the beer and the color is adjusted with roasted malt. A top-fermenting yeast is used. This product is pasteurized and a secondary fermentation with yeast and added sugar proceeds before bottling.

A whey-nutrient beer is weakly alcoholic. It is brewed from deproteinated whey and hops and has a mineral mix added to it before fermentation. The product is pasteurized before bottling.

Elmer and Clark (1982) reported on the use of an 85.0% hydrolyzed whey permeate as a replacement for 12.2% of the brewing extract in production of beer. The permeate was produced by reverse osmosis and had approximately 18% total solids. A 50-barrel brew was produced and held for 5 months. Flavor stability and foam character were similar to those of commercial brews from the same brewer.

Supplementing mash with lactose and lactase (0.2% of the weight of the added lactose) gave good results according to Polish workers (Sienkiewicz and Riedel, 1990).

4. Beer-like Beverages

Russian workers developed two beverages in the late 1960s that contained added sugar, flavorings, and raisins (Sajanschshaukas, 1968). Botschyu is brewed with

hops and fermented with yeasts; it contains approximately 3.8% alcohol. The other, Bodrost, is fermented with kefir fungi and lactic acid bacteria.

5. Other Fermented Beverages

Rivella has been a popular sparkling fermented whey beverage with an alpine herb flavor (Susli, 1948). Introduced in Switzerland in 1952, this product is a fermented deproteinized whey condensed to a 7:1 concentration. Flavoring and sugar are added to the concentrate, and it is refiltered, diluted to beverage strength, and carbonated before bottling.

Gefilus, available in Europe, is an apricot-peach flavored drink prepared by fermenting a lactose-hydrolyzed cheese whey with a patented strain of *Lactobacillus casei* ssp. *rhamnosum* (*Lactobacillus* GG or Gefilac). The whey drink contains 10^8 colony-forming units per milliliter of the strain GG. The drink is accepted by consumers who do not like traditional fermented dairy products (Salminen et al., 1991).

B. Industrial Products

1. Culture Media

Richardson et al. (1977) pioneered work on the use of fresh Cheddar or Swiss cheese whey as a low-cost alternative to nonfat dry milk or commercial bacteriophage-inhibitory media for propagation of lactic starter cultures for cheese makers. Incorporation of a phosphate-stimulant blend provided protection for the lactic starter culture organisms against bacteriophage action and provided minerals and vitamins needed for acceptable activity. The recommended use of the phosphated whey medium (PWM) was in a system incorporating pH control. The fortifying phosphate-stimulant blend consists of 44.4% NaH_2PO_4 , 42.2% Na_2HPO_4 , 8.66% Ardamine "Yes" (a dehydrated yeast autolysate), Yeast Products, Inc., Paterson, NJ, 4.43% NZ Amine NAK (a protein hydrolysate), Quest International, Norwich, NY, 0.22% MgSO_4 , 0.04% MnSO_4 , and 0.04% FeSO_4 . The phosphate-stimulant blend is added to liquid Cheddar or Swiss cheese whey at a rate of 1.17%. The PWM is heated to 89–95°C for 45 min, cooled to 21–27°C, and inoculated with the desired culture strains. Incubation of the culture in a specially equipped tank allows monitoring of the pH of PWM and controlled addition of neutralizing agents such as NH_4OH , anhydrous ammonia, or NaOH to maintain the pH in a range of 6.0–6.3.

Starter cultures prepared with the PWM-pH control procedure have greater activity than those grown in conventional bacteriophage-inhibitory or milk media. The amounts of PWM-pH control starter culture needed for Monterey cheese manufacture was 20–33% of the amount of milk medium starter culture.

Cheese made with PWM-pH control was normal in all parameters, including yield.

Whitehead et al. (1993) reviewed the subject of starter media for cheese making and introduced the concept of internal neutralization of the lactic acid produced during starter culture production. The acid-neutralizing components of the medium can be added as insoluble salts, which dissolve when acid is produced, or they may be encapsulated in compounds that gradually release neutralizing compounds during acid production. Experiments reported by this group showed that neutralized starters maintain their activity for longer periods (up to 10 days) than starter cultures prepared in unneutralized milk or phage-inhibitory media. Trials with the internally neutralized medium in cottage cheese manufacture by Ogden (1981) showed a reduction of 42% in the amount of starter was possible in comparison to skim milk starter. This work also showed an increase in curd yield of 2.8%.

2. Ethanol

Several lactose-fermenting yeasts can produce ethanol during the fermentation of lactose. Strains of *Kluyveromyces marxianus* (formerly *K. fragilis*), *Torula cremoris*, and *Candida kefir* efficiently convert lactose to ethanol. The strain *K. marxianus* NRRLY 2415 produced up to 12% ethanol for Kosikowski and Wzorek (1982) from a demineralized acid whey permeate with 24% lactose in 7–14 days at 30°C. Laboratory studies by Rogosa (1947) indicated a 91% conversion of lactose to alcohol, but Rajagopalan and Kosikowski (1982) were only able to obtain 84.3% of the theoretical maximum yield, or about 0.45 g of ethanol, from each gram of lactose.

Commercial whey to ethanol facilities in the United States are based on the integrated Carbery process developed at Express Dairy in West Cork, Irish Republic. The ethanol plant was commissioned in April 1978 and is located on site at a cheese-manufacturing plant that has condensing and drying capabilities. Cheddar cheese whey is ultrafiltered, with the retentate destined for whey protein concentrate (WPC) powders and the permeate as a feedstock for the ethanol fermenters. A bottom-fermenting yeast culture and fresh permeate are pumped to one of six 25,000-gallon fermenter vessels. The vessels are similar in design to those used in English breweries. They have a cone bottom and are 50 ft in height and 12 ft in diameter. Large compressors inject filtered air into the bottom of the fermenter tanks. This injection of air prevents the yeast from settling. The fermentation requires approximately 20 h. The cheese operation generates about 110,000 gallons of permeate per day, so a battery of six 25,000-gallon fermenters allows one fermenter to be filling, one to be emptied, and four to be in active fermentation at any time. At the end of fermentation, fermenter contents, which contain approximately 2.8% alcohol, are centrifuged and the yeast cream is recov-

ered. The clear liquid is pumped to a balance tank until it is distilled. After distillation, the ethanol is 96.5% by volume (Sandbach, 1981). The residue from the still has a BOD that is reduced to approximately 5–10% that of the whey permeate.

The Carbery process has been improved by several of the whey ethanol operations in the United States. One improvement is preconcentration of the whey permeate by reverse osmosis to increase the lactose concentration to obtain a greater percentage of ethanol in the fermenter.

Although food-grade ethanol can be converted into other products such as acetic acid, the use for most ethanol is in gasoline blends. National Chemical Products in South Africa initiated whey fermentation in the mid-1970s for alcohol fuel production. Other countries that produce alcohol fuel from whey fermentation are Canada, France, Ireland, Japan, the Netherlands, New Zealand, and the United States. In the United States, the largest whey to alcohol facility is at the Golden Cheese Company in Corona, CA. This integrated operation processes more than 2.25 million lb of whey per day and makes more than 150,000 lb of whey protein concentrate human food ingredients and 50,000 gal of 200-proof (100%) fuel-grade ethanol per week. The ethanol plant has eight 48,000-gal fermenters that are used to batch ferment the lactose to ethanol in 18–30 h. Yeast is recovered from beer (4–5% ethanol) and reused in subsequent batches for up to 10 times. The beer is collected in two beer wells until it is heated and distilled. The distillation process uses glycol to form an azeotrope (Morris, 1986). After distillation of the azeotrope, 200-proof ethanol is obtained. The residues after distillation are further processed into animal feed proteins. The BOD level of the waste stream is reported to be less than 10,000 ppm (Ahmed, 1991).

Cheese whey or whey permeate has a relative cost advantage as a substrate for ethanol production. If permeate is used, costs include transportation, ultrafiltration, and concentration. However, the cheese manufacturer avoids the cost of reducing the BOD of whey at the cheese-making facility. Although corn starch has been the substrate used for most fuel ethanol in the United States, production costs of ethanol from corn depend on the price of corn and the value of by-products associated with the ethanol produced. The 1995 corn to ethanol industry included 43 plants in 20 states producing 1.4 billion gal of ethanol. This ethanol from corn used 5.3% of the U.S. corn crop of 1994.

Zhou and coworkers (1992) at the University of Nebraska–Lincoln developed a cofermentation process to combine whey and corn substrates. The cost of alcohol production from corn is high relative to whey because of the value of the corn. Corn represents about half the cost of the ethanol. A process that could provide approximately 28% of the fermentable carbohydrates from whey can positively affect the economics of the process. Also, a whey ethanol plant is usually limited in capacity by the availability of whey in the region.

A cofermentation process could use all the whey available and still have the cost advantages of a large ethanol production facility. Acid or sweet whey or their permeates can be used as the liquid portion of the corn mash. The cofermentation process requires a staggered inoculation procedure. Lactose fermentation requires a high level of *K. marxianus* inoculum followed by the addition of *Saccharomyces cerevisiae* for fermentation of the α -amylase-hydrolyzed corn starch. *S. cerevisiae* is tolerant of higher alcohol concentrations and can yield a final concentration of more than 9.5% ethanol in 72 h. The Nebraska process trials achieved an alcohol yield 29% higher than with corn alone, or 3.3 gal per bushel of corn.

3. Vinegar

Ethanol produced from whey can be used as a substrate for production of vinegar. The alcoholic fermentation is terminated when formation of acetic acid starts. *Acetobacter* and *Gluconobacter* species used to convert alcohol to acetic acid oxidize ethanol, so there must be a plentiful supply of oxygen. There are at least four industrial methods for conversion of ethanol to acetic acid.

4. Lactic Acid

Lactic acid from cheese whey is produced commercially in Slovakia, Italy, and the United States. Whereas synthetic production from acetaldehyde or lactonitrile is cheaper, the low cost of whey makes a large-scale production facility competitive. The starting materials for lactic acid production include rennet and acid wheys and their permeates. Lactic acid bacteria such as *Lactococcus lactis*, *Lb. delbrueckii* subsp. *bulgaricus*, *Lb. acidophilus*, *Lb. helveticus*, *Lb. casei*, and mixed cultures of these organisms have been successfully used to convert lactose to lactic acid. Fermentation of whey or whey permeate requires enrichment with approximately 0.5% corn steep liquor, 0.1% glucose, 0.05% beta-galactosidase, and several other growth factors (Rosenau, 1986). The pH is maintained in the range of 5–6 by neutralization of the lactic acid with CaCO_3 , Ca(OH)_2 , or 27% NH_4OH . After 85–90% of lactose is fermented, usually in 24–48 h, the pH is adjusted to 12 with Ca(OH)_2 . The liquid is then boiled, allowed to settle, and filtered to remove whey proteins and calcium phosphate. The pH is adjusted to 7. Calcium lactate crystallizes and is redissolved by adding H_2SO_4 and ZnSO_4 at about 95°C. Calcium sulfate and zinc lactate are formed after stirring for 2 h. After sedimentation occurs, calcium sulfate is removed by centrifugation and the zinc lactate solution is cooled to 10°C and allowed to crystallize for 48 h. Zinc lactate crystals are harvested and treated with H_2SO_4 . After a second filtration, the liquid is electrodialyzed to remove heavy metals, excess sulfuric acid, and other impurities.

5. Propionate

Production of propionic acid from lactose and lactate by *Propionibacterium freundenrichii* was the basis of a patent by Sherman and Shaw (1923). Whey was fortified with pulverized limestone, which led to formation of calcium salts of propionic and acetic acids, and then the salts are recovered. A preferred use of calcium and sodium propionates is in bakery products. They have relatively no effect on yeast growth, but inhibit growth of spoilage molds and *Bacillus* species, which causes ropiness in bakery products.

6. Calcium Magnesium Acetate

An innovative product proposed by Yang and coworkers (1992) at Ohio State University is production of calcium magnesium acetate (CMA) for use as a road deicer. A sequential conversion of lactose to lactate and then to acetate with a yield of greater than 90% acetate was developed. The fermentations are carried out in continuous, immobilized cell bioreactors. *Lc. lactis* is the culture used for the homolactic fermentation of the lactose to lactate. *Clostridium formicoaceticum* ATCC 27076 is used for fermenting the lactate to acetate. The overall yield of acetate from lactose in this laboratory trial was approximately 95%. This compares with yields of approximately 60% conversion to acetate in the aerobic vinegar process. The acetate concentration obtained from permeate was approximately 4%. Therefore, recovery and concentration of acetic acid becomes a significant portion of the process. A mixture of 50% Alamine 336, a tertiary amine from the Cognis Corp., Tucson, AZ, in 2-octanol was the solvent selected to extract acetic acid from the fermentation process. Acetic acid was completely stripped from the solvent and reacted with CaO/MgO solution to form CMA by vigorous mixing. CMA produced from lactose had deicing ability similar to commercial CMA.

Calcium magnesium acetate has been identified by the U.S. Federal Highway Administration as one of the most promising alternative road deicers to the currently used salt. Salt corrodes bridge metals and concrete on highways. Also, salt is harmful to vegetation and is a threat to ground water quality in some regions. However, salt costs approximately 5% as much as currently available CMA (30 vs \$650/ton). An estimated cost of \$215/ton for CMA was calculated when using a 1.5-million lb whey permeate per day feedstock entering a facility with a \$7,000,000 capital investment. The output of CMA would be about 40 tons per year.

7. Beta-Galactosidase

Beta-galactosidase is an industrially important enzyme that has application in producing dairy products with reduced lactose content. It has been used to prevent sandiness in ice cream, for example. However, the most compelling reason for

use of lactase is to provide products for consumers with lactose malabsorption. There are industrial applications requiring lactose hydrolysis, such as fermentation of lactose by a non-lactose-fermenting yeast.

Myers and Stimpson (1956) patented a process to produce lactase. The process involved heat coagulation of whey proteins at pH 4.5. The clear supernatant liquid was fortified with 0.1% corn steep liquor and a nitrogen source. After cooling to 30°C, the substrate was inoculated with 10% of a culture of actively growing *K. marxianus*. The patent suggested both aerated and nonaerated incubation. When aerated, one volume of air per volume of medium per minute was the rate of aeration. Yeast cells were washed to improve flavor and then dried. Yeast was stored at 4.4°C until used in a lactose fermentation.

Several commercial companies have isolated beta-galactosidase from yeast. Gist-brocades, Delft, the Netherlands, isolated its Maxilact from *K. marxianus*. Sumitomo of Osaka, Japan, uses *Aspergillus oryzae* as the source of lactase. These companies have bound these lactose-splitting enzymes to support materials to provide immobilized enzymes for commercial applications.

8. Other Fermentation Products from Whey

Table 2 lists fermentation products that have been produced from whey, and thus it is technically feasible to manufacture these products. In most instances, the economic potential is poor or unknown (Hobman, 1984).

Table 2 Fermentation Products from Whey with Limited Potential for Commercialization

Food-grade yeast/single-cell protein	Amino acids
Bakers' yeast	Vitamins
Acetone/butanol	Riboflavin
Methane	B12
Food acids	Ascorbic acid
Citric	2-Keto-L-gulonic acid
Lactobionic	Antibiotics/penicillin
Itaconic	Other biochemicals
Malic	D(-)-3-hydroxy-butyric acid
Enzymes/ β -galactosidase	Gibberellic acid
Food gums	2,3,-Butylene glycol
Xanthan	Hydrogen
Pullulan	Diacetyl
Alginic acid	Calcium gluconate
Indican	Pyruvic acid

Source: Hobman, 1984.

REFERENCES

- Ahmed I, Morris D. Trends in Cheese Whey Production and Utilization. An Alternate Feedstock for Alcohol Fuel Production in the United States. Washington, DC: Institute for Local Self-Reliance, 1991, pp 1–19.
- Elmer RA, Clark WS Jr. A new whey of doing it. *Modern Brewery Age*, December, 1982.
- Hobman PG. Review of processes and products for utilization of lactose. *J Dairy Sci* 67: 2630, 1984.
- Kosikowski FV, Mistry VV. Cheese and Fermented Milk Foods. Vol 1. Stamford, CT: Kosikowski, 1997, p 427.
- Kosikowski FV, Wzorek W. Whey wine from concentrates of reconstituted acid whey powder. *J Dairy Sci* 60:1982, 1986.
- Larson PK, Yang HY. Some factors of clarification of whey wine. *J Milk Food Technol* 39:614, 1976.
- Marth EH. Fermentation products from whey. In: Webb BH, Whittier EO, eds. *Byproducts from Milk*. Westport, CT: AVI, 1970, pp 43–82.
- Mavropoulou IP, Kosikowski FV. Free amino acids and soluble peptides of whey powders. *J Dairy Sci* 56:1135, 1973.
- Morris C. New plant of the year-Golden Cheese Company of California. *Food Eng*, March, 1986.
- Myers RP, Stimpson EG. Production of lactase. U.S. patent 2,762,749, 1956.
- National Agricultural Statistics Service. Dairy Products Summary. Washington, DC: U.S. Department of Agriculture, 1999.
- Ogden LV. Whey starter for commercial cottage cheese (abstr). *J Dairy Sci* 64(suppl 1): 53, 1981.
- Rajagopalan K, Kosikowski FV. Alcohol from membrane processed concentrated cheese whey. *I&EC Product Res Dev* 21:82, 1982.
- Richardson GH, Cheng CT, Young R. Lactic bulk culture system utilizing a whey-based bacteriophage inhibitory medium and pH control. I. Applicability to American style cheese. *J Dairy Sci* 60:378, 1977.
- Rogosa M, Browne HH, Whittier EO. Ethyl alcohol from whey. *J Dairy Sci* 30:263, 1947.
- Rosenau JR. Lactic acid production from whey via electro dialysis. In: Le Maguer M, Jelen P, eds. *Food Engineering and Process Application*. Vol 2. New York: Elsevier, 1986, pp 245–250.
- Sajanschshankas PV. Dairy beverage “Bachyu” made from whey. *Molnaya Promyshlennost* 29:12, 24–25, 1968. Cited in *Dairy Sci Abstr* 31:844, 1969.
- Salminen, S, Gorbach, S, Salminen, K. Fermented whey drink and yogurt-type product manufactured using *Lactobacillus* strain. *Food Technol* 45(6):112, 1991.
- Sandbach DML. Production of potable grade alcohol from whey. *Cultured Dairy Prod J* 16(4):17–19, 22, 1981.
- Sherman JM, Shaw RH. Process for the production of propionates and propionic acid. U.S. Patent 2,826,502, 1923.
- Sienkiewicz T, Riedel C-L. Whey and Whey Utilization. Gelsenkirchen-Buer, Germany: Verlag Th Mann, 1990.

- Susli, H. New type of whey utilization: a lactomineral table beverage. Proc 14th Int Dairy Cong 1 (Pt.2):477, 1948.
- Whitehead WE, Ayres JW, Sandine WE. Symposium: recent developments in dairy starter cultures: microbiology and physiology. A review of starter media for cheese making. J Dairy Sci 76:2344, 1993.
- Yang S-T, Silva, EM. Novel products and new technologies for use of a familiar carbohydrate, milk lactose. J Dairy Sci 78:2541, 1995.
- Yang S-T, Zhu H, Lewis VP, Tang I-C. Calcium magnesium acetate (CMA) production from whey permeate: process and economic analysis. Resources Conservation and Recycling 7:181, 1992.
- Zhou KP, Yang HH, Shahani RK, Whalen PJ, Shahani KM. Producing alcohol fuel from whey and co-products. Proceedings, Whey Products Conference, Chicago, April 29-30, 1992, pp 37-42.

13

Public Health Concerns

Elliot T. Ryser

*Michigan State University
East Lansing, Michigan*

I. INTRODUCTION

Milk, a highly nutritious food ideally suited for growth of both pathogenic and spoilage organisms, is the basis for an extremely large industry in the United States. In 1999, more than 162 billion lb of milk were produced by 9.15 million dairy cows, with total sales exceeding \$23 billion (Anonymous, 2000). Even though dairy products are consumed daily by most individuals in the United States, milk, ice cream, and cheese are still among the safest foods marketed and have most recently accounted for less than 1.5% of all foodborne illness cases reported annually (Bean et al., 1996). Dairy products manufactured in the United States continue to be safer than those produced in many other countries with 2, 4, 6, and 8% of all foodborne outbreaks in France, Spain, Scotland, and Germany, respectively, traced to milk products during 1987 (Notermans and Hoogenboom-Verdegaal, 1992). However, two outbreaks in 1985—the first involving up to 85 deaths in southern California from *Listeria*-contaminated cheese and the second in the Chicago area in which more than 16,000 cases of salmonellosis were traced to one particular brand of pasteurized milk—reaffirms the need for continued vigilance by the dairy industry to safeguard public health.

Outbreaks of milkborne illness date from the inception of the dairy industry. Bacterial infections including diphtheria, scarlet fever, tuberculosis, and typhoid fever predominated before World War II and were almost invariably linked to consumption of raw milk, with the greatest public health concerns at that time perceived to be poor sanitation, inadequate milk-handling procedures, and animal health issues. Although reports of experimental milk pasteurization first appeared in public health literature during the early 1900s, supporters of the certified raw

milk movement denounced pasteurization, claiming that this practice led to nutritional deficiencies and flavor defects and allowed marketing of “sterilized filth.” Conversely, the pasteurized milk movement maintained that certified milk was unsafe despite adherence to strict sanitary practices. In 1923, the Public Health Service began publishing summaries of gastrointestinal outbreaks attributed to milk. These early surveillance efforts soon led to passage of the first Model Milk Ordinance, which stressed nationwide pasteurization and eventual reduction in the incidence of milkborne enteric diseases with no milkborne cases of diphtheria, scarlet fever, tuberculosis, or typhoid fever being reported in more than 40 years. However, interstate shipment of raw milk continued to be legal until 1973. Banning the interstate shipment of all raw milk products, both certified and noncertified, in 1986 reduced the annual number of raw milk-related outbreaks by about half (2.7 outbreaks/yr during 1973–1986 vs 1.3 outbreaks/yr during 1987–1992) (Headrick et al., 1998). As of May 1995, 28 states still permitted sale of raw milk, the volume of which accounted for <1% of all milk sold. Hence, sporadic illnesses continue to be reported, however, particularly among farm families who routinely consume milk from their own dairy herds and in states where raw milk is still legally sold (Headrick et al., 1997).

The importance of various etiological agents in milkborne disease has changed dramatically over time, with routine pasteurization of milk having a significant impact. However, more than 90% of all reported cases of dairy-related illness continue to be of bacterial origin with at least 21 milkborne or potentially milkborne diseases currently being recognized (Table 1). Typhoid fever and scarlet fever accounted for most cases of milkborne illness until the late 1930s. During and shortly after World War II, brucellosis, salmonellosis, and staphylococcal poisoning emerged as major public health concerns, with salmonellosis continuing to be the most important dairy-related illness currently in terms of overall numbers of cases. As reports of staphylococcal poisoning subsided during the 1970s, campylobacteriosis emerged as a major public health concern for those individuals who still drank raw milk. From 1973 to 1992, *Campylobacter*, accounted for 26 of 46 raw milk-associated outbreaks in the United States and 1100 of 1733 cases of illness (Headrick et al., 1998). In 1985, as many as 85 people in California died of cheeseborne listeriosis, a rare and seldom diagnosed disease that was previously only weakly associated with consumption of raw and pasteurized milk. More recently, *Escherichia coli* O157:H7 has emerged as a serious threat to the dairy industry with several outbreaks of potentially fatal hemolytic uremic syndrome reported in Wisconsin and Oregon. Even though they are able to cause potentially serious health problems, the rickettsiae (i.e., *Coxiella burnetii*), parasites (i.e., *Cryptosporidium*) and viruses (i.e., hepatitis A, Norwalk, rotavirus) are each responsible for less than 1% of all dairy-related illnesses, with chemical contaminants other than aflatoxin also posing minimal public health concerns. Despite modern-day epidemiological strategies and extensive labora-

tory testing, a significant number of reasonably large and noteworthy outbreak investigations still fail to identify a specific cause of illness (Anonymous, 1984b; Headrick et al., 1998; Maguire et al., 1991; Osterholm et al., 1986).

The types of dairy products implicated in outbreaks of disease since 1900 are listed in Table 2. Consumption of raw milk and cream was the leading cause of dairy-related illnesses before 1950, with numerous outbreaks of typhoid and scarlet fever being reported. Although the number and size of these outbreaks have decreased in response to increased pasteurization, approximately one-third of all dairy-related illnesses still involve raw milk, with most of these outbreaks presumably confined to states where the sale of raw milk is still legal and to small family farms (Headrick et al., 1997). Except for the unusually large 1985 salmonellosis epidemic in the Chicago area, few additional outbreaks have been positively linked to pasteurized milk in recent years. Nonfat dry milk and butter, which are generally far less supportive of bacterial growth, have posed relatively few public health problems. However, numerous outbreaks have been traced to cheese, particularly Cheddar and soft surface-ripened varieties, which support growth and/or extended survival of such noted milkborne pathogens as *Salmonella*, *Listeria monocytogenes*, *Staphylococcus aureus*, and certain strains of *E. coli*. The number of ice cream-related outbreaks has steadily increased. From 1900 to about 1925, ice cream was most commonly associated with typhoid fever. Thereafter, staphylococcal poisoning emerged and predominated through the 1950s. Recent popularity of homemade ice cream containing eggs has led to a rapid increase in the number of outbreaks involving *Salmonella*, principally *Salmonella* Enteritidis. Consequently, many individuals would consider these recent outbreaks to be more closely linked to eggs than to dairy products.

Based on the Food, Drug and Cosmetic Act of 1938, pasteurized milk and dairy products are considered adulterated and therefore unfit for human consumption if they contain potentially hazardous levels of pathogenic microorganisms, toxins, drugs, or other hazardous substances. In accordance with federal law, the Food and Drug Administration requests that firms voluntarily recall such adulterated products from the market. Hence, an examination of dairy product recalls offers another means of assessing the importance of current public health concerns.

Adoption of a "zero tolerance" policy for *L. monocytogenes* in milk and dairy products had a profound economic impact on the dairy industry. From 1985 through 1999, 70 cheese recalls (primarily soft and surface-ripened varieties) were issued along with 48 ice cream recalls involving more than 4 million gallons of product (Ryser and Marth, 1999). Even though the number of *Listeria*-related recalls has decreased markedly, similar product trends can be seen in the period from 1990 to December 2000, with *L. monocytogenes* still being responsible for 71% of all dairy product recalls (Table 3). Other reasons for recalling dairy products, principally cheese, during this period have included the presence of *E. coli*

Table 1 Percentage of Milkborne and Dairy Product–borne Outbreaks of Various Causes Reported in the United States from 1900 to 1997

Cause	1900– 1909	1910– 1919	1920– 1929	1930– 1939	1940– 1949	1950– 1959	1960– 1969	1970– 1979	1980– 1982	1983– 1987	1988– 1992	1993– 1997
Total bacterial	100	99	96	92	71	83	67	52	92	65	74	23
<i>Bacillus cereus</i> poisoning	—	—	—	—	—	—	—	—	1	—	—	—
Botulism	—	1	<1	1	—	1	—	—	—	—	—	4
Brucellosis	—	—	—	1	8	4	9	1	—	3	<1	—
Campylobacteriosis	—	—	—	—	—	—	—	3	40	32	14	4
<i>Citrobacter freundii</i>	—	—	—	—	—	—	—	—	—	—	—	—
<i>Corynebacterium</i>	—	—	—	—	—	—	—	—	—	—	—	—
Diphtheria	8	2	4	1	1	—	—	—	—	—	—	—
<i>E. coli</i> diarrhea	—	—	—	—	—	—	—	1	1	8	3	—
<i>E. coli</i> O157:H7	—	—	—	—	—	—	—	—	—	—	1	9
Haverhill fever	—	—	<1	—	—	—	—	—	—	—	—	—
Johne’s and Crohn’s diseases	—	—	—	—	—	—	—	—	—	—	—	—
Listeriosis	—	—	—	—	—	—	—	—	—	—	—	4
Paratuberculosis	—	—	—	—	—	—	—	—	—	—	—	—
Salmonellosis	—	1	3	2	7	21	28	42	50	19	56	65
Scarlet fever	14	15	18	27	8	—	—	—	—	—	—	—
Shigellosis	—	—	1	2	4	3	—	—	—	—	—	—

Staphylococcal poisoning	—	—	—	8	26	50	30	5	—	—	—	—
Streptococcus	—	—	—	—	—	—	—	—	—	3	—	—
Tuberculosis	<1	<1	<1	<1	<1	<1	—	—	—	—	—	—
Typhoid fever	78	80	68	50	17	3	—	—	—	—	—	—
Yersiniosis	—	—	—	—	—	—	—	1	—	—	—	—
Total rickettsial	0	0	0	0	0	1	0	0	0	0	0	0
Q fever	—	—	—	—	—	1	—	—	—	—	—	—
Total parasites	0	0	0	0	0	0	0	1	0	0	0	0
Cryptosporidiosis	—	—	—	—	—	—	—	—	—	—	—	—
Tickborne encephalitis	—	—	—	—	—	—	—	—	—	—	—	—
Toxoplasmosis	—	—	—	—	—	—	—	1	—	—	—	—
Total viral	0	<1	<1	0	<2	0	2	1	1	0	>1	0
Hepatitis	—	—	—	—	<1	—	2	1	1	—	>1	—
Poliomyelitis	—	<1	<1	—	<1	—	—	—	—	—	—	—
Total chemical	0	0	0	0	0	0	0	4	<1	11	6	0
Aflatoxin and other mycotoxins	—	—	—	—	—	—	—	—	—	—	—	—
Antibiotics	—	—	—	—	—	—	—	—	—	—	—	—
Chemicals	—	—	—	—	—	—	—	3	<1	11	6	—
Histamine poisoning	—	—	—	—	—	—	—	1	—	—	—	—
Unknown etiology	<1	1	3	8	26	17	31	41	6	24	18	13

Sources: Bryan (1983), Bean et al. (1996), and Olsen et al. (2000).

Table 2 Percentage of Reported United States Outbreaks Involving Various Dairy Products: 1900–1997

Product	1900– 1909	1910– 1919	1920– 1929	1930– 1939	1940– 1949	1950– 1959	1960– 1969	1970– 1979	1980– 1987	1988– 1992	1993– 1997
Milk	—	—	—	—	—	—	36	—	62	30	34
Raw milk and cream	100	86	93	90	54	36	—	23	—	—	—
Certified raw milk	—	—	1	—	—	2	—	4	—	—	—
Pasteurized milk	—	4	3	3	16	2	—	3	—	—	—
Nonfat dry milk	—	—	—	—	2	2	—	4	—	—	—
Cheese	—	1	<1	3	9	34	20	17	19	14	14
Butter	—	1	—	—	<1	—	—	4	—	—	—
Ice cream	<1	8	2	4	17	24	44	44	19	56	52
Number of outbreaks	173	333	390	403	301	45	39	94	58	36	29

Sources: Bean et al. (1990), Bean et al. (1996), Bryan et al. (1983), MacDonald et al. (1986), and Olsen et al. (2000).

Table 3 Number (%) of Microbiologically Related FDA Recalls Issued for Dairy Products: 1990–December 2000

Agent	Product					Total
	Fluid milk and cream	Butter	Ice Cream and frozen yogurt	Dried milk and whey	Cheese	
<i>L. monocytogenes</i>	1	4	23	—	38	66 (71)
<i>C. botulinum</i>	—	—	—	—	7	7 (11)
<i>Salmonella</i>	—	—	1	2	—	3 (5)
Mold	—	—	—	—	4	4 (3)
<i>E. coli</i>	—	—	—	—	3	3 (3)
Aflatoxin	1	—	—	—	—	1 (2)
<i>Cryptosporidium</i>	—	—	—	—	1	1 (2)
Total	2 (2)	4 (5)	24 (28)	2 (2)	53 (63)	85

Source: FDA Enforcement Reports 1990–2000.

and potentially toxigenic molds as well as presence of *Cryptosporidium* and changes in cheese spread formulations that may lead to potential growth of *Clostridium botulinum* and the accompanying threat of botulism.

In this discussion, the various public health concerns affecting the dairy industry have been organized into three arbitrary categories. The first section of this chapter deals with public health concerns primarily of historical interest such as diphtheria, scarlet fever, tuberculosis, and typhoid fever. Major public health concerns of current interest are discussed in greater detail in the following section and include the common bacterial infections (e.g., campylobacteriosis, listeriosis, salmonellosis) and intoxications (e.g., staphylococcal poisoning) as well as potential health concerns related to the presence of aflatoxins and drug residues in the milk supply. Uncommon and suspected milkborne bacteria, rickettsiae, parasites, viruses, and toxins responsible for infrequent dairy-related illnesses are briefly reviewed in the last section; a few of these etiological agents are likely to increase in significance within the next 10–20 years.

II. HISTORICAL CONCERNS

The presence of pathogenic bacteria in milk has been a matter of public health concern since the early days of the dairy industry. From the turn of the century to 1940, numerous health hazards were associated with ingesting raw milk and dairy products prepared from raw milk. Typhoid fever, the primary milkborne

disease during this period, accounted for 50–80% of all milk-related illnesses, with scarlet fever being responsible for an additional 14–27% of milkborne infections (Bryan, 1983). Both of these diseases were frequently fatal, because suitable treatments, such as with antibiotics, were unavailable. The high incidence of milkborne typhoid and scarlet fever, coupled with sporadic dairy-related outbreaks of diphtheria, poliomyelitis, and tuberculosis, soon confirmed the need for increased pasteurization, a process that was used only sporadically during the 1920s and 1930s. After World War II, almost universal adoption of pasteurization, coupled with modernization of milk production practices emphasizing improved farm and dairy factory sanitation, udder health, herd inspection, and cooling, handling, and storage of milk have, for all practical purposes, eliminated the threat of these diseases, with the last cases of milkborne typhoid fever, scarlet fever, and diphtheria in the United States being reported more than 40 years ago.

A. Diphtheria

Dreaded by mothers of small children for more than 2000 years, diphtheria has come to be one of the best understood and controlled human bacterial diseases, with long-standing immunization programs virtually eliminating diphtheria in the United States, Canada, and most of Europe. *Corynebacterium diphtheriae*, the bacterial pathogen responsible for diphtheria, is an obligate parasite, with humans serving as the natural host and reservoir. Morphologically, *C. diphtheriae* is a gram-positive, nonmotile, non-spore-forming, club-shaped bacterium that grows in characteristic branching Chinese “letter” arrangements and stains irregularly because of intracellular metachromatic (polyphosphate) granules (Barksdale, 1986; Dixon et al., 1990). Diphtheria-producing strains of *C. diphtheriae* secrete diphtheroid toxin, an extremely potent extracellular, simple protein toxin, the production of which is dictated by a prophage carrying the *tox*⁺ gene (Barksdale, 1986).

Diphtheria is normally acquired through contact with asymptomatic carriers harboring the organism in their nasal passages and only rarely by contact with actual clinical cases. In classic infections, *C. diphtheriae* multiplies within epithelial cells of the nasopharynx. Early symptoms include mild fever, sore throat, and prostration, but continued toxin production leads to formation of a tough grayish pseudomembrane composed of dead tissue and fibrin, which adheres to the tonsils and the posterior pharyngeal wall (Dixon et al., 1990; McCloskey, 1986). Subsequent spreading of this membrane downward into the larynx and trachea produces severe respiratory problems and eventual suffocation. Because all human tissues are vulnerable to this toxin, further complications including degeneration of the heart muscle, nervous system, and most other internal organs result in almost certain death once the toxin enters the bloodstream (McCloskey, 1986). Hence, neutralization of the toxin with diphtheria antitoxin at the first

suspicion of infection together with administration of penicillin or erythromycin (Dixon et al., 1990) are both vital for full recovery.

Raw milk consumption was epidemiologically linked to 11 diphtheria outbreaks in the United States between 1919 and 1948 (Bryan, 1979), with three similar outbreaks also being reported in England (Goldie and Maddock, 1943; Wilson, 1933) and Australia (Bryan, 1979) during this period. In most of these outbreaks, dairy workers who either exhibited active infections or carried *C. diphtheriae* asymptotically were assumed to have contaminated milk during milking or subsequent handling. Evidence for direct transmission of *C. diphtheriae* by cows is limited to two related cases of bovine diphtheritic mastitis in a small South African village (Pfeiffer and Viljoen, 1945) and one additional outbreak in which superficial teat and udder infections developed in cows from contact with a human carrier (Henry, 1920). Several early outbreaks also were associated with consumption of ice cream (Bryan, 1979) and butter (Hammer, 1938). More recently, 149 diphtheria cases were reported in the Arab Republic of Yemen from August 1981 to January 1982 (Jones et al., 1985). Twenty-one children died, giving a mortality rate of 14%. Subsequent epidemiological evidence implicated one commercial brand of yogurt as a possible source of infection; however, the product was no longer available for testing. The fact that most children younger than 10 years of age were not fully immunized against diphtheria was a major contributing factor in this outbreak. With the help of well-developed immunization programs, an average of only three annual cases of diphtheria was recorded in the United States from 1984 to 1994 (Anonymous, 1994c), with only one case being reported in 1998 (Anonymous, 1999). Thus, the rarity of diphtheria cases in highly industrialized countries coupled with routine pasteurization has all but eliminated dairy products as a source of *C. diphtheriae* infections.

B. Scarlet Fever and Septic Sore Throat

Streptococcus pyogenes, a gram-positive, β -hemolytic, group A streptococcus, causes scarlet fever, septic sore throat, pharyngitis, and tonsillitis in humans and mastitis in dairy cattle (Bryan, 1979). Human symptoms of infection include severe sore throat, hoarseness, headache, muscle pain, fever, prostration, weakness, chills, diarrhea, nausea, and vomiting (Decker et al., 1985). Scarlet fever, which manifests with a characteristic rash, results from infection with certain erythrogenic toxin-producing strains of *S. pyogenes*. Prompt treatment with antibiotics greatly minimizes further complications such as rheumatic fever and nephritis; however, 25% of patients who have received proper treatment can become lingering carriers of *S. pyogenes* (Valkenburg, 1986).

Dairy-related outbreaks of scarlet fever and septic sore throat were common before pasteurization became routine (Eyler, 1986), with at least 40 such outbreaks (13,939 cases and 20 deaths) occurring between 1907 and 1927; 37 of

these outbreaks presumably resulted from ingestion of raw milk (Hammer, 1938). The largest of these outbreaks occurred in Chicago, with at least 10,000 cases linked to faulty milk pasteurization (Capps and Miller, 1912). In most instances, the initial source of contamination was traced to dairy farmers with scarlet fever who either infected their cows or the milk during milking (Hammer, 1938) with subsequent growth of *S. pyogenes* also possible between 20 and 37°C (Davis, 1914). Even though a few additional outbreaks have been traced to ingestion of ice cream (Hammer, 1938), dried milk (Allen and Baer, 1944; Purvis and Morris, 1946), and most recently a processed white cheese produced in Israel (Bar-Dayan et al., 1996), routine pasteurization has virtually eliminated milk as a vehicle for scarlet fever in the United States.

C. Tuberculosis

Tuberculosis was one of the greatest scourges of humans and animals since antiquity with detailed descriptions of this disease recorded by Hippocrates in 400 BC (Grange, 1990). The turning point finally came in 1882 when Robert Koch isolated and showed *Tuberkelbacillin* (bacilli of tuberculosis) to be the causative agent of tuberculosis (Collins and Grange, 1983). Similar organisms were subsequently isolated from cases of tuberculosis-like disease in various animals, giving rise to three main types of tubercle bacilli now recognized as *Mycobacterium tuberculosis* (human type), *M. bovis* (bovine type), and *M. avium* (avian type). In 1901, Koch erroneously claimed that “the human subject is immune against infection with bovine bacilli...” and that “human tuberculosis differs from bovine, and cannot be transmitted to cattle.” In 1911, the Royal Commission on Tuberculosis concluded that cows with bovine tuberculosis indeed posed a hazard to human health (Collins and Grange, 1983). Two years later, cattle vaccinated with supposedly attenuated strains of *M. tuberculosis* were shown to shed viable virulent organisms in their milk (Griffith, 1913). Today, tuberculosis is an infectious granulomatous disease primarily acquired by inhaling *M. tuberculosis*. Dairy herd immunization programs and mandatory pasteurization virtually eliminated milkborne *M. bovis* infections in developed countries after 1960 (Habib and Warring, 1966).

1. General Characteristics

M. bovis, the primary organism responsible for milkborne tuberculosis, is an aerobic, nonmotile, non-spore-forming, nonencapsulated, straight to slightly curved, slender, weakly gram-positive, acid-fast (resistant to decolorization by acidified organic solvents after initial staining) bacillus (Nolte and Metchock, 1995). Most commonly isolated mycobacteria, including *M. bovis*, grow very slowly and may require up to 8 weeks of incubation at 35°C for visible growth

to appear on laboratory media. Inoculation of guinea pigs was historically used to identify raw milk and clinical samples containing *Mycobacterium* spp., particularly *M. bovis* (Wilkins et al., 1987). However, several rapid DNA-based methods are now available to screen milk samples for *M. bovis* (Zanini et al., 1998). Biochemically, *M. bovis* fails to produce niacin or reduce nitrate, with *M. tuberculosis* giving the reverse reactions (Nolte and Metchock, 1995). High cell wall lipid levels account for the unique resistance of the organism to drying, chemical disinfection, and other environmental stresses (Mitscherlich and Marth, 1984), which, in turn, makes *M. bovis* difficult to eradicate from farm environments.

2. Clinical Manifestations

Nonpulmonary tuberculosis is an infectious granulomatous disease characterized by development of lesions at the site of penetration, typically the oropharynx and intestinal tract in milkborne cases involving *M. bovis*. Spread of the organism to the kidneys and genitourinary tract via the lymphatic system can produce additional lesions in these areas. A condition affecting bones and joints known as kyphosis (hunchback) frequently occurs in infected older children and adults, whereas children younger than 5 years of age are most prone to complications of the meninges, including meningitis (Bryan, 1979; Hammer, 1938). Given such widespread organ involvement, prognosis was poor, with 2000 of 4000 childhood cases in Great Britain ending terminally in 1932 (Anonymous, 1932). Development of antituberculosis drugs, including isoniazid, rifampicin, and pyrazinamide, has revolutionized modern-day treatment of tuberculosis, making operative intervention and sanatoriums part of a bygone era (Grange, 1990).

3. Outbreaks

According to Park and Krumwiede (1911), *M. bovis* infections were relatively common, with this organism accounting for 7% of all tuberculosis cases observed in New York City and 9% of all such cases reported worldwide. Reports circumstantially linking raw milk consumption to tuberculosis also abound in the early literature (Bryan, 1979; Hammer, 1938); however, only three reports are supported by strong bacteriological evidence. In the first of these outbreaks (Price, 1934), *M. bovis* was recovered from raw milk consumed by 3 of 45 Canadian children in whom nonpulmonary tuberculosis developed. The second outbreak occurred in 1936 and was traced to a small Swedish village (Stahl, 1939). Milk from a cow with active tuberculosis of the udder was reportedly consumed raw by 29 of 32 individuals in whom tuberculosis developed even though the local dairy farm had a rigorous tuberculosis screening program in place at the time of the outbreak. Quinn et al. (1974) reported that a young boy living on a Michigan farm reacted positively to a tuberculin skin test after ingesting raw milk from his parents' herd of 34 dairy cows, several animals of which were heavily in-

fected. The last two cases of bovine tuberculosis within the United States were diagnosed in 1976 (Passes et al., 1978), with both victims reportedly being foreign-born and having spent much time in India.

Changing milk consumption habits, mandatory pasteurization, and cattle immunization programs have drastically reduced but probably not totally eliminated milkborne transmission of *M. bovis* tuberculosis. In the United States, *M. bovis* accounted for only 6 of 2086 culturally confirmed tuberculosis cases at the Mayo Clinic from 1950 to 1958 (Steele and Ranney, 1958). However, another survey conducted in England, Scotland, and Wales showed that 26, 22, and 17%, respectively, of nonpulmonary tuberculosis cases were caused by *M. bovis*, with many of these patients giving a history of raw milk consumption. According to Collins and Grange (1983), *M. bovis* is still of concern in nonpulmonary tuberculosis, with 109 cases being reported in southeast England (including London) from 1977 to 1981, and 1–5 cases identified annually in Ireland from 1983 to 1994 (Cotter et al., 1996). Nonetheless, the last three confirmed cases of milkborne tuberculosis in England and Wales were reported during the 1950s (Galbraith et al., 1982), which in turn suggests that potential milkborne *M. bovis* cases are being incompletely investigated or underreported (Collins and Grange, 1983).

4. Occurrence and Survival in Milk and Dairy Products

Factors influencing milkborne transmission of *M. bovis* include incidence of infection in cows as well as incidence and level of contamination in milk. *M. bovis* infections in dairy cattle are long lasting, with 1–2% of cases involving udder lesions and excretion of *M. bovis* in the milk (Stiles, 1989). However, dairy cattle also can shed *M. bovis* in their milk as a result of septicemic and cutaneous infections. In both instances, sufficient levels of mycobacteria can be excreted from a single cow to make 100 gallons of previously noncontaminated milk infectious for infants (Kleeburg, 1975). Although unable to grow in refrigerated milk, *M. bovis* persists in such milk during extended storage (Hammer, 1938). Before dairy cattle were routinely screened for tuberculosis, *M. bovis* was commonly found in raw milk, with 3–15% of the raw and pasteurized milk supplied at the turn of the last century to such cities as New York, Washington, DC, Baltimore, Philadelphia, and Chicago containing *M. tuberculosis* or *M. bovis*. During this period, an estimated 43,750 qt of contaminated milk was being pasteurized daily for the Chicago market (Hammer, 1938). Elsewhere, the situation was similar, with 8.6% of 16,700 milk samples collected worldwide yielding *M. tuberculosis* (Hammer, 1938). A tuberculosis infection rate of 40% for cattle slaughtered in 1932, 0.5% of which had mycobacteria in their milk, likely accounts for only part of this contamination (Savage, 1933), with the remainder coming from direct contact of milk with dried fecal material or the farm environment. Given the

success of tuberculosis screening programs for cattle in the United States, Canada, and western Europe, coupled with the systematic slaughter of all animals testing positive from infected herds, the incidence of *M. bovis* in the raw milk supply is very low. However, raw milk from northern India (Sakhre and Vyas, 1978) and other less developed areas of the world may harbor *M. bovis* with greater frequency.

Although clearly present in raw milk after the turn of the last century, *M. tuberculosis* (*M. bovis*) was seldom recovered from dairy products other than butter, cream cheese, and occasionally cottage cheese. Early reports indicated *M. tuberculosis* contamination rates of 9.5 and 13.2% for butter marketed in Boston (Rosenau et al., 1914) and Europe (Hammer, 1938), respectively, with the organism surviving at least 153 days in butter prepared from naturally contaminated cream (Mitscherlich and Marth, 1984). In addition, *M. tuberculosis* was present in 13.7% of cream cheese and 3.2% of cottage cheese marketed in Washington, DC (Schroeder and Brett, 1918). Although *M. bovis* is seldom found in other dairy products, numerous early studies attest to the hardiness of *M. bovis* in other cheeses, reportedly surviving at least 47 days in Camembert and Muenster cheese as well as 62 days in Cheddar cheese and 232 days in Tilsit cheese (Mitscherlich and Marth, 1984), all of which were prepared from naturally contaminated milk. In a more recent survey, Obiger et al. (1970) failed to recover *M. tuberculosis* from 51 soft French cheeses, many of which were likely prepared from raw milk. Consequently, these latter findings combined with a complete lack of cheese-associated cases suggest that cheese is an unlikely vehicle for *M. bovis* infections.

5. Prevention

Veterinary inspection of meat and tracing of infected animals back to their farm of origin, coupled with systematic slaughter of tuberculosis-positive animals in the herd, have greatly reduced the incidence of tuberculosis in dairy cattle. In 1979, only 0.18% of the herds in Great Britain were found to be positive for tuberculosis (Collins and Grange, 1983). However, because certain wild animals, including deer, racoons, badgers and opossums, are also susceptible to *M. bovis* infections, total eradication of tuberculosis in dairy cattle is unlikely in the United States and elsewhere, with dairy cows sporadically testing positive for *M. bovis* in northern lower Michigan. Mandatory pasteurization, the other step in preventing milkborne tuberculosis, has proven to be highly effective with high-temperature, short-time (71.7°C for 15 s), and vat pasteurization (61.7°C for 30 min), both inactivating large populations of *M. bovis* and *M. tuberculosis* in milk with a wide margin of safety (Kells and Lear, 1960). However, as discussed earlier (Quinn et al., 1974), bovine tuberculosis may still present an occasional health risk, particularly for individuals consuming raw milk on farms or cheeses prepared from raw milk.

D. Typhoid Fever

Raw milk was first suggested as a vehicle for typhoid fever well before the etiological agent was isolated and identified. In 1857, Dr. Michael Taylor of Penrith, England, identified 13 cases of typhoid fever among seven rural families who obtained raw milk from a family farm (Hammer, 1938). Epidemiological evidence suggested that a servant girl suffering from typhoid fever was most likely responsible for contaminating the milk in this outbreak. The causative agent of typhoid fever, later named *Salmonella* Typhi, was not observed in human patients until 1880, and the organism was isolated on culture media 4 years later (Bryan et al., 1979; Marth, 1969). During the first half of the 20th century, consumption of contaminated milk, cheese, and butter was responsible for numerous outbreaks of typhoid fever and many fatalities, with the disease accounting for 50–80% of all cases of milkborne illness reported in the United States from 1900 to 1939 (Bryan, 1983; Hammer, 1938). However, adoption of routine pasteurization of milk after World War II and improvements in sanitation standards led to a precipitous decrease in typhoid fever with no milkborne outbreaks being reported in the United States since the 1950s. Whereas milkborne typhoid fever has been eradicated in most industrialized countries, occasional milkborne outbreaks still occur in developing countries where the disease is endemic because of contaminated water supplies.

1. General Characteristics

S. Typhi, an important bacterium in the family Enterobacteriaceae, is short, motile, gram-negative, facultatively anaerobic and rod shaped (Kuesch, 1986). *S. Typhi* readily grows on common laboratory media at 15–41°C, with optimal growth occurring at 37°C. This serovar of *Salmonella* is biochemically distinct from the more than 2300 other serovars of salmonellae that are responsible for gastroenteritis, the most common form of *Salmonella* infection. Isolates of *S. Typhi* do not produce gas from glucose, utilize citrate, decarboxylate ornithine, or ferment rhamnose. In contrast to other salmonellae that are found in the gastrointestinal tract of many animals, humans are the only known reservoir for *S. Typhi*. The closely related organism *Salmonella* Paratyphi, which causes paratyphoid fever, rarely produces mastitis in dairy cattle (George et al., 1972) and is almost invariably confined to human carriers. However, both organisms are extremely hardy and can survive many weeks in water, ice, feces, and dust particles (Mitscherlich and Marth, 1984), which makes their elimination from the environment difficult.

2. Clinical Manifestations

Typhoid fever normally begins with a bacteremia-related fever that develops 1–2 weeks after ingesting at least 10^5 *S. Typhi* organisms (Kuesch, 1986; Parker,

1990). Various nonspecific symptoms, including anorexia, malaise, lethargy, myalgia, and a continuous headache, frequently accompany the fever, which peaks at 104–105°F (40–41°C) within 3–4 days. Although some patients experience spontaneous remission of these symptoms within 1 week, sustained high fever over the ensuing 2 weeks most often leads to frank prostration, delirium, and abdominal pain caused by spleen or liver enlargement. A bewildering array of typhoid-related complications ranging from encephalitis, Guillain-Barré syndrome, and psychiatric disorders to myocarditis, hepatitis, nephritis, hemolytic uremic syndrome, osteomyelitis, and septic arthritis has also been reported. Two prominent complications during the third week of infection, namely intestinal hemorrhage and perforation of the bowel, can lead to peritonitis, which is usually fatal without surgical intervention. Prompt antimicrobial therapy has reduced the mortality rate of typhoid fever in the United States and other developed countries to less than 1%, with chloramphenicol being the antibiotic of choice. Despite proper treatment, 90% of patients shed *S. Typhi* in their feces for up to 3 months. Furthermore, approximately 3% of patients become long-term (>1 year) excretors of *S. Typhi* at levels of at least 10⁶ organisms/g, as was true for the infamous “Typhoid Mary,” with such individuals serving to spread the organism to other humans and perpetuate the infectious cycle.

3. Outbreaks

Before 1940, *S. Typhi* was responsible for 50–80% of all milkborne illnesses reported in the United States (Bryan, 1983), with a total of 848 typhoid fever outbreaks involving more than 30,000 cases and 300 deaths being recorded (Hammer, 1938). Milkborne epidemics peaked in the United States during 1911–1915 with 238 reported outbreaks, most of which involved *S. Typhi*. According to Armstrong and Parran (1927), of 479 milkborne outbreaks of typhoid fever summarized up to 1927, 444 (93%) and 32 (6.5%) were linked to milk (primarily raw) and ice cream, respectively, with the three remaining outbreaks involving butter and cheese. Only 29 outbreaks were traced to pasteurized milk or dairy products, with *S. Typhi* entering the product as a postpasteurization contaminant. Symptomatic and asymptomatic carriers of *S. Typhi* were identified as the contamination source in 80% of these outbreaks with milk bottles coming from infected households and use of polluted water to clean dairy utensils cited as additional contributing factors.

Many of these early epidemics involving milk, butter, and cheese have been well documented. In one outbreak in 1900, 65 college students became ill after consuming raw milk (Hammer, 1938). Investigators traced the milk to a farm worker who had recently recovered from typhoid fever. Use of badly polluted well water to wash dairy equipment and temperature abuse of the milk were cited as major contributing factors. During the 1920s, one particularly large outbreak

of typhoid fever was traced to pasteurized milk in Montreal, Canada. A total of 5014 cases and 488 deaths occurred primarily among institutionalized children and adults, giving a mortality rate of nearly 10% (Lumsden et al., 1927). Faulty pasteurization, intentional addition of raw milk to pasteurized milk, and handling of milk by an infected worker were cited as probable causes. Butter contaminated by a convalescent carrier of *S. Typhi* was responsible for 35–40 cases (including six deaths) of typhoid fever in Minnesota during 1913 (Hammer, 1938). The cheeseborne outbreak alluded to earlier occurred during 1923 and involved 51 cases of typhoid fever (including four deaths) in Michigan (Rich and Fellow, 1923). Raw milk used in cheese making was reportedly contaminated by a farm worker shedding *S. Typhi* with the cheese being consumed shortly after manufacture. During the 1940s, three additional Canadian outbreaks of typhoid fever were traced to Cheddar cheese prepared from contaminated raw milk and consumed before 60 days of ripening (Foley and Poisson, 1945; Gauthier and Foley, 1943; Menzies, 1944). Colby and mold-ripened cheeses also have been implicated in outbreaks of typhoid fever according to Marth (1969).

Routine pasteurization of milk and improved sanitary standards led to a precipitous decrease in the number of typhoid cases and human carriers of *S. Typhi* after World War II, with typhoid fever being responsible for only 17 and 3% of all dairy-related illnesses reported in the United States during 1940–1949 and 1950–1959, respectively (Bryan, 1983). As a result of these efforts, the annual number of typhoid fever cases from all causes decreased from 4211 cases in 1945 to 375 cases in 1998 (Anonymous, 1999), with no dairy-related cases of typhoid fever being reported in the United States since the 1950s. As recently as 1971, however, officials at the Centers for Disease Control traced 132 cases of typhoid fever in Trinidad to commercially produced ice cream with an infected factory worker and absence of pasteurization cited as the most likely causes (Taylor et al., 1974). Hence, milkborne typhoid fever can still pose a threat in developing countries where substandard sanitation can lead to substantial numbers of *S. Typhi* carriers.

4. Occurrence and Survival in Milk and Dairy Products

Contamination of raw milk, pasteurized milk, and other dairy products has been invariably linked to symptomatic or asymptomatic carriers of *S. Typhi*. Scott and Minett (1947) produced mastitis in dairy cows by injecting *S. Typhi* into the udder, and the organism was subsequently shed in the milk for up to 85 days. Given the absence of any naturally occurring cases of bovine mastitis involving the shedding of *S. Typhi* in milk, however, contamination of all dairy products is assumed to be exclusively of human origin. Even without survey data, because there is an absence of recent milkborne cases of typhoid fever and because fewer than 700 cases of typhoid fever from all causes have been reported in the United

States since 1965 (Anonymous, 1994c), it is suggested that *S. Typhi* has been eliminated from the milk supply and other dairy products.

Current vat and high-temperature, short-time pasteurization standards are designed to destroy large populations of *S. Typhi* in milk with a wide margin of safety (Evans and Litsky, 1968). However, this pathogen will readily grow as a postpasteurization contaminant in pasteurized and sterilized milk that has been temperature abused (Pullinger and Kemp, 1938) and persists in refrigerated milk for 3–6 weeks (Mitscherlich and Marth, 1984). According to results from several additional early studies summarized by Mitscherlich and Marth (1984), *S. Typhi* can survive 2–4 weeks in butter prepared from contaminated cream and also persists 12–39 days in ice cream stored at -4 to -5°C . These findings clearly support milk, butter, and ice cream as vehicles of infection in the aforementioned outbreaks.

The fate of *S. Typhi* both on and in cheese also has attracted some attention. Early reports indicated that *S. Typhi* survived approximately 2–4 and 10–15 weeks after Cheddar, Swiss, and other cheeses were surface inoculated and stored at ambient and refrigeration temperatures, respectively (Mitscherlich and Marth, 1984). When Cheddar cheese was prepared from inoculated milk and ripened at 15 and 5°C , *S. Typhi* generally persisted for 3 months and at least 10 months, respectively (Campbell and Gibbard, 1944). In addition, Wade and Shere (1928) found that *S. Typhi* survived 2–3 months in Cheddar cheese prepared from naturally contaminated milk that would not clot properly. Such findings led to the present law requiring that Cheddar and other hard cheeses legally prepared from raw or subpasteurized milk be held at greater than or equal to 1.7°C for at least 60 days to eliminate *S. Typhi* and other pathogenic bacteria.

5. Prevention

With modern sewage treatment plants and dairy processing facilities, milkborne typhoid fever is no longer a threat in industrialized countries, and no such cases have been reported in the United States or England during the past 40 years (Galbraith et al., 1982). However, the potential for milkborne outbreaks still exists in developing countries where typhoid fever is endemic because of high human carriage rates for *S. Typhi*. Consequently, travelers to such areas should be appropriately vaccinated and avoid consuming raw milk and dairy products prepared under poor sanitary conditions.

III. CURRENT PUBLIC HEALTH CONCERNS

Public health concerns impacting on the dairy industry continue to change in response to advances in sanitation, milk handling, and animal husbandry prac-

tices. Common pre–World War II milkborne illnesses such as diphtheria, scarlet fever, tuberculosis, and typhoid fever no longer pose a significant threat to consumers and have been replaced by more immediate concerns. Milkborne staphylococcal poisoning, a major problem during the middle of the last century, has been superseded in importance by salmonellosis and campylobacteriosis, which have accounted for most dairy-related illnesses reported since the early 1980s. Although responsible for comparatively few outbreaks of illness, several recently identified milkborne pathogens, including *E. coli* O157:H7 and *L. monocytogenes*, have received widespread attention because of the particularly severe or fatal complications produced by these organisms. The potential impact of aflatoxin—a highly potent human carcinogen sometimes found in milk—has also received recent attention, as have the possible public health ramifications of antibiotic and drug residues in the milk supply. Finally, several recent reports suggest that milkborne brucellosis is of more than passing interest, particularly in the southwestern United States. Although definition of a “major public health concern” is somewhat arbitrary, 12 major public health concerns impacting on the dairy industry since World War II are discussed in this section based on their continued high incidence of disease (e.g., campylobacteriosis, salmonellosis, staphylococcal poisoning), recurring sporadic outbreaks (*Bacillus cereus* poisoning, brucellosis, enteropathogenic *E. coli*), severity of illness (botulism, *E. coli* O157:H7, listeriosis, yersiniosis), and potential impact of chronic exposure (aflatoxin, drug residues). These major public health concerns account for more than 95% of all reported milkborne illnesses.

A. Aflatoxin

The aflatoxins belong to a subset of secondary metabolites termed mycotoxins, which are produced by certain strains of molds; namely, *Aspergillus flavus*, *A. parasiticus*, and *A. nomius*. First identified in England in 1960 during an outbreak that involved the death of more than 100,000 turkeys from liver disease (Stevens et al., 1960), the aflatoxins have become recognized as extremely potent liver carcinogens for both animals and humans. Four major forms of aflatoxin, designated aflatoxin B₁ (AFB₁), B₂ (AFB₂), G₁ (AFG₁), and G₂ (AFG₂), are currently recognized, with AFB₁ being the most potent (Applebaum et al., 1982). AFB₁ is most often found in moldy peanuts (ground nuts) and animal feeds containing corn or other grains. When dairy cattle ingest contaminated feed, AFB₁ is metabolized to aflatoxin M₁ (AFM₁), some of which is shed in the milk (see Chap. 1). Animal feeding studies indicate that AFM₁ is somewhat less carcinogenic than AFB₁. As of 1997, at least 66 countries had active or proposed legislation regarding aflatoxin limits in foods (Cerutti and Campiglio 1997), with the United States and countries of the European Union having legislated maximum acceptable

AFM₁ levels of 0.5 and 0.1 ppb in fluid milk and milk destined for infant foods, respectively (Anonymous 1999).

1. General Characteristics

Aflatoxins, named because of their production by the mold *A. flavus* (*A. flavus toxin*), are highly substituted coumarins containing a fused dehydrofurofuran moiety. These toxic and carcinogenic secondary metabolites form a unique group of highly oxygenated, heterocyclic, low molecular weight compounds. Four major aflatoxins are recognized, with AFB₁ and AFB₂ exhibiting intense blue fluorescence and AFG₁ and AFG₂ exhibiting intense green fluorescence when viewed under ultraviolet light at 425 and 450 nm, respectively (Applebaum et al., 1982). Relatively few *A. flavus* and *A. parasiticus* isolates produce aflatoxin. However, toxigenic strains typically synthesize two or three forms of aflatoxin, one of which is invariably AFB₁—the most potent toxin and carcinogen of the group. When dairy cattle ingest aflatoxin-contaminated feed, AFB₁ and AFB₂ are metabolized to their respective 4-hydroxy derivatives, namely, AFM₁ and AFM₂, and excreted with milk. AFM₁ is of primary concern to the dairy industry, whereas AFM₂ is produced in smaller quantities and is far less toxic than AFM₁.

Requirements for aflatoxin synthesis are relatively nonspecific, with these secondary metabolites being produced on most foods and laboratory media that support mold growth. *A. flavus* and *A. parasiticus* fail to produce aflatoxins when grown at temperatures below 7.5°C or above 40°C, with 7–21 days of incubation at 25–30°C optimal for aflatoxin synthesis (Schindler, 1977). However, aflatoxin production is reportedly enhanced when temperatures fluctuate between 5 and 25°C (Park and Bullerman, 1981). Levels of AFM₁ in milk and dairy products are minimally affected by pasteurization, sterilization, fermentation, cold storage, freezing, concentrating, or drying (Aman, 1995; Yousef and Marth, 1989). However, treating milk with hydrogen peroxide, benzoyl peroxide, sulfites, bisulfites, riboflavin, lactoperoxidase, or ultraviolet irradiation has proven to be effective in experimentally reducing levels of AFM₁ in contaminated milk (Applebaum and Marth, 1982a; Yousef and Marth, 1985, 1986). AFM₁ levels in milk also can be markedly reduced by physically adsorbing the toxin onto certain particulate materials such as bentonite (Applebaum and Marth, 1982b).

2. Detection

Several methods based on thin-layer chromatography (TLC) and more recently high-performance liquid chromatography (HPLC) are available for detecting AFM₁ in milk and dairy products (Scott, 1990; Stubblefield and van Egmond, 1989). Regardless of the method used, AFM₁ must first be extracted from the sample either directly using chloroform or indirectly from columns on which

AFM₁ has been adsorbed using more polar solvents such as methanol and acetonitrile. After further purification by solvent partition column chromatography or dialysis (Diaz et al., 1993), the extract is analyzed by one- or two-dimensional TLC on silica gel plates with the latter being the Association of Official Analytical Chemists (AOAC)-approved method preferred for samples likely to contain less than 0.1 µg AFM₁/kg. However, an alternative method using an immunoaffinity column clean up followed by reverse-phase HPLC is equally sensitive and has superseded two-dimensional TLC in many laboratories (Dragacci and Fremy, 1996). After ultraviolet detection at 365 nm, positive results can be confirmed by rechromatographing the sample after trifluoroacetic acid derivitization and inspecting the chromatogram for specific end products.

More recently, immunochemical strategies have been developed for detecting AFM₁ in milk and milk products (Fremy and Chu, 1989). Polyclonal and monoclonal antibodies produced by conjugating AFM₁ to a protein before injection into rabbits have been adapted for use in radioimmunoassays (Sun and Chu 1977) and more recently enzyme-linked immunosorbent assays (Candlish et al., 1985; Fremy and Chu, 1984) following extraction of AFM₁ from the product in question. Several of these newer immunochemical methods have received AOAC approval.

3. Clinical Importance

Concern regarding human exposure to aflatoxin is based on results from animal feeding trials. Acute toxicity of aflatoxin is well documented in laboratory animals, with 50% of 1-day-old ducklings dying after receiving single doses of AFB₁, AFG₁, AFB₂, and AFG₂ at levels of 0.73, 1.18, 1.76, and 2.83 mg/kg body weight, respectively (Wogan et al., 1971). Gross liver failure is the normal cause of death in animal studies involving acute oral exposure to AFB₁. Long-term exposure to low levels of AFB₁ (i.e., 1 ppm) in feed usually leads to terminal liver cancer with mutagenic and teratogenic effects also being widely recognized.

Studies assessing the toxicity of AFM₁ are far fewer because of limited availability of AFM₁ in pure form. Allcroft and Carnaghan (1963) were first to report that milk from cows that received aflatoxin-contaminated feed produced liver lesions and kidney damage in day-old ducklings. Pathological changes in the liver also were similar to those produced by AFB₁. According to Pong and Wogan (1971), AFM₁ was lethal to laboratory rats at a dose of 1.5 mg/kg body weight, with death again resulting from acute liver failure. Overall, the hepatotoxicity of AFM₁ in ducklings and rats appears to be similar or slightly less than that of AFB₁.

Like AFB₁, AFM₁ is also a potent liver carcinogen. In early feeding studies using rainbow trout, Sinnhuber et al. (1974) found that 60% of fish on a continuous diet of 20 µg AFM₁/kg body weight developed liver carcinomas within 12

months. In another study by Cullen et al. (1985), four groups of laboratory rats were maintained on diets containing 0, 0.5, 5, and 50 $\mu\text{g AFM}_1/\text{kg}$ with a fifth control group receiving 50 $\mu\text{g AFB}_1/\text{kg}$. Hepatocarcinomas developed in only 5% of rats receiving 50 $\mu\text{g AFM}_1/\text{kg}$, whereas liver cancers were detected in 95% of the AFB_1 control group. Thus, AFM_1 appears to possess only about 5% of the hepatocarcinogenic potential when compared to AFB_1 . Based on studies using rhesus monkeys (Seiber et al., 1979), the carcinogenic potential of AFM_1 in humans is likely 10- to 100-fold less than that of AFB_1 .

4. Occurrence and Fate in Dairy Products

Ingestion of aflatoxin-contaminated animal feed leads to the excretion of AFM_1 in milk within 12–24 h (van Egmond, 1989a). However, only 0.4–2.2% of ingested AFB_1 appeared in milk as AFM_1 (Frobish et al., 1986; Patterson et al., 1980). Levels of AFM_1 normally peak within 3–6 days and decrease to undetectable levels 2–4 days after exposure to contaminated feed is stopped. Assuming that 6 kg of feed containing 10 $\mu\text{g AFB}_1/\text{kg}$ is consumed daily, dairy cows should produce milk containing 0.02–0.07 $\mu\text{g AFM}_1/\text{L}$ (van Egmond, 1989b). However, AFM_1 levels in milk fluctuate daily and vary between animals (Kiermeier et al., 1977; Patterson et al., 1980; Veldman et al., 1992).

Milk surveillance programs for AFM_1 have been conducted in the United States and elsewhere. During the fall of 1977, 43–80% of milk samples collected in Alabama, Georgia, North Carolina, and South Carolina contained a trace to greater than 0.7 $\mu\text{g AFM}_1/\text{L}$, with a heavily contaminated corn crop being largely responsible (Stoloff, 1980). Although the AFM_1 contamination rate has since subsided, a similar peak in AFM_1 -positive milk samples was again observed in late 1988 and early 1989 (van Egmond, 1989b), with a midsummer drought being blamed for high levels of AFB_1 in midwestern feed corn. More recently, high levels of aflatoxin also forced a Georgia dairy to recall more than 24,000 gal of pasteurized dairy products during January of 1991 (Anonymous, 1991c).

In European surveys conducted during the late 1960s and 1970s, 11–82% of the milk samples examined contained AFM_1 at levels of 0.2–6.5 $\mu\text{g}/\text{kg}$, with fewer positive milk samples being recorded during the summer grazing period (van Egmond, 1989b). Legislative action regarding maximum acceptable aflatoxin levels, typically less than 0.5 $\mu\text{g}/\text{kg}$, has led to marked reductions in AFM_1 contamination levels, with less than 25% of samples from Austria, Belgium, Finland, France, Greece, Ireland, Italy, Poland, Spain and the United Kingdom normally containing AFM_1 , mostly at very low levels. (Domagala et al., 1997; Food Surveillance Information Sheet, 1996; Galvano et al., 1998; Markaki and Melisari, 1997).

Sporadic contamination of the milk supply has raised concerns regarding the fate and stability of AFM_1 during manufacture and storage of both nonfer-

mented and fermented dairy products. Despite some variability in data reviewed by Yousef and Marth (1989), the level and activity of AFM₁ in milk does not appear to change appreciably as a result of pasteurization, sterilization, cold storage, or freezing. Although AFM₁ is concentrated in nonfat dry milk, evaporated milk, and freeze-dried milk during manufacture, the stability and activity of AFM₁ is again relatively unaffected during concentration and drying. Because AFM₁ is primarily water soluble, a natural partitioning of AFM₁ also occurs during production of cream and butter. Typically, only approximately 10 and 2% of the AFM₁ in milk appears in cream and butter, respectively, with the remainder being shed in the two by-products—skim milk and buttermilk.

When cheeses such as Cheddar (Brackett and Marth, 1982b), Swiss (Stubblefield and Shannon, 1974), Parmesan (Brackett and Marth, 1982c), and Camembert (Kiermeier and Buchner, 1977) are prepared from AFM₁-contaminated milk, the toxin partitions almost equally between the curd and whey, with the higher than expected levels in curd presumably resulting from selective hydrophobic adsorption to casein. The end result is that AFM₁ levels in soft and hard cheese are normally 2.5- to 3.3- fold and 3.9- to 5.8-fold higher, respectively, as compared with original levels in the cheese milk (Yousef and Marth, 1989). Little, if any, change in AFM₁ activity has been reported during cheese making or ripening. However, proteolysis of casein during extended storage tends to increase levels of AFM₁ detected (Brackett and Marth, 1982a).

In addition to AFM₁-contaminated milk, growth of naturally occurring aflatoxigenic molds on the surface of cheese is also of some public health concern, because aflatoxin-positive cheeses have been detected during surveys in the United States, western Europe, and north Africa. (Barrios et al., 1996, 1997; Piefri et al., 1997; Scott, 1989). In several surface mold inoculation studies, AFB₁ and AFG₁ diffused at least 4 cm into the cheese during storage (Park and Bullerman, 1983; Shih and Marth, 1972). Hence, simply scraping the mold from the cheese surface does not necessarily render the product safe for consumption.

5. Prevention

Minimizing the presence of AFM₁ in milk and dairy products is entirely dependent on careful control and monitoring of mold growth and AFB₁ levels in animal feed. The United States requirement of less than or equal to 20 ng total aflatoxin per gram of animal feed, if observed, will consistently yield acceptable milk containing less than 0.5 ng (0.5 ppb) AFM₁/g.

B. *Bacillus cereus* Food Poisoning

Aerobic, spore-forming bacteria resembling *B. cereus* have been suspected as being agents of foodborne disease for many years, with at least six ‘‘*B. cereus*–

like'' outbreaks in Europe described before 1950 (Gilbert, 1979; Kramer and Gilbert, 1989). However, early recognition of pathogenic bacilli other than *B. anthracis*—the causative agent of anthrax—was not possible because of considerable taxonomic confusion in the genus *Bacillus*. Realization that *B. cereus* was a foodborne pathogen came in the early 1950s when the Norwegian investigator Hauge (1950, 1955) described a series of four outbreaks involving 600 cases of diarrheal illness that were traced to consumption of vanilla sauce prepared from corn starch heavily contaminated with *B. cereus*. Even though the role of *B. cereus* in this outbreak was proven in human volunteer feeding studies, conclusive findings concerning direct involvement of two different toxins, namely, diarrheal enterotoxin (Goepfert et al., 1972; Spira and Goepfert, 1972) and emetic enterotoxin (Melling et al., 1976), in two distinct forms of *B. cereus* poisoning were not reported until the 1970s.

A common contaminant of the dairy environment and raw milk supply, *B. cereus* also is one of several spoilage organisms responsible for "sweet curdling" (Overcast and Atmaram, 1974) and "bitty cream" (Cox, 1975). Despite the ability of this spore-forming organism to germinate and grow in refrigerated milk, most recent outbreaks of *B. cereus* food poisoning in the United States (Bean et al., 1996) and elsewhere (Kramer and Gilbert, 1989) have involved an entirely different product, namely, Chinese food (primarily fried rice), with fewer than 10 cases being traced to dairy products (i.e., nonfat dry milk, cream, ice cream) consumed in the United States (Holmes et al., 1981) and England (Galbraith et al., 1982; Sockett, 1991). However, the ability of *B. cereus* to persist in powdered milk and grow in the reconstituted product, as evidenced by a large outbreak in Chile involving newborn infants (Cohen et al., 1984), has led to establishment of rigid international standards for *B. cereus* in infant formula (Becker et al., 1994).

1. General Characteristics

A member of the genetically diverse genus *Bacillus*, which contains more than 60 different species of aerobic and facultatively anaerobic, gram-positive, spore-forming rods, *B. cereus* is larger than most other bacilli and also normally motile by peritrichous flagella (Drobniowski, 1993; Kramer and Gilbert, 1989; Sneath, 1986). Endospores are produced in either a central or near-central position and do not distend the sporangium. Unlike most other organisms discussed in this chapter, *B. cereus* is a psychrotroph and therefore able to grow at temperatures of 50°C to as low as 4°C (Dufrenne et al., 1995; Jaquette and Beuchat, 1998; van Netten et al., 1990), with growth also occurring over a pH range of 4.4–9.3 and at a water activity (a_w) of 0.92 in the presence of 7% NaCl. Typical isolates grow both aerobically and anaerobically, reduce nitrate to nitrite, liquify gelatin, hydrolyze casein and starch, utilize citrate, and produce a positive Voges-

Proskauer reaction, with acid also being produced from glucose, fructose, maltose, sucrose, salicin, trehalose, and glycerol; however, numerous exceptions have been noted. Lecithinase activity, coupled with the inability to utilize mannitol and resistance to polymyxin B, is most often used to identify suspect colonies during primary isolation.

B. cereus normally produces several types of toxins including hemolysins, proteases, phospholipases, cytotoxins (Christiansson et al., 1989), a heat-labile diarrheal enterotoxin, and a heat-stable emetic toxin, the last two of which are responsible for two distinct forms of food poisoning. Despite these many characteristics, *B. cereus* is closely related to two other prominent bacilli, namely, *B. anthracis* (the causative agent of anthrax) and *B. thuringiensis* (a well-known insect pathogen), as shown by DNA hybridization studies. It is therefore often difficult positively to identify. Thus far, 23 of 42 flagellar (H) *B. cereus* serotypes have been linked to illnesses, with biotyping (based on biochemical properties), phage typing, pyrolysis mass spectroscopy, and whole-cell fatty acid analysis profiles proving to be useful in subtyping isolates obtained during epidemiological investigations (Drobniewski, 1993; Lin et al., 1998; Valsanen et al., 1991).

2. Analysis of Dairy Products for *B. cereus* and Toxin

Most outbreaks of *B. cereus* poisoning have been traced to foods containing at least 10^6 organisms/g. However, products such as nonfat dry milk frequently contain small numbers of *B. cereus* spores, which can germinate when the milk is reconstituted and grow to dangerous levels during storage.

When large numbers of *B. cereus* are expected, the suspect food is serially diluted and surface plated on mannitol-egg yolk-polymyxin agar (MYP). Alternatively, a three-tube most probable number (MPN) method using trypticase soy-polymyxin broth can be used for samples suspected of containing low levels of *B. cereus*, with tubes showing growth similarly surface plated to MYP after 48 h of incubation at 30°C (Harmon et al., 1992; Rhodehamel and Harmon, 1995). Presumptive *B. cereus* isolates on MYP after 24–48 h of incubation at 30°C appear as large, spreading, pink (mannitol-negative) colonies surrounded by an opaque halo indicating lecithinase activity. Selected isolates are then purified and confirmed as *B. cereus* based on anaerobic production of acid from glucose, nitrate reduction, tyrosine decomposition, resistance to lysozyme, and a positive Voges-Proskauer reaction. Tests for motility, rhizoid growth, hemolysin production, and intracellular toxin crystals are also useful in differentiating the various groups of *B. cereus* from *B. thuringiensis* and *B. anthracis*. Confirming an outbreak of *B. cereus* poisoning is also dependent on demonstrating that the suspect isolate is toxigenic. Rapid assays for detecting the emetic toxin are not yet available, and current methods rely on monkey feeding trials and in vitro cell culture systems (Drobniewski et al., 1993; Wong et al., 1988). However, a serologically based

microslide gel double-diffusion assay has been developed for *B. cereus* strains producing the diarrheal form of enterotoxin (Bennett, 1995), with several fluorescent-based immunoblot (Baker and Griffiths, 1995; Granum et al., 1993), reverse passive latex agglutination assays (Granum et al., 1993; Griffiths, 1990), and visual immunoassays (Odumeru et al., 1997) also being available commercially.

3. Clinical Manifestations

B. cereus is responsible for two distinct clinical syndromes of long and short onset, both of which have involved dairy products. The so-called “diarrheal syndrome” resembles *Clostridium perfringens* food poisoning and results from a proteinaceous, heat-labile diarrheal enterotoxin that is presumably produced during growth of *B. cereus* within the small intestine (Donta, 1986; Drobniowski, 1993; Kramer and Gilbert, 1989). However, the precise mode of action of this enterotoxin remains unclear. Within 8–16 h after ingesting a food containing greater than or equal to 10^6 *B. cereus* cells/g, patients typically have abdominal pain and cramps followed by a profuse watery diarrhea devoid of blood or mucus occurring at 15- to 30-min intervals. Vomiting and fever are normally absent. The entire illness is self-limiting, usually resolving within 12–24 h without complications. The second syndrome caused by *B. cereus*, termed “emetic syndrome,” results from ingesting a heat-stable (90 min/126°C) emetic toxin, which is preformed in the food and resistant to proteolysis. This syndrome resembles staphylococcal poisoning in both symptoms and incubation period. After an onset time of 15 min to 5 hs, nausea, vomiting, abdominal cramps, and less frequently diarrhea develop, with these symptoms resolving within 1–5 h. Because both syndromes are, by definition, intoxications of short duration, antibiotic therapy is contraindicated and treatment is limited to fluid replacement and, in severe cases, administration of antiemetics.

4. Outbreaks

As discussed, few dairy-related outbreaks of *B. cereus* poisoning have been reported. The largest known of such outbreaks occurred in the Netherlands during the late 1980s when nausea and diarrhea developed in 280 individuals 2–14 h after consuming pasteurized milk containing 4×10^5 enterotoxigenic *B. cereus* colony-forming units per milliliter (cfu/mL) (van Netten et al., 1990). Except for a few scattered cases traced to feta cheese in Canada (Schmitt et al., 1976), pasteurized cream in England (Galbraith et al., 1982; Gilbert and Parry, 1977), milk in Romania (Gilbert, 1979), and ice cream in both England (Sockett, 1991) and the former Soviet Union (Gilbert, 1979), most of the remaining outbreaks have been small and typically linked to contaminated nonfat dry milk used as an ingredient. Such reported outbreaks have involved Dutch vanilla pudding (Gilbert and Parry, 1977), a Norwegian yellow pudding dessert (Pinegar and Buxton,

1977), Hungarian cream pastries (Pinegar and Buxton, 1977), and English “vanilla slice” pastries (Pinegar and Buxton, 1977). Three additional cases of *B. cereus*-like food poisoning in Canada also have been attributed to use of nonfat dry milk and malted milk powder as ingredients in unspecified home-prepared foods (Schmitt et al., 1976).

Only one dairy-related outbreak of *B. cereus* poisoning has been reported in the United States since this illness was first discovered in the early 1950s. According to Holmes et al. (1981), the emetic form of *B. cereus* poisoning developed in eight individuals in Alabama after consuming macaroni and cheese at a cafeteria. Investigators found that some of the product not served contained 10^8 – 10^9 *B. cereus* cfu/g, with the organism also being identified in powdered milk, an ingredient used in preparing the macaroni and cheese. Improper heating and refrigeration were deemed to be responsible for growth of *B. cereus* in the final product before serving. One additional unusually large outbreak occurred in Chile during May and June of 1981 when 35 neonatal cases of *B. cereus* diarrheal syndrome were traced to infant formula prepared from contaminated powdered milk (Cohen et al., 1984). Growth of *B. cereus* in infant formula during 12 and 24 h of refrigerated storage was subsequently confirmed. Follow-up studies using suckling mice demonstrated that selected isolates were enterotoxigenic. The fact that virtually all isolates were nontypeable further supports powdered milk as being the source of *B. cereus* in this outbreak.

5. Occurrence and Survival in Dairy Products

Psychrotrophic spore-forming organisms belonging to the genus *Bacillus* are common contaminants of raw milk produced in the United States and elsewhere. Spores of *B. cereus* most often enter milk from soil, feces, bedding, cattle feed, milking equipment, or udder during milking (Crielly et al., 1994; Giffel and Beumer, 1998). However, *B. cereus* also can be shed in cow's milk as a result of mastitis (Horvath et al., 1986; Logan, 1988). One survey of raw milk from Wisconsin demonstrated that 9% of the samples contained *B. cereus* at levels less than or equal to 100 cfu/g (Ahmed et al., 1983a). Working in Scotland, Griffiths and Phillips (1990) found psychrotrophic *Bacillus* spp. in 58% of the raw milk supply. In addition, 39% of the isolates were identified as being *B. cereus*, most of which produced diarrheal toxin (Griffiths, 1990). During a 2-year survey in England, Crielly et al. (1994) also noted that *B. cereus* was more commonly recovered from raw milk during the summer months at levels as high as 10^5 cfu/mL, with similar observations also being made by other investigators (McKinnon and Pettipher, 1983). Because *B. cereus* spores do not germinate in raw milk, rapid growth of vegetative cells during periods of temperature abuse is presumably responsible for the high incidence of this organism in summer milk (Larson and Jorgensen, 1996; Phillips and Griffiths, 1986).

Given the frequency of *B. cereus* in raw milk and the ability of *B. cereus* spores to survive pasteurization and germinate (Stadhouders et al., 1980), it is not surprising that this organism is also a common contaminant of pasteurized milk. According to Ahmed et al. (1983a), 35% of pasteurized milk samples sold in Wisconsin contained *B. cereus* at levels less than or equal to 1000 cfu/mL. Elsewhere, the incidence of *B. cereus* in pasteurized milk is reportedly 2% in China (Wong et al., 1988), <10% in Canada (Lin et al., 1998), 25–40% in the Netherlands (Giffel et al., 1996; van Netten et al., 1990), 33% in Australia (Rangasamy et al., 1993), and 56% in Denmark (Larsen and Jorgensen, 1996), with levels generally being less than 1000 cfu/mL. Pasteurized milk is an excellent source of enterotoxigenic strains with 59, 76, and 100% of milk isolates from Norway (Granum et al., 1993), the Netherlands (Giffel et al., 1996), and Scotland (Griffiths, 1990), respectively, producing toxins. Furthermore, Odumeru et al. (1996) reported that 43 of 112 (38%) retail samples of Canadian pasteurized milk were positive for *B. cereus* enterotoxin after being held at 10°C until their expiration date. However, these same samples were negative for enterotoxin when stored at 4°C.

Growth of enterotoxigenic *B. cereus* strains in pasteurized milk is well documented (Christiansson et al., 1989; Griffiths, 1990; Wong et al., 1988), with this organism exhibiting an average generation time of 17 h at 6°C (Griffiths and Phillips, 1990). When naturally contaminated retail pasteurized milk was stored at 7°C, van Netten et al. (1990) found that *B. cereus* attained levels of 10^3 – 10^5 cfu/mL in 85% of samples by the “sell by” date. Furthermore, selected *B. cereus* isolates from these samples also grew and produced enterotoxin in pasteurized milk after 24, 12, and 2 days of incubation at 4, 7, and 17°C, respectively. When Griffiths (1990) inoculated sterile reconstituted skim milk to contain 10^4 *B. cereus* cfu/mL, the organism grew to 10^7 cfu/mL and produced detectable levels of toxin after only 7 days of storage. Nonetheless, enterotoxin is generally confined to pasteurized milk containing greater than 10^7 *B. cereus* cfu/mL, which accounts for the lack of milkborne cases of *B. cereus* poisoning, and such milk frequently shows obvious spoilage.

Presence of *B. cereus* in powdered milk probably poses the greatest public health concern, because both pasteurization and spray drying induce germination and outgrowth of spores in the reconstituted product. According to Rodriguez and Barrett (1986), *B. cereus* was identified in five of eight (62.5%) dried milk samples analyzed in California, with most larger European surveys yielding contamination rates of 27–57% (Becker et al., 1994). *B. cereus* was similarly present in 13–43% of nonfat dry milk-based infant formula manufactured in former West Germany (Becker et al., 1994), with Rowen et al. (1997) also respectively identifying *B. cereus* in 17 and 63% of dried and reconstituted infant formula marketed in the United Kingdom. However, levels of *B. cereus* in these products seldom exceeded 1000 cfu/g.

Growth of *B. cereus* to hazardous levels in reconstituted nonfat dry milk and infant formula is well documented. Using naturally contaminated reconstituted nonfat dry milk, Rodriguez and Barrett (1986) reported *B. cereus* populations of more than 10^6 cfu/mL following 12–22 and 24–56 h of incubation at 30 and 20°C, respectively, with samples not yet showing signs of spoilage. However, growth of the organism was generally prevented when identical samples were stored at 5°C. Similar growth of *B. cereus* in reconstituted infant formula during ambient storage has been reported (Becker et al., 1994; Rowan and Anderson, 1998). Because infants are particularly susceptible to *B. cereus* poisoning, a proposal has been introduced in Europe to limit *B. cereus* levels in infant formula to less than 1000 cfu/g (Becker et al., 1994), with even stricter standards being likely to be enforced in the future.

B. cereus contamination is not confined to the aforementioned products, with this pathogen also having been identified in cheese and evaporated whey (Pirttijarvi et al., 1998). According to Ahmed et al. (1983a), *B. cereus* was recovered from 14% of Cheddar cheese samples and 48% of ice cream samples tested in Wisconsin, with contamination levels not exceeding 200 cfu/g in Cheddar cheese and 3800 cfu/g in ice cream. Spores of *B. cereus* can survive in experimentally produced Cheddar cheese for at least 52 weeks (Mikolajcik et al., 1973). However, the pH of properly prepared Cheddar cheese (i.e., pH 5) is sufficiently low to inhibit spore germination and growth of vegetative cells (van Netten et al., 1990). Consequently, low levels of *B. cereus* in properly fermented dairy products are of minimal public health concern.

6. Prevention

Widespread occurrence of *B. cereus* in the natural environment ensures continued recovery of this organism from milk and other dairy products during all stages of production. Unlike other milkborne pathogens to be discussed, heat-resistant *B. cereus* spores readily germinate as a result of pasteurization with outgrowth and enterotoxin production occurring in products stored at temperatures near refrigeration. However, because *B. cereus* populations greater than 10^5 cfu/g (Langeveld et al., 1996) are invariably needed to induce illness, dairy-related outbreaks of *B. cereus* poisoning are readily prevented by minimizing contamination of raw milk at the farm level and storing both fluid and reconstituted milk at temperatures less than or equal to 4°C. Active starter cultures also minimize growth of this organism during manufacture of fermented dairy products.

C. Botulism

One of the rarest and most fatal milkborne diseases, botulism, results from ingesting minute amounts of a preformed neurotoxin produced by the bacterium *Clos-*

tridium botulinum. This toxin, termed botulin toxin, is 100,000 times stronger than rattlesnake venom, with the human lethal dose estimated at $0.1-1.0 \times 10^{-6}$ g (Hobbs, 1986). During the early 1800s, investigators in central Europe traced the source of this illness to liver and blood sausage from which the term *botulism* (from the Latin word *botulus*, meaning sausage), also known as “sausage poisoning,” is derived (Hauschild, 1989). The causative organism was first isolated and named *Bacillus botulinus* by van Ermengem in 1896 after a Belgian outbreak that was traced to home-cured ham. This organism was later reclassified as *C. botulinum*.

Botulism is usually associated with consumption of low-acid ($\text{pH} > 4.6$) foods such as home-canned vegetables, canned cured meats, fermented sausage, and cured fish, which are packaged in air-tight containers, with dairy products seldom being implicated (Hauschild, 1989). Only 6 of 971 (0.62%) botulism outbreaks (26 of 2430 cases, or 1.07%) reported in the United States from 1899 to 1994 (Headrick et al., 1996; Solomon et al., 1995) were linked to dairy products (all cheeses), with the last 8 United States cases being reported in 1993 (Meyer and Eddie, 1951; Townes et al., 1996). Worldwide, only 13 dairy-related outbreaks of botulism involving a total of 163 cases have been documented. Recent work on milk products has focused on different means of preventing *C. botulinum* growth and toxin production in processed cheese spread, a product that was responsible for one fatality in 1951 and a small outbreak in Argentina during 1974 (Briozzo et al., 1983).

1. General Characteristics

C. botulinum is the taxonomic designation given to a group of gram-positive, strictly anaerobic, rod-shaped, spore-forming bacteria that produce a characteristic neurotoxin (Hauschild, 1989). Most strains are motile by peritrichous flagella and produce oval spores either centrally or subterminally, which distend the cell wall (Cato et al., 1986). Although biochemically diverse, all isolates produce gas from glucose and hydrolyze gelatin, with most strains also exhibiting lipase activity. Growth-limiting temperatures are 3.5 and 50°C; however, considerable variation has been observed between strains (Conner et al., 1989; Hauschild, 1989). Although growth has been demonstrated in laboratory media at pH values as low as 4.0, growth and toxin production do not generally occur in foods having a pH less than 4.6, with some strains failing to grow at less than pH 5.0.

By definition, all *C. botulinum* strains produce at least one of seven antigenically distinct neurotoxins, designated types A, B, C, D, E, F, and G, with some strains producing two toxins (e.g., types A and B, A and F, B and F, C and D) (Conner et al., 1989; Hauschild, 1989). Biochemically, these toxins are proteins ranging in molecular weight from 150,000 to 900,000 Ds. Toxin production occurs intracellularly, with the toxin being released into the external environ-

ment during logarithmic growth and subsequent cell lysis. Unlike staphylococcal enterotoxin, all botulin toxins are heat labile and rapidly destroyed by boiling. Based on proteolytic activity and type of toxin produced, all *C. botulinum* isolates can be divided into the following four groups: (a) proteolytic types A, B, and F, (b) nonproteolytic types B, E, and F, (c) proteolytic and nonproteolytic types C and D, and (d) proteolytic type G. Thus far, only those strains producing toxin types A and B have been associated with dairy-related outbreaks of botulism, with growth and toxin production at refrigeration temperatures being confined to nonproteolytic type B strains.

2. Analysis of Dairy Products for *C. botulinum* and Botulin Toxin

Upon receipt of the sample, one portion is analyzed for viable *C. botulinum* organisms and a different portion is examined for botulin toxin. Recovery of the organism from dairy products begins with primary enrichment in cooked meat medium (CM) at 26–28°C and trypticase-peptone-glucose-yeast extract broth (TPGYE) at 35°C (Kauter et al., 1992; Solomon et al., 1995). After 7 days and, if necessary, up to 17 days of incubation, both broth cultures are microscopically examined for typical tennis racket-shaped, spore-forming bacteria resembling *C. botulinum*. One portion of the positive broth culture is immediately centrifuged and analyzed for botulin toxin. The remaining portion is ethanol treated or heat treated to eliminate the non-spore-forming background flora and then is surface plated on liver-veal-egg yolk agar (LVEY) or anaerobic egg yolk agar (AEY) to obtain isolated colonies. After 48 h of anaerobic incubation at 35°C, 10 *C. botulinum*-like colonies are recultured in CM or TPGYE and then restreaked to LVEY or AEY for purification.

Toxin analysis begins by macerating and then extracting the sample with an equal volume of gel-phosphate buffer at pH 6.2 (Kauter et al., 1992; Solomon et al., 1995). After centrifugation of the extracted food sample or aforementioned broth culture, one portion of the supernatant liquid is treated with trypsin to activate botulin toxins produced by nonproteolytic strains. After diluting a portion of the trypsin-treated and untreated supernatant liquids 1:5, 1:10, and 1:100 in gel-phosphate buffer, 0.5 mL of each preparation is injected intraperitoneally into pairs of white mice; a boiled untrypsinized and undiluted preparation serves as the control. During the next 48 h, the mice are observed for symptoms of botulism, which include ruffled fur, labored breathing, limb weakness, total paralysis, and death resulting from respiratory failure. However, death alone does not provide conclusive evidence that the preparation contained botulin toxin. Establishing the amount of toxin in the sample is dependent on some of the mice surviving. The type of toxin in the sample can be determined by first injecting the mice with monovalent antitoxins to types A, B, E, and F. Although not yet approved

for official use, several enzyme-based immunosorbent assays for toxin detection are available; thus circumventing the problems associated with animal tests.

3. Clinical Manifestations

Dairy-related botulism outbreaks have been confined to products (primarily cheeses) containing toxin types A and B, which, together with type E found in fish, comprise the most lethal of the seven known toxin types. The first symptoms of botulism normally develop within 12–36 h of ingesting the preformed toxin and include diarrhea, nausea, and vomiting followed by persistent constipation (Donta, 1986; Hauschild, 1989; Smith, 1990). Soon after being absorbed by the gastrointestinal tract, the toxin enters the bloodstream and begins to shut down the peripheral nervous system by attaching to the tips of motor nerve endings, which in turn prevents release of acetylcholine at neuromuscular junctions. Neurological symptoms associated with this classic phase of the illness include blurred and double vision; difficulty in speaking and swallowing; a dry mouth, throat, and tongue; fatigue; lack of muscle coordination; and, in extreme cases, total paralysis, with death by respiratory failure within as little as 24 h from initial onset of gastroenteritislike symptoms. Because botulism can be confused with Guillain-Barré syndrome, carbon monoxide poisoning, myasthenia gravis, and other types of food poisoning, a quick and accurate diagnosis based on the patient's clinical symptoms and case history is essential for proper treatment and full recovery. Eventual confirmation of suspected cases is dependent on detecting botulinum toxin or viable *C. botulinum* cells in appropriate clinical specimens.

Before antitoxins and modern mechanical respirators were available, at least half of all victims died, making botulism the gravest of the milkborne diseases. However, the fatality rate has been reduced to 5–15% in the United States and most other industrialized countries (Donta, 1986; Hauschild, 1989; Smith, 1990). Initial treatment of botulism is focused on toxin removal or inactivation by neutralizing circulating toxin with antitoxin before the toxin irreversibly binds to the nerve endings. Induced vomiting, gastric lavage, and enemas are also used to help rid the body of toxin. Subsequent treatments are directed toward counteracting paralysis of respiratory muscles with mechanical respirators, which are required by 80% of victims in the United States. Chemotherapy is limited to administration of guanidine, which is sometimes helpful in restoring nerve function. However, prolonged use normally leads to serious side effects.

4. Outbreaks

Historically, dairy products have been responsible for less than 1% of all foodborne botulism cases, with only 13 outbreaks involving a total of 163 cases reported worldwide since 1899. Before 1952, only six small dairy-related outbreaks affecting 19 people (9 of whom died) were documented in the United States,

with four outbreaks reported in California (1912, 1914, 1935, and 1951) and two outbreaks occurring in New York (1914, 1939) (Meyer and Eddie, 1951). All of these outbreaks were cheeseborne and traced to cheeses such as cottage, Limburger, and Neufchâtel prepared at home. In the 1914 New York outbreak, Nevin (1921) reported that three people died after eating homemade cottage cheese stored in sealed tins, with *C. botulinum* growth and toxin production demonstrable in inoculated cottage cheese after 72 h of incubation at 37°C. In another anecdotal account by Meyer and Eddie (1951), three botulism cases and one death were traced to an ethnic-type curd cheese that was ripened below ground in a buried canvas-covered crock; *C. botulinum* undoubtedly entered the product from the soil. In 1951, a 53-year-old man died within 3 days of eating several ounces of a pasteurized process soft-ripened Limburger cheese spread that reportedly tasted peculiar (Meyer and Eddie, 1951). Subsequent tests with mice demonstrated type B botulinum toxin in the remaining product, with 4 of 51 additional jars of cheese spread also reportedly being toxic. Most recently, commercially canned cheese sauce was traced to eight cases of type A botulism, including one fatality in southern Georgia during October of 1993 (Townes et al. 1996). Follow-up inoculation studies confirmed that the cheese sauce could support *C. botulinum* growth and toxin production after 8 days of ambient storage.

The six remaining outbreaks occurred outside of the United States since the 1970s. During July and August of 1973, ripened Brie cheese was epidemiologically linked to two simultaneous outbreaks of type B botulism: one in Marseilles, France (32 cases) and the other in Switzerland (42 cases) (Gilles et al., 1974; Kauf et al., 1974; Sebald et al., 1974). Surprisingly, no fatalities were reported among the 75 cases. Although the implicated cheese was not available for testing, all cheeses were ripened on the same batch of unclean straw in both Marseilles and Switzerland, thereby providing a plausible means of contamination. Toxin production in the rind of similarly ripened cheeses was later demonstrated experimentally (Billon et al., 1980).

Early in 1974, Argentinian authorities reported that a commercially produced cheese spread containing onions was responsible for six cases of type A botulism, including three deaths, in Buenos Aires (Briozzo et al., 1983). Investigators eventually blamed the outbreak on several cheese formulation deficiencies, including an overly high moisture content and pH, which permitted *C. botulinum* growth and toxin production.

The fourth dairy-related outbreak of botulism occurred in 1989 and involved 27 cases (including one death); it was unusual in several respects (Critchley et al., 1989; O'Mahony et al., 1989). First, the outbreak originated in the United Kingdom, a country that has seen only nine cases of foodborne botulism since 1922 with no cases being traced to milk or dairy products. Second, hazelnut yogurt, a very unusual product (i.e., pH < 4.6, refrigerated) never before associated with botulism, was identified as the cause of this epidemic. Third, wide sales distribution of the product led to patients seeking treatment at different

hospitals. Investigators identified type B botulinal toxin and later type B *C. botulinum* in opened and unopened cartons of hazelnut yogurt as well as in one fecal specimen and in a blown can of hazelnut conserve. All implicated lots of hazelnut yogurt and conserve were recalled and warnings were issued to the general public. Thermal processing of the hazelnut conserve was later shown to be inadequate for destruction of *C. botulinum* spores, with *C. botulinum* growth and toxin production occurring in these cans of product during long-term storage. The last two reported outbreaks were traced to two different cheeses, an Iranian cheese responsible for 27 cases of type A botulism, including one fatality, in northern Iran (Pourshafie et al., 1998) and a commercially produced Mascarpone cheese that led to a single fatal case of type A botulism in Italy (Spolaor 1996). In a follow-up survey, 327 of 331 samples from two different production lots of Mascarpone cheese contained *C. botulinum* type A, 7 samples of which also yielded type A toxin. Other naturally contaminated cheeses containing <10 spores/g became toxic after 3 days of storage at 28°C. (Franciosa et al., 1999).

5. Occurrence and Survival in Dairy Products

Spores of *C. botulinum* are widespread in the natural environment, with soil serving as the primary reservoir (Hauschild, 1989; Smith, 1990). Consequently, vegetation, animal feed, and fresh produce are most frequently contaminated. Few domestic farm animals, including dairy cattle, are fecal carriers of *C. botulinum*; this organism also is not known to cause mastitis in ruminant animals.

Spore-forming bacteria, including *C. botulinum*, are frequent contaminants of raw and pasteurized milk. Although these spores readily survive pasteurization as evidenced by several spore-related defects, toxin production in raw and drinkable pasteurized milk does not occur because of the product's short refrigerated shelf life and the inability of this organism readily to compete with the native psychrotrophic background flora (Glass et al., 1999). However, Kaufmann and Brillaud (1964) found that *C. botulinum* types A and B did grow and produce toxin in cans of sterilized skim milk after 46–56 days of storage at 13°C. Read et al. (1970) also reported growth and toxin production by *C. botulinum* type E in inoculated cans of commercially sterilized whole milk after 3–28 days of storage at 20°C, with one sample being toxic after 70 days of incubation at 7.2°C. However, *C. botulinum* type E is typically confined to fish products and has never been associated with dairy products.

The aforementioned fatalities in 1951 and 1974 involving processed cheese spread prompted extensive investigations into the safety of these anaerobically packaged, long-shelf life products. In a series of three studies by Wagenaar and Dack (1958a, 1958b, 1958c), *C. botulinum* growth and toxin production was related to the pH, moisture, a_w , and salt content of process cheese spreads prepared from three different varieties of surface-ripened cheeses, with the toxin in these cheeses being stable for 2–4 years (Grecz et al., 1965). Several subsequent inves-

tigators (Briozzo et al., 1983; Kauter et al., 1979) reported toxin production in inoculated samples of commercially prepared pasteurized process cheese spread having a pH greater than or equal to 5.70 and an a_w greater than or equal to 0.936, suggesting that these products should be classified as low-acid foods (pH > 4.6, a_w > 0.85). However, when Tanaka et al. (1979) prepared pasteurized processed cheese spread according to the United States federal standards of identity (52% moisture, 2% sodium chloride, and 2.5% disodium phosphate), inoculated samples remained nontoxic during 11 months of storage at 30°C. Given these parameters, toxin development would not be expected in such cheese spreads having an a_w less than 0.95 (Hauschild, 1989). The fact that the cheese spread implicated in the Argentinian outbreak had an a_w of 0.97 (Brizzo et al., 1983) further supports this conclusion. However, production of nontoxic process cheese spreads containing less salt or up to 60% moisture is also possible by decreasing the pH and increasing the level of various phosphates, which in turn lowers the a_w (Eckner et al., 1994; Karahadian et al., 1985; Tanaka et al., 1986). Furthermore, direct addition of nisin, a bacteriocin produced by *Lactococcus lactis* subsp. *lactis* that prevents germination of *C. botulinum* spores, to process cheese spreads at levels up to 250 ppm affords additional protection against *C. botulinum* growth and allows production of reduced sodium and sodium chloride-free spreads (Somers and Taylor, 1987). Several microbial models also have been published which assess the impact of cheese composition on outgrowth of *C. botulinum* and toxin production (Ter Steeg and Cuppers, 1995; Ter Steeg et al., 1995).

6. Prevention

The few reported botulism cases traced to dairy products have primarily involved anaerobically packaged cheeses, with process cheese spreads being of greatest concern. Although contamination of such products with spores of *C. botulinum* cannot be prevented, the threat of toxin production can be eliminated by carefully controlling the pH, moisture content, a_w , phosphate level, and nisin content of the finished product. Furthermore, most dairy-related botulism cases have involved proteolytic strains of *C. botulinum* types A and B, with the implicated products showing obvious signs of spoilage. Such products in swollen containers should be immediately discarded and never tasted. Continued Food and Drug Administration (FDA) enforcement of established governmental standards for preventing *C. botulinum* growth and toxin production in high-risk foods also plays an important role in preventing future dairy-related outbreaks of botulism, seven non-complying cheese products were recalled since 1990 without incident.

D. Brucellosis

Human brucellosis, a classic zoonosis presumably prevalent in the Mediterranean countries since antiquity (Anonymous, 1995a; Tarala, 1969), is primarily ac-

quired through direct or indirect contact with infected animals harboring three of six bacterial species belonging to the genus *Brucella*. Two of these species, *Brucella melitensis* and *B. abortus*, are pathogenic to goats and sheep and to cattle, respectively, and are consequently of major concern to the dairy industry. The remaining species, *B. suis*, is primarily found in pigs and, as such, has been only rarely associated with milkborne cases of brucellosis (Horning, 1935). In 1887, while working as a British naval surgeon on the island of Malta, Bruce was first to isolate an organism from four fatal cases of a disease he termed "Malta fever," now commonly known as undulant fever. By 1904, Maltese goat's milk was confirmed as the source of infection (Hammer, 1938; Rammell, 1967; Tarala, 1969), with the causative organism, *B. melitensis*, still recognized as the *Brucella* sp. most pathogenic for goats, sheep, and humans (Hendricks and Meyer, 1975). Although probably present since Biblical times, the second of these two organisms was not identified until 1895 when the Danish veterinarian Bang identified *B. abortus* as the causative agent of contagious abortion (Bang's disease), an economically devastating affliction in dairy cattle. However, the close relationship between *B. abortus* and *B. melitensis* was not recognized until 1918, when Evans linked cow's milk to cases of undulant fever in the United States (Hammer, 1938; Stiles, 1989).

1. General Characteristics

All six *Brucella* spp. are small, nonmotile, coccobacilli or short rod-shaped, gram-negative bacteria that are found singly, in pairs, and in short chains (Moyer and Holcomb, 1995). Both *B. melitensis* and *B. abortus* are intracellular parasites that localize and grow within the rough endoplasmic reticulum of nonphagocytic host cells. Although able to grow aerobically at 10–40°C, with optimal growth occurring at 37°C, some strains grow better in an atmosphere containing 5–10% CO₂. Brucellae are nutritionally fastidious and require biotin, pantothenic acid, thiamine, nicotinamide, trace amounts of magnesium, and occasionally bovine serum for growth. Consequently, propagation on ordinary solid media can be difficult. Biochemically, *B. melitensis* and *B. abortus* are catalase positive, oxidase positive, and metabolically oxidative (Moyer and Holcomb, 1995). Despite some cultural, biochemical, serological, and host differences among the brucellae, DNA-DNA hybridization and ribotype analyses (Anonymous, 1988a) indicate that all six currently recognized *Brucella* spp. are closely related and comprise only one genospecies, *B. melitensis*.

2. Clinical Manifestations

Human brucellosis, which ranges from a mild flu-like illness to a severe disease (undulant fever), defies easy diagnosis because of differences in reported symptoms (Dalrymple-Champneys, 1960; Young, 1983). Even an increasing and de-

creasing temperature, the symptom for which undulant fever is named, may not always occur. The severity of brucellosis is partially dependent on the species involved, with *B. melitensis* being most pathogenic for humans, followed by *B. suis* and *B. abortus*. Onset of symptoms can be either abrupt or gradual following a normal incubation period of 3–21 days. However, incubation periods of 7–10 months also have been reported (Moyer and Holcomb, 1995). Brucellosis patients typically have multiple complaints but show few physical abnormalities. Symptoms associated with the sudden-onset form of brucellosis have included pyrexia, profuse sweating, chills, weakness, malaise, various aches, chest and joint pain, weight loss, and anorexia, with physical findings limited to disturbances of the spleen and lymphatic system (Dalrymple-Champneys, 1960; Young, 1983). Osteomyelitis is the most common complication from *B. melitensis* infection followed by skeletal, genitourinary, cardiovascular, and neurological complaints (Young, 1983). Victims of the gradual-onset, chronic form of brucellosis exhibit long histories of recurrent fever and depression, malaise, headaches, sweating, vague pains, impotence, and insomnia, with eventual incapacitation also being reported (Stiles, 1989).

Slow growth of brucellae on laboratory media frequently delays primary isolation of the organism, with fewer than 20% of all cases initially being confirmed by recovering *Brucella* spp. from blood, bone marrow, or infected tissues (Stiles, 1989). Consequently, preliminary diagnosis is normally based on serological findings (Young, 1991a). Treating brucellosis with antibiotics is also difficult, because the organism is localized intracellularly. Therefore, combined oral administration of several antibiotics with high intracellular activity, such as tetracycline, streptomycin, rifampin, or trimethoprim-sulfamethoxazole (Street, 1975; Young, 1983; Young and Suvannoparrat, 1975), is the prescribed cure for typical *Brucella* infections.

3. Outbreaks

Worldwide, brucellosis remains one of the most widespread and costly diseases afflicting humans and animals, with this disease presently endemic in northern Mexico (Salman and Meyer, 1984; Teclaw et al., 1985; Thapar and Young, 1986; Young, 1991b) as well as many South American (Wallach et al., 1994), Latin American (Wallach et al., 1994), Mediterranean (Anonymous, 1995a), Middle Eastern (Anonymous, 1995a; Nour, 1982; Sabbaghian and Nadim, 1974), and African countries (Anonymous, 1995a; Cherif et al., 1986; Fakuuzi et al., 1993). Consumption of unpasteurized dairy products, including milk (Foley, 1970), cream (Barrow et al., 1968), and cheese (Anonymous, 1995a; Galbraith, 1969; Hammer, 1938; Rammell, 1967; Young and Suvannoparrat, 1975) has traditionally accounted for approximately 10% of all reported brucellosis cases (Anonymous, 1972; Stiles, 1989), with the remainder occurring primarily among veteri-

narians, farmers, and meat processors who contract the disease through direct contact with infected livestock (Wallach et al., 1997).

Mandatory pasteurization of milk and highly effective brucellosis eradication programs for livestock have drastically reduced the number of reported cases in the United States from more than 600 in 1945 to 119 in 1994 and 79 in 1998, giving an annual incidence rate of one case for every 2 million people. Although brucellosis occurs throughout the United States, this disease has a long history in the American southwest (Anonymous, 1994c) and among Hispanic people who become infected after consuming unpasteurized milk (Schlusser et al., 1997) and certain types of soft unripened cheese produced in Mexico (Eckman, 1975). El Paso, TX, was the site of three separate brucellosis outbreaks in 1968 (Seyffert and Bernard, 1969), 1973 (Street et al., 1975; Young and Suvannoparrat, 1975), and 1983 (Tharper and Young, 1986), all of which involved consumption of Mexican-produced raw goat's milk cheese. A similar outbreak involving 31 primarily Hispanic patients who consumed fresh goat's milk cheese (queso blanco) illegally imported from Mexico occurred in Houston, TX, during 1983 (Thapar and Young, 1986)—a year in which 84 brucellosis cases were reported to the Texas Department of Health (Thapar and Young, 1986). Three of four Mexican border states, namely, Texas, Arizona, and California, respectively, accounted for 29, 17, and 36 of the 119 (69%) brucellosis cases reported nationally in 1994 (Anonymous, 1994c), with many of these ongoing sporadic cases (Schlusser et al., 1997) presumably being linked to consumption of illegally imported raw milk Mexican cheese.

In England and Wales, dairy-related brucellosis outbreaks have been virtually eliminated after instituting similar programs for brucellosis eradication in livestock and mandatory pasteurization of milk (Barrett, 1989). Only 17 cases of milkborne brucellosis were reported in England and Wales from 1950 to 1989 (Galbraith et al., 1982; Sockett, 1991), of which 10 cases were linked to raw cow's milk containing *B. abortus* and 7 cases to *B. melitensis* in raw pecorino sheep cheese imported from Italy (Galbraith et al., 1969). However, at least nine additional people also reportedly contracted brucellosis after returning from Spain and the Middle East (Barrett, 1986; Porter and Smith, 1971), with raw sheep's milk, raw goat's milk, and goat's milk cheese being the probable vehicles of infection. Even though the number of brucellosis cases in England and Wales presently appears to be increasing, with 49 cases reported from 1992 to 1995, at least 28 of these cases were acquired abroad during visits to Malta, Spain, Portugal, France, Italy, Greece, Bosnia, Turkey, Egypt, Israel, Jordan, Qatar, Oman, Pakistan, Somalia, and Tanzania (Anonymous, 1995a), with many of these cases presumably being milkborne or cheeseborne. Two of these cases were linked to a massive outbreak in Malta during the first half of 1995 involving 135 cases of *B. melitensis* brucellosis in which soft cheese prepared from unpasteurized sheep's and goat's milk was identified as the vehicle of infection (Anonymous,

1995a). Sporadic dairy-related cases of brucellosis continue to occur in western Europe (Vogt and Hasler, 1999), with one unusually large 1994–1995 outbreak of 81 cases in Spain being traced to fresh unpasteurized cottage-type cheese that was prepared from infected ewe's milk (Castell et al., 1996). Consequently, travelers to areas where brucellosis is endemic should consider avoiding raw milk and cheeses prepared from raw milk.

4. Occurrence and Survival in Milk and Dairy Products

Information concerning the incidence of brucellae in the raw milk supply is generally lacking, with only one Mexican survey reporting a *Brucella* contamination rate of 2.3 and 4.2% for raw cow's and goat's milk, respectively (Acedo et al., 1997). However, contamination rates are presumably even lower in countries with well-developed brucellosis eradication programs. Within infected herds, brucellae can persist in the udders of cows for many years following an abortion and can be intermittently shed at levels up to 15,000 organisms/mL for as long as 5 months (Rammell, 1967). When naturally contaminated raw milk is held at 25–37°C, *Brucella* populations typically decrease to nondetectable levels within 2–3 days (Kuzdas and Morse, 1954; Mitscherlich and Marth, 1984). However, brucellae survive at least 42 and 800 days when such milk is stored at 4°C (Mitscherlich and Marth, 1984) and –40°C (Kuzdas and Morse, 1954), respectively.

Cream and butter are unusual sources for *Brucella* spp., with only 5 of 916 cream samples being positive in one outbreak-related survey (Barrow et al., 1968). However, both products can support extended survival of brucellae, with *B. melitensis* and *B. abortus* persisting 4 and 6 weeks, respectively, in inoculated cream stored at 4°C (Rammell, 1967). More recently, *Brucella* spp. reportedly survived 94–102 days and greater than 140 days in inoculated cream that was stored at 20–25°C and 2–4°C, respectively (Nour, 1982); this further confirms the increased persistence of *Brucella* at refrigeration temperatures. According to several reports referenced by Rammell (1967), brucellae can survive even longer in refrigerated butter (King, 1957); persisting 6–13 months in salted and unsalted butter, respectively (Fulton, 1941).

As is true for cream and butter, brucellae have become virtually nonexistent in domestic and imported cheeses sold legally in the United States. This is not true for dairy products sold in Mexico, Argentina, and many of the Mediterranean and Middle Eastern countries, as evidenced by the many aforementioned dairy-related brucellosis cases. One recent Mexican survey identified *Brucella* spp. in 25 of 335 soft white cheeses (Acedo et al., 1997), whereas another survey from Turkey (Sancak et al., 1993) indicated that 7 of 40 raw sheep's milk cheeses contained *B. melitensis* or *B. abortus*.

Long-term survival of *Brucella* in many cheese varieties has been recognized since the 1940s (Rammell, 1967). *B. abortus* survived 6 days in Emmental and Gruyère, 15 days in Tilsit, and 57 days in Camembert cheese prepared from milk inoculated to contain 10,000 brucellae/mL (Kästli and Hausch, 1957). This organism also persisted 90 days in pecorino cheese (Rammell, 1967) and up to 60 days in Roquefort cheese (King, 1957). When Cheddar cheese was prepared from milk containing 1000 *B. abortus* cfu/mL and ripened at 4°C, the organism remained viable for 6 months (Gilman et al., 1946). Most recently, traditional manufacturing practices failed to eliminate *B. abortus* from Mexican white soft cheese during 21 days of storage at 5°C (Diaz Cinco et al., 1994). Even though these studies raise serious concerns regarding the safety of raw milk cheeses, standard vat and high-temperature, short-time pasteurization (Bryan, 1979) both inactivate *Brucella* populations in milk with a very large margin of safety.

5. Prevention

Preventing dairy-related cases of brucellosis is based on eliminating this disease in animals through immunization programs, slaughtering of infected animals, mandatory pasteurization of milk, and aging of cheeses that can legally be prepared from raw milk for at least 60 days. Even though this disease has been largely controlled in the United States, the recent upsurge of cases along the United States–Mexican border, combined with increased reports of British citizens acquiring this disease abroad, indicates that travelers to areas where brucellosis is endemic should avoid consuming raw milk as well as fresh cheeses (particularly goat's milk cheese) prepared from unpasteurized milk.

E. Campylobacteriosis

Although recognized since 1909 as an important cause of abortion in cattle and sheep (Stern and Kazmi, 1989), *Campylobacter jejuni*—the causative agent of campylobacteriosis—remained an obscure human enteric bacterial pathogen until the late 1970s. Improved isolation strategies (Dekeyser et al., 1972) leading to recovery of *Campylobacter* from 7.1% of randomly selected patients with diarrhea (Skirrow, 1977) suggested that this organism was of more than passing importance in human gastroenteritis. Although generally considered a sporadic illness with a propensity for children, 45 foodborne campylobacteriosis outbreaks (1308 cases) were reported in the United States between 1978 and 1986, over half of which involved ingestion of raw milk (Anonymous, 1998b). Similar reports linking raw or inadequately pasteurized milk to 13 outbreaks in Great Britain from 1978 to 1980 (Robinson and Jones, 1981) helped to further substantiate *C. jejuni* as an important milkborne pathogen. In 1998, the overall incidence rate

for *Campylobacter* infections (19.7/100,000 population) exceeded *Salmonella* infections (13.9/100,000 population) (FoodNet, 1998), with an estimated 2 million annual cases of this non-notifiable disease in the United States (DeMol, 1994). Given similar reports from Canada (Lior, 1994a), Europe (Stringer, 1994), and developing countries (Taylor, 1992), campylobacteriosis has come to rival or surpass salmonellosis as the leading form of human gastroenteritis worldwide.

1. General Characteristics

The genus *Campylobacter* (Greek for “curved rod”) includes 18 species and subspecies within the family Campylobacteraceae, with six of these organisms identified as threats to human health (Hunt and Abeyta, 1995; Nachamkin, 1995). Two seldom differentiated species, *C. jejuni* subsp. *jejuni* (hereafter *C. jejuni*) and *Campylobacter coli*, are well-recognized causes of human foodborne gastroenteritis, with the former accounting for approximately 90% of such cases (Hunt and Abeyta, 1995). Of the four remaining species, *C. upsaliensis*, *C. lari*, and *C. hypointestinalis* have been only recently linked to sporadic gastrointestinal disorders, and *C. fetus* subsp. *fetus* is primarily associated with bacteremia and systemic infections in patients with underlying illnesses.

Morphologically, all campylobacters are small, gram-negative, curved, S-shaped or spiral rods, which are motile by means of a single polar flagellum. All species of the genus are oxidase-positive, urease-negative, and both methyl red- and Voges-Proskauer-negative. Of the six aforementioned species of concern to humans, all produce catalase (Nachamkin, 1995) and all except *C. fetus* grow optimally at 42°C. However, all campylobacters are obligate microaerophiles and, as such, require an atmosphere of 5% O₂, 10% CO₂, and 85% N₂ for optimal growth.

2. Isolation and Identification

High numbers of *Campylobacter* are normally present in human diarrheal specimens, and microaerobic incubation of such samples streaked on commonly used selective media such as Skirrow’s medium and charcoal cefoperazone deoxycholate agar allows for relatively simple recovery of the organism (Nachamkin, 1995). However, isolation of *Campylobacter* from raw milk is far more challenging because the organism is likely to be greatly outnumbered by the normal bacterial flora of the milk. Consequently, selective enrichment under microaerobic conditions became a crucial initial step in all early procedures for recovering *Campylobacter* from raw milk (Doyle and Roman, 1982a; Hunt et al., 1985; Lovett et al., 1983). All three methods currently recommended for detecting *Campylobacter* in raw milk (Flowers et al., 1992a; Hunt et al., 1998; Stern et al., 1992) are complicated and require initial centrifugation of the raw milk sample, selective enrichment of the pellet at 42°C under microaerobic conditions (5% O₂,

10% CO₂, 85% N₂), and subsequent plating on two selective media followed by similar incubation. The FDA procedure for dairy products (Hunt et al., 1998) also includes a 4-h microaerobic preenrichment step at 37°C, followed by 24 h of incubation at 42°C with continuous shaking. Suspect isolates (round to irregular spreading colonies with smooth edges) obtained using these procedures are then examined microscopically for morphological characteristics and motility and subsequently speciated using a standard series of biochemical tests in addition to resistance to nalidixic acid and cephalothin. Alternatively, several DNA probe-based diagnostic kits and antibody-based assays are now commercially available for identifying positive samples (Feng, 1998).

3. Clinical Manifestations

Campylobacter enteritis affects all age groups but is particularly common among children. Most dairy-related cases of campylobacteriosis are presumably acquired indirectly through consumption of raw milk with person-to-person infections infrequent and normally limited to young children with acute diarrhea. Typical attack rates of at least 50% in milkborne outbreaks suggest that the oral infective dose is relatively low. Robinson (1981) and Block et al. (1978) confirmed that ingesting as few as 500 to 800 total cells of *C. jejuni* can induce illness after the normal 2- to 5-day incubation period with the infective rate, severity of illness, and incubation period remaining unaltered as the oral infective dose increases to as many as 2×10^9 organisms. However, routine consumption of raw milk lowers the attack rate and results in partial immunity to symptomatic infections (Blaser et al., 1987).

Flu-like symptoms develop in approximately one-third of patients sufficiently ill to seek medical attention; symptoms include a mild fever that occurs 2–3 days before appearance of diarrhea, which likely represents the initial invasive and sometimes septicemic stage of infection (Nachamkin, 1995). A few such individuals may also experience severe prediarrheal appendicitis-like abdominal pain, which can lead to unnecessary surgery. Onset of diarrhea is sudden and can be severe, with development of profuse watery stools through action of a heat-labile cholera-like toxin produced by most strains of *C. jejuni* and *C. coli*. Bloody diarrhea sometimes develops, which mimics ulcerative colitis caused by shigellae. Various extraintestinal complications including bacteremia, reactive arthritis, bursitis, urinary tract infections, meningitis, endocarditis, peritonitis, and pancreatitis can occur among elderly and immunocompromised adults as can occasional fatalities. Abortion and neonatal septicemia have been cited as complications affecting pregnant women (Blaser, 1990). Two additional complications, namely, Guillain-Barré syndrome (Mishu and Blaser, 1993) and acute motor axonal neuropathy (McKhann et al., 1993), also were reported in Japan and China, respectively, with a single serotype of *C. jejuni* appearing to be responsible.

Presumptive diagnosis of *Campylobacter* enteritis is based on direct microscopic observation of *Campylobacter*-like organisms in stool specimens with campylobacteriosis being confirmed by isolating the organism on selective plating media. Although most patients spontaneously recover within 3–7 days, fluid replacement and oral administration of erythromycin or fluoroquinolones for 7–10 days may be needed for more severely ill patients (DeMol, 1994). Patients typically stop shedding the organism after 1–3 months. However, a small percentage of individuals remain chronic fecal carriers of *C. jejuni* and *C. coli*, thereby retaining the ability to infect others.

4. Outbreaks

Evidence for *C. jejuni* as a foodborne pathogen dates back to 1938 when milk (possibly raw) was epidemiologically linked to 357 cases of gastroenteritis among inmates of two Illinois prisons (Levey, 1947). Supporting evidence included isolation of organisms resembling *Vibrio jejuni* (*C. jejuni*) from blood and stool samples, appearance of symptoms compatible with present-day campylobacteriosis, and the fact that the outbreak ceased after incriminated milk was boiled. Nevertheless, poor isolation techniques during these early days delayed identifying *C. jejuni* as a prominent foodborne pathogen for more than 40 years.

The foodborne route for *Campylobacter* infection was not suggested again until 1976 when Taylor et al. (1979) identified four Los Angeles residents who presumably acquired campylobacteriosis after consuming certified raw milk. Beginning in 1978, raw milk–related outbreaks were recorded in the United States, with many more accounts being documented up to 1985 (Table 4). Raw milk consumption was implicated in 14 of 23 outbreaks (621, or 83% of 748 cases) reported from 1980 to 1982, with four of these outbreaks involving children (Finch and Blake, 1985). Fourteen of 20 raw milk–related outbreaks documented from 1981 to 1990 (Wood et al., 1992) were traced to children in kindergarten through third grade who became ill after returning from spring and fall field trips to dairy farms. Although sporadic outbreaks still occur, the incidence of milk-borne campylobacteriosis in the United States has decreased as a result of the 1987 ban on interstate sale of raw milk and decreasing sales of raw milk intrastate (Headrick et al., 1998).

Campylobacteriosis simultaneously emerged with similar force in Great Britain, with 27 outbreaks from 1978 to 1984 and 5 outbreaks from 1992 to 1996 (Djuretic et al. 1997) linked to consumption of raw or inadequately pasteurized milk (Hutchinson et al., 1985b; Robinson and Jones, 1981). Two additional outbreaks also were recorded in Switzerland (Stadler et al., 1983) and New Zealand (Brieseman, 1984) during the early 1980s, the former of which involved more than 500 joggers running a race.

Table 4 Campylobacteriosis Outbreaks Resulting from Ingestion of Raw Milk in the United States, Canada, and Britain

Location	Year	Number of cases	Reference
United States			
California	1976	4	Taylor et al. (1979)
Colorado	1978	3	Anonymous (1978)
Oregon	1980–1981	77	Terhune et al. (1981)
Minnesota	1981	25	Korlath et al. (1985)
Arizona	1981	200	Taylor et al. (1982a)
Kansas	1981	264	Kornblatt et al. (1985)
Georgia	1981	50	Potter et al. (1983)
Wisconsin	1982	15	Klein et al. (1986)
Oregon	1982	22	Blaser et al. (1987)
Vermont	1982	15	Vogt et al. (1984)
Pennsylvania	1983	26	Anonymous (1983)
Pennsylvania	1983	57	Anonymous (1983)
Vermont	1983	5	Hudson et al. (1984)
California	1984	12	Anonymous (1984a)
California	1985	23	Anonymous (1986)
Vermont	1986	28	Birkhead et al. (1988)
Canada			
Ontario	1980	14	McNaughton et al. (1982)
Great Britain			
England	1978	63	Robinson et al. (1979)
England	1978	22	Robinson et al. (1979)
England	1979	2500	Jones et al. (1981)
Scotland	1979	148	Porter and Reid (1980)
England	1981	46	Wright and Tillett (1983)
England	1981	22	Wright and Tillett (1983)
England	1985	75	Hutchinson et al. (1985a, 1985b)
England	1992	72	Morgan et al. (1994b)
England	1994	23	Evans et al. (1996)

Despite the many aforementioned outbreaks, confirmation of raw milk as the source of infection has remained difficult. Only three reports have appeared in which the epidemic strain was recovered from a portion of the lot of milk that was consumed (Bradbury et al., 1984; Patton et al., 1991; Salama et al., 1990); such strains were more commonly identified in fecal samples from incriminated dairy herds (Hutchinson et al., 1985b; Kornblatt et al., 1985; Potter et al., 1983; Stadler et al., 1983; Vogt et al., 1984), thus suggesting that milk was contaminated during or after milking. However, at least four campylobacteriosis outbreaks in

England were traced to glass-bottled pasteurized milk that was pecked by birds (Hudson et al., 1990; Riordan et al., 1993; Southern et al., 1990; Stewart et al. 1997), with magpies and jackdaws identified as probable carriers of *C. jejuni*.

Milkborne campylobacteriosis outbreaks have been almost invariably associated with consumption of raw or inadequately pasteurized cow's milk. However, a few cases of *C. jejuni* and *C. coli* enteritis have been traced to ingestion of raw goat's milk in the United States (Harris et al., 1987), Great Britain (Hutchinson et al., 1985a), and Australia (Gilbert et al., 1981), with the epidemic strain identified in fecal samples from incriminated goats. Other than one additional outbreak in Great Britain in which 37 cases were linked to consumption of milk shakes, no other fluid or fermented dairy products, including yogurt and cheese, have been associated with campylobacteriosis.

5. Occurrence and Survival in Dairy Products

Experimentally induced mastitis in dairy cows has led to excretion of up to 10^5 *C. jejuni* cfu/mL in milk over 7 days (Lander and Gill, 1980). However, evidence supporting such shedding by naturally infected cows is relatively limited (De Boer et al., 1984; Hutchinson et al., 1985b; Logan et al., 1982). The bovine intestinal tract remains the primary reservoir for *C. jejuni* with 19% to 64% of fecal samples being positive (DeBoer, 1984). Consequently, heavy shedding of *Campylobacter* in feces followed by fecal contamination of the milk during or after milking has come to be regarded as the primary route of contamination.

The incidence of *Campylobacter* spp. in the raw milk supply is reportedly quite low, with *C. jejuni* being recovered from only 0.4 to 1.5% (Doyle and Roman, 1982b; Lovett et al., 1983; McManus and Lanier, 1987) and 0.5% (Steele et al., 1997) of raw milk bulk tank samples examined in the United States and Canada, respectively. However, Rohrbach et al. (1992) detected *C. jejuni* in 12.3% of farm milk bulk tanks supplying eastern Tennessee, thus suggesting a markedly higher incidence of *Campylobacter* contamination. In a similar European survey, *C. jejuni* was recovered from 5.9% of raw milk bulk tank samples examined in England (Humphrey and Hart, 1988) with a strong correlation observed between *C. jejuni* and *E. coli* contamination.

The extent to which *Campylobacter* persists in milk is related to strain of *C. jejuni*, type of milk (i.e., raw, pasteurized, sterilized) and storage temperature. When raw milk was inoculated to contain 10^7 *C. jejuni* cfu/mL and stored at 4°C, the organism survived 6–21 days (Christopher et al., 1982; Doyle and Roman, 1982a; Wyatt and Timm, 1982). However, when this work was repeated using more realistic levels of 1–10 *C. jejuni* cfu/mL, the organism survived less than 4 days (DeBoer et al., 1984), which emphasizes the difficulty in recovering *Campylobacter* from raw milk. In similar studies using pasteurized milk, *C. jejuni*

persisted somewhat longer because there was less microbial competition and slower acid development (Blaser et al., 1980; Christopher et al., 1982; Doyle and Roman, 1982b). However, *Campylobacter* viability decreased rapidly at higher storage temperatures with this pathogen no longer being detected in pasteurized or sterilized milk after 3 days of storage at 20–25°C. Similar survival has been reported for *C. jejuni* in raw and pasteurized goat's milk (Simms and MacRae, 1989).

Campylobacter is far more sensitive to heat, acid ($\text{pH} \leq 5$), oxygen, ambient temperatures, dehydration, chlorine- and iodine-based sanitizers, and the raw milk environment than most other milkborne pathogens (Koidis and Doyle, 1984; Wyatt and Timm, 1982). Consequently, *C. jejuni* is rapidly inactivated during the cooking step in cottage cheese (Ehlers et al., 1982) and Swiss cheese (Bachmann and Spahr, 1995) manufacture. Furthermore, when Cheddar cheese was prepared from pasteurized milk inoculated to contain 10^2 – 10^6 *C. jejuni* cfu/mL, the organism was no longer recoverable from the cheese (pH 5) beyond 15 days of curing (Ehlers et al., 1982). Limited survival of *Campylobacter* in Cheddar cheese is also supported by an earlier survey in which 127 samples of 60-day-old Cheddar cheese (Brodsky, 1984b) and 140 samples of French raw milk cheese (Federighi et al., 1999) tested negative for *C. jejuni*. The only evidence of cheese contamination comes from Wegmuller et al. (1993), who detected DNA from *C. jejuni* in three raw milk cheeses using a polymerase chain reaction method. However, inability to culture *C. jejuni* from these cheeses suggests that the organisms were no longer viable. Given these findings along with absence of any reported cheese-associated cases of campylobacteriosis and lack of any supportive epidemiological evidence (Harris et al., 1986), cheese appears to be a highly improbable vehicle for *Campylobacter* enteritis.

6. Prevention

Proper vat (61.7°C/30 min) and high-temperature, short-time pasteurization (71.7°C/15 s) offer complete protection against spread of milkborne campylobacteriosis even if impossibly high populations of *C. jejuni* were present in raw milk to be pasteurized (D'Aoust et al., 1988; Gill et al., 1981; Waterman, 1982). Even though *Campylobacter* spp. are unable to grow in refrigerated raw milk, the organism can persist for several days or more at levels sufficient to induce illness. Because most milkborne campylobacteriosis outbreaks have been linked to consumption of raw milk, milkborne *Campylobacter* enteritis can be easily avoided by consuming only pasteurized milk. However, since many of the reported campylobacteriosis cases are among children, individuals involved in youth activities and school field trips must be alert to the danger of raw milk if free samples are offered.

F. Drug Residues

Emphasis on increased milk production over the past 50 years has fostered the use of many antibiotics including the β -lactams, tetracyclines, and sulfonamides for treating mastitis and other diseases in dairy cattle. As of May 1992, at least 60 different animal drugs were approved for use (Anonymous, 1992). However, at the same time, 52 non-FDA approved, residue-producing drugs were also suspected of being used illegally. Regardless of the route of administration (i.e., oral, injection, infusion), these antibiotics enter the bloodstream to produce their desired effect at the point of infection and are then metabolized and excreted by the animal at various rates. The FDA has established legally binding limits for at least 16 animal-approved drugs and has also set drug withdrawal periods ranging from a few hours to several weeks, during which time, milk from treated cows must be discarded. Shortened milk withdrawal or discard periods can lead to potentially unsafe drug residue levels in milk. Because milk from various farms is typically commingled, unsafe or illegal animal drug residues can contaminate large volumes of milk, with the FDA estimating that milk from a single sulfamethazine-treated cow can contaminate milk from 70,000 cows when pooled (Anonymous, 1992). Two widely publicized 1989 surveys published in *The Wall Street Journal* highlighted the scope of this problem with 20 and 38% of the retail milk samples tested containing animal drug residues and other nonapproved drugs (Place, 1990).

1. General Characteristics

Testing milk for presence of antibiotic residues in the United States began in 1953 after a revision of the Pasteurized Milk Ordinance to prohibit sale of milk containing antibiotics (Anonymous, 1990). Since those early days, β -lactam antibiotics have been the traditional target of state and federally regulated fluid milk testing programs. However, results from a widely publicized 1988 survey raised concerns regarding numerous other drugs and drug residues in the milk supply, with sulfonamides and tetracyclines also attracting considerable attention.

The β -lactam antibiotics include penicillins and cephalosporins, both of which consist of a thiazolidine and β -lactam ring with the latter containing various side chains. Penicillin G has traditionally been the most common drug residue found in milk owing to the popularity of use of this drug on the farm. The level and duration of β -lactam residues in milk are affected by both route of administration and number of antibiotics administered (Oliver et al., 1990). When injected, less than 0.3% of the drug appears in milk. However, treatment of mastitis by intramammary infusion leads to almost total excretion in milk. Most reports suggest that penicillin G and its derivatives are relatively resistant to heat with vat and high-temperature, short-time pasteurization reducing antimicrobial activity in milk less than 10% (Moats, 1988). Penicillin also has the distinction of being

the most allergenic drug known, with approximately 10% of the human population reportedly being sensitive (Olson and Sanders, 1975). Because several early reports traced allergic dermatitis to tainted milk (Erskine, 1958), a maximum legal limit of 0.01 ppm has been established for penicillin in fluid milk (Anonymous, 1990).

The sulfonamides, another important group of antimicrobials, have been used to treat systemic and cutaneous infections in farm animals for more than 50 years. All sulfonamides are derivatives of sulfanilamide and ultimately inhibit nucleic acid synthesis. Although available without prescription, the sulfonamides, except sulfadimethoxine, sulfabromomethiazine, and sulfaethoxypyridazine, cannot be used to treat disease in lactating animals (Charm et al., 1988). The latter antimicrobial has a zero tolerance in milk and the former two have a 10-ppb tolerance. Like penicillins, sulfonamides are also resistant to most food processing conditions, with activity being retained during prolonged heating (Moats, 1988). Sulfonamides are somewhat less allergenic than penicillin, with approximately 3.4% of the population being sensitive (Bigby et al., 1986). However, one particular sulfonamide banned for use in lactating dairy cattle, namely, sulfamethazine, is a suspected human carcinogen based on animal studies (Anonymous, 1990). Considerable public concern was raised in 1988 when trace levels of sulfamethazine were detected in the United States milk supply (Anonymous, 1990). The estimated maximum allowable level of 1–5 ppb sulfamethazine in milk will likely preclude any practical use of this drug in dairy cattle.

In the United States, a highly diverse group of at least 60 FDA-approved and 52 non-FDA-approved drugs were being administered, often illegally, to dairy herds, with 64 of these drugs leaving residues of concern in milk (Anonymous, 1990). Other antibiotics commonly encountered in the United States milk supply include tetracycline, aminoglycosides, cephalosporins, and chloramphenicol (Brady and Katz, 1988; Kaneene and Miller, 1992). Penicillins remain the drug of choice in treating bovine mastitis followed by cephalosporin, aminoglycosides, novobiocin, and erythromycin, with these five antibiotics accounting for greater than 90% of all drug residues detected in milk. Less frequently encountered antibiotic residues in milk include chlorotetracycline, tetracycline, oxytetracycline, gentamicin, dihydrostreptomycin, and chloramphenicol (Anonymous, 1990). Consumer-safe levels for most of these antibiotics have not yet been established, with the United States generally advocating a policy of zero tolerance.

2. Detection Methods

Current strategies for detecting antibiotic residues in milk have evolved over the last 50 years; the earliest methods were based on the inability of test bacteria to produce acid, reduce dyes, or grow on solid media in the presence of antibiotics

(Bishop and White, 1984). These time-consuming assays, which required overnight incubation, were eventually replaced by the qualitative and quantitative *Bacillus stearothermophilus* disc assays for penicillin and other inhibitors. Both of these AOAC-approved tests are based on measurable inhibition zones that develop around filter paper discs impregnated with the test sample within 3 h of incubation at 64°C (Bishop et al., 1992; Richardson, 1990). A variation of this assay known as the Delvotest-P (Bishop et al., 1992; Bishop and White, 1984) is even more sensitive for penicillin and uses the pH indicator bromocresol purple to assess acid production by *B. stearothermophilus*. The widely acclaimed and AOAC-approved Charm test, first introduced in 1978, is based on competitive binding of radioactively labeled penicillin (and later tetracycline, erythromycin, streptomycin, novobiocin, sulfamethazine, and chloramphenicol) to vegetative cells of *B. stearothermophilus*. At least seven different versions of this assay are known, three of which have been simplified for on-farm testing (Bishop et al., 1992). In addition, at least six different enzyme-linked immunosorbent assays covering most other antibiotics of interest are available (Bishop et al., 1992). However, these newly developed rapid methods and several others based on agglutination of antibiotic-coated latex beads, high-performance liquid chromatography, and reduction of brilliant black dye have not yet received AOAC approval. Consequently, the aforementioned qualitative and quantitative *B. stearothermophilus* disc assay and Charm tests remain the methods of choice for most commonly encountered antibiotics.

3. Risks of Drug Residues

The public health significance of barely detectable levels of animal drug residues in the milk supply is still somewhat controversial. Several international studies have concluded that small amounts of drug residues in milk are not likely to pose a significant human health hazard, with bacterial pathogens clearly constituting a far more serious threat (Anonymous, 1990). However, as previously discussed, ingesting antimicrobials such as penicillin, streptomycin, tetracycline, aminoglycosides, and sulfonamides in food can produce life-threatening allergic reactions, including anaphylactic shock in susceptible individuals (Anonymous, 1990). Given the current long life expectancy of humans, increased suppression of the human immune system through long-term exposure to low levels of antibiotics in the milk supply is also a growing concern. At least two drugs used in treating dairy cattle, namely, sulfamethazine and nitrofurazone, also can produce cancer in laboratory animals and, as such, are potential human carcinogens (Anonymous, 1990). Other commonly used drugs, including chloramphenicol and ivermectin (an antiworming agent), have been associated with aplastic anemia (an irreversible and potentially fatal bone marrow disease) and various neurological disorders.

A separate rapidly emerging public health issue relates to development of new antibiotic-resistant bacterial pathogens such as *Salmonella* and *Campylobacter* as a result of long-term exposure to low levels of antibiotics in milk through subtherapeutic doses in animal feed. In 1985, the second largest known foodborne outbreak involving more than 16,000 cases of salmonellosis in the Chicago area was traced to pasteurized milk that contained a very rare multi-antibiotic-resistant strain of *S. Typhimurium* (Ryan et al., 1987). The fact that this organism also contained several plasmids encoding resistance to 14 different antibiotics (Schuman et al., 1989), eight of which were commonly encountered as drug residues in milk (Anonymous, 1992a), highlights the potential danger of antibiotic misuse on the farm.

Contamination of milk with even minute levels of antibiotics also has created several potential safety-related problems for manufacturers of fermented dairy products, including inadequate milk clotting and improper cheese ripening, inadequate acid and flavor development in buttermilk, invalid results from certain quality control tests, and, most importantly, diminished starter culture growth and acid production during cheese making, which can allow pathogens such as *Salmonella* and *Staphylococcus aureus* to grow (Park and Marth, 1972b). Starter culture failure remains a major cause of disease outbreaks involving cheese and other fermented dairy products.

4. Occurrence

Antibiotic residues were relatively common in the United States milk supply as recently as the late 1980s. In a nationwide survey, Collins-Thompson et al. (1988) detected sulfamethazine and tetracycline in 47 and 28%, respectively, of samples tested from 16 states, with penicillin, erythromycin, chloramphenicol, and novobiocin found in less than or equal to 5% of samples. Furthermore, each state yielded samples containing one or more antibiotic residues, with similar findings obtained from 40 retail milk samples collected in four Canadian provinces.

When 64 retail milk samples from eastern Pennsylvania, central New Jersey, and the New York City area were screened, Brady and Katz (1988) found antibiotics in 63% of the samples with 43 and 17% of positive samples containing residues of two and four or more antibiotics, respectively. Sulfonamides and tetracyclines were the most prevalent residues with each present in nearly 40% of the samples tested. Thirty-eight percent of samples contained both sulfonamide and tetracycline with 16% containing both sulfonamides and streptomycin. Chloramphenicol, erythromycin, and β -lactams were identified in 10, 5, and 2%, respectively, of the samples.

According to Charm et al. (1988), 71% of retail and tanker truck milk samples tested in the northeast United States were contaminated with sulfonamides at levels of at least 5 ppb. Half of the positive samples contained greater

than 25 ppb sulfonamide, with one sample having 15,000–20,000 ppb. Sulfamethazine was the dominant sulfonamide detected and was sometimes present at levels as high as 40 ppb, which is eight times higher than the maximum allowable level suggested by the FDA. In another survey involving retail milk from 10 major United States cities, sulfonamides were detected in 36 of 49 samples, with most positive findings coming from the northwest and northeast (Charm et al., 1988). However, in Prince Edward Island, Canada, where sulfonamides are not sold over the counter, 1000 tanker truck samples tested negative for these drugs.

Much of the controversy concerning the public health significance of antibiotic residues in milk is based on wide disparities between results from regulatory and nonregulatory surveys and a lack of firmly established tolerance levels for many antibiotics. In 1990, the FDA compiled test results from more than 1.4 million bulk tank samples representing 43% of the United States milk supply and reported that only 0.27 and 0.09% of these samples contained unsafe levels of β -lactam antibiotics and sulfamethazine, respectively (Anonymous, 1990). These low contamination rates decreased even further during 1994 and 1995 with illegal levels of β -lactam antibiotics, sulfonamides, sulfamethazine, and tetracycline, present in only 0.15, 0.13, 0.007, and 0.12%, respectively, of the milk supply (Anonymous, 1996). In tests conducted during fiscal 1997–1998 (Anonymous, 1999), over 4.6 million samples of fluid milk (raw and pasteurized) and other dairy products were examined for 18 different drugs. Overall, 0.10% of these samples were positive for drug residues compared to 0.11 and 0.12% during fiscal 1996–1997 and 1995–1996, respectively. Of the 4511 positive samples identified during 1997–1998, only 3 (0.06%) samples were classified as pasteurized fluid milk or dairy products. Among positive raw milk samples, two-thirds of which originated from bulk milk pickup tankers, 96.7% contained β -lactams with 1.75 and 0.88% positive for tetracyclines and sulfonamides, respectively. However, when compared with bacterial pathogens, these low background antibiotic residue levels pose a negligible public health risk to consumers.

5. Prevention

During the 1980s, faulty dairy herd management practices, including insufficient knowledge concerning milk withdrawal periods, inadequate record keeping on mastitic cows, and inappropriate use of antibiotics, were cited as being primarily responsible for the high incidence of antibiotic residues in the milk supply (Kaneene and Ahl, 1987). In response to these findings, the FDA and the dairy industry adopted a joint three-point program to (a) reevaluate antibiotic detection methods for adequacy and efficiency, (b) implement a public awareness program to accurately inform consumers about the safety of the milk supply, and (c) develop a 10-point Hazard Analysis Critical Control Point (HACCP)-based animal drug

education program for dairy farmers (Adams, 1994). The latter program focuses on proper use of FDA-approved drugs under a veterinarian's supervision, animal treatment records, employee education, and ongoing drug residue screening programs (Adams, 1994). These efforts appear to have been highly successful given the recent sharp decrease in antibiotic-positive milk samples.

G. Enteropathogenic *E. coli*

Bacterium coli commune, known as *Escherichia coli*, was first described by Theodor Escherich in 1885. Most *E. coli* strains are harmless commensals common to the intestinal tract of humans and animals. Some milkborne strains of *E. coli* were thought to be responsible for summer diarrhea in children as early as 1900 (James, 1973). However, bacteriological confirmation of such strains did not come until the 1940s when Bray (1945), Bray and Beavan (1948), and later Brown and Bailey (1958) identified several serologically distinct "enteropathogenic" *E. coli* strains responsible for infant diarrhea. Based on distinct virulence properties, different interactions with the intestinal mucosa, distinct clinical symptoms, differences in epidemiology, and variations in O (somatic) and H (flagellar) antigens, more than 60 distinct strains causing different forms of diarrhea in humans have been identified (Hitchens et al., 1995). These strains are grouped into the following five categories: classic enteropathogenic *E. coli* (EPEC), enterotoxigenic *E. coli* (ETEC), enteroinvasive *E. coli* (EIEC), enterohemorrhagic *E. coli* (EHEC), and, most recently enteroadherent, *E. coli* (EAEC). Both EIEC and ETEC have been linked to major cheese-related outbreaks in the United States and Europe (MacDonald et al., 1985; Marier et al., 1973), and both are discussed in this section as is EPEC, which is a major problem in less developed countries., EAEC is a newly developed and consequently poorly understood category. EHEC, which has recently emerged as a particularly hazardous food-borne pathogen of major public health concern, is discussed separately.

1. General Characteristics

A species in the family Enterobacteriaceae, *E. coli* is a short, gram-negative, facultatively anaerobic, rod-shaped bacterium that may be nonmotile or motile by peritrichous flagella. Most isolates grow optimally at or near 37°C, with growth ceasing at a_w values less than 0.95. Identification of *E. coli* is based on fermentation of glucose and other carbohydrates to acid (lactic, acetic, formic) and gas (CO₂, H₂). Whereas most *E. coli* isolates ferment lactose to acid and gas within 48 h, some strains (particularly those of EIEC) are weakly lactose positive or lactose negative (Hitchens et al., 1998). Important biochemical tests for routine confirmation of *E. coli* include production of indole (usually indole [I] positive), production of stable acid endproducts from glucose (methyl red [M] positive),

production of acetoin from glucose (Voges-Proskauer [Vi] negative), and use of citrate (citrate [C] positive). About 95% of all *E. coli* are IMViC⁺⁺⁻⁻, with the remaining 5% of strains being IMViC⁻⁺⁺⁺ (Doyle and Padhye, 1989). Further characterization and identification of potentially pathogenic strains is partially based on serology with 173 O (somatic) 56 H (flagellar), and 80 K (capsular) antigens yielding an estimated 50,000–75,000 serotypes of *E. coli* (Orskov and Orskov, 1992).

ETEC produces a heat-labile enterotoxin (LT) which is immunologically related to cholera toxin and sometimes a second heat-stable enterotoxin (ST) of low molecular weight (Doyle and Padhye, 1989; Gyles, 1992). The ETEC strains also produce membrane-bound colonization factors that mediate attachment of the organism to the intestinal wall. Sixteen ETEC serotypes comprising 14 different O serogroups are presently known (Hitchins et al., 1998).

EIEC are *Shigella*-like organisms capable of invading and proliferating in the intestinal epithelium, with such invasive ability being plasmid mediated (Doyle and Padhye, 1989). Eleven serotypes comprising eight different O serogroups are presently recognized (Hitchins et al., 1998).

EPEC are defined as diarrheagenic strains belonging to serogroups epidemiologically incriminated as pathogens but whose pathogenicity has not been positively linked to production of heat-labile enterotoxins, heat-stable enterotoxins, *Shigella*-like invasiveness (Edelman and Levine, 1983), or verocytotoxin production (Doyle and Padhye, 1989), the last of which is characteristic of EHEC. Twenty-nine serotypes of EPEC comprising 15 different O serogroups are recognized with some EPEC serotypes being mainly associated with infant diarrhea.

2. Isolation and Detection Methods

Procedures for detecting diarrhea-causing strains of *E. coli* in dairy products generally begin with a 3-h/35°C preenrichment in brain heart infusion broth to resuscitate injured cells (Hitchins et al., 1998). This step is followed by 20 additional hours of incubation at 44°C, which selects for fecal coliforms, including *E. coli*. Thereafter, plates of several standard plating media (i.e., eosin–methylene blue agar and MacConkey agar) are streaked, incubated, and examined for typical and atypical (non–lactose fermenting) *E. coli*. Following standard biochemical confirmation, commercially available antisera that react with many pathogenic serogroups of *E. coli* can be used to screen for the most common, potentially pathogenic strains. However, because pathogenicity cannot be completely correlated with specific O antigens, actual proof of the pathogenicity of the strain is required.

Production of LT and ST toxins by ETEC can be demonstrated using the Y-1 mouse adrenal cell test and the infant mouse test (Doyle and Padhye, 1989; Hutchins et al., 1995), respectively, or by using one of several immunological

or DNA probe-based assays (Doyle and Padhye, 1989; Hill et al., 1998; Tsen et al., 1996). Invasiveness of EIEC isolates is typically shown using HeLa cell cultures or the guinea pig-based Sereny test. Virulent *E. coli* strains not conforming to ETEC, EIEC, or EHEC are likely EPEC. However, because no standard pathogenicity tests for such strains are available, confirmation of most suspect EPEC isolates requires complete serotyping by a qualified *E. coli* reference laboratory.

3. Clinical Manifestations

EPEC is principally responsible for infantile diarrhea, a clinically severe illness in children younger than 2 years of age which is characterized by fever, vomiting, abdominal pain, and a persistent diarrhea that may last for several weeks (Escheverria et al., 1987; Levine, 1987). In adults, EPEC foodborne infections are typically far less severe. Symptoms begin 17–72 h after exposure and include a severe watery diarrhea with mucus, which is frequently accompanied by nausea, vomiting, abdominal cramps, headache, fever, and chills (Doyle and Padhye, 1989). Unlike infantile diarrhea, this illness is of far shorter duration in adults, with spontaneous recovery occurring within 6–72 h.

Widely known as traveler's diarrhea, ETEC gastroenteritis may vary from a mild, 1-day illness consisting of loose stools, abdominal cramps, vomiting, and low-grade fever to a severe cholera-like illness lasting several weeks in which profuse rice water-like stools can lead to serious dehydration (Kantor, 1986). Human volunteer studies (DuPont et al., 1971; Levine et al., 1977) demonstrated an unusually high infectious dose with ingestion of 10^8 – 10^{10} ETEC cells required to produce symptoms within 8–44 h. Most individuals stop shedding ETEC 4–5 days after cessation of diarrhea. Traveler's diarrhea is typically mild and self-limiting. However, in severe cases of ETEC gastroenteritis resembling cholera, fluids are normally given either orally or intravenously to prevent dehydration (Kantor, 1986). Antibiotic therapy is inappropriate and can even be harmful.

EIEC penetrates and destroys the mucosal tissue of the colon to produce an illness indistinguishable from shigellosis (bacillary dysentery) (Gray, 1995). Symptoms typically develop 8–24 h after receiving a minimum oral infectious dose of at least 10^6 EIEC cells (DuPont et al., 1971) and include severe diarrhea accompanied by chills, fever, headache, muscle pain, and abdominal cramps. Unlike profuse watery stools observed in ETEC traveler's diarrhea, stools produced by EIEC are less frequent but typically contain blood, mucus, and leukocytes. However, as in traveler's diarrhea, EIEC infections are normally acquired abroad by adults who recover spontaneously without medical intervention.

4. Outbreaks

Global importance of *E. coli* as a cause of diarrheal illness has decreased markedly over the past 50 years following implementation of improved sanitary prac-

tices. Although still a major cause of waterborne diarrhea in less-developed countries, dairy-related cases of *E. coli* enteritis are uncommon in industrialized countries, with only two outbreaks and two additional cases thus far reported.

Evidence for possible involvement of EPEC in milkborne enteritis is limited to one report from England (Anonymous, 1976) in which two 6-month-old infants developed EPEC infantile diarrhea after ingesting raw milk from their father's farm. EPEC O26 was detected in both stool samples and in milk from one mastitic cow supplying the family. After both infants began drinking bottled pasteurized milk, the illness reportedly disappeared.

In the first of two multistate cheese-related outbreaks (Francis and Davis, 1984; Levy, 1983; MacDonald et al., 1985), symptoms of ETEC gastroenteritis developed in 45 individuals in Washington, DC, 1–6 days after ingesting imported French Brie cheese. Investigators eventually isolated ETEC O27:H20 (an ST-producing strain) from stool samples and the incriminated cheese. After much publicity, 124 additional cheese-related cases were soon confirmed in Colorado, Georgia, Illinois, and Wisconsin, after which the implicated cheese was recalled nationwide. Identical outbreaks involving the same brand of cheese were simultaneously reported in Denmark, Sweden, and the Netherlands. Although the source of contamination at the cheese factory was never found, illness caused by this epidemic strain was linked to two different cheese lots manufactured 46 days apart, thus suggesting a recurrent contamination problem.

During 1971, imported French Brie cheese was identified as the vehicle of infection in a second multistate outbreak of EIEC gastroenteritis, which also began in Washington, DC (Barnard et al., 1971; Marier et al., 1973; Schnurrenberger and Pate, 1971; Tulloch et al., 1973). A total of 347 cases of diarrhea in Washington, DC, were eventually linked to ingesting imported French Brie, Camembert, and Coulommiers cheese containing high coliform populations and EIEC O124:B17 at a level of 10^5 – 10^7 organisms/g, with growth of the organism during cheese ripening being suspected (Fantasia et al., 1975). Twelve people required hospitalization and were later released. As in the previous outbreak, the epidemic strain was recovered from both stool and cheese samples. The importer subsequently recalled all lots (1200 lb) of cheese that were distributed. EIEC O124:B17 was later recovered from samples of partially consumed cheese that were originally manufactured over a 13-day period, thus suggesting an ongoing contamination problem that was likely related to inadequate filtration of river water used in factory cleaning operations.

5. Occurrence and Survival in Dairy Products

EPEC, ETEC, and EIEC are classified as fecal coliforms with their presumed primary reservoir being the intestinal tract of humans and animals. However, these organisms are occasionally found in raw milk from normal and mastitic

cows. In early eastern European surveys, pathogenic *E. coli* serotypes were identified in less than 2% of the raw milk supply (Bryan, 1983). More recently, 3 of 47 raw milk samples tested in Iowa harbored EPEC serotypes (Glatz and Brudvig, 1980). Pathogenic serotypes of *E. coli* have been seldom identified in pasteurized milk and cream (Jones et al., 1967); however, ETEC can grow in inoculated sterile milk at ambient temperatures and produce small amounts of LT (Olsvik and Kapperud, 1982).

Despite two large cheese-related outbreaks of gastroenteritis, pathogenic serotypes of *E. coli* are rarely found in cheese marketed in the United States with only one documented report involving Mexican-style fresh white cheese contaminated with ETEC, which was detected during a routine surveillance program and recalled without incident (Anonymous, 1991a). According to Frank and Marth (1978), 106 samples of Camembert, Brie, brick, Muenster, and Colby cheese purchased in Wisconsin tested negative for common EPEC serotypes. Whereas 78 cheese samples tested in Iowa were also negative for ETEC (Glatz and Brudvig, 1980), contamination rates are considerably higher in less developed countries such as Iraq, Abbar, and Kaddar (1991), as well as India (Singh and Ranganathan, 1974), where acute *E. coli* gastroenteritis is common in children.

The fate of any organism in cheese is dictated by many interacting factors, including type of cheese, initial populations in milk, strain differences, amount and type of starter culture, cheese-making procedures (e.g., cooking, washing), pH, salt content, and location of the organism in cheese as well as temperature and length of ripening and storage. Frank and Marth (1977a, 1977b) examined the fate of ETEC and EIEC in skim milk that was fermented with 0.25–2.0% lactic starter culture at 21 and 32°C for 15 h and then refrigerated at 7°C. Growth of ETEC and EIEC generally ceased at pH 4.8–5.2, with the combination of low incubation temperature and highest starter inoculum being most detrimental to growth and survival. ETEC and EIEC survival was also influenced by type of starter culture with *Lc. lactis* subsp. *lactis* being least inhibitory followed by *Lc. lactis* subsp. *cremoris* and a mixture of both organisms.

The 1971 outbreak involving Brie cheese prompted several studies that examined the fate of EIEC and ETEC in various cheeses prepared from pasteurized milk inoculated to contain 100–1000 organisms/mL. When Camembert cheese was manufactured (Frank et al., 1977), EIEC and ETEC populations increased approximately 100-fold during the first 6 h of cheese making until the curd attained a pH less than or equal to 5. Both types of *E. coli* were slowly inactivated in the cheese during ripening at 12 and later 7°C, with EIEC and ETEC surviving 1 week and 1–6 weeks, respectively. However, rapid growth of EIEC and ETEC to levels of 10⁵ organisms/g was observed when cheeses were surface inoculated 5 days after manufacture and similarly ripened, with both organisms persisting well beyond the normal shelf life of the cheese. In Colby-like

cheese (Kornacki and Marth, 1982), *E. coli* populations increased 100- to 1000-fold during the first 4 h of cheese making, with EIEC and ETEC persisting 4 and greater than 12 weeks, respectively, in finished cheese ripened at 4–10°C. These *E. coli* strains behaved similarly during manufacture of brick cheese (Frank et al., 1978), with ETEC again proving to be hardier than EIEC in 7-week-old brick cheese.

To simulate postmanufacturing contamination, Sims et al. (1989) inoculated commercially prepared cottage cheese (pH 4.7–4.9) to contain 10⁴ ETEC/EIEC cfu/g and incubated the product at 7–25°C. Regardless of storage temperature, *E. coli* levels decreased only slightly during the 14-day shelf life of the product.

6. Prevention

Human carriers are presumed to be the primary reservoir and source of ETEC, EIEC, and EPEC. Because *E. coli* is readily destroyed by pasteurization with a wide margin of safety, the organism typically enters the product as a postpasteurization contaminant. Dairy products are most often contaminated by infected food handlers who practice poor personal hygiene or by contact with water containing human sewage. Consequently, food workers must be educated in safe food-handling techniques and proper personal hygiene practices including hand washing after using the lavatory.

H. Enterohemorrhagic *E. coli* O157:H7

In 1982, outbreaks of hemorrhagic colitis in Oregon and Michigan drew attention to an unusual clinical syndrome of gastroenteritis caused by a little known enteric bacterial pathogen, namely, enterohemorrhagic *E. coli* (EHEC) O157:H7—a serotype identified only once 7 years earlier at the Centers for Disease Control from a single case of human diarrheal illness (Riley et al., 1983; Wells et al., 1983). A total of 47 cases of hemorrhagic colitis were identified in these two outbreaks, with undercooked hamburgers subsequently identified as the vehicle of infection. Numerous outbreaks of *E. coli* O157:H7 infection were later linked to consumption of such products as undercooked ground beef (Hancock et al., 1994), apple cider (Besser et al., 1993; Steele et al., 1982), and mayonnaise (Borczyk et al., 1987; Neill, 1989), and this pathogen once again gained considerable notoriety in 1993 after more than 500 hamburger-related cases of illness and the deaths of four children were reported (Conner and Kotrola, 1995; Knight, 1994; Wuethrich, 1994) in Washington, Idaho, California, and Nevada (Anonymous, 1993b; Anonymous, 1994a; Hancock et al., 1994). The seriousness of these aforementioned outbreaks, combined with an estimated 62,000 cases and 50 deaths occurring annually in the United States (Mead et al., 1999) along with additional sporadic

cases reported in Canada (Lior, 1994b) and elsewhere (Griffin and Tauxe, 1991) have raised *E. coli* O157:H7 to a foodborne pathogen of international importance (Knight, 1993). Of concern to the dairy industry are the presence of *E. coli* O157:H7 in 2–5% of the raw milk supply (D'Aoust, 1989; Wells et al., 1991) and reports of over 60 cases of raw milk-associated illness.

1. General Characteristics

Verotoxigenic *E. coli*, or EHEC, produces one or two verotoxins, designated VT-1 and VT-2, which are toxic to Vero (African green monkey kidney) and HeLa cells, as first reported by Konowalchuk et al. (1977). VT-1 is a relatively heat-stable, high molecular weight, Shiga-like toxin, whereas VT-2 is immunologically distinct (Doyle, 1991).

Six EHEC serogroups, O26, O48, O111, O113, O145, and O157, have been linked to human illness (Goldwater and Bettelheim, 1995; Hitchins et al., 1998), with additional verotoxigenic serogroups detected in both healthy cattle (Montenegro et al., 1990; Wells et al., 1991) and cattle with diarrhea (Mohammad et al., 1986). In all, more than 80 serotypes of EHEC are recognized (Griffin and Tauxe, 1991), with O157:H7 being dominant in the United States and Canada (Lior, 1994b) and O111:H⁻ being particularly common in Australia (Goldwater and Bettelheim, 1995). However, because *E. coli* O157:H7 is the best established foodborne pathogen among the EHEC, this discussion will be confined to *E. coli* O157:H7.

E. coli O157:H7 is similar to most other *E. coli* with a few important exceptions (Doyle, 1991; Gray, 1995). Whereas *E. coli* O157:H7 grows optimally at 30–42°C, this serotype grows poorly, if at all, at 44–45.5°C (Buchanan and Klawitter, 1992; Doyle and Schoeni, 1984) and is therefore unlikely to be recovered when samples are analyzed for fecal coliforms. Growth of *E. coli* O157:H7 has been reported in milk at temperatures as low as 5.5°C, with the growth rate being inversely related to numbers of background organisms (Kauppi et al., 1996; Massa et al., 1999; Palumbo et al., 1997; Wong et al., 1997). However, addition of 4% sodium lactate to tryptic soy broth permits growth at 4°C to levels of 10⁸ organisms/mL after a lag period of 4 weeks (Conner and Hall, 1996). Biochemically, *E. coli* O157:H7 generally lacks the enzyme glucuronidase, which is possessed by 92–96% of all other *E. coli* strains, and, unlike 80–93% of other *E. coli* strains, is unable to ferment D-sorbitol within 24 h. Both of these biochemical differences are of major importance in screening samples for *E. coli* O157:H7.

2. Isolation and Detection Methods

Selective recovery of *E. coli* O157:H7 from food samples is based on inability of typical isolates to ferment sorbitol and hydrolyze 4-methyl-umbelliferyl β-D-

glucuronide (MUG) to a fluorogenic product. However, a few strains are positive for sorbitol and MUG (Gunzer et al., 1992). Direct plating media commonly used at 37°C include sorbitol MacConkey agar (SMAC) with and without MUG (Hitchins et al., 1998; McCleery and Rowe, 1995) and hemorrhagic colitis agar, which contains both sorbitol and MUG (Hitchins et al., 1998). Several selective enrichment broths containing novobiocin or other antibiotics also can be used to enhance recovery (Padhye and Doyle, 1992). In one recently reported FDA procedure (Hitchins et al., 1998; Weagant et al., 1998), samples were enriched at 37°C for 7 h in tryptic soy broth containing vancomycin, cefsulodin, and cefixime and then plated on SMAC supplemented with tellurite and cefixime. Presumptive *E. coli* O157:H7 isolates must be serologically confirmed using either commercially available antisera or a serotype-specific DNA probe in a colony hybridization assay (Hill et al., 1998). Verotoxin production by non-*E. coli* O157:H7 strains can be confirmed using traditional cell culture techniques or the newly developed DNA probe and polymerase chain reaction assays for VT-1. However, identification of other verotoxin-producing strains is infrequent because most such isolates are positive for both sorbitol and MUG (Wells et al., 1991).

3. Clinical Manifestations

Compared to most other foodborne illnesses, infections involving *E. coli* O157:H7 or other EHEC strains are particularly serious, with manifestations ranging from a mild, nonbloody diarrhea to hemorrhagic colitis, hemolytic uremic syndrome, and thrombotic thrombocytopenic purpura, all of which are related to adherence of the pathogen to the intestinal tract lining followed by production of one or more verotoxins (Gray, 1995; Griffin and Tauxe, 1991; Griffin et al., 1988; Padhye and Doyle, 1992; Riley et al., 1983). Furthermore, the oral infectious dose may be relatively low, with fewer than 1000 organisms inducing illness.

Hemorrhagic colitis is characterized by sudden onset of severe appendicitis-like abdominal pain followed by watery and eventually grossly bloody diarrhea described as "all blood and no stool." Vomiting may occur but, unlike in EIEC infections, fever is typically mild or absent. The incubation period ranges from 3 to 5 days, with symptoms generally persisting 2–9 days. However, fecal shedding of the organisms has been reported for up to 4 weeks. This type of infection is typically self-limiting in adults, with antibiotic therapy being of limited value in shortening the duration of bloody diarrhea.

The second manifestation, hemolytic uremic syndrome, develops in 2–7% of patients with hemorrhagic colitis and is the leading cause of acute renal failure in children (Karmali et al., 1983). This condition is characterized by hemolytic anemia (intravascular coagulation of erythrocytes), thrombocytopenia (low levels of circulating blood platelets), and kidney failure, which occurs in otherwise

healthy individuals. Patients frequently require kidney dialysis and blood transfusions and a number of complications may develop including heart failure, seizures, and a prolonged coma, which can be terminal in 3–10% of cases (Gray, 1995).

The third manifestation, thrombotic thrombocytopenic purpura, which usually occurs in adults, is similar to hemolytic uremic syndrome except for development of fever. Central nervous system disorders typically dominate, with development of terminal blood clots in the brain also being reported. Hence, unlike many other foodborne illnesses, infections with *E. coli* O157:H7 can be particularly devastating.

4. Outbreaks

Consumption of undercooked ground beef has been the traditional mode for *E. coli* O157:H7 infections; however, illnesses from ingestion of raw milk have been reported, with the number of such cases continuing to increase. In April 1986, a group of 60 kindergarten children visited a dairy farm in Ontario, Canada, and were given raw milk to drink (Borczyk et al., 1987). Subsequently, *E. coli* O157:H7 infections developed in 46 children, three of whom also contracted hemolytic uremic syndrome. *E. coli* O157:H7 was later isolated from 1 of 67 fecal samples collected from healthy calves and cows on the same farm.

Several months later, consumption of raw milk on two Wisconsin farms was linked to separate cases of hemolytic uremic syndrome involving a 13-month-old boy and a 5-month-old girl (Martin et al., 1986). Follow-up screening of fecal samples from dairy cattle on both farms yielded *E. coli* O157:H7 in both herds.

Two separate raw milk-related outbreaks also occurred in Oregon during 1992 and 1993. In the first of these outbreaks (Bleem, 1994), *E. coli* O157:H7 infections developed in nine individuals aged 9 months to 73 years after consuming raw milk. Testing the entire herd of 132 animals revealed four cattle as being positive for *E. coli* O157:H7, including two 15-month-old heifers, one dry cow, and one milking cow. Furthermore, strain-specific typing demonstrated that six of the nine human isolates were identical to the four bovine strains. In the second raw milk-related outbreak (Bleem, 1994), five cases of *E. coli* O157:H7 infection were identified, including two cases of hemolytic uremic syndrome. Subsequent fecal sampling of the entire herd of 60 animals revealed *E. coli* in four postweaned heifers. Subtyping again demonstrated that cattle and human isolates were identical. In addition to these milk-related cases, evidence also exists for direct transmission of *E. coli* O157:H7 between fecal-positive dairy calves and a 13-month-old Canadian boy in whom hemolytic uremic syndrome developed after he was playing in straw bedding near the calves (Renwick et al., 1993).

The risk of acquiring *E. coli* O157:H7 infections through ingestion of raw milk is well documented. Additional cases of illness have been linked to farm-

manufactured yogurt and pasteurized milk involving a verotoxigenic strain of *E. coli* that is closely related to *E. coli* O157:H7. Sixteen cases of *E. coli* O157:H7 infection that occurred in northwest England during 1991 were epidemiologically linked to consumption of farm-produced yogurt (Anonymous, 1991b; Morgan et al., 1993). Eleven of these cases involved children 10 years old and younger; in five of these children hemolytic uremic syndrome developed. Thirteen individuals required hospitalization and all patients eventually recovered. Although the epidemic strain was never isolated from the implicated yogurt or ingredients obtained from the dairy farm, subsequent inspections yielded strong evidence for postpasteurization contamination. During February and March of 1994, acute bloody diarrhea and abdominal cramps developed in 18 individuals from Helena, MT, from infection with a supposedly rare, but closely related (to other EHEC strains) verotoxigenic strain of *E. coli*; namely, *E. coli* O104:H21 (Moore et al., 1995). Epidemiological evidence strongly supported one particular brand of pasteurized milk as the source of infection. Furthermore, company records indicated that coliform counts for at least one of the finished milk products sold during the outbreak exceeded the state allowable maximum level of 10 coliforms per 100 mL of milk. *E. coli* O104:H21 was never recovered from incriminated milk, the factory environment, or its supposed farm source during subsequent investigations. Because the techniques available for identifying non-O157:H7 verotoxigenic strains of *E. coli* are ill defined and not available to most laboratories, these results are not surprising. However, this outbreak does raise serious new public health concerns regarding possible presence of verotoxigenic strains of *E. coli* in factory environments and their entry into finished products as post-processing contaminants.

5. Occurrence and Survival in Dairy Products

The environmental niches for *E. coli* O157:H7 have not yet been clearly established; however, beef and dairy cattle appear to be emerging as a major reservoir for this pathogen. Although an early survey indicated that 2–6% of dairy cows shed *E. coli* O157:H7 in feces (Wells et al., 1991) (also see Chap. 1), the actual shedding rate is now believed to be considerably higher, particularly during the summer months. Although not currently recognized as a cause of mastitis in dairy cattle, *E. coli* O157:H7 can readily contaminate milk on the farm, with contamination rates of 4.2 and 2.0% being reported for raw milk produced in the United States and Canada, respectively (D'Aoust, 1989). However, Padhye and Doyle (1991) found somewhat higher contamination rates, with *E. coli* O157:H7 being present in 10% of raw milk bulk tank samples collected from 69 different Wisconsin farms. Substantial growth of *E. coli* O157:H7 can occur in temperature-abused milk, with this pathogen exhibiting generation times of 7.2 and 1.5 h at 12 and 20°C, respectively.

Current evidence indicates that *E. coli* O157:H7 is not unduly heat resistant and, like most salmonellae, is readily destroyed in milk by minimum pasteurization (71.7°C/15 s) (D'Aoust et al., 1988). One study (Conner and Kotrola, 1995) showed the ability of *E. coli* O157:H7 populations to remain relatively constant in laboratory media acidified to pH 4.7 with lactic acid during 56 days of storage at 4 and 10°C with *E. coli* O157:H7 levels increasing nearly 100-fold in the same medium after 7 days of storage at 25°C. Boor and Dineen et al. (1998) subsequently assessed the ability of *E. coli* O157:H7 to compete with commonly used lactic acid bacteria starter cultures. When pasteurized milk samples were inoculated to contain 10³ *E. coli* cfu/mL and fermented with *Lc. lactis* ssp. *lactis* or *Lactobacillus delbrückii* ssp. *bulgaricus*, the pathogen was completely inactivated within 96 h and was unable to survive a typical yogurt fermentation. However, Massa et al. (1997) reported that *E. coli* O157:H7 survived at least 7 days in similarly prepared yogurt. In contrast, *E. coli* O157:H7 remained viable for 40 days when similar milks were fermented with *Streptococcus thermophilus* and *Lc. lactis* ssp. *cremoris*.

In response to these findings, several studies were also conducted to determine the fate of this pathogen during manufacture and storage of various fermented dairy products. According to Arocha et al. (1992) and Hudson et al. (1997), *E. coli* O157:H7 was completely destroyed during normal cooking of cottage cheese curd at 57°C. However, when Cheddar cheese was prepared from pasteurized milk inoculated to contain 1 *E. coli* O157:H7 cfu/mL, Reitsma and Henning (1996) reported that the pathogen survived cheese making and persisted for 138 days in finished cheese ripened at 6–7°C, well beyond the minimum 60-day curing period at greater than or equal to 1.7°C required by the FDA for Cheddar cheese prepared from raw or heat-treated milk. In another study, Ram-saran et al. (1998) reported limited growth and survival of *E. coli* O157:H7 in both feta and Camembert cheese during 65 and 70 days of ripening, respectively. Looking at *E. coli* O157:H7 as a postmanufacturing contaminant, Kasrazadeh and Genigeorgis (1995) found this organism unable to grow in Hispanic cheese (pH 6.6) during 2 months of storage at 8°C. Whereas growth was observed in temperature-abused cheeses, with *E. coli* O157:H7 exhibiting generation times of 23 and 2.5 h at 10 and 20°C, respectively, such growth could be delayed or prevented by incorporating 0.3% sodium benzoate or potassium sorbate into the cheese. According to Dineen et al. (1998), *E. coli* O157:H7 survived >35, 7–35, and 6–14 days when retail samples of buttermilk, sour cream, and yogurt were inoculated to contain 10²–10³ *E. coli* O157:H7 cfu/g or mL and subsequently stored at 4°C. Given these findings, *E. coli* O157:H7 is likely to persist in other cheeses and fermented dairy products for various times depending on storage conditions. However, in the only survey thus far reported (Bowen and Henning, 1994), 50 retail samples of natural American and non-American-type cheeses purchased in South Dakota failed to yield *E. coli* O157:H7.

6. Prevention

Unlike ETEC, EIEC, and EPEC, which reside in symptomatic and asymptomatic human carriers, *E. coli* O157:H7 is apparently confined to the intestinal tract of cattle and perhaps other animals. Given the probability for contamination of milk during milking, consumption of raw milk should be avoided. If good manufacturing practices are followed, consumption of pasteurized milk poses little risk because *E. coli* O157:H7 is readily inactivated during high-temperature, short-time pasteurization (D'Aoust et al., 1988). However, because this organism is reasonably acid tolerant, raw milk cheeses and soft-ripened cheeses such as Brie and Camembert could pose public health concerns if prepared or aged improperly.

I. Listeriosis

Listeria monocytogenes, the causative agent of listeriosis in humans and animals, was first isolated nearly 75 years ago from blood of infected rabbits exhibiting a typical monocytosis (Murray et al., 1926). However, this bacterium only recently emerged as a serious foodborne pathogen that can cause abortion in pregnant women and meningitis, encephalitis, and septicemia in newborn infants and immunocompromised adults. Unlike most other foodborne illnesses, the outcome of listeric infections can be particularly devastating, with a mortality rate of 20–30%. During the 1980s three major dairy-related outbreaks of listeriosis—two in the United States and one in Switzerland—were linked to consumption of pasteurized milk, Mexican-style cheese, and Vacherin Mont d'Or soft-ripened cheese and resulted in more than 100 deaths (Farber and Peterkin, 1991; Ryser, 1999a). These outbreaks, combined with a presumably low oral infectious dose, prompted the United States to institute a policy of 'zero tolerance' for *L. monocytogenes* in all cooked and ready-to-eat foods, including dairy products. Since 1985, more than 115 class I recalls have been issued for *Listeria*-contaminated dairy products, principally ice cream and cheese, with current financial losses in excess of \$120 million. *L. monocytogenes* accounted for 13 of 18 (72%) dairy-related class I recalls issued during 1994 and 1995, and all 8 dairy-related recalls issued during 1999; thus indicating that *Listeria* contamination within dairy processing facilities has not yet been fully controlled.

1. General Characteristics

The genus *Listeria*, which is included among the coryneform bacteria, contains six species. Although three of these species, *L. monocytogenes*, *L. ivanovii*, and *L. seeligeri*, can cause human or animal infections, only *L. monocytogenes* is important as a foodborne pathogen. *L. monocytogenes* is a gram-positive, non-spore-forming, facultatively anaerobic, short diphtheroid-like, rod-shaped bacte-

rium that occurs singly or in short chains. The organism is psychrotrophic, growing in common laboratory media at temperatures between 1 and 45°C (optimal growth between 30 and 37°C), with growth being enhanced under reduced oxygen conditions (Farber and Peterkin, 1991; Ryser and Marth, 1991; Swaminathan et al., 1995). Characteristic tumbling motility is visible microscopically in broth cultures incubated at room temperature. Colonies on clear media are small, smooth, and blue-gray when examined under obliquely transmitted light. Biochemically, all listeriae produce catalase, ferment glucose to acid without gas, and hydrolyze esculin. Typical *L. monocytogenes* isolates ferment rhamnose but not xylose and are weakly β -hemolytic. *L. monocytogenes* is unusually tolerant of environmental extremes, being able to grow at pH 4.3–10.0, grow in the presence of up to 10% NaCl (a_w 0.92), and survive in refrigerated 25.5% NaCl brine solutions for 4 months (Shahamat et al., 1980). Based on somatic (O) and flagellar (H) antigens, 13 different *L. monocytogenes* serotypes have been identified, with most human illnesses being caused by serotypes 1/2a, 1/2b, and 4b.

2. Isolation and Detection Methods

In the standard FDA protocol (Hitchins 1998), recovery of *Listeria* from dairy products begins with enrichment of the sample in *Listeria* enrichment broth, a buffered medium to which acriflavin, nalidixic acid, and cycloheximide are added later as selective agents. After 24 and 48 h of incubation at 30°C, the enrichment culture is streaked to two different *Listeria* selective plating media including Oxford medium (OXA) and either PALCAM *Listeria* selective agar, which contains polymyxin B, acriflavin, and ceftazidime, or lithium chloride–phenylethanol–moxalactam medium with or without esculin and ferric ammonium citrate (LPM). After 24–48 h of incubation at 30–35°C, suspect colonies on OXA, PALCAM, and LPM are black with a black halo resulting from esculin hydrolysis, whereas colonies on LPM without esculin appear blue-green under oblique lighting. Presumptive *Listeria* isolates are speciated based on a standard series of biochemical tests that can take up to 7 days to complete. However, the time required for biochemical confirmation can be shortened using commercially available test kits (i.e., API 20 S, API-ZYM, API *Listeria*, Micro-ID). Typical *L. monocytogenes* isolates are rhamnose positive, xylose negative, and CAMP test positive with β -hemolysis enhanced in the vicinity of *S. aureus*. Alternatively, several DNA hybridization (Accuprobe, GeneTrak) and enzyme-linked immunosorbent assays (VIDAS) can be used to screen enrichment broths for *Listeria* spp., including *L. monocytogenes* (Hill et al., 1998). Positive test results must be culturally confirmed. Complete serotyping is normally confined to selected isolates of epidemiological importance and conducted by a few select reference laboratories.

3. Clinical Manifestations

Three segments of the population, namely, pregnant women, newborn infants, and immunocompromised adults, are at primary risk of contracting listeriosis, with the latter group including the elderly and other people with predisposing conditions such as cancer, organ transplants, cirrhosis of the liver, human immunodeficiency virus (HIV) infections, or acquired immunodeficiency syndrome (AIDS) (Slutsker and Schuchat, 1999; Swaminathan et al., 1995). In addition to host susceptibility, development of listeriosis in humans is also affected by gastric acidity, inoculum size, strain of *L. monocytogenes*, and various virulence factors of the organism. Whereas the oral infective dose varies widely with healthy individuals rarely being infected, ingestion of foods containing greater than or equal to 10^3 organisms/g poses a significant health risk for susceptible individuals.

Listeric infections in immunocompromised adults typically lead to meningitis, encephalitis, or septicemia (Slutsker and Schuchat, 1999; Swaminathan et al., 1995). Symptoms that develop suddenly after an initial incubation period of 2 days to 3 months include severe headache, dizziness, stiff neck or back, incoordination, and other disturbances of the central nervous system. Without proper antibiotic therapy, 20–30% of those infected will die, with some survivors developing permanent neurologic complications. However, several large foodborne outbreaks of noninvasive gastroenteritis characterized by fever and diarrhea have been documented (Aureli et al., 2000; Dalton et al., 1997). In pregnant women, *L. monocytogenes* produces a mild flu-like illness characterized by sudden chills, fever, sore throat, headache, dizziness, lower back pain, discolored urine, and occasionally diarrhea. Even though expectant mothers almost invariably recover without complications, infection of the fetus can result in abortion, stillbirth, or premature delivery of an infant with perinatal septicemia—a severe infection of the respiratory, circulatory, and central nervous systems that can either terminate fatally or lead to permanent mental retardation.

Two factors, namely, growth of *L. monocytogenes* as an intracellular pathogen within macrophage cells of the spleen and liver and inability of many antibiotics to effectively penetrate the blood-brain barrier, complicate treatment of listeric infections (Slutsker and Schuchat, 1999; Swaminathan et al., 1995). Hence, a favorable prognosis depends on rapid diagnosis and appropriate antibiotic therapy, with oral administration of large doses of ampicillin or penicillin together with an aminoglycoside for 2–4 weeks being the currently recommended treatment.

4. Outbreaks

Early animal feeding studies supported the likely importance of food in disseminating listeriosis (Murray et al., 1926). However, this disease was not linked to consumption of a food product until the early 1950s (Gray and Killinger, 1966;

Ryser, 1999a), with dairy products thus far being responsible for five major outbreaks of listeriosis (Table 5). In the first of these outbreaks, a sharp increase in stillbirths was observed among pregnant women in post-World War II Germany who consumed raw milk, sour milk, cream cheese, and cottage cheese, with approximately 100 *Listeria*-like infections being reported. The eventual isolation of identical *L. monocytogenes* serotypes from a mastitic cow and stillborn twins whose mother consumed the same raw milk before delivery confirmed raw milk as the vehicle of infection (Potel, 1953, 1954). Despite the presence of *L. monocytogenes* in 2–4% of the raw milk supply, only two additional listeriosis cases have been linked to ingestion of raw milk (Ryser, 1999a).

During the summer of 1983, the status of *L. monocytogenes* as a foodborne pathogen began to change when consumption of one particular brand of pasteurized milk was epidemiologically linked to 42 adult and seven infant cases of listeriosis in Massachusetts (Fleming et al., 1985; Ryser, 1999a). Fourteen patients died, giving a mortality rate of 29%. Inspection of the milk processing facility failed to uncover any evidence of improper pasteurization or postpasteurization contamination. Although the dairy factory received milk from several farms on which veterinarians diagnosed listeriosis in dairy cows during the outbreak, *L. monocytogenes* was never recovered from the incriminated milk, which in turn raises serious questions concerning the role of pasteurized milk in this outbreak. During July of 1994, Dalton et al. (1997) reported that 54 previously healthy individuals developed listeriosis 9–32 h after drinking pasteurized chocolate milk at a picnic in Illinois, with 12 additional cases also documented in Illinois, Wisconsin, and Michigan (Proctor et al., 1995). Unlike the aforementioned outbreaks, gastrointestinal symptoms (diarrhea, fever, chills, nausea, and vomiting) predominated. Additionally, only four victims required short hospitalization, with one pregnant woman delivering a healthy baby 5 days after experiencing a 6-h bout of diarrhea. The epidemic strain of *L. monocytogenes* serotype 1/2b was recovered from unopened containers of chocolate milk at levels of 10^8 – 10^9 CFU/mL, with the product's taste and quality reportedly being poor. This outbreak was attributed to postpasteurization contamination of the milk from the factory environment followed by inadequate and/or nonexistent refrigeration during packaging and transit with probable growth of *Listeria* during this period. Despite numerous product recalls, repeated attempts have generally failed to culturally confirm other nonfermented dairy products, including ice cream and butter, as vehicles of listeric infection.

Ingestion of *Listeria*-contaminated cheese has been more commonly linked to listeriosis, with four major outbreaks, several smaller outbreaks and at least 10 sporadic cases thus far reported. The first and largest of these outbreaks occurred in the Los Angeles area during the first half of 1985 and involved an estimated 300 cases (Ryser 1999a). Consumption of California-made Jalisco-brand Mexican-style cheese contaminated with *L. monocytogenes* serotype 4b

Table 5 Major Listeriosis Outbreaks Involving Milk and Dairy Products

Location	Year	Product	Number of cases	Reference
Halle, former East Germany	1949–1957	Raw milk, sour milk, cream, cottage cheese	Approx. 100	Gray and Killinger (1966) Ryser (1999a)
Massachusetts	1983	Pasteurized milk	49	Fleming et al. (1985) Ryser (1999a)
Los Angeles	1985	Mexican-style cheese	Approx. 300	Linnan et al. (1988) Ryser (1999a)
Vaud, Switzerland	1983–1987	Vacherin Mont d'Or, soft-ripened cheese	122	Bula et al. (1995) Ryser (1999a)
Illinois, Michigan, Wisconsin	1994	Pasteurized chocolate milk	54 ^a	Dalton et al. (1997) Ryser (1999a)
France	1995	Brie cheese	20	Goulet et al. (1995)
France	1997	Pont l'Évêque cheese	20	Ryser (1999a)

^a Gastroenteritis.

was linked to 142 listeriosis cases in Los Angeles County, resulting in 48 deaths (mortality rate of 34%) (Linnan et al., 1988). The contaminated cheese was subsequently recalled nationwide. Factory records suggested that raw milk might have been added to pasteurized milk used in cheese making. Although not isolated from the incoming raw milk supply, the epidemic strain was ubiquitous in the factory environment, which suggests ample opportunity for postpasteurization contamination.

In the second of these outbreaks, consumption of Vacherin Mont d'Or—a soft, surface-ripened, cheese—contaminated with *L. monocytogenes* serotype 4b was linked to 122 listeriosis cases in Switzerland from 1983 to 1987 (Bula et al., 1995; Ryser 1999a). Thirty-four patients died, giving a mortality rate of 28%. Two different epidemic-associated strains of *L. monocytogenes* serotype 4b were isolated from patients, incriminated cheese, and wooden shelves and brushes used in 40 different cheese-ripening cellars. Detection of the epidemic strain at levels of 10^4 – 10^6 cfu/g in surface samples of cheese supported both contamination and growth of *L. monocytogenes* on the cheese during ripening. The outbreak ceased after installation of metal ripening shelves and thorough cleaning and sanitizing of the ripening rooms.

In addition to the aforementioned outbreaks, several smaller outbreaks in France have been linked to surface-ripened cheese (Ryser 1999a). In one of the outbreaks, 20 listeriosis cases were traced to consumption of Brie cheese prepared from raw milk (Goulet et al., 1995). Eleven of these cases occurred in pregnant women with the remaining nine cases involving elderly or immunocompromised adults. Unlike previous outbreaks, no geographical clustering was observed, with cases reported in 8 of 22 French regions. The same epidemic strain was recovered from these patients and the cheese, with this organism likely being present in raw milk used for cheese making. Remaining reports of cheeseborne listeriosis are confined to a series of isolated cases reviewed by Ryser (1999a), only one case of which was well documented and positively linked to consumption of raw goat's milk cheese (McLauchlin et al., 1990).

5. Occurrence and Survival in Dairy Products

Dairy cattle, sheep, and goats can intermittently shed *L. monocytogenes* in their milk at levels up to 10^4 cfu/mL as a result of listeric mastitis, encephalitis, or a *Listeria*-related abortion. Whereas milk from obviously infected cows is unlikely to reach consumers, mildly infected and apparently healthy animals can shed *L. monocytogenes* in their milk for many months and are thus of greater public health concern. Composite results from numerous bulk tank surveys conducted since 1983 indicate that 3.2, 2.3, and 3.8% of all raw milk processed in the United States, Canada, and western Europe, respectively, will likely contain low levels (i.e., < 10 cfu/mL) of *L. monocytogenes* at any given time (Ryser 1999b). How-

ever, *L. monocytogenes* populations in naturally contaminated raw milk can increase 1000-fold after 4 and 10 days of storage at 10° and 4°C, respectively (Farber et al., 1990).

L. monocytogenes is more heat tolerant than most other non-spore-forming pathogens (Doyle et al., 1987). However, current vat and high-temperature, short-time pasteurization practices ensure total destruction of *L. monocytogenes* as long as the raw milk is properly handled and refrigerated at 4°C to minimize growth. Despite the ability of *L. monocytogenes* to attain populations of 10⁶ cfu/mL in skim milk, whole milk, chocolate milk, and whipping cream after 8 days of storage at 8°C (a common temperature of home refrigerators), this organism has been rarely detected in pasteurized fluid milk products (Rosenow and Marth, 1987). Although *L. monocytogenes* has been occasionally recovered from commercially produced butter, with survival up to 70 days also being reported in butter prepared from inoculated cream (Olsen et al., 1988), this pathogen is a far more frequent postpasteurization contaminant of ice cream. Since May 1986, over 54 *Listeria*-related class I recalls were issued for unfermented dairy products, approximately 85% of which involved ice cream, ice cream novelties, and related frozen desserts contaminated with very low levels of *L. monocytogenes* (Ryser, 1999b). Increased prevalence of this pathogen in frozen rather than fluid dairy products coincides with the relatively complex handling of such products, particularly ice cream novelties, during manufacture and packaging. Given presumed low levels of contamination, inability of *Listeria* to grow in frozen dairy products and recall of more than 3 million gallons of ice cream without incident, consumption of such products does not appear to pose a major public health threat.

As can be surmised from the previous discussion of outbreaks, *L. monocytogenes* is a frequent contaminant of cheese, most notably soft, surface-ripened varieties such as Brie and Camembert, which support growth of the organism during cheese ripening. Since 1986, over 35 class I recalls were issued for domestically produced cheese, principally Mexican-style cheese contaminated with *L. monocytogenes* (Ryser, 1999c). During this same period, at least 28 imported cheeses, including French Brie, Danish Esrom, and Anari goat's milk cheese from Cyprus, were similarly recalled. According to Ryser (1999c), approximately 4% of European-produced cheeses, primarily soft and semisoft varieties, can be expected to harbor *L. monocytogenes*.

Considerable work has been done to define the behavior of *L. monocytogenes* during manufacture and storage of yogurt, buttermilk, and a wide variety of cheeses, with most of these studies describing what happens if the product is prepared from artificially contaminated pasteurized milk (Ryser, 1999c). In one of several studies assessing postpasteurization contamination, *L. monocytogenes* persisted an average of 3 weeks in refrigerated cultured buttermilk and yogurt inoculated to contain 10³ and 10⁴ *L. monocytogenes* cfu/g (Choi et al., 1988). *Listeria* populations generally increase as much as 10-fold when milk is fer-

mented using a 1% inoculum of a traditional mesophilic or thermophilic lactic acid bacteria starter culture, with growth ceasing at pH less than or equal to 5.2 (Schaack and Marth, 1988a, 1988b). However, physical entrapment of *Listeria* in curd during cheese making results in a 10-fold increase in numbers. Growth of *Listeria* in cheese is primarily confined to soft and semisoft varieties such as blue, brick, Camembert, and goat cheese, with populations increasing to at least 10^6 cfu/g as the cheese attains a pH greater than 6 during ripening (Table 6). Although generally unable to grow in fermented dairy products having a pH less than 5.5, *L. monocytogenes* can survive in many such cheeses for weeks or months, with this pathogen even being recovered from 434-day old Cheddar cheese (Ryser and Marth, 1987a). These findings raise serious concerns regarding the adequacy of the mandatory 60-day holding period at greater than or equal to 1.7°C for complete inactivation of *L. monocytogenes* (and other pathogens) in Cheddar and certain other hard cheese that can be legally prepared from raw milk. However, barring contamination during packaging, cheeses such as cottage and mozzarella, which undergo severe heat treatments during manufacture, should be *Listeria* free (Buazzi et al., 1992; Ryser et al., 1985).

6. Prevention

Although *L. monocytogenes* is more heat resistant than most other foodborne pathogens, current vat and high-temperature, short-time pasteurization practices inactivate expected levels of *L. monocytogenes* in raw milk. Thus, barring post-pasteurization contamination, pasteurized fluid milk products pose a minimal public health risk. Given the many gallons of ice cream recalled in the United States, low-level contamination in frozen desserts also appears to be of little health concern. However, certain low-acid, soft, and surface-ripened cheeses such as Mexican-style and Brie cheese can support growth of *L. monocytogenes* to dangerous levels during ripening, as evidenced by three major outbreaks of listeriosis involving numerous fatalities. Consequently, individuals at highest risk (i.e., pregnant women, elderly people, and immunocompromised adults) may want to refrain from eating such cheeses.

J. Salmonellosis

Nontyphoid salmonellae were first recognized as foodborne pathogens in the 1880s when acute gastroenteritis developed in 57 people after consuming beef that was contaminated with *Bacterium enteritidis*, which was renamed *Salmonella* Enteritidis in 1900 in honor of the American bacteriologist D. E. Salmon (Marth, 1969). From the turn of the century to about 1940, typhoid fever was commonly associated with consumption of raw milk, as described earlier. However, the gastroenteritic form of nontyphoid salmonellosis (hereafter salmo-

Table 6 Fate of *L. monocytogenes* in Various Cheeses During Ripening and Storage

Cheese	pH		Ripening temp (°C)	<i>L. monocytogenes</i> (log ₁₀ cfu/g or mL)			Survival (Days)	Reference
	Initial	Final		Cheese				
				Milk	Maximum	Final		
Blue	4.6	6.3	9–12/4	3.0	4.0–5.0	1.0–2.3	>120	Papageorgiou and Marth (1989a)
Brick	5.3	7.3	15/10	2.5–3.0	4.6–6.7	2.7–6.1	>168	Ryser and Marth (1988b)
Camembert	4.6	7.5	15/6	2.5–3.0	6.7–7.5	6.7–7.5	>65	Ryser and Marth (1987b)
Cheddar	5.1	5.1	13	2.5–3.0	2.6–3.8	<1.0	70–224	Ryser and Marth (1987a)
Cheddar	5.1	5.1	13	2.5–3.0	3.0–3.7	<1.0–1.5	70–>434	Ryser and Marth (1987a)
Colby	5.1	5.1	4	2.5–3.0	3.6–4.6	2.3–4.1	>140	Yousef and Marth (1988)
Cold-pack	5.3	5.1	4	2.4–2.8	2.4–2.8	1.1–2.0	>180	Ryser and Marth (1988a)
Cottage	5.4	5.2	3	4.0–5.0	1.3–2.8	<1.0–2.4	17–28	Ryser et al. (1985)
Feta	4.7	4.4	22/4	3.7	5.7–6.2	2.8–4.6	>90	Papageorgiou and Marth (1989b)
Goat	5.5	6.2	12	5.0–6.0	6.9	6.2	>126	Tham (1988)
Gouda	5.5	5.5	13	2.5	4.2	3.2	>42	Northolt et al. (1988)
Mozzarella	5.2	5.2	5	4.0–5.0	<10	<10	<1	Buazzi et al. (1992)
Parmesan	5.1	5.1	13	4.0–5.0	3.3–4.3	<10	14–112	Yousef and Marth (1990)

nellosis) was not clearly linked to raw milk consumption until the mid-1940s. Interest in milkborne salmonellosis has peaked twice since the 1940s, first in 1966 when several large outbreaks were traced to nonfat dry milk and again in 1985 when one of the largest recorded outbreaks of foodborne salmonellosis involving more than 180,000 cases was traced to consumption of a particular brand of pasteurized milk in the Chicago area (El-Gazzar and Marth, 1992). Three years before the Chicago outbreak, milk and dairy products were responsible for 5 of 55 (9%) outbreaks of foodborne illness in the United States (MacDonald and Griffin, 1983). Today, *Salmonella* and *Campylobacter* are generally recognized as the two leading causes of dairy-related illness in the United States and western Europe, with rates of infection being particularly high in regions of the world where raw milk is neither pasteurized nor boiled.

1. General Characteristics

All salmonellae are of public health concern given their ability to produce infections ranging from a mild self-limiting form of gastroenteritis associated with consumption of contaminated dairy products to septicemia and life-threatening typhoid fever produced by *S. Typhi*, as discussed previously. A prominent group of the family Enterobacteriaceae, salmonellae are short, gram-negative, facultatively anaerobic, rod-shaped bacteria (El-Gazzar and Marth, 1992; Kantor, 1986). These organisms grow on common laboratory media at temperatures between 5 and 45°C (optimum 35–37°C) and at a_w values greater than or equal to 0.95 (Bryan et al., 1979). However, a few strains can multiply in both laboratory media and certain foods at refrigeration temperatures (Matches and Liston, 1968). Biochemically, salmonellae produce gas from glucose, reduce nitrate to nitrite, and can utilize citrate as a sole carbon source (Flowers et al., 1992). Most strains are lysine decarboxylase positive, hydrogen sulfide positive, and motile by peritrichous flagella, but important exceptions have been noted. Further classification of the genus *Salmonella* is still a source of confusion, because there are three different classification schemes. Using the classic and still popular Kauffmann-White scheme, which is based on somatic (O), flagellar (H), and capsular (Vi) antigens, more than 2300 *Salmonella* serovars (distinct antigenic profiles) are recognized (D'Aoust, 1994). These serovars can be grouped into five different subgenera. In this classification scheme, each serovar has a descriptive and geographical "species" or "popular" name such as *Salmonella* Typhimurium or *Salmonella* Heidelberg, with these names still being widely used. The Edwards and Ewing scheme, another antigenically based classification system currently decreasing in popularity, recognizes three major species or groups—*S. Typhi*, *Salmonella* Choleraesuis, and *S. Enteritidis* with the last species comprising nearly all of the 2300 aforementioned *Salmonella* serovars. Based on DNA hybridization studies, the genus *Salmonella* also can be divided into seven widely

accepted subgroups (Flowers et al., 1992), each with its own phenotypic characteristics.

2. Isolation and Detection Methods

Examination of dairy products for *Salmonella* (Andrews et al., 1998; Flowers et al., 1992a, 1992b) begins with preenrichment of the sample in a nonselective medium, most often lactose broth, for resuscitation of injured or debilitated cells. Following 18–24 h of incubation at 35°C, two different selective enrichment media—selenite cystine and tetrathionate broth—are inoculated from the preenrichment broth and similarly incubated. Thereafter, plates of Hektoen enteric, xylose lysine desoxycholate, and bismuth sulfite agar are streaked from both selective enrichment broths and incubated 24–48 h at 35°C for selective isolation of salmonellae. Alternatively, several rapid methods using fluorescent antibodies, hydrophobic grid membrane filtration, enzyme immunoassays, DNA hybridization, immunodiffusion, and conductivity are commercially available for detecting salmonellae in enriched samples. All positive findings must be culturally confirmed. Presumptive isolates are confirmed as *Salmonella* using a standard series of 16 biochemical tests in combination with serological screening tests that use polyvalent O antisera and either polyvalent H or Spicer-Edwards antisera. Five commercially available biochemical test kits (i.e., API 20E, Enterotube II, Enterobacteriaceae II, MICRO-ID, and Vitek GNI) are approved alternatives to traditional biochemical confirmation. Biochemically presumptive salmonellae must still be subjected to serological confirmation with complete serotyping of epidemiologically important strains confined to qualified reference laboratories.

3. Clinical Manifestations

Although commonly referred to as *Salmonella* “food poisoning,” gastroenteritis—the first of three clinical manifestations produced by nontyphoid salmonellae—is an infection (not an intoxication or “poisoning”) of the small intestine and less commonly the colon, with no involvement of preformed toxins (D’Aoust, 1994; El-Gazzar and Marth, 1992; Kantor, 1986). The first symptoms to appear after an initial incubation period of 12–36 h include nausea and vomiting, both of which subside within a few hours. Development of mild fever, chills, and abdominal pain sometimes resembling acute appendicitis is soon followed by diarrhea, the most prominent symptom, which can range from a few loose stools to overtly bloody and rice water cholera-like stools in more severe cases. During this period, all infected individuals excrete *Salmonella* in their feces with samples from acute cases often containing 10^6 – 10^9 salmonellae/g. Although this self-limiting illness typically subsides within 5 days without intervention, symptoms can persist up to several weeks with 10% of fully recovered patients excreting salmonellae for at least 2 months.

Septicemia, the second manifestation of salmonellosis (D'Aoust, 1994; El-Gazzar and Marth, 1992; Kantor, 1986), occurs as a complication of gastroenteritis in less than 4% of adult patients with fever being the primary symptom. Even though salmonellosis is generally considered to be among the less serious types of blood infections, fatalities have been reported in 13% of individuals with serious underlying illnesses such as cancer and liver disease.

Localized tissue infections, the third manifestation of salmonellosis (D'Aoust, 1994; El-Gazzar and Marth, 1992; Kantor, 1986), occur as a complication in 8–25% of patients with prolonged or untreated septicemic infections. Although any part of the body may become infected, lesions and abscesses are most frequently associated with previously damaged or diseased organs and tissues. Infections most commonly include osteomyelitis, meningitis, and pneumonia followed by pyelonephritis, endocarditis, and suppurative arthritis.

Salmonellosis can only be clinically confirmed by isolating salmonellae from stool, blood, or other specimens. Because this disease is most often mild and self-limiting, treatment is usually aimed at preventing dehydration through fluid replacement (Kantor, 1986). As in other types of gastroenteritis, administration of antibiotics is contraindicated and limited to patients who either have septicemic or localized tissue infections or are at high risk of development of such complications. When necessary, the drug of choice is chloramphenicol given only intravenously.

4. Outbreaks

Dairy-related outbreaks of nontyphoid salmonellosis were first recognized in the 1940s, with raw milk being most commonly identified as the source of infection. At least four notable outbreaks involving raw milk consumption occurred in the United States since 1967, with *S. Typhimurium* and *S. Dublin* identified as the causative serovars (Table 7). Although certified raw milk legally sold in California was responsible for one of these outbreaks involving *S. Dublin*, similar outbreaks have been documented as far back as 1958 (Anonymous, 1981). Findings from one epidemiological case-control study (Richwald et al., 1988) suggest that one-third of all *S. Dublin* infections in California are raw milk related, with the incidence of infection being highest among immunocompromised adults.

In England and Wales where records are more complete, raw milk consumption was responsible for 132 of 148 predominantly small, dairy-related outbreaks (2369 of 2466 cases) from 1951 to 1980 (Galbraith et al., 1982). As in the United States, the predominant *Salmonella* serovars again included *S. Typhimurium* (88 outbreaks) and *S. Dublin* (14 outbreaks), both of which are frequently recovered from raw milk, dairy cattle, and farm environments (Marth, 1969). During the 1980s, raw milk consumption was linked to at least 58 outbreaks involving 1088 cases in England and Wales, with the size of these outbreaks

Table 7 Major Salmonellosis Outbreaks Associated with Milk and Milk Products from 1965 to 1994

Location	Year	Product	<i>Salmonella</i> Serovar	Number of cases	Reference
United States					
Nationwide	1965–1966	Nonfat dry milk	Newbrunswick	29	Collins et al. (1968)
New York	1967	Ice cream	Typhimurium	1790	Armstrong et al. (1970)
Washington	1967	Raw milk	Typhimurium	40	Francis and Allard (1967)
California	1971–1975	Raw milk	Dublin	44	Werner et al. (1979)
Maine	1973	Eggnog	Typhimurium	32	Steere et al. (1975)
Louisiana	1975	Pasteurized milk	Newport	43	Blouse et al. (1975)
Colorado	1976	Cheddar	Heidelberg	339	Fontaine et al. (1980)
Arizona	1978	Pasteurized milk	Typhimurium	23	Dominguez et al. (1979)
Washington	1980–1981	Raw milk	Dublin	125	Nolan et al. (1981)
Montana	1981	Raw milk	Typhimurium	59	Day et al. (1981)
Kentucky	1984	Pasteurized milk	Typhimurium	16	Adams et al. (1984)
Illinois	1985	Pasteurized milk	Typhimurium	16,000	Ryan et al. (1987)
Nationwide	1989	Mozzarella	Javiana/Oranienburg	164	Hedberg et al. (1992)
Kansas	1992	Ice cream	Enteritidis	15	Anonymous (1992a)
Kansas	1992	Ice cream	Enteritidis	31	Anonymous (1992a)
Florida	1993	Ice cream	Enteritidis	14	Buckner et al. (1994)

Nationwide	1994	Ice cream	Enteritidis	224,000	Anonymous (1994), Hennessy et al. (1996)
Washington	1997	Mexican-style cheese	Typhimurium DT104	17	
Canada					
Ontario	1980–1983	Cheddar	Muenster	33	Styliadis and Barnum (1984)
5 Provinces	1984	Cheddar	Typhimurium	2,000	Bezanson et al. (1985)
Ontario	1994	Raw milk soft cheese	Berta	82	Ellis et al. (1998)
Europe					
England	1972–1973	Raw milk	Typhimurium	316	MacLachlan (1974)
Scotland	1976	Raw milk	Dublin	700	Small and Sharp (1979)
England	1977	Raw milk	Typhimurium	334	Anonymous (1977)
Poland	1978	Pasteurized milk	Enteritidis	890	Suchowiak and Haiat (1980)
Scotland	1981	Raw milk	Typhimurium	654	Cohen et al. (1993)
Poland	1981	Ice cream	Typhimurium	881	Polewska-Jeske et al. (1984)
Italy	1981	Mozzarella	Typhimurium	100	Felip and Toti (1984)
Sweden	1985	Pasteurized milk	Saintpaul	153	Anderson et al. (1986)
Switzerland	1985	Vacherin Mont d'Or	Typhimurium	40	Sharp (1987)
England/Wales	1989	Irish soft cheese	Dublin	42	Maguire et al. (1992)
France	1993	Goat's milk cheese	Enterica	273	Desenclos et al. (1996)

increasing because of commercial distribution of raw milk (Barrett, 1986, 1989; Sockett, 1991). This problem is particularly evident in Scotland where 21 outbreaks (1090 cases) were reported between 1980 and 1982 (Reilly et al., 1983). One of these outbreaks sickened 654 people and cost an estimated \$120,000 (Cohen et al., 1983).

American interest in milkborne salmonellosis first peaked in 1966 when 29 cases of gastroenteritis diagnosed in 17 states over a 10-month period were linked to nonfat dry milk containing *S. Newbrunswick*, a serovar rarely encountered in the United States (Collins et al., 1968). Of the 29 victims, more than half were infants or children younger than 5 years of age. The contaminated product was recalled from sale and soon traced to a single midwest factory producing approximately 11 million lb of nonfat dry milk annually (Marth, 1969). Although the source of contamination was never identified, incomplete pasteurization before spray drying was suspected as one likely cause, with post-processing contamination cited as a contributing factor. Two additional noteworthy outbreaks also have been traced to nonfat dry milk produced in other countries. During 1973, more than 3000 cases of gastroenteritis on the island of Trinidad occurred primarily among infants and young children and were traced to consumption of nonfat dry milk contaminated with *S. Derby* (Weissman et al., 1977). Although faulty packaging equipment may have contributed to this outbreak, the source of contamination was never identified. During 1985, consumption of one particular brand of an infant dried milk product was also responsible for at least 46 cases of *S. Ealing* gastroenteritis in England; the source of infection was traced to a malfunctioning spray dryer (Rowe et al., 1987).

Pasteurized milk can also serve as a vehicle for salmonellosis. Three small pre-1985 outbreaks were linked to ingestion of inadequately pasteurized milk in Louisiana, Arizona, and Kentucky. Such outbreaks did not attract widespread attention until 1985 when more than 16,000 culture-confirmed cases of *Salmonella* gastroenteritis in the Chicago area were traced to consumption of 2% pasteurized milk contaminated with a rare multi-antibiotic-resistant, plasmid-containing strain of *S. Typhimurium* (Ryan et al., 1987; Schuman et al., 1989). One follow-up survey placed the number of people affected at nearly 200,000, making this the second largest outbreak of foodborne salmonellosis ever recorded. (The largest outbreak occurred in 1994, involving approximately 240,000 persons, and was associated with nationally distributed ice cream made in Minnesota [Hennessey et al., 1996]). Although the milk outbreak affected an estimated 3 of every 1000 residents in the Chicago area, with the highest attack rate being observed in children, illness was particularly common among individuals who were taking antibiotics to which this particular strain of *S. Typhimurium* was resistant, with 2500 such hospitalized cases being reported. Further complications developed in 16 of these patients, including osteomyelitis, brain abscesses, and meningitis, or

they had unnecessary appendectomies. Eighteen fatalities were reported with the epidemic strain cited as either the primary or contributing cause of death. The implicated milk containing the epidemic strain was traced to a northern Illinois dairy processing facility and was immediately recalled from the market. Microbiological studies indicated that the outbreak-related strain was heat sensitive and would not be expected to survive pasteurization, but inspection of the dairy plant revealed a potential cross connection between several holding tanks that would have allowed raw milk to contaminate pasteurized skim milk, condensed milk, and cream. The factory ceased operations when the outbreak occurred and has not reopened.

During 1992 and 1993, homemade ice cream was linked to three small outbreaks of *S. Enteritidis* gastroenteritis in Florida and Kansas, with a similar family outbreak also recently reported in England (Morgan et al., 1994a). The source of contamination in all of these outbreaks was traced to raw eggs, an ingredient of homemade ice cream particularly noted for harboring *S. Enteritidis*. One year later, commercially produced ice cream was responsible for 2000 (final estimate 240,000 cases) cases of *S. Enteritidis* gastroenteritis in Minnesota, Wisconsin, South Dakota, and elsewhere with the tainted product eventually recalled nationwide. The ice cream contained less than one organism per gram with an estimated infectious dose of no more than 28 cells in a single serving (Vought and Tatini, 1998). Tankers used to haul liquid raw eggs also were used to haul pasteurized ice cream mix to the ice cream factory where the mix was not repasteurized. The tankers were the likely source of *S. Enteritidis* (Hennessy et al., 1996).

Salmonellosis outbreaks involving fermented dairy products have been primarily confined to cheese, with six notable outbreaks being reported since 1976. In the first of these outbreaks, 339 cases of *S. Heidelberg* gastroenteritis were identified in Colorado and traced to Cheddar cheese prepared in Kansas from pasteurized milk (Fontaine et al., 1980). The incriminated cheese contained less than one organism per 100 g, thus suggesting a low oral infectious dose, with prompt recall of the product possibly averting up to 25,000 additional cases. Cheddar cheese was again identified as the vehicle of infection in two Canadian outbreaks reported during the 1980s. In the first outbreak, *S. Muenster* was recovered from aged raw milk Cheddar cheese and was traced to an infected dairy herd with one mastitic cow shedding 2000 *S. Muenster*/per mL of milk. Few serovars other than *S. Muenster* and *S. Dublin* can reportedly infect the bovine mammary gland and contaminate milk in this manner. The second and largest cheeseborne salmonellosis outbreak occurred in Ontario and the four maritime provinces with more than 2000 culture-confirmed cases in 1984 linked to Cheddar cheese prepared from heat-treated or pasteurized milk (Bezanson et al., 1985; D'Aoust et al., 1985; Ratnam and March, 1986). Two distinct strains of *S. Typhi-*

murium were implicated in this outbreak. Both strains were recovered from cheese at levels of less than 10 organisms per 100 g, which again suggests a low oral infectious dose.

Seven outbreaks have been traced to cheeses other than Cheddar, with one of these outbreaks responsible for 164 cases of salmonellosis in Minnesota, Wisconsin, Michigan, and New York during 1989. Mozzarella cheese containing two epidemic strains, *S. Javiana* and *S. Oranienburg*, was the vehicle of infection. Inadequate factory sanitation practices and contamination of the cheese by infected production workers were suggested as probable causes. Another North American outbreak in Ontario was linked to farmstead soft cheese with *S. Berta* isolated from chickens on the farm (Ellis et al., 1998). During the first half of 1997, at least 17 cases of salmonellosis in Washington state were epidemiologically linked to Mexican-style cheese prepared from raw milk (Villar et al., 1999). Unlike previous outbreaks, this cheese, which was consumed primarily by Hispanic children, contained *S. Typhimurium* DT104—a rapidly emerging multi-antibiotic-resistant strain that currently comprises about one-tenth of all *S. Typhimurium* isolates examined at the Centers for Disease Control and Prevention. This strain of *Salmonella* was eventually traced to several nearby dairy herds. The four remaining cheese-associated outbreaks occurred in Europe, one of which involved a soft raw milk Irish-type cheese prepared on a family farm in England. Contamination was traced to four family-owned cows that were asymptotically excreting *S. Dublin*, the epidemic strain in this outbreak. The remaining milkborne cases of salmonellosis have almost invariably involved milk from dairy cows, with a few small outbreaks and two large outbreaks outside the United States being linked to goat's milk (Sharp, 1987) and goat's milk cheese (Desenclos et al., 1996).

5. Occurrence and Survival in Dairy Products

Numerous *Salmonella* infections have been reported in dairy cattle and other ruminant animals with symptomatic and asymptomatic shedding of the organism in feces (Marth, 1969; Styliades and Barnum, 1984). Although salmonellae are seldom associated with mastitis, *S. Dublin* and *S. Muenster* can colonize the udder and be shed in milk at levels up to 2000 organisms/mL (Fontaine et al., 1980). According to McManus and Lanier (1987), raw milk is a good source of salmonellae, with 32 of 678 (4.7%) raw milk bulk tank samples testing positive in Wisconsin, Michigan, and Illinois. Five years later, Rohrbach et al. (1992) identified *Salmonella* in 26 of 292 (8.9%) farm bulk tank samples collected from eastern Tennessee and southwest Virginia. However, lower contamination rates have been reported elsewhere. Following the 1980 to 1983 cheeseborne outbreak in Ontario, Canada, McEwen et al. (1988) detected salmonellae, including *S. Muenster* (the epidemic serovar), in raw milk bulk tanks from 9 of 759 (1.2%) dairy

farms participating in this year-long study, with most positive samples being observed during autumn. More recently, milk from only 3 of 1720 (0.17%) farm bulk tanks in Ontario tested positive for *Salmonella* (Steele et al., 1997). In England, 2 of 1138 (0.2%) raw milk samples on sale to the public harbored salmonellae (Humphrey and Hart, 1988), thereby reaffirming the potential hazard of raw milk consumption.

Standard vat and high-temperature, short-time pasteurization destroys expected levels of salmonellae (i.e., <100 cfu/mL), including *S. Senftenberg* 775W (the most heat-resistant serovar) with a wide margin of safety (D'Aoust et al., 1987). Inadequate pasteurization and postprocessing contamination have occasionally resulted in milk and cream that tested positive for *Salmonella* as evidenced from the aforementioned outbreaks. Unlike *Listeria* and *Yersinia*, which can grow during refrigeration, numbers of salmonellae decrease in fluid milk products and butter prepared from inoculated cream during extended storage at less than or equal to 7°C (Kasrazadeh and Genigeorgis, 1994; Sims et al., 1970; Wundt and Schnittenhelm, 1965). However, at 12 and 20°C, *Salmonella* populations double every 20 and 8.8 h, respectively, which reinforces the need for constant refrigeration.

Nonfat dried milk also can occasionally harbor salmonellae as demonstrated by a highly publicized 1966 outbreak in the United States. Surveys conducted on nonfat dried milk over the following 2 years showed that 0.2% of all samples contained salmonellae (Marth, 1969), and another study (Licari and Potter, 1970a) showed that commercial spray drying conditions killed more than 99.9% of salmonellae in inoculated skim milk but did not yield *Salmonella*-free nonfat dry milk at the inoculum levels used. In a follow-up study (Licari and Potter, 1970b), *Salmonella* populations in heavily inoculated nonfat dried milk decreased sharply when the product was held at 25°C to 55°C. However, persistence of salmonellae in some samples for at least 8 weeks indicates that such storage cannot be used as a substitute for good manufacturing practices.

Ice cream and related frozen desserts can become contaminated before freezing and give rise to outbreaks of salmonellosis. Except for the aforementioned 1994 outbreak involving approximately 240,000 cases in the United States, such contamination has been primarily confined to homemade ice cream with raw eggs being the invariable source of *S. Enteritidis*. Contamination rates are very low in commercially produced ice cream, with two recent European surveys identifying salmonellae in 0 of 157 (Massa et al., 1989) and 1 of 67 (Rodriguez-Alvarez et al., 1994) samples sold in Italy and Spain, respectively. However, higher *Salmonella* contamination rates have been reported in less developed countries such as Iraq (Al-Rajab et al., 1986) where 12 of 110 (10.9%) locally produced ice cream samples tested positive.

Despite the recent cheese-related salmonellosis outbreaks, salmonellae are rarely isolated from commercially produced cheeses including Cheddar. In sur-

veys responding to the 1980–1983 outbreak in Ontario, Canada, Brodsky (1984a, 1984b) failed to recover *Salmonella* from 250 samples of freshly prepared Cheddar cheese or 127 samples of 60-day-old Cheddar cheese prepared from raw milk. According to Mor-Mur et al. (1992), 42 samples of 60-day-old farm-produced goat's cheese in Spain were also free of salmonellae. However, presence of salmonellae in 8 of 142 (5.6%) locally produced Iranian cheeses (Farkhondeh et al., 1974) again raises concerns regarding safety of dairy products manufactured in less developed countries where salmonellosis is endemic.

The fate of salmonellae has been assessed during the manufacture and ripening of many different cheeses (Table 8). Modest growth of salmonellae occurs during Cheddar cheese making, as predicted by Park and Marth (1972a), with populations increasing 10- to 100-fold beyond the expected 10-fold increase, which results from physical entrapment of the organism during curd formation. Furthermore, when cheeses from the same lot were ripened at 0–13°C, salmonellae survived 84–300 days, with the pathogen always persisting longer in cheese ripened at the lower temperature. White and Custer (1976) subsequently reported that 16 of 48 (33%) and 6 of 48 (12.5%) lots of Cheddar cheese similarly prepared from milk containing 10^5 salmonellae cfu/mL were still positive after 9 months of ripening at 4.5 and 10°C, respectively. Most important, when naturally contaminated Cheddar cheese from the two Canadian outbreaks was stored at 5°C, salmonellae persisted up to 125 days (Styliades and Barnum, 1984; Wood et al., 1984) and 240 days (D'Aoust, 1985), well beyond the required 60-day holding period at greater than or equal to 1.7°C for such cheeses prepared from raw or heat-treated milk. Using Cheddar cheese samples from the outbreak, D'Aoust (1985) estimated the oral infective dose at one to six total cells of *Salmonella*, which suggests that even very low levels of contamination can pose serious health risks.

Additional cheese varieties studied have included mozzarella following the 1985 outbreak in the United States as well as cottage and Brie cheeses. According to Eckner et al. (1990), *Salmonella* was completely inactivated during molding and stretching of mozzarella cheese curd at 60°C. However, contamination of mozzarella cheese during shredding or packaging can lead to extended survival of salmonellae and possible health risks as evidenced from the aforementioned outbreak. Cottage cheese would appear to be of minimal public health concern, with large populations of salmonellae completely inactivated after cooking the curd and whey mixture at 125°F (52°C) for 20 min (McDonough et al., 1967). However, salmonellae also can persist in cottage cheese as postpasteurization contaminants throughout the normal shelf life of the product (Sims et al., 1989). Soft surface-ripened cheeses such as Brie and Vacherin Mont d'Or have been implicated in major outbreaks involving other pathogenic organisms, including *E. coli* and *L. monocytogenes*, which can attain high levels on the surface of these cheeses during ripening. Although growth of salmonellae on the surface of such cheeses is prevented during ripening at 4–20°C (Little and Knochel,

Table 8 Fate of Salmonellae in Various Cheeses During Ripening and Storage

Cheese	Salmonella (log 10 cfu/g or ml)						Survival (Days)	Reference
	pH		Ripening temp (°C)	Cheese				
	Initial	Final		Milk	Maximum	Final		
Cheddar	5.52	5.22	0	3.14	5.78	1.00	180	Hargrove et al. (1969)
Cheddar	5.52	5.15	4	3.14	5.78	0.30	150	Hargrove et al. (1969)
Cheddar	5.70	5.40	7	2.00	4.10	1.30	210	Park et al. (1970a)
Cheddar	5.80	5.60	13	2.00	5.30	1.00	>210	Park et al. (1970a)
Cheddar	5.10	—	7.5	1.90	5.00	<1.00	112	Goepfert et al. (1968)
Cheddar	5.10	—	13	1.90	5.00	<1.00	84	Goepfert et al. (1968)
Mozzarella	—	—	—	6.00	6.00	<1.00	<1	Eckner et al. (1990)
Monterey Jack	—	—	4.5	6.50	9.00	4.50	>183	Eckner and Zottola (1991)
Montasio	5.30	5.60	12	6.80	5.80	0.80	90	Stecchini et al. (1991)
Feta (pasteurized cow's milk)	5.10	5.69	4	3.40	6.20	1.90	>75	Erkmen and Bozoglu (1995)
Feta (raw ewe's milk)	4.80	4.40	4	7.30	8.90	1.00	20	Papadopoulou et al. (1993)
Cold-pack	5.10	4.70	12.8	—	2.70	1.00	>188	Park et al. (1970b)
Cold-pack	5.10	5.05	4.4	—	2.70	1.70	>188	Park et al. (1970b)

1994), continued survival of the organism during ripening may again pose a potential health hazard.

6. Prevention

Historically, salmonellosis has been most commonly traced to raw milk, and consumption of such milk is best avoided. Despite several outbreaks and reports of extended survival of salmonellae in cheese, most cheeses—including those legally prepared from raw or heat-treated milk and then properly aged—appear to pose a minimal health risk. All salmonellae are readily destroyed by pasteurization. Hence, if postpasteurization contamination is prevented, all pasteurized dairy products will be free of salmonellae. However, use of raw eggs (a potential source of *S. Enteritidis*) in homemade ice cream is strongly discouraged as evidenced from a series of recent outbreaks.

K. Staphylococcal Poisoning

A classic foodborne intoxication, staphylococcal poisoning results from ingesting a preformed, heat-stable toxin (termed enterotoxin) produced by the bacterium *Staphylococcus aureus*. Although reports of cases resembling present-day staphylococcal poisoning date back to 1830, the organism was not observed microscopically until the 1870s (Bergdoll, 1979). Ogston coined the term *staphylococcus* (from the Greek words *staphyle*, bunch of grapes, and *coccus*, a grain or berry) to describe this organism in 1881, with Rosenbach proposing the genus *Staphylococcus* and the species *S. aureus* 3 years later. Known during the 1870s to cause skin infections, staphylococci were not associated with foodborne illness until 1884 when Vaughan and Sternberg recovered the organism from Cheddar cheese linked to approximately 300 cases of food poisoning in Michigan (Hendricks et al., 1959). In 1914, the relationship between staphylococcal food poisoning and the toxin produced by *S. aureus* was established by Barber using human volunteers during a milkborne outbreak in the Phillipines. These findings were later confirmed by Dack et al. (1930) using sterile culture filtrates, with the first of 10 known enterotoxins being purified during the late 1950s (Bergdoll et al., 1959).

Dairy products are well-known vehicles of staphylococcal poisoning, with cheese and raw milk being linked to outbreaks before the turn of the last century (Bergdoll, 1979). Following a marked decrease in incidence of milkborne typhoid and scarlet fever, staphylococcal poisoning emerged as the major milkborne illness by the late 1930s, accounting for 26, 50, and 30% of all milkborne diseases reported in the United States during the 1940s, 1950s, and 1960s, respectively (Bryan, 1983). These cases of staphylococcal poisoning involved various dairy products including raw milk, pasteurized milk, cheese, ice cream, butter, and nonfat dry milk. Staphylococcal poisoning has been most commonly traced to

nondairy foods (e.g., ham, cream-filled pastries), with improvements in milk pasteurization and dairy sanitation standards now making dairy-related outbreaks rare in the United States (Headrick et al., 1996), England (Galbraith et al., 1982) and most other industrialized countries.

1. General Characteristics

In the family Micrococcaceae, the genus *Staphylococcus* includes 32 species of facultatively anaerobic, nonmotile, small gram-positive cocci, most of which are catalase positive and oxidase negative (Kloos and Bannerman, 1995; Kloos and Schleifer, 1986). When viewed microscopically, the staphylococci appear in pairs, short chains, tetrads, and grape-like clusters, with the latter arrangement being most evident in cultures grown on solid media. Although 15 *Staphylococcus* spp. are of varying clinical importance in humans, *S. aureus* clearly dominates as the primary human pathogen, being responsible for a wide range of cutaneous and life-threatening systemic infections in addition to toxic shock syndrome and staphylococcal food poisoning.

On nonselective media more than 90% of *S. aureus* (*aureus*: Latin for golden) strains produce pigmented colonies ranging from cream yellow to orange (Kloos and Bannerman, 1995; Kloos and Schleifer, 1986). All isolates grow in common laboratory media at 10–45°C (optimum: 30–37°C) and at pH 4.2–9.3 (optimum: pH 7.0–7.5). Although a few strains can grow at temperatures as low as 6.7°C (Angelotti et al., 1961), production of enterotoxin is typically limited to temperatures above 15°C and pH values above 5. *S. aureus* growth and toxin production are generally poor in the presence of competing microflora. Unlike most other foodborne pathogens, *S. aureus* grows at a_w 0.84 (Lee et al., 1981) and in the presence of up to 15% NaCl (Bergdoll, 1989), with enterotoxin produced at a_w values greater than 0.86. Production of several key enzymes, including coagulase, thermonuclease, and β -hemolysin, is used almost universally to differentiate *S. aureus* from other staphylococci, with sensitivity to lysostaphin and anaerobic utilization of glucose and mannitol also being helpful. However, attempts to associate enterotoxin production in *S. aureus* with specific biochemical properties and phage types have generally failed. Consequently, confirmation of the toxin by serological or other means provides the only proof that the particular strain is enterotoxigenic.

Ten serologically distinct, enterotoxigenic proteins known as enterotoxin types A, B, C₁, C₂, C₃, D, E, F, G, and H are recognized in *S. aureus* (Bergdoll, 1989; Pereira et al., 1996; Su and Wong, 1995), with some strains producing two or three types of enterotoxin (Lopes et al., 1993). Classified as relatively low molecular weight, single-chain polypeptides, these plasmid or chromosomally linked extracellular enterotoxins are resistant to most proteolytic enzymes and a pH of 2, which allows their passage into the gastrointestinal tract without loss

of activity. Although *S. aureus* is readily destroyed in milk during pasteurization, the staphylococcal enterotoxins are relatively heat stable and are not easily inactivated in foods during cooking. Enterotoxin production is not limited to *S. aureus*, with 10 coagulase-negative and 2 coagulase-positive species of staphylococci (*S. hyicus* and *S. intermedius*) also being known to contain enterotoxigenic strains (Bergdoll, 1989). However, other than one recent butter-related outbreak traced to an enterotoxigenic strain of *S. intermedius*, all remaining reports of staphylococcal food poisoning have been confined to *S. aureus* (Khambaty et al., 1994).

2. Isolation and Detection Methods

The significance of finding *S. aureus* in foods suspected of causing staphylococcal poisoning should be interpreted with caution. Although foods must typically contain at least 10^6 enterotoxigenic *S. aureus* cfu/g to induce illness, small numbers of *S. aureus* present in thermally processed foods may represent the survivors of very large populations. Consequently, staphylococcal poisoning can only be verified by isolating enterotoxigenic staphylococci from the food or demonstrating the presence of enterotoxin in the food.

In dairy-related outbreaks of staphylococcal poisoning, samples are normally surface plated on Baird-Parker agar (BPA) (Bennett and Lancette, 1998; Flowers et al., 1992a; Lancette and Tatini, 1992). Following 48 h of incubation at 35°C, presumptive *S. aureus* colonies appear gray to black from reduction of tellurite, with lipolytic strains surrounded by an opaque halo from hydrolysis of egg yolk. A three-tube most probable number method using trypticase soy broth containing 10% NaCl is recommended for samples likely to contain either low numbers of *S. aureus* or high levels of competing background flora. After 48 h of incubation at 35°C, tubes showing growth are streaked to plates of BPA, which are incubated and examined as just described. Presumptive *S. aureus* isolates on BPA are then tested for coagulase activity using either the standard rabbit plasma test or a rapid latex agglutination assay kit. Coagulase-positive strains should be confirmed as *S. aureus* based on results from one of the commercially available rapid test kits or a series of standard biochemical tests, which includes catalase and thermonuclease production, sensitivity to lysostaphin, and anaerobic utilization of glucose and mannitol. Because multiple enterotoxigenic strains of *S. aureus* are frequently encountered in foods, specialized strain-specific typing techniques such as phage typing, plasmid analysis, antibiotic susceptibility pattern, restriction enzyme analysis, and pulsed-field gel electrophoresis are often necessary to clearly identify the source of intoxication (Khambaty et al., 1994).

Identifying enterotoxigenic strains of *S. aureus* in foods has traditionally involved use of specific monoclonal or polyclonal antibodies, which react with antigenically distinct antigens. Isolates are specially cultured for enterotoxin production using either the membrane-over agar, sac culture, or semisolid agar method,

the last of which is AOAC approved and recommended by the FDA (Bennett and Lancette, 1998; Flowers et al., 1992a; Lancette and Tatini, 1992). Two traditional serological methods, namely, the AOAC-approved microslide method (the standard method) and the optimum sensitivity plate, can be used to detect enterotoxin. However, several highly sensitive and rapid methods including latex agglutination, enzyme-linked immunosorbent assays, and DNA hybridization assays are also commercially available for identifying enterotoxins in culture fluids.

Detecting enterotoxin in suspect foods is complicated by the minute amounts of toxin that may be present (Bennett and Lancette, 1998; Flowers et al., 1992a; Lancette and Tatini, 1992). If the standard microslide method is to be used, the toxin must first be extracted from 100 g of food and then concentrated to 0.2 mL in a long and complicated procedure. However, use of the aforementioned rapid assays, which possess greater enterotoxin sensitivity, greatly shortens and simplifies sample preparation.

3. Clinical Manifestations

Staphylococcal food poisoning is a severe foodborne intoxication of short duration. Symptoms normally develop 1–6 h after ingestion of food containing enterotoxin, with nausea, vomiting, diarrhea, abdominal cramps, and mild leg cramps occurring most commonly (Bergdoll, 1989). During the acute stage of illness, individuals may also experience brief headaches, cold sweats, rapid pulse, slight fluctuations in body temperature, and various degrees of prostration and dehydration, all of which depend on sensitivity of the individual and amount of toxin ingested. Early studies with human volunteers and results from a recent outbreak involving chocolate milk have both confirmed that ingesting as little as 1×10^{-7} g of enterotoxin is sufficient to induce aforementioned symptoms in susceptible individuals (Evenson et al., 1988). Acute symptoms typically last only 1–8 h, with the patient fully recovering within 1–2 days. Consequently, most outbreaks are never reported or investigated. Hospitalization is seldom required. However, intravenous therapy and fluid replacement may be necessary in severe cases of dehydration and collapse. Complications from staphylococcal poisoning are seldom encountered and are limited to a few reports of acute gastritis and pseudo-membranous enterocolitis. Although highly unusual, several fatalities have been recorded in the early literature.

4. Outbreaks

Milk and dairy products have been associated with staphylococcal poisoning in the United States for more than 100 years, with numerous accounts of illness documented before 1950. According to Stone (1943), at least 23 outbreaks of staphylococcal poisoning (≥ 1332 cases) were traced to dairy products during the 28-year period from 1914 to 1942. Raw milk was most frequently implicated (7

outbreaks/500 cases) followed by ice cream (5 outbreaks/360 cases), hollandaise sauce (5 outbreaks/90 cases), butter (2 outbreaks/150 cases), evaporated milk (1 outbreak/90 cases), pasteurized milk (1 outbreak/29 cases), and Jack cheese (1 outbreak/5 cases). Such epidemics were particularly common during the 1940s when staphylococcal poisoning was responsible for 22 of 49 (44.9%) milkborne outbreaks reported during 1945, 1946, and 1947. Although staphylococcal poisoning is not generally considered a fatal illness, several deaths did occur among individuals who had consumed raw goat's milk (Weed et al., 1943) and butter (Fanning, 1935). Most of the raw milk outbreaks were traced to staphylococcal mastitis in dairy cows, with temperature abuse of milk cited as a contributing factor (Stone, 1943). Postpasteurization contamination, poor product handling, and transmission by human carriers were most often responsible for outbreaks involving ice cream (Geiger et al., 1935), butter (Stone, 1943), and pasteurized milk (Caudil and Meyer, 1943; Hackler, 1939).

Cheese and nonfat dry milk emerged as major vehicles for staphylococcal poisoning after World War II. According to Hendricks et al. (1959), 18 outbreaks involving at least 475 cases of illness were traced to cheese from 1944 to 1958. The three largest outbreaks were linked to Cheddar cheese (200 cases), cheese sauce (80 cases), and Colby cheese (60 cases) (Allen and Stovall, 1960). In the latter two outbreaks, the cheese was prepared from raw milk containing *S. aureus* and the identical phage type was identified in raw milk from dairy herds supplying the cheese factory. According to Bryan (1983), nonfat dry milk caused 27 outbreaks of staphylococcal poisoning in 1956; 19 of these outbreaks affected 775 school children in Puerto Rico (Armijo et al., 1957). Although the incriminated milk was free of *S. aureus*, toxin was demonstrated using human volunteers, thereby suggesting that the organism grew and produced enterotoxin in the milk before spray drying.

During the 1960s, staphylococcal poisoning accounted for 30% of all dairy-related illnesses in the United States (Bryan, 1983; Woodward et al., 1970). The largest documented outbreak during this period involved 42 cases and was traced to Cheddar and Monterey cheese prepared with a contaminated starter culture (D'Aoust, 1989; Zehren and Zehren, 1968a, 1968b). Using the aforementioned microslide method, which was developed in response to this outbreak, cheese from 59 of 2112 vats was shown to contain an average of 12 μ g of enterotoxin A/100 g.

Given increased monitoring programs for mastitis in dairy cattle coupled with routine milk pasteurization and heightened attention to dairy sanitation, enterotoxigenic staphylococci are now responsible for no more than 5% of all milkborne disease outbreaks (Bryan, 1983; Holmberg and Blake, 1984), with only four major outbreaks reported in the United States since 1970. Even though it is an unusual vehicle for any foodborne illness because of the small amounts typically consumed, butter products were responsible for three of these outbreaks (Table 9), with an enterotoxigenic strain of *S. intermedius* identified as the caus-

Table 9 Outbreaks of Dairy-Related Staphylococcal Poisoning Reported Worldwide Since 1970

Location	Year	Product	Number of cases	Toxin type	Reference
United States					
Alabama	1970	Whipped butter	>26	A	Wolf et al. (1970)
Midwest	1977	Whipped butter	>100	A	Francis et al. (1977)
Kentucky	1985	Chocolate milk	>860	NR	Lecos (1986)
Southwest	1991	Butter-blend spread	>265	A ^a	Khambaty et al. (1994)
Foreign					
Canada	1977	Emmental cheese	15	B	Todd et al. (1981)
England	1983	Unspecified cheese	30	NR	Barrett (1986)
France	1983	Sheep's milk cheese	20	NR	Sharp (1987)
Scotland	1984/1985	Sheep's milk cheese	28	A	Bone et al. (1989)
Czechoslovakia	1986	Ice cream	>16	A	Kristufkova and Simkovicova (1988)
Egypt	1986	Nonfat dry milk	>21	A, B	El-Dairouty (1989)
Israel	1987	Goat's milk	3	B	Gross et al. (1988)
Brazil	1987	Minas-type cheese	NR	A, B, D, E	Sabioni et al. (1988)
Brazil	1994	Minas-type cheese	7	H	Pereira et al. (1996)
Japan	2000	Milk	~13,400	NR	

NR, not reported.

^a*S. intermedius*.

ative agent in the most recent outbreak. In the remaining epidemic (Evenson et al., 1988), more than 850 school children in Kentucky became ill after consuming half pints of pasteurized 2% chocolate milk containing extremely low levels of enterotoxin A.

Reports of dairy-related staphylococcal poisoning are not limited to the United States. Between 1951 and 1970, a total of 30 dairy-related outbreaks involving raw milk (20 outbreaks/590 cases/2 deaths), dried milk (2 outbreaks/1100 cases), canned milk (1 outbreak/70 cases), cream (6 outbreaks/131 cases), and ice cream (1 outbreak/8 cases) were documented in England and Wales, with an additional 23 milk- and 5 cheese-related outbreaks identified between 1969 and 1990 (Galbraith et al., 1982; Parry, 1966; Steede and Smith, 1954; Wieneke et al., 1993). According to Maguire (1993), 18 of 31 cheese-related outbreaks of illness reported in England and Wales from 1951 to 1989 were the result of staphylococcal poisoning. Although now an unusual occurrence in most industrialized countries, the largest dairy-related outbreak of staphylococcal food poisoning reported to date occurred during the spring of 2000 when ~13,400 cases in Japan were traced to consumption of powdered skim milk that became contaminated with raw milk during a 3-h power outage.

5. Occurrence and Survival in Dairy Products

Staphylococci are frequent contaminants of raw milk, with *S. aureus* being widely recognized as a common cause of clinical and subclinical mastitis in dairy cattle, sheep, and goats. The mammary gland represents an important reservoir for *S. aureus*, with up to 15 and 83% of raw milk samples from mastitic dairy cattle (Garcia et al., 1980; Olson et al., 1970) and sheep (Guitierrez et al., 1982), respectively, harboring enterotoxigenic strains. According to surveys conducted in Brazil (dos Santos et al., 1981) and Trinidad (Adesiyun, 1994), *S. aureus* was present in 47 and 94%, respectively, of the raw milk samples at populations typically ranging between 10^5 and 10^6 cfu/mL. In the latter study, 9 of 117 *S. aureus* isolates produced enterotoxins A, B, or D. Growth and enterotoxin production by *S. aureus* in fluid milk are strain dependent and strongly influenced by incubation temperature and initial microbial load. Although *S. aureus* is unable to multiply in naturally contaminated raw milk during refrigerated storage, Clark and Nelson (1961) reported that *S. aureus* populations increased as much as 1000-fold when raw milk was held at 10°C for 7 days. Even though it is readily inactivated during high-temperature, short-time and vat pasteurization (Zottola et al., 1969), *S. aureus* can enter such products as a postpasteurization contaminant as evidenced by the aforementioned outbreaks and a survey from Brazil (dos Santos et al., 1981) in which 6% of pasteurized milk samples harbored *S. aureus* at levels of 10^2 – 10^4 cfu/mL. In the absence of a large background flora, *S. aureus* growth is enhanced with enterotoxin detectable in inoculated samples of pasteurized whole milk, skim milk, half and half, and cream after 18–24 h of incubation at

37°C (Halpin-Dohnalek and Marth, 1989b, 1989c; Ikram and Luedecke, 1977; Minor and Marth, 1972; Varadaraj and Nambudripad, 1983). Decreasing the storage temperature to 22–25°C decreased *S. aureus* growth with all four products being nontoxic after 16–24 h. More than 2 days of incubation were required to detect enterotoxin in half and half and in cream.

Large numbers of *S. aureus* are seldom found in ice cream (Massa et al., 1989), nonfat dry milk (Chopin et al., 1978), or butter (Minor and Marth, 1972), because product composition and storage conditions severely limit growth. However, enterotoxin can persist for several years in nonfat dry milk prepared from contaminated fluid milk (Chopin et al., 1978), with staphylococcal enterotoxin also remaining fully active in ice cream during 7 months of frozen storage (Gogov et al., 1984). In butter prepared from inoculated cream (Minor and Marth, 1972) and whey cream (Halpin-Dohnalek and Marth, 1989a), *S. aureus* populations seldom increased more than 100-fold, with numbers more often remaining stable or decreasing during 2 weeks of storage at temperatures ranging from 4 to 30°C. Whereas enterotoxin production is clearly minimal under these conditions, Minor and Marth (1972) reported that when cream was inoculated with *S. aureus*, incubated at 37°C for 24 h, and then churned into butter, the finished product contained at least 1 µg of enterotoxin/100 g or approximately 10% of the enterotoxin originally present in the cream. Because 0.1 µg of enterotoxin can reportedly induce symptoms of staphylococcal poisoning (Eversen et al., 1988), ingesting such butter does pose a potential health risk as demonstrated by the recent butter-related outbreaks.

Enterotoxigenic staphylococci are occasionally found in cheese, as evidenced by the aforementioned outbreaks. In several early surveys, 12–20% of Cheddar cheese sold in the United States contained potential enterotoxigenic strains of *S. aureus*, sometimes at levels exceeding 200,000 cfu/g, with raw milk cheeses being contaminated most often (Donnelly et al., 1964; Mickelsen et al., 1962). However, stricter measures for controlling and preventing staphylococcal mastitis in dairy cattle have sharply reduced these contamination rates over the past 20 years, with less than or equal to 2% of samples tested in the United States (Bowen and Henning, 1994; Khayat et al., 1988) and Canada (Brodsky, 1984a, 1984b; Warburton et al., 1986) containing *S. aureus* populations exceeding the maximum allowable level (Canadian) of 1000 cfu/g. However, this pathogen is still commonly found in certain raw milk cheeses manufactured abroad (Abbar and Mohammed, 1986; Ocando et al., 1991; Sanchez-Rey, 1993).

Starter culture growth and activity have a pronounced inhibitory effect on proliferation of *S. aureus* during cheese making. When Cheddar cheese was prepared from pasteurized milk inoculated to contain less than 1000 enterotoxigenic *S. aureus* cfu/mL, Koenig and Marth (1982) found that populations increased approximately 1000- and 10,000-fold using a 1.0% and 0.5% starter culture inoculum, respectively. An initial 10-fold increase resulted from physical entrapment of *S. aureus* in the curd with subsequent growth generally ceasing within 8 h at

a pH less than or equal to 5.3. During 8 weeks of ripening at 4°C, *S. aureus* levels decreased 100- to 1000-fold in cheese prepared without salt; whereas populations remained relatively stable in cheese containing 1–2% NaCl because of the adverse effects of salt on less salt-tolerant background flora. Nevertheless, virtually all 8-week-old cheeses were positive for enterotoxin, with the highest toxin levels being recorded in high-salt cheeses ripened at 10°C. These findings are consistent with those of Ibrahim et al. (1981a, 1981b), who also reported that, in the event of starter culture failure, *S. aureus* growth and enterotoxin production can be minimized by eliminating salt and limiting exposure of the cheese to ambient temperatures during pressing. Similar behavior of *S. aureus* has been reported during manufacture and storage of a wide variety of experimentally produced cheeses, including Monterey (Eckner et al., 1991), brick (Tatini et al., 1973), Swiss (Tatini et al., 1973), Gouda (Stadhouders et al., 1978), Camembert (Meyrand et al., 1998), Feta (Erkmen, 1995), Brazilian Minas (dos Santos and Genigeorgis, 1981), Sudanese soft-brined cheese (Khalid and Harrigan, 1984), Spanish Burgos (Nunez et al., 1986; Otero et al., 1988), Spanish Manchego (Gomez-Lucia et al., 1986, 1992), Spanish goat (Mor-Mur et al., 1992), Egyptian Ras (Naguib et al., 1979), and Egyptian Domiati cheese (Ahmed et al., 1983b; Helmy et al., 1975). However, in several other studies involving mozzarella (Tatini et al., 1973), blue (Tatini et al., 1973) and Italian Montasio (Stecchini et al., 1991), no enterotoxins were detected even though *S. aureus* grew to populations of more than 10⁷ cfu/g during cheese making.

6. Prevention

Given that *S. aureus* is ubiquitous within the farm environment and carried by approximately half of the human population, many dairy products contain low levels of enterotoxigenic staphylococci. However, growth and enterotoxin production are both easily prevented by proper refrigeration, with temperature abuse above 10°C and poor starter culture activity during fermentation being most often cited as contributing factors in dairy-related outbreaks of staphylococcal poisoning. Increased recognition of staphylococcal mastitis in dairy cattle, coupled with improvements in milk handling, cooling, and pasteurization practices, has made dairy-related outbreaks of staphylococcal food poisoning an uncommon occurrence in the United States and most other industrialized countries. However, such outbreaks have been observed in less developed countries, with raw milk cheeses being implicated most often. Hence, consumption of raw milk dairy products should be avoided.

L. Yersiniosis

The genus *Yersinia*, formed in 1944 and named after the French bacteriologist Yersin, who isolated the plague bacillus in 1894, contains 11 different species,

3 of which are unquestionably human pathogens (Gray, 1995; Scheimann, 1989). *Y. pestis*, the causative agent of bubonic plague (The Black Death), is spread by the bite of infected rat fleas and has ravaged mankind throughout recorded history. First identified in 1883, *Y. pseudotuberculosis* is biochemically similar to *Y. pestis*. Most commonly found in rats and birds, *Y. pseudotuberculosis* occasionally infects humans, causing septicemia, acute gastroenteritis and “pseudoappendicitis,” with internal lesions resembling those observed during intestinal tuberculosis (Christie and Corbel, 1990). However, supporting evidence for *Y. pseudotuberculosis* as a foodborne pathogen is limited to two reports (Jones et al., 1982; Prober et al., 1979) in which the organism was detected in milk from mastitic goats. *Y. enterocolitica*, the primary cause of *Yersinia*-related foodborne gastroenteritis, hereafter termed yersiniosis, was first identified in a human facial lesion in the United States by Schleifstein and Coleman (1939). The name of the organism changed from *Bacterium enterocolitica* to *Pasteurella X* and finally to *Y. enterocolitica* in 1964. However, this pathogen was not widely recognized as a common cause of foodborne gastroenteritis until the 1970s (Schiemann, 1989), with most cases being linked to pork, because hogs are the major reservoir for human pathogenic strains. Since 1972, three outbreaks in the United States and one outbreak in Canada were traced to consumption of milk products with more than 500 people being affected. Although readily capable of growing at refrigeration temperatures, *Y. enterocolitica* is generally regarded as an unusual cause of milkborne illness because of the low incidence of human pathogenic strains in the raw milk supply and the high susceptibility of the organism to pasteurization.

1. General Characteristics

A species in the family Enterobacteriaceae, *Y. enterocolitica* is a gram-negative, non-spore-forming, sometimes encapsulated, facultatively anaerobic, rod-shaped bacterium that is motile at 25 but not at 37°C and moves by means of peritrichous flagella (Christie and Corbel, 1990; Farrag and Marth, 1992; Schiemann, 1989). This organism grows at 0–45°C, with best growth at 30–37°C. However, multiplication in this latter temperature range is slower than for other enteric pathogens, including *E. coli* and *Salmonella*. Like *L. monocytogenes*, the ability of *Y. enterocolitica* to grow in pasteurized whole milk stored at 3°C (Stern et al., 1980) makes this organism a potential health threat in refrigerated dairy products. In addition, *Y. enterocolitica* also grows or survives at pH 4.6–9.6, with optimal growth occurring at pH 7.0–8.0. Both of these growth characteristics have been used to selectively isolate this organism from food samples. Fermentation of sucrose, cellobiose, and sorbose can be used to biochemically differentiate *Y. enterocolitica* from *Y. pestis* and *Y. pseudotuberculosis*.

Many *Y. enterocolitica* isolates recovered from food samples are avirulent and of no clinical importance. These nonpathogenic strains, which typically lack

a virulence-carrying plasmid and two chromosomal genes encoding for cell invasion factors, abound in raw milk and must be differentiated from strains capable of causing disease (Schiemann, 1987). Eight additional biochemical tests can be used to subdivide *Y. enterocolitica* isolates into seven distinct biochemical types (biotypes), with biotypes 1B, 2, 3, 4, and 5 containing human pathogenic strains (Weagant et al., 1998). Alternatively, the presence or absence of somatic (O) antigens can be used to separate *Y. enterocolitica* isolates into 54 serotypes (Weagant et al., 1998), 12 serotypes of which contain human pathogenic strains. Serotypes most frequently encountered in human infections include O:3, O:5,27, O:8 and O:9.

2. Isolation and Detection Methods

Several different procedures can be used to recover yersiniae from dairy products (Schiemann and Wauters, 1992), with most of these methods exploiting the ability of the organism to grow at reduced temperatures and survive in an alkaline environment. In the standard procedure for dairy products (Flowers et al., 1992a; Weagant et al., 1995), the sample is enriched in peptone sorbitol bile broth. After 10 days of incubation at 10°C, a portion of the enrichment is treated with 0.5% potassium hydroxide to reduce the background flora and then is surface plated on two selective plating media—MacConkey agar (MAC) and Cefsulodin-Irgasan-Novobiocin agar (CIN). However, when high levels of yersiniae are expected, it is recommended that samples be plated before beginning the 10-day enrichment step. All plates are examined for suspect colonies after 48 h of incubation at 22–26°C. Presumptive *Yersinia* colonies on MAC and CIN are confirmed as *Yersinia* spp. based on reactions in lysine arginine iron agar, urea agar, and bile esculin agar. Results from six additional biochemical tests are required to identify *Y. enterocolitica*, with eight further biochemical tests required to separate isolates into six different biotypes. Potentially virulent strains belonging to biotypes 1B, 2, 3, 4, and 5 need to be confirmed as pathogenic through either dye binding, specific gene probe, cell culture, or mouse inoculation assays. Serotyping is normally confined to isolates of epidemiological importance and conducted by only qualified reference laboratories.

3. Clinical Manifestations

Yersiniosis, the disease caused by infection with *Y. enterocolitica*, can assume many different forms depending on strain and dose of the organism as well as age and physical condition of the person infected (Christie and Corbel, 1990; Gray, 1995; Schiemann, 1989). The most frequent manifestation of yersiniosis is gastroenteritis, which primarily affects children younger than 7 years of age; infants in their first year of life are most susceptible. Symptoms that develop 12–72 h after ingesting more than 10⁹ organisms (D'Aoust, 1989) typi-

cally include a low fever, diarrhea, severe abdominal pain, and cramps, with nausea and vomiting being reported less frequently. Although this illness is normally self-limiting and of short duration, with symptoms subsiding after 1–3 days, intestinal complications have been reported. Severe abdominal pain in older children is often mistaken for appendicitis, and a normal or only mildly inflamed appendix is sometimes removed. Such individuals also normally exhibit enlarged mesenteric lymph nodes and acute terminal ileitis, sometimes with involvement of the colon. Although relatively rare, intestinal obstruction, gangrene of the small intestine, and peritonitis have been reported as additional complications.

Acute generalized septicemia, the second major manifestation of yersiniosis, occurs far less frequently and is most often seen in elderly patients suffering from severe underlying illnesses such as alcoholism, liver disease, hemolytic anemia, leukemia, and other immunosuppressive disorders (Christie and Corbel, 1990; Schiemann, 1989). However, several reports of septicemic infection also have involved healthy infants. Despite proper antibiotic therapy, the mortality rate for such infections is still more than 50%.

Secondary complications develop in approximately 5% of all yersiniosis patients with reactive arthritis and skin infections being reported most frequently (Christie and Corbel, 1990; Schiemann, 1989). Other complications include endocarditis, thyroid disorders, eye infections, glomerulonephritis, liver disease, respiratory infections, muscle abscesses, and osteomyelitis.

Isolation of *Y. enterocolitica* from stool samples or from normally sterile materials such as blood and various organ tissues provides definitive diagnosis, with serological tests offering another alternative (Christie and Corbel, 1990; Gray, 1995; Schiemann, 1989). Administration of antibiotics is contraindicated for uncomplicated cases of gastroenteritis. However, prompt and sustained antibiotic therapy with chloramphenicol or tetracyclines is essential if patients with septicemia and severe localized infections are to fully recover.

4. Outbreaks

Evidence supporting *Y. enterocolitica* as a potential milkborne pathogen dates back to 1975 (Table 10) when raw milk was epidemiologically linked to 138 cases of yersiniosis in Canadian school children after a class field trip (deGrace et al., 1976). However, because clinical and milk isolates belonged to serotypes O:5,27 and O:6,30, respectively, the incriminated raw milk could not be positively identified as the vehicle of infection (Kasatiya, 1976).

Any doubt regarding *Y. enterocolitica* as a milkborne pathogen ended in autumn of 1975 when chocolate milk from a school cafeteria was linked to 217 cases of yersiniosis in upper New York state (Black et al., 1978). Sixteen of 36 children who required hospitalization had unnecessary appendectomies. Recov-

Table 10 Major Outbreaks of Milkborne Yersiniosis

Location	Year	Product	Number of cases	Serotype	Reference
Montreal, Canada	1975	Raw milk	58	O:5,27	de Grace et al. (1976)
New York	1976	Chocolate milk	36	O:8	Black et al. (1978)
New York	1981	Powdered milk	239	O:8	Shayegani et al. (1983)
Tennessee, Arkansas, Mississippi	1982	Pasteurized milk	172	O:13	Tacket et al. (1984)
Vermont, New Hampshire	1995	Pasteurized milk	10	O:8	Ackers (1995)
England	1985	Pasteurized milk	36	O:10K and O:6,30	Greenwood and Hooper (1990)

ery of *Y. enterocolitica* O:8 from numerous patients and unopened containers of the incriminated milk confirmed pasteurized chocolate milk as the vehicle of infection. Subsequent investigation of the dairy factory suggested that the epidemic strain most likely entered the product when chocolate syrup was added to previously pasteurized milk and mixed by hand in an open vat.

Six years later, another large milk-related outbreak occurred at a New York state summer camp with gastroenteritis developing in 239 of 455 campers and staff members (Shayegani et al., 1983). Five of seven victims requiring hospitalization had appendectomies before this epidemic was diagnosed as yersiniosis. Epidemiological findings suggested a common source for this outbreak, with *Y. enterocolitica* O:8 being recovered from more than half of the patients and eventually found in reconstituted powdered milk, a milk dispenser, and turkey chow mein. These findings and additional results from pathogenicity studies both supported the aforementioned foods as potential vehicles of infection in this outbreak, with isolation of the epidemic strain from 4 of 11 food handlers suggesting contamination during food preparation.

The largest and most unusual outbreak of milkborne yersiniosis occurred during the summer of 1982 in Tennessee, Arkansas, and Mississippi (Tacket et al., 1984). According to the report, 172 cases of *Y. enterocolitica* infection were culturally confirmed, with the total number of cases estimated at several thousand. Unlike the aforementioned outbreaks, infections in 14 individuals were confined to a sore throat and fever with no symptoms of gastroenteritis (Tacket et al., 1983). In addition, the epidemic strain belonged to serotype O:13, an unusual serotype previously recognized only in monkeys, and was resistant to many antibiotics. No yersiniae were found in the incriminated milk, which was properly pasteurized. However, after learning that the factory delivered unsold milk to a farm for feeding pigs, investigators recovered the epidemic strain from the bottom of several returned milk crates (Auliso et al., 1982). As a result of inadequate crate washing procedures, the tops of the milk bottles likely became contaminated when the crates were stacked. Given that *Y. enterocolitica* can survive on the outside of refrigerated milk cartons for at least 21 days (Stanfield et al., 1985), the organism likely entered the product during consumer handling and then grew to infectious levels during refrigerated storage.

During October 1995, pasteurized milk was also epidemiologically linked to 10 cases of yersiniosis in Vermont and New Hampshire, with the epidemic strain identified as *Y. enterocolitica* O:8 (Ackers, 1995). Investigators traced the milk to a single dairy processing facility in New Hampshire but were unable to recover the organism from pasteurized milk. Although the milk was packaged in bulk containers and glass bottles, only the latter milk was associated with illness. Given factory records indicating proper pasteurization, *Y. enterocolitica* presumably entered milk during bottling, with the epidemic strain possibly coming from a dairy farm on which pigs were also raised.

Additional outbreaks of milkborne yersiniosis are limited to three reports from England and Wales, two of which involved a total of five cases and were linked to pasteurized milk (Barrett, 1986; Barrett, 1989). In the remaining outbreak, gastroenteritis developed in 36 hospitalized children after they consumed pasteurized milk contaminated with *Y. enterocolitica* O:10K and O:6,30 (Greenwood and Hooper, 1990). The incriminated milk was delivered to the hospital in glass bottles from a single supplier. Although both epidemic strains were detected in the incoming raw milk supply, the milk was properly pasteurized, with additional thermal inactivation studies demonstrating complete destruction of yersiniae (Greenwood et al., 1990). After finding the bottle-washing procedure to be unsatisfactory, investigators concluded that the epidemic strain most likely entered milk as a postpasteurization contaminant.

5. Occurrence and Survival in Dairy Products

Domestic animals are widely recognized as fecal carriers of yersiniae, with pigs being identified as the primary reservoir for pathogenic strains of *Y. enterocolitica* (Schiemann, 1989). According to Davey et al. (1983), 62 of 124 (50%) healthy dairy cows in Scotland were fecal shedders of yersiniae. However, only 3 of 74 (4%) *Y. enterocolitica* isolates belonged to serotypes associated with the aforementioned outbreaks of milkborne yersiniosis.

Yersiniae are frequent contaminants of raw milk. Because this organism is not known to cause mastitis in dairy cattle, most contamination is thought to occur through contact with feces or polluted water (Schiemann, 1989). In two surveys from Wisconsin, Michigan, and Illinois (McManus and Lanier, 1987; Moustafa et al., 1983b), *Y. enterocolitica* was demonstrated in 12 and 48% of the raw milk supply. However, none of the isolates was virulent. Working in Canada, Schiemann and Toma (1978) detected *Y. enterocolitica* in 29 of 131 (22%) raw milk samples. In contrast to the American surveys, seven different serotypes were recovered, all of which were previously associated with cases of human yersiniosis in Canada. Elsewhere, *Y. enterocolitica* has been identified in 5.5–36.6% of raw milk samples analyzed in Brazil (dos Reis Tassinari, 1994; Tibana et al., 1987), Northern Ireland (Walker and Gilmour, 1986), and Morocco (Hamama et al., 1992), with this organism also being recovered from 36–81.4% of raw milk samples tested in France (Desmaures et al., 1997; Vidon and Delmas, 1981). In addition, 5% of Spanish (Tornadijo et al., 1993) and 12.8% of Australian (Hughes and Jensen, 1980) raw goat's milk samples also harbored *Y. enterocolitica*. Even though very few raw milk samples from these surveys contained human pathogenic strains, *Y. enterocolitica* is still one of the most frequent raw milk contaminants of public health concern.

Compared with other milkborne pathogens, *Y. enterocolitica* is relatively heat sensitive with current minimum high-temperature, short-time and vat pas-

teurization standards being sufficient to inactivate unusually high populations of clinically important strains in milk (D'Aoust et al., 1988; Francis et al., 1980; Hanna et al., 1977; Lovett et al., 1982; Toora et al., 1992). Consequently, the occasional presence of yersiniae in properly pasteurized dairy products is indicative of postpasteurization contamination. According to Archer (1988), *Yersinia* spp. were recovered from 10 of 351 (2.9%) pasteurized milk, 5 of 80 (6.3%) chocolate milk, and 1 of 232 (0.4%) ice cream samples, with these organisms being absent from butter, cottage cheese, and nonfat dry milk. Although similar findings have been reported from Canada (Schiemann, 1978) with only 1 of 265 (0.4%) pasteurized dairy product samples positive for *Y. enterocolitica*, contamination rates as high as 6% have been reported from Northern Ireland (Walker and Gilmour, 1986) and Brazil (Tibana et al., 1987). Many of these isolates presumably were nonpathogenic serotypes.

As was true for *L. monocytogenes*, *Y. enterocolitica* also can grow in milk during refrigeration and thus pose a potential health hazard. When pasteurized milk was inoculated to contain 10 *Y. enterocolitica* cfu/mL and refrigerated at 4°C, Amin and Draughon (1987) found that the population doubled every 19 h and reached 10⁶ cfu/mL after 14 days of storage. Furthermore, *Y. enterocolitica* was able to readily compete with the natural background flora. Given these findings and an additional report indicating that *Y. enterocolitica* was present in 4.9–19.9% of environmental samples collected from dairy factory floors and coolers (Pritchard et al., 1995), special precautions are needed to minimize contamination and subsequent growth of this organism to potentially hazardous levels in fluid dairy products.

Yersiniae are seldom recovered from fermented dairy products. According to Brodsky (1984a), only 1 of 127 (0.8%) 60-day-old samples of Canadian raw milk Cheddar cheese harbored *Y. enterocolitica*, with the isolate being nonpathogenic. In addition, Schiemann (1978) failed to recover *Y. enterocolitica* from 49 samples of Canadian-produced Cheddar and Italian cheese. These findings, along with a lack of reported outbreaks, suggest that fermented dairy products manufactured under good sanitary conditions are generally safe. However, the risk of yersiniosis may be somewhat higher in less developed countries, with 4–5% of traditional Moroccan fermented milk products and raw milk cheeses (Hamama et al., 1992) as well as 28.8% of feta-type cheeses produced in Turkey (Aytac and Ozbas, 1992) containing *Y. enterocolitica*.

Pathogenic strains of *Y. enterocolitica* can persist in fermented dairy products for various lengths of time depending on initial inoculum level, starter culture level, storage temperature, pH, salt content, and environmental conditions. When pasteurized milk for Colby cheese manufacture was inoculated to contain 10²–10³ *Y. enterocolitica* cfu/mL, populations increased 1000-fold during cheese making, with one strain surviving at least 8 weeks in cheese ripened at 3°C (Moustafa et al., 1983a). This organism also can proliferate on the surface of

ripened Brie cheese during storage at 4–20°C (Little and Knochel, 1994). Although *Y. enterocolitica* is unable to survive the cooking step in cottage cheese manufacture (Golden and Hou, 1996), contamination during packaging can lead to substantial growth, with yersiniae persisting throughout the normal shelf life of the product (Sims et al., 1989). However, survival of *Y. enterocolitica* in yogurt prepared from inoculated milk is limited to 6 days or less depending on rate of acid development, final pH, and type of starter culture used (Bodnaruk, 1998; Mantis et al., 1982; Williams et al., 1996).

6. Prevention

Pasteurization readily destroys both pathogenic and nonpathogenic strains of yersiniae and, as such, provides the primary means of defense against milkborne yersiniosis. However, given the high incidence of yersiniae in dairy processing facilities and the ability of *Y. enterocolitica* to reach hazardous levels in fluid dairy products during refrigerated storage, it is imperative that postpasteurization contamination be minimized. Whereas consumption of raw milk should again be avoided, any risks associated with fermented dairy products appear to be minimal.

IV. UNCOMMON AND SUSPECTED CONCERNS

During the early 1900s, reported milkborne illnesses were confined to a small number of classic diseases, principally diphtheria, scarlet fever, tuberculosis, and typhoid fever, with the importance of other milkborne pathogens such as *Salmonella* and *S. aureus* not being fully realized until the late 1940s. Subsequent improvements in microbial isolation and detection techniques coupled with refinements in investigative strategies for foodborne outbreaks during the 1980s led to identification of such organisms as *E. coli* O157:H7, *L. monocytogenes*, and *Y. enterocolitica* as important milkborne pathogens. Although major public health concerns discussed in the preceding section easily account for more than 95% of all dairy-related illnesses of known cause, the list of “new” and “emerging” milkborne pathogens continues to evolve. Consequently, this section briefly discusses 14 additional uncommon or suspected concerns of potential public health significance which represent milkborne pathogens and toxins (e.g., *Citrobacter freundii*, *Corynebacterium ulcerans*, Johne’s and Crohn’s diseases, mycotoxins, toxoplasmosis), long-known disease agents of infrequent illness (e.g., Haverhill fever, Q fever, shigellosis), emerging agents of milkborne disease (e.g., histamine poisoning, *Streptococcus zooepidemicus*), and disease agents for which milk and dairy products can serve as potential vehicles of infection (e.g., Creutzfeldt-Jakob disease, cryptosporidiosis, infectious hepatitis, tickborne encephalitis).

A. *Citrobacter freundii*

Classified among the gram-negative enterics, *C. freundii* is a well-recognized opportunistic pathogen that normally inhabits the gastrointestinal tract of both humans and animals (Stiles, 1989). However, gastroenteritis caused by *C. freundii* is typically confined to those strains that have acquired plasmids for enterotoxin and verotoxin production (Tschape et al., 1995), colonization factors, or other pathogenic mechanisms. Following an incubation period of 12–48 h, symptoms of *C. freundii* gastroenteritis, in descending order of frequency, include diarrhea, abdominal pain, fever, chills, headache, vomiting, and nausea (Bryan, 1979), with spontaneous recovery occurring within 7 days (Stiles, 1989). Sporadic cases of milkborne *C. freundii* gastroenteritis were first suspected during the 1940s (Edwards et al., 1948), with a subsequent outbreak involving 14 adults eventually being traced to milk (Sedlak, 1973). In 1983, three separate outbreaks of gastroenteritis affecting 45 people in Washington, DC, were linked to one particular brand of imported French Brie cheese (Levy et al., 1983). Despite extensive testing for routine foodborne pathogens, *C. freundii* was the only organism common to both the cheese and three victims, thus supporting possible involvement of *C. freundii* in this outbreak.

B. *Corynebacterium ulcerans*

First isolated from human throat lesions in 1927 (Hart, 1984), *C. ulcerans* is considered a variant of *C. diphtheriae* and is able to produce several toxins associated with *C. diphtheriae* and *C. pseudotuberculosis* (Stiles, 1989). Cases of human illness have been reported only occasionally, with *C. ulcerans* producing pharyngitis of varying severity and, in a few instances, an illness that mimics diphtheria (Hart, 1984). Even though it is considered a highly unusual cause of mastitis in dairy cattle, *C. ulcerans* has been recovered from raw milk (Wilson and Richards, 1980), with ingestion of such milk accounting for most human infections (Hart, 1984; Meers, 1979). Hence, this illness can be classified as a zoonosis.

C. Creutzfeldt-Jakob Disease

The principal form of human spongiform encephalopathy is Creutzfeldt-Jakob disease (CJD), an extremely rare neurodegenerative disorder characterized by rapidly progressive dementia and movement disorder followed by death within 4 months of onset. Unlike other diseases discussed thus far, the causative agent of CJD is an infectious proteinaceous particle known as a “prion” rather than a bacterium, parasite, or virus. Recognized worldwide, the annual incidence in

the United Kingdom is 0.5–1.0 case per million population. Most cases are of unknown origin and observed most frequently in individuals 55–75 years of age (Patterson and Painter, 1999).

In 1996, 10 cases of a somewhat different form of CJD, termed new variant Creutzfeldt-Jakob disease (nv-CJD), were reported in the United Kingdom. Given the absence of other predisposing factors for CJD (i.e., heredity, hormonal therapy, surgical grafts) and appearance of bovine spongiform encephalopathy (BSE) in British cattle 10 years earlier, a link between BSE and nv-CJD could not be excluded. In 1997, the first results were published from strain-typing experiments initiated in mice 1 year earlier (Bruce et al., 1997). Case profiles of nv-CJD in terms of incubation period and lesion type were identical to those from BSE, indicating that nv-CJD can be regarded as a human form of BSE. Confirmation of 700 BSE cases in the United Kingdom during 1985–1988 prompted a ban on certain ruminant feed. Nevertheless, the number of BSE cases continued to increase, peaking at over 36,000 in 1992 before declining to about 4000 in 1997 for a total of 170,000 cases reported during this 13-year period. Since 1995, at least 36 cases (over 80 cases by early 2001) of human nv-CJD have been confirmed in the United Kingdom with several additional cases being diagnosed in France (Pattison, 1999).

These reports from the mid 1990s regarding human cases of nv-CJD in England and France and the link to the agent that causes bovine spongiform encephalopathy have raised many questions regarding the safety of animal-derived products and by-products that enter the food chain. Given the theory that transmission of nv-CJD could result from consuming animal tissues containing high levels of the infectious prion, a series of economically devastating laws were adopted by the European Union that forbid and/or severely restrict exportation of British cattle, beef, and related animal by-products. Thus far, it should be emphasized that no single case of nv-CJD has been directly linked to consumption of beef or animal by-products in the United Kingdom or elsewhere. Although the safety of the milk supply also has been questioned (Collee and Bradly, 1997), as of February 2001, no cases of nv-CJD have been associated with consumption of milk or dairy products. Furthermore, no evidence exists for shedding of the infectious prion in milk. Consequently, the risk of contracting nv-CJD in the United States from milk and dairy products appears to be minuscule given the current absence of BSE in United States cattle along with import regulations that restrict movement and sale of potentially contaminated animal feed and animal products (Tan et al., 1999).

D. Cryptosporidiosis

Protozoan parasites in the genus *Cryptosporidium* are responsible for one of the most common, acute, self-limiting gastrointestinal infections in healthy individu-

als, with 30–35% of the United States population being seropositive for this organism (Smith, 1993). Wild and domestic animals, including cows, sheep, and goats, are also highly susceptible to such infections (Tzipori, 1983). The entire life cycle of *Cryptosporidium* occurs within a single host with greater than 10^8 infectious oocysts eventually shed in feces and deposited in the environment to infect the next host by inhalation or ingestion. Infectivity of *Cryptosporidium* oocysts is best maintained under cool moist conditions (Smith, 1993). Exposure to temperatures less than 0°C or greater than 65°C inactivates the organism. Even though pasteurization of milk ($71.7^\circ\text{C}/15\text{s}$) results in lost infectivity (Harp et al., 1996), an extremely thick outer wall makes cryptosporidia oocysts highly resistant to most commonly used sanitizers, including chlorine.

After ingesting as few as 10 cryptosporidia oocysts, a short-term gastrointestinal illness characterized by profuse watery diarrhea, abdominal cramps, vomiting, mild fever, and headache typically develops in infants and immunocompetent adults and symptoms resolve spontaneously within 1–2 weeks (Jokippi and Jokippi, 1986; Smith, 1993). However, a persistent cholera-like diarrhea and other potentially life-threatening complications frequently develop in elderly and immunocompromised patients.

Evidence for cryptosporidiosis as a milkborne disease is growing, with at least three outbreaks (43 cases) outside of the United States being epidemiologically linked to consumption of raw milk from cows (Casemore et al., 1986; Elsser et al., 1986) and goats (Anonymous, 1984c). More recently, 50 cases of cryptosporidiosis in British children were epidemiologically linked to school milk that was improperly pasteurized at the farm (Gelletlie et al., 1997). Ingestion of kefir (a fluid milk product prepared using a mixed lactic acid and alcoholic fermentation) was responsible for 13 cases of infant cryptosporidiosis, with *Cryptosporidium* oocysts detected in filtered milk samples from the factory (Romonova et al., 1992). Thus far, dairy products have not been positively linked to any cases of cryptosporidiosis in the United States. However, in conjunction with a massive outbreak involving approximately 500,000 waterborne cases of cryptosporidiosis in Milwaukee, WI, several precautionary recalls were issued for cottage and other cheeses that may have been prepared using *Cryptosporidium*-contaminated water (Anonymous, 1993a).

E. Haverhill Fever

Streptobacillus moniliformis, the etiological agent of both Haverhill and rat-bite fever, is a gram-negative, facultatively anaerobic, highly pleomorphic, rod-shaped bacterium (Ryan, 1986). This organism and the disease were first described in 1926 after 89 cases of febrile illness in Haverhill, MA, were attributed to raw milk consumption (Parker and Hudson, 1926). However, foodborne infections involving *S. moniliformis* remain rare, with most cases acquired from the

bite of infected rats and termed rat-bite fever rather than Haverhill fever, which is foodborne (Stiles, 1989).

The onset of Haverhill fever is abrupt, with chills, headache, rash, and severe back and joint pain occurring 2–10 days after initial exposure (Ryan, 1986; Stiles, 1989). Various complications, including arthritis in 50% of patients as well as endocarditis, pneumonia, brain abscesses, anemia, severe dehydration, and severe weight loss, have been reported, particularly in children. Whereas administration of penicillin generally leads to full recovery, some of the aforementioned complications have been fatal.

Only one additional epidemic of milkborne Haverhill fever has been reported since 1926. In this outbreak, as many as 130 children attending an English boarding school became ill in February 1983 after consuming raw milk from a local farm (Shanson et al., 1983). However, as in 1926, investigators were again unable to recover *S. moniliformis* from incriminated milk. Because *S. moniliformis* grows poorly in milk (Parker and Hudson, 1926) and is readily inactivated during pasteurization (Stiles, 1989), milkborne cases of Haverhill fever are likely to remain rare.

F. Histamine Poisoning

Certain strains of lactobacilli and lactococci found in raw milk and many cheeses possess the enzyme histidine carboxylase, which can convert unbound histidine to potentially toxic levels of histamine (Stratton et al., 1991). Whereas levels of free histidine are usually very low in fresh milk, histidine concentrations in aged cheeses such as Cheddar and Swiss are often much higher from proteolysis of milk proteins during ripening (Hinz et al., 1956). Cheeses in which free histidine has been converted by certain lactic acid bacteria to greater than or equal to 100 mg histamine/100 g of cheese have been most frequently associated with histamine poisoning. However, histamine levels as low as 30 mg/100 g also have induced illness, with histamine toxicity being enhanced by several biogenic amines (e.g., tyramine, tryptamine) that potentiate histamine activity (Edwards and Sandine, 1981) and certain drugs (e.g., antihistamines, isoniazid) that inhibit histamine-metabolizing enzymes (Hui and Taylor, 1985; Stratton et al., 1991).

Biologically, histamine acts to contract smooth muscle within the intestine (Taylor, 1986) and dilate blood vessels (Stratton et al., 1991). Symptoms of histamine poisoning generally develop 30 min to 2 h after ingesting cheese containing greater than or equal to 100 mg histamine/100 g and include abdominal cramps, diarrhea, nausea, and vomiting as well as hypotension, headache, palpitations, tingling, flushing, and burning sensations in the mouth (Stratton et al., 1991). Medical intervention is usually unnecessary, with most symptoms disappearing a few hours after onset.

Dairy-related outbreaks of histamine poisoning have been confined to aged cheeses, with over 50 cases thus far reported worldwide (Stratton et al., 1991). The first of these cases occurred in 1967 in the Netherlands and was traced to 2-year-old Gouda cheese containing 85 mg of histamine/100 g (Doeglas et al., 1967). In the United States, three separate outbreaks in Washington (38 cases) (Taylor, 1985), California (1 case) (Taylor, 1985), and New Hampshire (6 cases) (Taylor et al., 1982b) were documented from 1976 to 1980, with all cases linked to Swiss cheese containing more than 100 mg of histamine/100 g. Sumner et al. (1985) subsequently recovered a histamine-producing strain of *Lb. buchneri* from Swiss cheese implicated in the New Hampshire outbreak. The remaining six cases of histamine poisoning involved Canadian Cheddar (Kahana and Todd, 1981), French Cheshire (Uragoda and Lodha, 1979), and French Gruyère cheese (Taylor, 1985) consumed in the country of origin.

Lactic acid bacteria responsible for histamine production include various strains of *Lb. acidophilus*, *Lb. delbrueckii* ssp. *bulgaricus*, *Lb. helveticus*, *Lc. lactis* ssp. *lactis* and propionibacteria (Stratton et al., 1991), all of which could potentially be used as cheese starter cultures, with such use being of obvious public health concern. These strains are assumed to be present in milk at the time of cheese making, with few such organisms thought to be postprocessing contaminants (Sumner et al., 1990). Consequently, aged cheeses prepared from raw or heat-treated milk typically contain higher levels of histamine and pose a greater public health threat than cheeses prepared from pasteurized milk (Ordonez et al., 1997).

G. Infectious Hepatitis

Hepatitis A, or infectious hepatitis, is a common infectious disease worldwide and the best known of the milk-related viral diseases, with sporadic outbreaks recorded in the United States since the 1940s (Bryan, 1983). Common-source outbreaks are most often recognized in industrialized countries where this illness is rare because of natural immunity. Typical symptoms appearing 15–50 days after exposure via the fecal-oral route include jaundice, anorexia, and extreme malaise, with some individuals also experiencing abdominal pain, nausea, fever, and chills (Hirschmann, 1986). Infectious hepatitis is usually a mild illness with bed rest leading to complete recovery within a few weeks. Despite the general lack of serious complications, some individuals with more pronounced cases may complain of fatigue for several months. According to Cliver (1979), milk and dairy products were implicated in five outbreaks (599 cases) of infectious hepatitis, with one of these reports traced to the use of fecally contaminated water in a Czechoslovakian dairy processing facility (Raska et al., 1966). Two additional outbreaks involving ice cream (MacDonald and Griffin, 1983) and cheese (Bean et al., 1996) were also recorded in the United States during 1982 and 1990, respectively.

Whereas the virus is only partially inactivated by pasteurization, complete destruction of the virus is ensured by normal chlorination (Hirschman, 1986).

H. Johne's and Crohn's Diseases

Mycobacterium paratuberculosis, a gram-positive, acid-fast bacillus, is the etiological agent of Johne's disease in dairy cattle, goats, and other ruminant animals (Collins et al., 1984; van den Heever, 1984). This economically devastating disease is characterized by a chronic granulomatous ileocolitis that eventually leads to diarrhea, weight loss, debilitation, and death (Benedictus et al., 1987; Chiodini et al., 1984). Fecal shedding of the organism at levels approaching 10^8 cfu/g leads to heavy contamination of the environment, which, in turn, helps perpetuate this disease. Although control programs have traditionally focused on minimizing consumption of contaminated feed by young calves, *M. pseudotuberculosis* is also shed in body fluids, including milk and colostrum, with as many as 35% of clinically infected cattle (Taylor et al., 1981) and 12% of asymptomatic carriers (Sweeny et al., 1992) yielding positive milk samples. Consequently, transmission of Johne's disease to calves via contaminated milk cannot be ignored.

Considerable interest has been generated concerning the possible association between Johne's disease in ruminant animals and human Crohn's disease, a nearly identical form of granulomatous ileocolitis often requiring surgical intervention (Graadal and Nygaard, 1994; Pounder, 1994). Strains of *M. paratuberculosis* similar to those identified in dairy cattle have been isolated from 20–38% of Crohn's disease patients (Chiodini and Hermon-Taylor, 1993), with the DNA of the organism also being detected in 6 and 12.5% of tissue samples obtained from patients with and without confirmed Crohn's disease, respectively (Sanderson et al., 1992). Several laboratory studies prompted by possible milkborne transmission of Crohn's disease have concluded that heat treatments simulating vat and high-temperature, short-time pasteurization do not completely inactivate *M. paratuberculosis* in milk inoculated to contain more than 10 cfu/mL (Chiodini and Herman-Taylor, 1993; Grant et al., 1996; Sung and Collins, 1998). However, Keswani and Frank (1998) subsequently reported that *M. paratuberculosis* is unlikely to survive HTST pasteurization. The public health significance of these findings and two additional reports attesting to the presence of *M. paratuberculosis* DNA in up to 7% of retail pasteurized milk samples collected in England and Wales (Grant et al., 1996; Millar et al., 1996) will not be completely understood until the relationship between *M. paratuberculosis* and certain genetic and environmental factors is fully clarified.

I. Mycotoxins

Aflatoxin, a highly potent carcinogen produced by certain strains of *Aspergillus flavus*, *A. parasiticus* and *A. nemius*, is the primary mycotoxin of public health

concern, as discussed previously. However, mycotoxin production is not limited to aflatoxigenic molds, with certain strains of *Alternaria*, *Aspergillus*, *Cladosporium*, *Fusarium*, *Geotrichum*, *Mucor*, and *Penicillium* isolated from cheese also being capable of synthesizing toxins (Scott, 1989). Several early studies demonstrated that 30 and 35% of *Penicillium* isolates from Cheddar (Bullerman and Olivigni, 1974) and Swiss cheese (Bullerman, 1976), respectively, were toxic to chicken embryos, with strains from cheese and dairy factories now known to produce a wide range of mycotoxins, including cyclopiazonic acid, citrinin, ochratoxin A, patulin, penicillic acid, and penitrem A, (Vazquez et al., 1995; Vazquez et al., 1997), all of which are either nephrotoxic, neurotoxic, teratogenic, or carcinogenic to laboratory animals (Scott, 1989). Cyclopiazonic acid is normally produced by *P. camemberti* during ripening of Camembert cheese, and patulin, penicillic acid, mycophenolic acid, and roquefortine are synthesized by certain strains of *P. roqueforti* used in manufacturing Roquefort cheese (Engel and Teuber, 1989; Lopez-Diaz et al., 1996). Although Bullerman and Olivigni (1974) identified only 6.6% of Cheddar cheese molds as *Aspergillus* spp., nearly half of these strains were toxic to chick embryos. Certain cheese isolates of *Aspergillus* have come to be recognized producers of aflatoxin as well as cyclopiazonic acid, β -nitropropionic acid, kojic acid, and sterigmatocystin (Metwally et al., 1997; Vazquez, 1995), the last of which is carcinogenic and structurally related to aflatoxin (Scott, 1989). In addition, *Fusarium* spp. are well-known producers of trichothecenes, zearalenone, and moniliformin (Ueno, 1985), with a few cheese strains of *Geotrichum* also producing ergot alkaloids (El-Refai et al., 1970).

As was true for aflatoxins, the direct impact of these remaining toxins on human health is unknown. However, because many of these mycotoxins are marginally toxic and relatively unstable in cheese (Scott, 1989), any potential public health impact is presumed to be minimal.

J. Q Fever

Coxiella burnetti, a rickettsia-like obligate intracellular parasite that localizes and proliferates within cell vacuoles, is the etiological agent of Q (Query) fever in humans (Baca and Paretzky, 1983). First observed in Australia in 1935, Q fever is now known to occur worldwide. Ticks and ruminant animals, including dairy cattle, sheep, and goats, are common asymptomatic carriers of *C. burnetti*, with most human cases being traced to dairy workers, farmers, and meat factory employees who work in close contact with animals (Serbezov et al., 1999; Wisniewski and Krumbiegel, 1970b).

Clinical symptoms of Q fever, which mimic viral influenza, generally occur 2–4 weeks after ingesting or inhaling *C. burnetti* and include an abrupt fever followed by malaise, anorexia, muscle pain, and intense headache (Turck, 1986). Even though many serious complications affecting the central nervous system,

lungs, liver, and other internal organs have been reported, most patients fully recover in 2–4 weeks when given tetracycline or chloramphenicol.

Concern regarding Q fever as a milkborne illness comes from the demonstrable presence of *C. burnetti* in milk from infected cows (Biberstein et al., 1974; Evans, 1956; Huebner and Bell, 1951; Paiba et al., 1999; Wisniewski and Krumbiegel, 1979a) and goats (Fishbein and Raoult, 1992), with regular consumers of raw milk often displaying high antibody titers to *C. burnetti* (Stiles, 1989). Ingestion of raw milk has been directly linked to Q fever in the United States (Bryan, 1983) and England (Brown et al., 1968), with the latter outbreak involving 23 cases at a detention center. More recently, a series of Q fever outbreaks were epidemiologically linked to consumption of unpasteurized goat's milk products in Bulgaria, Slovakia (Serbezov et al., 1999), and France (Fishbein and Raoult, 1992). However, given the volume of raw milk consumed worldwide, reports of milkborne Q fever are far fewer than would be expected. Furthermore, in one study in which contaminated raw milk was ingested by human volunteers, illness did not occur (Krumbiegel and Wisniewski, 1970). Several early studies also attest to the high thermal resistance of *C. burnetti* in milk, with the organism surviving 30 min of heating at 61.7°C (Huebner et al., 1949; Lennette et al., 1952). However, heating raw milk at 62.8°C for 30 min or 71.1°C for 15 s is sufficient to completely destroy *C. burnetti*, with these time-temperature pasteurization standards currently being required by law to prevent milkborne Q fever.

K. Shigellosis

Outbreaks of bacillary dysentery, which resemble present-day shigellosis, date back to the time of Hippocrates (Wachsmuth and Morris, 1989). However, *Shigella* spp. were not recognized as the cause of this disease until the late 1800s. In the family Enterobacteriaceae, the genus *Shigella* contains four species—*S. dysenteriae*, *S. flexneri*, *S. boydii*, and *S. sonnei*—all of which are highly infectious and closely related to enterohemorrhagic strains of *E. coli*. These organisms, which also produce a vero cytotoxin that is immunologically indistinguishable from *E. coli* O157:H7 Shiga-like toxin, are host adapted to humans and other primates. However, shigellae are relatively fragile and unable to compete readily with other enteric flora. This disease is usually transmitted either person-to-person or by the fecal-oral route, with food and water often serving as vectors.

Shigellosis is normally an acute, self-limiting infection of the intestinal tract. Symptoms appearing 1–7 days after ingesting up to 100 organisms (D'Aoust, 1989) typically include fever, abdominal pain, and watery diarrhea, which can develop into a fulminating dysentery characterized by grossly bloody diarrhea, dehydration, chills, and toxemia (Kantor, 1986; Wachsmuth and Morris, 1989). Children and elderly patients may go into shock from excessive dehydration, and further complications including seizures, pneumonia, hemolytic uremic

syndrome, bacteremia, peripheral neuropathy, and Reiter's syndrome (urethritis, conjunctivitis, and arthritis) may develop. Most individuals recover spontaneously within 2 weeks. Medical intervention is usually confined to replacement of fluids, with antibiotic therapy being reserved for severe cases.

A few small sporadic outbreaks of milkborne shigellosis were documented in the United States between 1920 and 1960, with this disease accounting for less than or equal to 4% of all reported milkborne illnesses (Bryan, 1979, 1983). These outbreaks generally involved raw milk that was contaminated with *S. dysenteriae* by a human carrier and then held without refrigeration for several hours. However, in 1952, improperly pasteurized milk containing *S. sonnei* was linked to one particularly large outbreak in Tennessee involving 639 school children (Tucker et al., 1954). No additional cases of milkborne shigellosis have been reported in the United States since the 1950s (Bryan, 1983), but one recent dairy-related outbreak in the former Soviet Union was traced to a milk processor's water supply that was contaminated with *S. sonnei* (Solodovnikov and Aleksandrovskaia, 1992). Other dairy products, including sour milk and white cheese, have been only rarely implicated in shigellosis. One notable outbreak did occur in 1982 in which French cheeses purchased at a Paris airport were responsible for at least 50 cases of *S. sonnei* infection subsequently reported in Scandinavia (Sharp, 1987); however, improved personal hygiene standards, pasteurization practices, and cold storage conditions serve to keep dairy-related shigellosis outbreaks as relatively rare.

L. *Streptococcus zooepidemicus*

Human infections caused by *S. zooepidemicus*, a β -hemolytic streptococcus belonging to Lancefield Group C, are generally uncommon (Stiles, 1989), with this pathogen being a more frequent cause of animal infections and subacute or chronic mastitis in dairy cattle. Because most cases of human illness have been acquired through consumption of raw milk or contact with horses (Francis et al., 1993), *S. zooepidemicus* infections can be classified as another zoonosis. In humans, *S. zooepidemicus* produces mild flulike upper respiratory symptoms as well as more serious manifestations including glomerulonephritis, cervical lymphadenitis, pneumonia, septicemia, endocarditis, meningitis, septic arthritis, and cellulitis (Francis et al., 1993). Even though such infections are usually treatable with penicillin, some fatalities have been reported, particularly among elderly patients.

Since the 1960s, five *S. zooepidemicus* outbreaks involving more than 100 cases of illness have been linked to raw milk. In the first and largest of these outbreaks, 85 individuals in a small Romanian town became ill after ingesting improperly pasteurized milk, with *S. zooepidemicus* eventually being isolated from the incriminated milk and several asymptomatic workers at the dairy processing facility (Duca et al., 1969). Three subsequent outbreaks attributed to raw

milk were reported in England. Two of these outbreaks were small and confined to family farms (Barnham et al., 1983; Ghoneim and Cook, 1980). The remaining outbreak, which involved 12 cases, including eight fatalities, was directly linked to retail raw milk, with *S. zooepidemicus* eventually traced to subclinical mastitis in the incriminated dairy herd (Edwards et al., 1988). Most recently, Francis et al. (1993) reported that three family members in Australia became ill shortly after ingesting milk from their own dairy herd. *S. zooepidemicus* isolates from family members and cow's milk were later proven identical by molecular subtyping, thereby confirming raw milk as the vehicle of infection. In 1983, 16 cases of *S. zooepidemicus* infection, including one fatality, also occurred among primarily elderly Hispanics living in New Mexico (Espinosa et al., 1983). However, unlike the previous outbreaks, illness was directly linked to fresh "queso blanco" cheese, which was illegally prepared from raw cow's milk on a small family farm and consumed without aging.

M. Tickborne Encephalitis

Tickborne encephalitis is the primary zoonotic viral disease acquired through milk. Dairy animals in central and eastern Europe can become infected through tick bites and later shed the virus in their milk (Cliver, 1979). Although readily destroyed by pasteurization, the tickborne encephalitis virus can remain infectious for many months in heat-treated milk and fermented dairy products, including cheese. In humans, a moderate fever and symptoms of encephalitis typically develop 7–14 days after ingesting the virus. During the mid-1970s, at least 17 cases of tickborne encephalitis, including one fatality, were traced to raw milk consumed in the former Soviet Union (Vasenin et al., 1975) and Poland (Jeżyna et al., 1976), with fresh sheep's milk cheese (Gresikova et al., 1975) and unboiled goat's milk responsible for three additional outbreaks in Poland (Matuszczyk et al., 1997) and Slovakia (Kohl et al., 1996).

N. Toxoplasmosis

A worldwide disease of humans and livestock, toxoplasmosis results from infection with the intracellular protozoan *Toxoplasma gondii* (Remington and McLeod, 1986). Ingesting *T. gondii* cysts or oocysts gives rise to rapid multiplication, with the organism eventually transported via the lymphatic and blood system to all body organs and tissues. Major sites of infection include the lymph nodes (lymphadenopathy), eyes (choreoretinitis), central nervous system (meningoencephalitis), lungs (pneumonia), heart (myocarditis), and kidneys (nephritis). Complications including mental retardation, blindness, and deafness have been reported, particularly in infants. The duration of treatment is determined by clinical severity of the illness, with 4–6 weeks of drug therapy being typically re-

quired. Given that milk from infected animals can harbor *T. gondii* and transmit this disease to their offspring, ingestion of raw milk also can potentially spread toxoplasmosis to humans, as evidenced by two incidents traced to raw goat's milk (Riemann et al., 1975; Sacks et al., 1982), with the latter involving a family cluster of 10 cases in northern California.

REFERENCES

- Abbar F, Kaddar HKh. Bacteriological studies on Iraqi milk products. *J Appl Bacteriol* 71:497, 1991.
- Abbar FM, Mohammed MT. Identification of some enterotoxigenic strains of staphylococci from locally processed cheese. *Food Microbiol* 3:33, 1986.
- Acedo E, Diaz ME, Leon AB. Incidence of *Brucella* spp. in raw milk and fresh cheese. *Alimentaria* 35:57, 1997.
- Ackers M. Summary report: outbreak of *Yersinia enterocolitica* infections in the Upper Valley of Vermont and New Hampshire (letter). Atlanta, GA: Foodborne and Diarrheal Diseases Branch, Centers for Disease Control and Prevention, 1995.
- Adams D, Well S, Brown EF, Gregorio S, Townsend L, Skaggs JW, Hinds MW. Salmonellosis from inadequately pasteurized milk—Kentucky. *Morbidity and Mortality Weekly Report* 33:505, 1984.
- Adams JB. Symposium: impact of drug control measures—results of drug screening from a producer's view. *J Dairy Sci* 77:1933, 1994.
- Adesiyun AA. Bacteriological quality and associated public health risk of pre-processed bovine milk in Trinidad. *Intern J Food Microbiol* 21:253, 1994.
- Ahmed AA-H, Moustafa MK, Marth EH. Incidence of *Bacillus cereus* in milk and some milk products. *J Food Prot* 46:126, 1983a.
- Ahmed AA-H, Moustafa MK, Marth EH. Growth and survival of *Staphylococcus aureus* in Egyptian Domiati cheese. *J Food Prot* 46:412, 1983b.
- Allcroft R, Carnaghan RBA. Groundnut toxicity: an examination for toxin in human food products from animals fed toxic groundnut meal. *Vet Rec* 75:259, 1963.
- Allen RF, Baer LS. Outbreak of septic sore throat due to reconstituted powdered milk. *JAMA* 124:1191, 1944.
- Allen VD, Stovall WD. Laboratory aspects of staphylococcal food poisoning from Colby cheese. *J Milk Food Technol* 23:271, 1960.
- Al-Rajab WA, Al-Dabbagh WY, Al-Zahawi SM. Occurrence of *Salmonella* in Iraqi milk products. *J Food Prot* 49:282, 1986.
- Aman IM. Stability of aflatoxin in milk samples. *Chem Mikrobiol Technol Lebensmittel* 17:161, 1995.
- Amin MK, Draughon FA. Growth characteristics of *Yersinia enterocolitica* in pasteurized milk. *J Food Prot* 50:849, 1987.
- Andersson Y, Genback H, Lindh A. A milkborne outbreak in Sweden in the summer of 1985. In: *Proceedings of the 2nd World Congress Foodborne Infections and Intoxications*. Berlin, 1986, pp 290–293.

- Andrews WH, June GA, Sherrod PA, Hammack TS, Amaguana RM. *Salmonella*. In: FDA Bacteriological Analytical Manual. 8th ed. Gaithersburg, MD: AOAC International, 1998, p 24.01.
- Angelotti R, Foster MJ, Lewis KH. Time-temperature effects on salmonellae and staphylococci in foods. *Am J Pub Health* 51:76, 1961.
- Anonymous. Tuberculosis of bovine origin in Great Britain. *BMJ* 1:618, 1932.
- Anonymous. Brucellosis 1971 annual summary. Atlanta, GA: Centers for Disease Control, 1972.
- Anonymous. *E. coli* gastroenteritis from food. *BMJ* 1:911, 1976.
- Anonymous. Milk-borne outbreaks of *Salmonella typhimurium*. *BMJ* 1:1606, 1977.
- Anonymous. *Campylobacter* enteritis—Colorado. *Morbidity and Mortality Weekly Report* 27:226, 1978.
- Anonymous. Raw-milk-associated illness—Oregon, California. *Morbidity and Mortality Weekly Report* 30:90, 1981.
- Anonymous. *Campylobacteriosis* associated with raw milk consumption—Pennsylvania. *Morbidity and Mortality Weekly Report* 32:337, 1983.
- Anonymous. *Campylobacter* outbreak associated with certified raw milk products—California. *Morbidity and Mortality Weekly Report* 33:562, 1984a.
- Anonymous. Chronic diarrhea associated with raw milk consumption—Minnesota. *Morbidity and Mortality Weekly Report* 33:521, 1984b.
- Anonymous. Cryptosporidiosis surveillance. *Weekly Epidemiol Rec* 50(10):72, 1984c.
- Anonymous. *Campylobacter* outbreak associated with raw milk provided on a dairy tour—California. *Morbidity and Mortality Weekly Report* 35:311, 1986.
- Anonymous. International Committee on Systematic Bacteriology: Subcommittee on Taxonomy of *Brucella*. Minutes of the meeting—September 5, 1986. *Int J Syst Bacteriol* 38:450, 1988a.
- Anonymous. *Campylobacter* isolates in the United States, 1982–1986. *Morbidity and Mortality Weekly Report* 37(SS-2):1, 1988b.
- Anonymous. FDA's Regulation of Animal Drug Residues in Milk—Hearing Before the Human Resources and Intergovernmental Relations Subcommittee of the Committee on Government Operations, House of Representatives 101st Congress, 2nd Session, February 6, 1990. Washington, DC: U.S. Government Printing Office, 1990.
- Anonymous. Class II recall issued for Queso Fresco Margarita Mexican style fresh white cheese. *FDA Enforcement Report* Nov 13, 1991a.
- Anonymous. *Escherichia coli* O157:H7 illness associated with consumption of farm-manufactured yogurt. *Commun Dis Rep* 1:47, 1991b.
- Anonymous. Milk and milk products recalled. *FDA Enforcement Report* Feb 20, 1991c.
- Anonymous. Salmonellosis associated with homemade ice cream in Kansas, 1992. *Kansas Med* 90:287, 1992b.
- Anonymous. Cottage and other cheeses recalled due to *Cryptosporidium*. *FDA Enforcement Report* June 9, 1993a.
- Anonymous. Update: multistate outbreak of *Escherichia coli* O157:H7 infections from hamburgers—western United States, 1992–1993. *Morbidity and Mortality Weekly Report* 42:258, 1993b.
- Anonymous. *Escherichia coli* O157:H7 outbreak linked to home-cooked hamburger—California, July 1993. *Morbidity and Mortality Weekly Report* 43:213, 1994a.

- Anonymous. Outbreak of *Salmonella* enteritis associated with nationally distributed ice cream products—Minnesota, South Dakota and Wisconsin, 1994. *Morbidity and Mortality Weekly Report* 43:740, 1994b.
- Anonymous. Summary of notifiable diseases, United States 1994. *Morbidity and Mortality Weekly Report* 43(53):1, 1994c.
- Anonymous. Brucellosis associated with unpasteurized milk products abroad. *Communicable Disease Reports* 5(32):1, 1995a.
- Anonymous. National milk drug residue data base fiscal year 1995 annual report: October 1, 1994-September 30, 1995. Arlington, VA: GLH, 1996.
- Anonymous. Number of bulk milk samples testing positive for drug residues declines. *Cheese Reporter* 121:3:3, 1999a.
- Anonymous. Summary of notifiable diseases, United States, 1998. *Morbidity and Mortality Weekly Report* 47(53):1, 1999b.
- Anonymous. Looking back on the aflatoxin situation in 1998: milk from Baden-Württemberg can be used as baby food. *Lebensmittelindustrie Milchwirtschaft* 120:573, 1999c.
- Anonymous. Milk Production: National Agricultural Statistics Service—United States Department of Agriculture. January 18, 2000.
- Applebaum RS, Marth EH. Inactivation of aflatoxin M₁ in milk using hydrogen peroxide and hydrogen peroxide plus riboflavin or lactoperoxidase. *J Food Prot* 45:557, 1982a.
- Applebaum RS, Marth EH. Use of sulfite or bentonite to eliminate aflatoxin M₁ from naturally contaminated raw whole milk. *Z Lebensm Unters Forsch* 174:303, 1982b.
- Applebaum RS, Brackett RE, Wiseman DW, Marth EH. Aflatoxin: toxicity to dairy cattle and occurrence in milk and milk products—a review. *J Food Prot* 45:752, 1982.
- Archer DL. Review of the Latest FDA Information on the Presence of *Listeria* in Foods. Geneva, Switzerland: WHO Working Group on Foodborne Listeriosis, Feb 15–19, 1988.
- Armijo R, Henderson DA, Tinothee R, Robinson HB. Food poisoning outbreaks associated with spray-dried milk—an epidemiologic study. *Am J Pub Health* 47:1093, 1957.
- Armstrong C, Parran T. Milk-borne typhoid fever—a review of cases. *Public Health Reports Supplement* 62, 1927.
- Armstrong RW, Fodor T, Curlin GT, Cohen AB, Morris GK, Martin WT, Feldman J. Epidemic *Salmonella* gastroenteritis due to contaminated imitation ice cream. *Am J Epidemiol* 91:300, 1970.
- Arocha MM, McVey M, Loder SD, Rupnow JH, Bullerman L. Behavior of hemorrhagic *Escherichia coli* O157:H7 during the manufacture of cottage cheese. *J Food Prot* 55:379, 1992.
- Aulisio CCG, Lanier JM, Chappel MA. *Yersinia enterocolitica* associated with outbreaks in three southern states. *J Food Prot* 45:1263, 1982.
- Aureli P, Fiorucci GC, Caroli D, Marchiaro G, Novara O, Leone L, Salmaso S. An outbreak of febrile gastroenteritis associated with corn contaminated by *Listeria monocytogenes*. *N Engl J Med* 342:1236, 2000.
- Aytac SA, Ozbas ZY. Isolation of *Yersinia enterocolitica* from Turkish pickled white cheese. *Austral J Dairy Technol* 47:60, 1992.

- Baca OG, Paretsky D. Q fever and *Coxiella burnetti*: a model for host-parasite interactions. *Microbiol Rev* 47:127, 1983.
- Bachmann HP, Spahr U. The fate of potentially pathogenic bacteria in Swiss hard and semihard cheeses made from raw milk. *J Dairy Sci* 78:476, 1995.
- Baker JM, Griffiths MW. Evidence for increased thermostability of *Bacillus cereus* enterotoxin in milk. *J Food Prot* 58:443, 1995.
- Bar Dayon Y, Klainbaum Y, Shemer J. Food-borne outbreak of streptococcal pharyngitis in an Israeli airforce base. *Scand J Infect Dis* 28:563, 1996.
- Barksdale L. Diphtheria bacilli and other corynebacteria. In: Braude AI, Davis CE, Fierer J, eds. *Infectious Diseases and Medical Microbiology*. Philadelphia: WB Saunders, 1986, p 254.
- Barnard R, Callahan W. Follow-up on gastroenteritis attributed to imported French cheese—United States. *Morbidity and Mortality Weekly Report* 20:445, 1971.
- Barnham M, Thornton TJ, Lange K. Nephritis caused by *Streptococcus zooepidemicus* (Lancefield Group C). *Lancet* 1:945, 1983.
- Barrett NJ. Communicable disease associated with milk and dairy products in England and Wales: 1983–1984. *J Infect* 12:265, 1986.
- Barrett NJ. Milkborne disease in England and Wales in the 1980s. *J Soc Dairy Technol* 42:4, 1989.
- Barrios MJ, Gualda MJ, Cabanas JM, Medina M, Jordano R. Occurrence of aflatoxin M₁ in cheeses from the South of Spain. *J Food Prot* 59:898, 1996.
- Barrios MJ, Medina LM, Cordoba MG, Jordano R. Aflatoxin-producing strains of *Aspergillus flavus* isolated from cheese. *J Food Prot* 60:192, 1997.
- Barrow GI, Miller DC, Johnson DL, Hingston CWJ. *Brucella abortus* in fresh cream and cream products. *BMJ* 2:596, 1968.
- Bean NH, Goulding JS, Lao C, Angulo FJ. Surveillance of foodborne disease outbreaks—United States, 1988–1992. *Morbidity and Mortality Weekly Report* 45(SS-5):1, 1996.
- Bean NH, Griffin PM, Goulding JS, Ivey CB. Foodborne disease outbreaks, 5-year summary, 1983–1987. *Morbidity and Mortality Weekly Report* 39(SS-1):15, 1990.
- Becker H, Schaller G, von Wiese W, Terplan G. *Bacillus cereus* in infant foods and dried milk products. *Intern J Food Microbiol* 23:1, 1994.
- Benedictus G, Dijkhuizen AA, Stelwagen J. Economic losses due to paratuberculosis in dairy cattle. *Vet Rec* 121:142, 1987.
- Bennett RW. *Bacillus cereus* diarrheagenic enterotoxin. In: *FDA Bacteriological Analytical Manual*. 8th ed. Gaithersburg, MD: AOAC International, 1998. p 15.01.
- Bennett RW, Lancelette GA. *Staphylococcus aureus*. In: *FDA Bacteriological Analytical Manual*. 8th ed. Gaithersburg, MD: AOAC International, 1998. p 12.01.
- Bergdoll MS. Staphylococcal intoxications. In: Riemann H, Bryan FL, eds. *Food-Borne Infections and Intoxications*. 2nd ed. New York: Academic Press, 1979, p. 443.
- Bergdoll MS. *Staphylococcus aureus*. In: Doyle MP, ed. *Foodborne Bacterial Pathogens*. New York: Marcel Dekker, 1989, p 463.
- Bergdoll MS, Sugiyama H, Dack GM. Staphylococcal enterotoxin. I. Purification. *Arch Biochem Biophys* 85:62, 1959.
- Besser RE, Lett SM, Weber JT, Doyle MP, Barrett TJ, Wells JG, Griffin PM. An outbreak of diarrhea and hemolytic uremic syndrome from *Escherichia coli* O157:H7 in fresh-pressed apple cider. *JAMA* 269:2217, 1993.

- Bezanson GS, Khakhria R, Duck D, Lior H. Molecular analysis confirms food source and simultaneous involvement of two distinct but related subgroups of *Salmonella typhimurium* bacteriophage type 10 in major interprovincial *Salmonella* outbreak. *Appl Environ Microbiol* 50:1279, 1985.
- Biberstein EL, Behymer DE, Bushnell R, Crenshaw G, Riemann HP, Franti CE. A survey of Q fever (*Coxiella burnetti*) in California dairy cows. *Am J Vet Res* 35:1577, 1974.
- Bigby M, Jick S, Arndt K. Drug-induced cutaneous lesion reactions. A report from the Boston Collaborative Drug Surveillance Program on 15,438 consecutive inpatients 1975–1982. *JAMA* 256:3358, 1986.
- Billon J, Guerin J, Sebald M. Studies on toxinogenesis of *Clostridium botulinum* type B during maturation of soft cheese. *Le Lait* 60:343, 1980.
- Birkhead G, Vogt RL, Heun E, Evelt CM, Patton CM. A multiple-strain outbreak of *Campylobacter* enteritis due to consumption of inadequately pasteurized milk. *J Infect Dis* 157:1095, 1988.
- Bishop JR, White CH. Antibiotic residue detection in milk—a review. *J Food Prot* 47: 647, 1984.
- Bishop JR, Senyk GF, Duncan SE, Case RA. Detection of antibiotic/drug residues in milk and dairy products. In: Marshall RT, ed. *Standard Methods for the Examination of Dairy Products*. 16th ed. Washington, DC: American Public Health Association, 1992, p 347.
- Black RE, Jackson RJ, Tsai T, Medvesky M, Shayegani M, Feeley JC, MacLeod KIE, Wakelee AM. Epidemic *Yersinia enterocolitica* infection due to contaminated chocolate milk. *N Engl J Med* 298:76, 1978.
- Blaser MJ. *Campylobacter* species. In: Mandell GL, Douglas RG, Bennet JE, eds. *Principles and Practice of Infectious Diseases*. New York: Churchill Livingstone, 1990, p 1649.
- Blaser MJ, Sazie E, Williams LP Jr. The influence of immunity on raw milk-associated *Campylobacter* infection. *JAMA* 257:43, 1987.
- Blaser MJ, Hardesty HL, Powers B, Wang W-LL. Survival of *Campylobacter fetus* subsp. *jejuni* in biological milieus. *J Clin Microbiol* 11:309, 1980.
- Blaser MJ, Cravens J, Powers BW, Laforce FM, Wang W-LL. *Campylobacter* enteritis associated with unpasteurized milk. *Am J Med* 67:715, 1979.
- Bleem A. *Escherichia coli* O157:H7 in raw milk—a review. In: *Animal Health Insight*, Spring/Summer 1994. Fort Collins, CO: USDA:APHIS:VS Centers for Epidemiology and Animal Health, 1994.
- Block RE, Levine MM, Clements ML, Hughes TP, Blaser MJ. Experimental *Campylobacter jejuni* infection in humans. *J Infect Dis* 157:142, 1988.
- Blouse J, Gengle LE, Lathrop GD, Hodder RA, Nowosiwski T, Caraway CT. A common-source outbreak of *Salmonella newport*—Louisiana. *Morbidity and Mortality Weekly Rep* 24:413, 1975.
- Bodnaruk PW, Williams RC, Golden DA. Survival of *Yersinia enterocolitica* during fermentation and storage of yoghurt. *J Food Sci* 63:535, 1998.
- Bone FJ, Bogie D, Morgan-Jones SC. Staphylococcal poisoning from sheep milk cheese. *Epidemiol Infect* 103:449, 1989.
- Boor KJ. Survival of *Escherichia coli* O157:H7 in fermented dairy products. Seattle, WA:

- Abstracts Annual Meeting of the International Association of Milk, Food, and Environmental Sanitarians, July 2, 1996.
- Borczyk AA, Karmali MA, Lior H, Duncan LMC. Bovine reservoir for verotoxin-producing *Escherichia coli* O157:H7. *Lancet* i:98, 1987.
- Bowen DA, Henning DR. Coliform bacteria and *Staphylococcus aureus* in retail natural cheeses. *J Food Prot* 57:253, 1994.
- Brackett RE, Marth EH. Association of aflatoxin M₁ with casein. *Z Lebensm Unters Forsch* 174:439, 1982a.
- Brackett RE, Marth EH. Fate of aflatoxin M₁ in cheddar cheese and in process cheese spread. *J Food Prot* 45:549, 1982b.
- Brackett RE, Marth EH. Fate of aflatoxin M₁ in Parmesan and mozzarella cheese. *J Food Prot* 45:597, 1982c.
- Bradbury WC, Pearson AD, Marko MA, Congi RV, Penner JL. Investigation of a *Campylobacter jejuni* outbreak by serotyping and chromosomal restriction endonuclease analysis. *J Clin Microbiol* 19:342, 1984.
- Brady MS, Katz SE. Antibiotic/antimicrobial residues in milk. *J Food Prot* 51:8, 1988.
- Bray J. Isolation of antigenically homogeneous strains of *Bact. coli neapolitanum* in summer diarrhea. *J Pathol Bacteriol* 57:239, 1945.
- Bray J, Beavan TED. Slide agglutination of *Bacterium coli* var. *neapolitanum* in summer diarrhea. *J Pathol Bacteriol* 60:395, 1948.
- Brieseman MA. Raw milk consumption as a probable cause of two outbreaks of *Campylobacter* infection. *N Z Med J* 97:411, 1984.
- Briozzo J, de Lagarde EM, Chirife J, Parada JL. *Clostridium botulinum* type A growth and toxin production in media and process cheese spread. *Appl Environ Microbiol* 45:1150, 1983.
- Brodsky MH. Evaluation of the bacteriological health risk of 60-day aged raw milk cheddar cheese. *J Food Prot* 47:530, 1984a.
- Brodsky MH. Bacteriological survey of freshly formed cheddar cheese. *J Food Prot* 47:546, 1984b.
- Brown EH, Bailey EH. Acute hemolytic anaemia in a case of infantile gastro-enteritis treated with oxytetracycline. *BMJ* 2:1204, 1958.
- Brown GL, Colwell DC, Hooper WL. An outbreak of Q fever in Staffordshire. *J Hyg Camb* 66:649, 1968.
- Bruce ME, Will RG, Ironside JW, McConnell I, Drummond D, Suttie A. Transmissions to mice indicate that "new variant" CJD is caused by the BSE agent. *Nature* 389:498, 1997.
- Bryan FL. Infections and intoxications caused by other bacteria. In: Riemann H, Bryan FL, eds. *Food-Borne Infections and Intoxications*. 2nd ed. New York: Academic Press, 1979, p 211.
- Bryan FL. Epidemiology of milk-borne disease. *J Food Prot* 46:637, 1983.
- Bryan FL, Fanelli MJ, Riemann H. *Salmonella* infections. In: Riemann H, Bryan FL, eds. *Food-borne Infections and Intoxications*. 2nd ed. New York: Academic Press, 1979, p. 73.
- Buazzi MM, Johnson ME, Marth EH. Fate of *Listeria monocytogenes* during the manufacture of mozzarella cheese. *J Food Prot* 55:80, 1992.
- Buchanan RL, Klawitter LA. The effect of incubation temperature, initial pH and sodium

- chloride on the growth kinetics of *Escherichia coli* O157:H7. *Food Microbiol* 9: 185, 1992.
- Buckner P, Ferguson D, Anzalone F, Anzalone D, Taylor J, Hlady WG, Hopkins RS. Outbreak of *Salmonella enteritidis* associated with homemade ice cream—Florida, 1993. *Morbidity and Mortality Weekly Report* 43:669, 1994.
- Bula CJ, Bille J, Glauser MP. An epidemic of food-borne listeriosis in western Switzerland: description of 57 cases involving adults. *Clin Infect Dis* 20:66, 1995.
- Bullerman LB. Examination of Swiss cheese for incidence of mycotoxin producing molds. *J Food Sci* 41:26, 1976.
- Bullerman LB, Olivigni FJ. Mycotoxin producing-potential of molds isolated from cheddar cheese. *J Food Sci* 39:1166, 1974.
- Campbell AG, Gibbard J. The survival of *E. typhosa* in cheddar cheese manufactured from infected raw milk. *Can J Public Health* 35:158, 1944.
- Candlish AAG, Stimson WH, Smith JE. A monoclonal antibody to aflatoxin B₁: detection of the mycotoxin by enzyme immunoassay. *Lett Appl Microbiol* 1:57, 1985.
- Capps JA, Miller JL. The Chicago epidemic of streptococcus sore throat and its relation to the milk supply. *JAMA* 58:1848, 1912.
- Casemore DP, Jessop EC, Douce D, Jackson FB. *Cryptosporidium* plus *Campylobacter*: an outbreak in a semi-rural population. *J Hyg Camb* 96:95, 1986.
- Castell Monsalve J, Rullan JV, Peiro Callizo EF, Nieto Sandoval Alcolea A, Monsalve JC, Callizo EFP, Alcolea ANS. Study of an epidemic of 81 cases of brucellosis after consumption of unpasteurized fresh cheese. *Rev Espanola Salud Pub* 70:303, 1996.
- Cato EP, George WL, Finegold SM. Genus *Clostridium*. In: Sneath PH, Mair NS, Sharpe ME, Holt JG, eds. *Bergey's Manual of Systematic Bacteriology*. Vol 2. Baltimore: Williams & Wilkins, 1986, p 1141.
- Caudill FW, Meyer MA. An epidemic of food poisoning due to pasteurized milk. *J Milk Technol* 6:73, 1943.
- Cerutti G, Campiglio A. Aflatoxins in foods: maximum permitted levels, with particular reference to milk and its derivatives. *Latte* 22:42, 1997.
- Charm SE, Zomer E, Salter R. Confirmation of widespread sulfonamide contamination in northeast U.S. milk market. *J Food Prot* 51:920, 1988.
- Cherif A, Benelmouffok A, Doudou A. Consumption of goat cheese and human brucellosis at Ghardaia (Algeria). *Arch Inst Pasteur Algerie* 55:9, 1986.
- Chiodini RJ, Hermon-Taylor J. The thermal resistance of *Mycobacterium paratuberculosis* in raw milk under conditions simulating pasteurization. *J Vet Diagn Invest* 5:629, 1993.
- Chiodini RJ, Kruijning HJV, Merkal RS. Ruminant paratuberculosis (Johne's disease): the current status and future prospects. *Cornell Vet* 74:218, 1984.
- Choi HK, Schaack MM, Marth EH. Survival of *Listeria monocytogenes* in cultured butter-milk and yogurt. *Milchwissenschaft* 43:790, 1988.
- Chopin A, Tesone S, Vila J-P, Le Graet Y, Mocquot G. Survie de *Staphylococcus aureus* au cours de la preparation et de la conservation de lait ecreme en poudre. Problemes poses par le denombrement des survivants. *Can J Microbiol* 24:1371, 1978.
- Christiansson A, Naidu AS, Nilsson I, Wadstrom T, Pettersson H-E. Toxin production by *Bacillus cereus* dairy isolates in milk at low temperatures. *Appl Environ Microbiol* 55:2595, 1989.

- Christie AB, Corbel MJ. Plague and other yersinia diseases. In: Smith GR, Easmon CSF, eds. Topley and Wilson's Principles of Bacteriology, Virology and Immunology. 8th ed. Vol 3—Bacterial Diseases. Philadelphia: BC Decker, 1990 p 399.
- Christopher FM, Smith GC, Vanderzant C. Effect of temperature and pH on the survival of *Campylobacter fetus*. J Food Prot 45:253, 1982.
- Clark WS, Nelson FE. Multiplication of coagulase-positive staphylococci in grade A raw milk samples. J Dairy Sci 44:232, 1961.
- Clover DO. Viral infections. In: Riemann H, Bryan FL, eds. Food-Borne Infections and Intoxications. 2nd ed. New York: Academic Press, 1979, p 299.
- Cohen J, Marambio E, Lynch B, Moreno A. *Bacillus cereus* food poisoning amid newborns. Rev Chilean Pediat 55:20, 1984.
- Cohen DR, Porter IA, Reid TMS, Sharp JCM, Forbes GI, Paterson GM. A cost benefit study of milk-borne salmonellosis. J Hyg Camb 91:17, 1983.
- Collee JG, Bradley R. BSE: a decade on, Part 2. Lancet 349:715, 1997.
- Collins CH, Grange JM. A review—the bovine tubercle bacillus. J Appl Bacteriol 55:13, 1983.
- Collins MT. *Mycobacterium paratuberculosis*: a potential foodborne pathogen? J Dairy Sci 80:3445, 1997.
- Collins P, Davies DC, Matthews PRJ. Mycobacterial infection in goats: diagnosis and pathogenicity of the organism. BVJ 140:196, 1984.
- Collins RN, Treger MD, Goldsby JB, Boring JR III, Coohon DB, Barr RN. Interstate outbreak of *Salmonella newbrunswick* infection traced to powdered milk. JAMA 203:838, 1968.
- Collins-Thompson DL, Wood DS, Thomson IQ. Detection of antibiotic residues in consumer milk supplies in North America using the Charm II test procedure. J Food Prot 51:632, 1988.
- Conner DE, Hall GS. Temperature and food additives affect growth and survival of *Escherichia coli* in poultry meat. Dairy Food Environ Sanitat 16:150, 1996.
- Conner DE, Kotrola JS. Growth and survival of *Escherichia coli* under acidic conditions. Appl Environ Microbiol 61:382, 1995.
- Conner DE, Scott VN, Bernard DT. Potential *Clostridium botulinum* hazards associated with extended shelf-life refrigerated foods: a review. J Food Safety 10:131, 1989.
- Cotter TP, Sheehan S, Cryan B, O'Shaughnessy E, Cumins H, Bredin CP. Tuberculosis due to *Mycobacterium bovis* in humans in the South-West region of Ireland: is there a relationship with infection prevalence in cattle? Tubercle Lung Dis 77:545, 1996.
- Cox WA. Problems associated with bacterial spores in heat-treated milk and milk products. J Soc Dairy Technol 28:59, 1975.
- Crielly EM, Logan NA, Anderton A. Studies on the *Bacillus* flora of milk and milk products. J Appl Bacteriol 77:256, 1994.
- Critchley EMR, Hayes PJ, Isaacs PET. Outbreak of botulism in northwest England and Wales, June, 1989. Lancet 2:849, 1989.
- Cullen JM, Ruebner BH, Hsieh DSP. Comparative hepatocarcinogenicity of aflatoxins B₁ and M₁ in the rat. Food Chem Toxicol 22:1027, 1985.
- Dack GM, Cary WE, Woolport WE, Wiggers H. Outbreak of food poisoning proved to be due to yellow hemolytic *Staphylococcus*. J Prevent Med 4:167, 1930.

- Dalrymple-Champneys W. *Brucella* Infection and Undulant Fever in Man. London: Oxford University Press, 1960.
- Dalton CB, Austin CC, Sobel J, Hayes PS, Bibb WF, Graves LM, Swaminathan B, Proctor ME, Griffin PM. An outbreak of gastroenteritis and fever due to *Listeria monocytogenes* in milk. *N Engl J Med* 336:100, 1997.
- D'Aoust J-Y. Infective dose of *Salmonella typhimurium* in cheddar cheese. *Am J Epidemiol* 122:717, 1985.
- D'Aoust J-Y. Manufacture of dairy products from unpasteurized milk: a safety assessment. *J Food Prot* 52:906, 1989.
- D'Aoust J-Y. *Salmonella* and the international food trade. *Int J Food Microbiol* 24:11, 1994.
- D'Aoust J-Y, Warburton DW, Sewell AM. *Salmonella typhimurium* phage-type 10 from cheddar cheese implicated in a major Canadian foodborne outbreak. *J Food Prot* 48:1062, 1985.
- D'Aoust J-Y, Park CE, Szabo RA, Todd ECD, Emmons DB, McKellar RC. Thermal inactivation of *Campylobacter* species, *Yersinia enterocolitica*, and hemorrhagic *Escherichia coli* O157:H7 in fluid milk. *J Dairy Sci* 71:3230, 1988.
- D'Aoust J-Y, Emmons DB, McKellar R, Timbers GE, Todd ECD, Sewell AM, Warburton DW. Thermal inactivation of *Salmonella* species in fluid milk. *J Food Prot* 50:494, 1987.
- Davey GM, Bruce J, Drysdale EM. Isolation of *Yersinia enterocolitica* and related species from the faeces of cows. *J Appl Bacteriol* 55:439, 1983.
- Davis J. The growth and viability of streptococci of bovine and human origin in milk and milk products. *J Infect Dis* 15:378, 1914.
- Day C, DeCov WR, Feffer D, Glosser J, Desonia B, Abbott B, Skinner M, Andersen JS. Salmonellosis associated with raw milk—Montana. *Morbidity and Mortality Weekly Report* 30:211, 1981.
- DeBoer E, Hartog BJ, Borst GHA. Milk as a source of *Campylobacter jejuni*. *Neth Milk Dairy J* 38:183, 1984.
- Decker MD, Lavelly GB, Hutcheson RH, Schaffner W. Food-borne streptococcal pharyngitis in a hospital pediatrics clinic. *JAMA* 253:679, 1985.
- DeGrace M, Laurin MF, Belanger C, Rolland PE, Blais R, Breton JP, Martineau G. *Yersinia enterocolitica* gastroenteritis outbreak—Montreal. *Can Dis Weekly Rep* 2: 41, 1976.
- Dekeyser P, Gossuin-Detrain M, Butzler JP, Sternon J. Acute enteritis due to related *Vibrio*: first positive stool cultures. *J Infect Dis* 125:390, 1972.
- DeMol P. Human campylobacteriosis: clinical and epidemiological aspects. *Dairy Food Environ Sanitat* 14:314–316, 1994.
- Desenclos JC, Bouvet P, Benz-Lemoine E, Grimont F, Desqueyroux H, Rebiere I, Grimont PA. Large outbreak of *Salmonella enterica paratyphi* B infection caused by a goats' milk cheese, France, 1993: a case finding and epidemiological study. *Br Med J Clin Res* 312:91, 1996.
- Desmaures N, Bazin F, Gueguen M. Microbiological composition of raw milk selected from farms in the Camembert region of Normandy. *J Appl Microbiol* 83:53, 1997.
- Diaz Cinco ME, Acedo F, Evelia LD, Alma B. Survival of *Brucella abortus* in the Mexican white cheese processing. *Dairy Food Environ Sanitat* 14:608, 1994.

- Diaz S, Moreno MA, Dominguez L, Suarez G, Blanco JL. Application of a diphasic dialysis technique to the extraction of aflatoxins in dairy products. *J Dairy Sci* 76:1845, 1993.
- Dineen SS, Takeuchi K, Soudah JE, Boor KJ. Persistence of *Escherichia coli* O157:H7 in dairy fermentation systems. *J Food Prot* 61:1602, 1998.
- Dixon JMS, Noble WC, Smith GR. Diphtheria: other corynebacterial and coryneform infections. In: Smith GR, Easmon CSF, eds. *Topley and Wilson's Principles of Bacteriology, Virology and Immunity*. 8th ed. Vol. 3—Bacterial Diseases. Philadelphia: BC Decker, 1990, p 55.
- Djuretic T, Wall PG, Nichols G. General outbreaks of infectious intestinal disease associated with milk and dairy products in England and Wales: 1992 to 1996. *Commun Dis Rep CDR Rev* 7:R41, 1997.
- Doeglas HMG, Huisman J, Nater JP. Histamine intoxication after cheese. *Lancet* 2:1361, 1967.
- Domagala J, Kiszka J, Bluthgren A, Heeschen W. Contamination of milk with aflatoxin M₁ in Poland. *Milchwissenschaft* 52:631, 1997.
- Dominguez LB, Relter A, Marks FJ, Press WB, Starko KM. *Salmonella* gastroenteritis associated with milk—Arizona. *Morbidity Mortality Weekly Rep* 28:117, 1979.
- Donnelly CB, Black LA, Lewis KH. Occurrence of coagulase-positive staphylococci in cheddar cheese. *Appl Microbiol* 12:311, 1964.
- Donta ST. Food poisoning. In: Braude AI, Davis CE, Fierer J, eds. *Infectious Diseases and Medical Microbiology*, 2nd ed. Philadelphia: WB Saunders, 1986, p 892.
- dos Reis Tassinari A, de Melo Franco BDG, Landgraf M. Incidence of *Yersinia* spp. in food in Sao Paulo, Brazil. *Int J Food Microbiol* 21:263, 1994.
- dos Santos EC, Genigeorgis C. Survival and growth of *Staphylococcus aureus* in commercially manufactured Brazilian Minas cheese. *J Food Prot* 44:177, 1981.
- dos Santos EC, Genigeorgis C, Farver TB. Prevalence of *Staphylococcus aureus* in raw and pasteurized milk used for commercial manufacturing of Brazilian Minas cheese. *J Food Prot* 44:172, 1981.
- Doyle MP. *Escherichia coli* O157:H7 and its significance in foods. *Int J Food Microbiol* 12:289, 1991.
- Doyle MP, Padhye NV. *Escherichia coli*. In: Doyle MP, ed. *Foodborne Bacterial Pathogens*. New York: Marcel Dekker, 1989, p 71.
- Doyle MP, Roman DJ. Prevalence and survival of *Campylobacter jejuni* in unpasteurized milk. *Appl Environ Microbiol* 44:1154, 1982a.
- Doyle MP, Roman DJ. Recovery of *Campylobacter jejuni* and *Campylobacter coli* from inoculated foods by selective enrichment. *Appl Environ Microbiol* 43:1343, 1982b.
- Doyle MP, Schoeni JL. Survival and growth characteristics of *Escherichia coli* associated with hemorrhagic colitis. *Appl Environ Microbiol* 48:855, 1984.
- Doyle MP, Glass KA, Berry JT, Garcia GA, Pollard DJ, Schultz RD. Survival of *Listeria monocytogenes* in milk during high-temperature, short-time pasteurization. *Appl Environ Microbiol* 53:1433, 1987.
- Dragacci S, Femy JM. Application of immunoaffinity column cleanup to aflatoxin M₁ determination and survey in cheese. *J Food Prot* 59:1011, 1996.
- Drobniewski FA. *Bacillus cereus* and related species. *Clin Microbiol Rev* 6:324, 1993.

- Duca E, Teodorovici G, Radu C, Vita A, Talasman-Niculescu P, Bernescu E, Feldi C, Rosca V. A new nephritogenic streptococci. *J Hyg Camb* 67:691, 1969.
- Dufrenne J, Bijwaard M, te Giffel M, Beumer R, Notermans S. Characteristics of some psychrotrophic *Bacillus cereus* isolates. *Intern J Food Microbiol* 27:175, 1995.
- DuPont HL, Formal SB, Hornick RB, Synder MJ, Libonati JP, Sheahan DG, LaBrec EH, Kalas JP. Pathogenesis of *Escherichia coli* diarrhea. *N Engl J Med* 285:1, 1971.
- Echeverria P, Taylor DN, Bettelheim KA, Chatkaeomorakot A, Changchawalit S, Thongcharoen A, Leksomboon U. HeLa cell-adherent enteropathogenic *Escherichia coli* in children under 1 year of age in Thailand. *J Clin Microbiol* 25:1472, 1987.
- Eckman MR. Brucellosis linked to Mexican cheese. *JAMA* 232:636, 1975.
- Eckner KF, Zottola EA. The behavior of selected microorganisms during manufacture of high moisture Jack cheeses from ultrafiltered milk. *J Dairy Sci* 74:2820, 1991.
- Eckner KF, Dustman WA, Rys-Rodriguez AA. Contribution of composition, physico-chemical characteristics and polyphosphates to the microbial safety of pasteurized cheese spreads. *J Food Prot* 57:295, 1994.
- Eckner KF, Roberts RF, Strantz AA, Zottola EA. Characterization and behavior of *Salmonella javiana* during manufacture of mozzarella-type cheese. *J Food Prot* 53:461, 1990.
- Edelman R, Levine MM. From the National Institute of Allergy and Infectious Diseases—Summary of a workshop on enteropathogenic *Escherichia coli*. *J Infect Dis* 147:1108, 1983.
- Edwards AT, Roulson M, Ironside MJ. A milk-borne outbreak of serious infection due to *Streptococcus zooepidemicus* (Lancefield Group C). *Epidem Infect* 101:43, 1988.
- Edwards PR, West MG, Bruner DW. Antigenic studies of a group of paracolonic bacteria (Bethesda group). *J Bacteriol* 55:711, 1948.
- Edwards ST, Sandine WE. Public health significance of amines in cheese. *J Dairy Sci* 64:2431, 1981.
- Ehlers JG, Chapparo-Serrano M, Richter RL, Vanderzant C. Survival of *Campylobacter fetus* subsp. *jejuni* in cheddar and cottage cheese. *J Food Prot* 45:1018, 1982.
- El-Dairouty KF. Staphylococcal intoxication traced to non-fat dried milk. *J Food Prot* 12:901, 1989.
- El-Gazzar FE, Marth EH. Salmonellae, salmonellosis, and dairy foods: a review. *J Dairy Sci* 75:2327, 1992.
- Ellis A, Preston M, Borczyk A, Miller B, Stone P, Hatton B, Chagla A, Hockin J. A community outbreak of *Salmonella* Berta associated with a soft cheese product. *Epidem Infect* 120:29, 1998.
- El-Refai A-MH, Sallam LAR, Naim N. The alkaloids of fungi. I. The formation of ergoline alkaloids by representative mold fungi. *Jpn J Microbiol* 14:91, 1970.
- Elsner KAA, Moricz M, Procter EM. *Cryptosporidium* infections: a laboratory survey. *Can Med Assoc J* 135:211, 1986.
- Engel G, Teuber M. Toxic metabolites from fungal cheese starter cultures (*Penicillium camemberti* and *Penicillium roqueforti*). In: van Egmond HP, ed. *Mycotoxins in Dairy Products*. London: Elsevier Applied Science, 1989, p 163.
- Erkmen O. Behavior of *Staphylococcus aureus* in Turkish Feta cheese during manufacture and ripening. *J Food Prot* 58:1201, 1995.

- Erkmen O, Bozoglu TF. Behaviour of *Salmonella typhimurium* in feta cheese during manufacture and ripening. *Food Sci Technol* 32:480, 1995.
- Erksine D. Dermatitis caused by penicillin in milk. *Lancet* 1:431, 1958.
- Espinosa FH, Ryan WM, Vigil PL, Gregory DF, Hilley RB, Romig DA, Stamm RB, Suhre ED, Taulbee PS, Zucal LH, Honsinger RW Jr, Lindberg PJ, Barcheck M, Miller JA, Mitzelfelt R, Montes JM, Nims LJ, Rollag OJ, Weber N, Mann JM. Group C streptococcal infections associated with eating homemade cheese—New Mexico. *Morbidity and Mortality Weekly Report* 32:510, 1983.
- Evans AD. "Q" fever in South Wales. *Mon Bull Minist Health* 21:215, 1956.
- Evans DA, Litsky W. Thermal inactivation studies on certain pathogenic organisms in milk. *Bacteriol Proc* 19:10, 1968.
- Evans MR, Roberts RJ, Riberio CD, Gardner D, Kembrey D. A milk-borne *Campylobacter* outbreak following an educational farm visit. *Epidem Infect* 117:457, 1996.
- Evenson ML, Hinds MW, Bernstein RS, Bergdoll MS. Estimation of human dose of staphylococcal enterotoxin A from a large outbreak of staphylococcal food poisoning involving chocolate milk. *Int J Food Microbiol* 7:311, 1988.
- Eyler JM. The epidemiology of milk-borne scarlet fever: the case of Edwardian Brighton. *Am J Public Health* 76:573, 1986.
- Fakuuzi FR, Zyambo GCN, Morris SD. A serological survey of bovine brucellosis in the Melopo District of Bophuthatswana. *J South Afr Vet Assoc* 64:154, 1993.
- Fanning J. An unusual outbreak of gastroenteritis. *BMJ* 1:583, 1935.
- Fantasia LD, Mestrandrea L, Schrade JP, Yager J. Detection and growth of enteropathogenic *Escherichia coli* in soft ripened cheese. *Appl Microbiol* 29:179, 1975.
- Farber JM, Peterkin PI. *Listeria monocytogenes*, a food-borne pathogen. *Microbiol Rev* 55:476, 1991.
- Farber JM, Sanders GW, Speirs JI. Growth of *Listeria monocytogenes* in naturally-contaminated raw milk. *Lebensm Wiss Technol* 23:252, 1990.
- Farkhondeh A, Ghazvinian R, Lavhal Ph. Contamination par les *Salmonella* du fromage iranien frais, non sale, mis en vente dans la region de Teheran. *Le Lait* 535/536:302, 1974.
- Farrag SA, Marth EH. *Escherichia coli* O157:H7, *Yersinia enterocolitica* and their control in milk by the lactoperoxidase system: a review. *Lebensm Wiss Technol* 25:201, 1992.
- Federighi M, Magras C, Pilet MF, Woodward D, Johnson W, Jugiau F, Jouve JL. Incidence of thermotolerant *Campylobacter* in foods assessed by NF ISO 10272 standard: results of a two-year study. *Food Microbiol* 16:195, 1999.
- Felip G, Toti L. Foodborne diseases caused by gram-negative microorganisms in milk products. *Microbiol Aliments Nutr* 2:251, 1984.
- Feng P. Appendix 1-Rapid methods for detecting foodborne pathogens In: *FDA Bacteriological Analytical Manual*. 8th ed., AOAC International, Gaithersburg, MD, 1998.
- Finch MJ, Blake PA. Foodborne outbreaks of campylobacteriosis: the United States experience, 1980–1982. *Am J Epidemiol* 122:262, 1985.
- Fishbein DB, Raoult D. A cluster of *Coxiella burnetii* infections associated with exposure to vaccinated goats and their unpasteurized dairy products. *Am J Trop Med Hyg* 47:35, 1992.
- Fleming DW, Cochi SL, MacDonald KL, Brondum J, Hayes PS, Plikaytis BD, Homes

- MB, Audurier A, Broome CV, Reingold AL. Pasteurized milk as vehicle of infection in an outbreak of listeriosis. *N Engl J Med* 312:404, 1985.
- Flowers RS, Andrews W, Donnelly CW, Koenig E. Pathogens in milk and milk products. In: Marshall RT, ed. *Standard Methods for the Examination of Dairy Products*. 16th ed. Washington, DC: American Public Health Association, 1992, p 103.
- Flowers RS, D'Aoust J-Y, Andrews WH, Bailey JS. *Salmonella*. In: Vanderzant C, Splitsoesser DF, eds. *Compendium of Methods for the Microbiological Examination of Foods*, 3rd ed. Washington, DC: American Public Health Association, 1992b, p 371.
- Foley AR, Poisson E. A cheese-borne outbreak of typhoid fever. *Can J Public Health* 36: 116, 1945.
- Foley BV, Clay MM, O'Sullivan DJ. A study of a brucellosis epidemic. *Irish J Med Sci* 3:457, 1970.
- Fontaine RE, Cohen ML, Martin WT, Vernon TM. Epidemic salmonellosis from cheddar cheese—surveillance and prevention. *Am J Epidemiol* 111:247, 1980.
- Food Surveillance Information Sheet. Survey of aflatoxin M₁ in farm gate milk-UK Ministry of Agriculture, Fisheries and Food, Food Safety Directorate, HMSO Publications Center, London, no. 78, 1996.
- FoodNet. CDC/FSIS/FDA Foodborne Diseases Active Surveillance Network—CDC's Emerging Infections Program 1998 Surveillance Results Preliminary Report. <http://www.cdc.gov/ncidod/dbmd/foodnet/98surv.htm>.
- Franciosa G, Pourshaban M, Gianfranceschi M, Gattuso A, Fencia L, Ferrini AM, Mannoni V, DeLuca G, Aureli P. *Clostridium botulinum* spores and toxin in Mascarpone cheese and other milk products. *J Food Prot* 62:867, 1999.
- Francis AJ, Nimmo GR, Efstratiou A, Galanis V, Nuttall N. Investigation of milk-borne *Streptococcus zooepidemicus* infection associated glomerulonephritis in Australia. *J Infect* 27:317, 1993.
- Francis BJ, Allard J. *Salmonella typhimurium*—Yakima County, Washington. *Morbidity Mortal Weekly Rep* 16:178, 1967.
- Francis BJ, Davis JP. Update: gastrointestinal illness associated with imported semi-soft cheese. *Morbidity Mortal Weekly Rep* 33:16, 1984.
- Francis BJ, Langkop C, Mitchel H, Donnell HD Jr, Hernandez C, Telle RD, Halpin TJ. Presumed staphylococcal food poisoning associated with whipped butter. *Morbidity Mortal Weekly Rep* 26:268, 1977.
- Francis DW, Spaulding PL, Lovett J. Enterotoxin production and thermal resistance of *Yersinia enterocolitica* in milk. *Appl Environ Microbiol* 40:174, 1980.
- Frank JF, Marth EH. Inhibition of enteropathogenic *Escherichia coli* by homofermentative lactic acid bacteria in milk—I. Comparison of strains of *Escherichia coli*. *J Food Prot* 40:749, 1977a.
- Frank JF, Marth EH. Inhibition of enteropathogenic *Escherichia coli* by homofermentative lactic acid bacteria in milk—II. Comparison of lactic acid bacteria and enumeration methods. *J Food Prot* 40:754, 1977b.
- Frank JF, Marth EH. Survey of soft and semisoft cheese for presence of fecal coliforms and serotypes of enteropathogenic *Escherichia coli*. *J Food Prot* 41:198, 1978.
- Frank JF, Marth EH, Olson NF. Survival of enteropathogenic and non-enteropathogenic

- Escherichia coli* during the manufacture of Camembert cheese. J Food Prot 40:835, 1977.
- Frank JF, Marth EH, Olson NF. Behavior of enteropathogenic *Escherichia coli* during manufacture and ripening of brick cheese. J Food Prot 41:111, 1978.
- Fremy JM, Chu FS. Direct ELISA for determining AFM₁ at picogram levels in dairy products. JAOAC 67:1098, 1984.
- Fremy JM, Chu FS. Immunochemical methods of analysis for aflatoxin M₁. In: van Egmond HP, ed. Mycotoxins in Dairy Products. London: Elsevier Applied Science, 1989, p 97.
- Frobish RA, Bradley BD, Wagner DD, Long-Bradley PE, Hairston H. Aflatoxin residues in milk of dairy cows after ingestion of naturally contaminated grain. J Food Prot 49:781, 1986.
- Fulton JS. Contagious abortion of cattle and undulant fever in man. Med Officer 65:201, 1941.
- Galbraith NS, Forbes P, Clifford C. Communicable disease associated with milk and dairy products in England and Wales 1951–1980. BMJ 284:1761, 1982.
- Galbraith NS, Ross MS, de Mowbray RR, Payne DJH. Outbreak of *Brucella melitensis* type 2 infection in London. BMJ 1:612, 1969.
- Galvano F, Galofaro V, De Angelis A, Galvano M, Bognanno M, Galvano G. Survey of the occurrence of aflatoxin M₁ in dairy products marketed in Italy. J Food Prot 61:738, 1998.
- Garcia ML, Moreno B, Bergdoll MS. Characterization of staphylococci isolated from mastitic cows in Spain. Appl Environ Microbiol 39:548, 1980.
- Gauthier J, Foley AR. A cheese-borne outbreak of typhoid fever. Can J Public Health 34:543, 1943.
- Geiger JC, Crowley AB, Gray JP. Food poisoning from ice cream on ships. JAMA 105:1980, 1935.
- Gelletlie R, Stuart J, Soltanpoor N, Armstrong R, Nichols G. Cryptosporidiosis associated with school milk. Lancet 350:1005, 1997.
- George JTA, Wallace JG, Morrison HR, Harbourne JF. Paratyphoid in man and cattle. BMJ 3:208, 1972.
- Ghoneim A, Cooke EM. Serious infection caused by group C streptococci. J Clin Pathol 33:188, 1980.
- Giffel MC, Beumer RR. Isolation, identification and characterization of *Bacillus cereus* from the dairy environment. Tijdschrift Diergeneeskunde 123:628, 1998.
- Giffel MC, Beumer RR, Graanum PE, Rombouts FM. Isolation and characterization of *Bacillus cereus* from pasteurized milk in household refrigerators in the Netherlands. Intern J Food Microbiol 34:307, 1996.
- Gilbert GL, Davoren RA, Cole ME. Mid-trimester abortion associated with septicaemia caused by *Campylobacter jejuni*. Med J Aust 1:585, 1981.
- Gilbert RJ. *Bacillus cereus* gastroenteritis. In: Riemann H, Bryan FL, eds. Foodborne Infections and Intoxications. 2nd ed. New York: Academic Press, 1979, p 495.
- Gilbert RJ, Parry JM. Serotypes of *Bacillus cereus* from outbreaks of food poisoning and from routine foods. J Hyg Camb 78:69, 1977.
- Gill KPW, Bates PG, Lander KP. The effect of pasteurization on the survival of *Campylobacter* species in milk. BVJ 137:578, 1981.

- Gilles G, Jouglard J, Sebald M, Jacquet MJ. Sur une epidemie de botulisme humain enquete et hypotheses etiologiques: role possible du fromage et des paillons. *Rec Med Vet* 47:165, 1974.
- Gilman HL, Dahlberg AC, Marquardt JC. The occurrence and survival of *Brucella abortus* in cheddar and Limburger cheese. *J Dairy Sci* 29:71, 1946.
- Glass KA, Kaufman KM, Smith AL, Johnson EA, Chen JH, Hotchkiss J. Toxin production by *Clostridium botulinum* in pasteurized milk treated with carbon dioxide. *J Food Prot* 62:872, 1999.
- Glatz BA, Brudvig SA. Survey of commercially available cheese for enterotoxigenic *Escherichia coli*. *J Food Prot* 43:395, 1980.
- Goepfert JM, Olson NF, Marth EH. Behavior of *Salmonella typhimurium* during manufacture and curing of cheddar cheese. *Appl Microbiol* 16:862, 1968.
- Goepfert JM, Spira WM, Kim HU. *Bacillus cereus*: food poisoning organism. A review. *J Milk Food Technol* 35:213, 1972.
- Gogov Y, Slavchev G, Peeva T. Cold resistance of *S. aureus* and A and C₂ staphylococcus enterotoxins in ice cream. *Vet Sci (Sofia)* 21:46, 1984.
- Golden DA, Hou JJ. Survival of *Yersinia enterocolitica* during manufacture and storage of short- and long-set cottage cheese (abstr). New Orleans, LA: Annual Meeting of the Institute of Food Technologists. June 22–25, 1996.
- Goldie W, Maddock ECG. A milk-borne outbreak of diphtheria. *Lancet* 1:285, 1943.
- Goldwater PN, Bettelheim KA. Hemolytic uremic syndrome due to Shiga-like toxin producing *Escherichia coli* O48:H21 in South Australia. *Emerg Infect Dis* 1:132, 1995.
- Gomez-Lucia E, Blanco JL, Goyache J, de La Fuente R, Vazquez JA, Ferri EFR, Suarez G. Growth and enterotoxin A production by *Staphylococcus aureus* S6 in Manchego-type cheese. *J Appl Bacteriol* 61:499, 1986.
- Gomez-Lucia E, Goyache J, Orden JA, Domenech A, Hernandez FJ, Quiteria JAR-S, Lopez B, Blanco JL, Suarez G. Growth of *Staphylococcus aureus* and synthesis of enterotoxin during ripening of experimental Manchego-type cheese. *J Dairy Sci* 75: 19, 1992.
- Goulet V, Jacquet C, Vaillant V, Rebiere I, Mouret E, Lorente C, Maillot E, Stainer F, Rocourt J. Listeriosis from consumption of raw-milk cheese. *Lancet* 345:1581, 1995.
- Graadl O, Nygaard K. Crohn's disease: long term effects of surgical treatment. *Tidssk Norske Laegeforen* 114:1603, 1994.
- Grange JM. Tuberculosis. In: Smith GR, Easmon CSF, eds. *Topley and Wilson's Principles of Bacteriology, Virology and Immunity*. 8th ed. Vol. 3—Bacterial Diseases. Philadelphia: BC Decker, 1990, p 55.
- Grant IR, Ball HJ, Neill SD, Rowe MT. Inactivation of *Mycobacterium paratuberculosis* in cows' milk at pasteurization temperatures. *Appl Environ Microbiol* 62:631, 1996.
- Granum PE, Brynestad S, Kramer JM. Analysis of enterotoxin production by *Bacillus cereus* from dairy products, food poisoning incidents and non-gastrointestinal infections. *Intern J Food Microbiol* 17:269, 1993.
- Gray LD. *Escherichia*, *Salmonella*, *Shigella* and *Yersinia*. In: Murray PR, Baron EJ, Pfaller MA, Tenover FC, Tenover RH, eds. *Manual of Clinical Microbiology*. 6th ed. Washington, DC: ASM Press, 1995, p 450.

- Gray ML, Killinger AH. *Listeria monocytogenes* and listeric infections. *Bacteriol Rev* 30: 309, 1966.
- Grecz N, Wagenaar RO, Dack GM. Storage stability of *Clostridium botulinum* toxin and spores in processed cheese. *Appl Microbiol* 13:1014, 1965.
- Greenwood MH, Hooper WL. Excretion of *Yersinia* spp. associated with consumption of pasteurized milk. *Epidemiol Infect* 104:345, 1990.
- Greenwood MH, Hooper WL, Rodhouse JC. The source of *Yersinia* spp. in pasteurized milk: an investigation at a dairy. *Epidemiol Infect* 104:351, 1990.
- Gresikova M, Sekeyova M, Stupalova S, Necas S. Sheep milk-borne epidemic of tick-borne encephalitis in Slovakia. *Interviol* 5:57, 1975.
- Griffin PM, Tauxe RV. The epidemiology of infections caused by *Escherichia coli* O157:H7, other enterohemorrhagic *E. coli* and the associated hemolytic uremic syndrome. *Epidemiol Rev* 13:60, 1991.
- Griffin PM, Ostroff SM, Tauxe RV, Greene KD, Wells JG, Lewis JH, Blake PA. Illness associated with *Escherichia coli* O157:H7 infections. *Ann Intern Med* 109:705, 1988.
- Griffith AS. Human tubercle bacilli in the milk of a vaccinated cow. *J Pathol Bacteriol* 17:323, 1913.
- Griffiths MW. Toxin production by psychrotrophic *Bacillus* spp. present in milk. *J Food Prot* 53:790, 1990.
- Griffiths MW, Phillips JD. Incidence, source and some properties of psychrotrophic *Bacillus* found in raw and pasteurized milk. *J Soc Dairy Technol* 43:62, 1990.
- Gross EM, Weizman Z, Picard E, Mates A, Sheinman R, Platzner N, Wolff A. Milkborne gastroenteritis due to *Staphylococcus aureus* enterotoxin B from a goat with mastitis. *Am J Trop Med Hyg* 39:103, 1988.
- Guitierrez LM, Menes I, Garcia ML, Moreno B, Bergdoll MS. Characterization and enterotoxigenicity of staphylococci isolated from mastitic ovine milk in Spain. *J Food Prot* 45:1282, 1982.
- Gunzer F, Bohm H, Russman H, Bitzan M, Aleksic S, Karch H. Molecular detection of sorbitol fermenting *Escherichia coli* O157 in patients with hemolytic uremic syndrome. *J Clin Microbiol* 30:1807, 1992.
- Gyles CL. *Escherichia coli* cytotoxins and enterotoxins. *Can J Microbiol* 38:734, 1992.
- Habib N, Warring FC. A fatal case of infection due to *Mycobacterium bovis*. *Am Rev Respir Dis* 93:804, 1966.
- Hackler JF. Outbreak of *Staphylococcus* milk poisoning in pasteurized milk. *Am J Public Health* 29:1247, 1939.
- Halpin-Dohnalek MI, Marth EH. Fate of *Staphylococcus aureus* in whey, whey cream, and whey cream butter. *J Dairy Sci* 72:3149, 1989a.
- Halpin-Dohnalek MI, Marth EH. Growth and production of enterotoxin A by *Staphylococcus aureus* in cream. *J Dairy Sci* 72:2266, 1989b.
- Halpin-Dohnalek MI, Marth EH. Growth of *Staphylococcus aureus* in milks and creams with various amounts of milk fat. *J Food Prot* 52:540, 1989c.
- Hamama A, El Marrakchi A, El Othmani F. Occurrence of *Yersinia enterocolitica* in milk and dairy products in Morocco. *Int J Food Microbiol* 16:69, 1992.
- Hammer BW. *Dairy Bacteriology*. 2nd ed. New York: John Wiley & Sons, 1938, p 150.

- Hancock DD, Besser TE, Kinsel ML, Tarr PI, Rice DH, Paros MG. The prevalence of *Escherichia coli* O157:H7 in dairy and beef cattle in Washington State. *Epidemiol Infect* 113:199, 1994.
- Hanna MO, Stewart JC, Carpenter ZL, Vanderzant C. Heat resistance of *Yersinia enterocolitica* in skim milk. *J Food Prot* 40:689, 1977.
- Hargrove RE, McDonough FE, Mattingly WA. Factors affecting survival of *Salmonella* in cheddar and Colby cheese. *J Milk Food Technol* 32:480, 1969.
- Harmon SM, Goepfert JM, Bennett RW. *Bacillus cereus*. In: Marshall RT, ed. *Standard Methods for the Examination of Dairy Products*. Washington, DC: Am Public Health Assoc. 1992, p 593.
- Harp JA, Fayer R, Pesch BA, Jackson GJ. Effect of pasteurization on infectivity of *Cryptosporidium parvum* oocysts in water and milk. *Appl Environ Microbiol* 62:2866, 1996.
- Harris NV, Kimball T, Weiss NS, Nolan C. Dairy products and other non-meat foods as possible sources of *Campylobacter jejuni* and *Campylobacter coli* enteritis. *J Food Prot* 49:347, 1986.
- Harris NV, Kimball TJ, Bennett P, Johnson Y, Wakely D, Nolan CM. *Campylobacter jejuni* enteritis associated with raw goat's milk. *Am J Epidemiol* 126:179, 1987.
- Hart RJC. *Corynebacterium ulcerans* in humans and cattle in North Devon. *J Hyg Camb* 92:161, 1984.
- Hauge S. Food poisoning due to *Bacillus cereus*: a preliminary report. *Nord Hyg Tigskr* 31:189, 1950.
- Hauge S. Food poisoning caused by aerobic sporeforming bacteria. *J Appl Bacteriol* 18: 591, 1955.
- Hauschild AHW. *Clostridium botulinum*. In: Doyle MP, ed. *Foodborne Bacterial Pathogens*. New York: Marcel Dekker, 1989, p 111.
- Headrick ML, Korangy S, Bean NH, Klontz KC, Angulo FJ, Altekruze SF, Potter ME. Epidemiology of Milk-Associated Foodborne Disease Outbreaks Reported in the United States, 1973–1993. *The Continued Risk of Raw Milk Consumption*. Atlanta, GA: Centers for Disease Control and Prevention, 1996.
- Headrick ML, Timbo B, Klontz KC, Werner SB. Profile of raw milk consumers in California. *Pub Health Rep* 112:418, 1997.
- Headrick ML, Korangy S, Bean N, Angulo FJ, Alterkruse SF, Potter ME, Klontz C. The epidemiology of raw milk-associated foodborne disease outbreaks reported in the United States, 1973 through 1992. *Am J Pub Health* 88:1219, 1998.
- Hedberg CW, Koralath JA, D'Acoust J-Y, White KE, Schell WL, Miller MR, Cameron DN, MacDonald KL, Osterholm MT. A multistate outbreak of *Salmonella javiana* and *Salmonella oranienburg* infections due to consumption of contaminated cheese. *JAMA* 268:3203, 1992.
- Helmy ZA, Abd-el-Malek Y, Mahmoud AA. Growth of *Staphylococcus aureus*, experimentally inoculated in Damietta cheese. *Zbl Bakteriell Abt II*, 130:468, 1975.
- Hendricks SL, Meyer ME. Brucellosis. In: Hubbert WT, McCulloch WF, Schurrenburger PR, eds. *Diseases Transmitted from Animals to Man*. 6th ed. Springfield, IL: Charles C Thomas, 1975, p 10.
- Hendricks SL, Belknap RA, Hausler WJ Jr. Staphylococcal food intoxication due to cheddar cheese. I. Epidemiology. *J Milk Food Technol* 22:313, 1959.

- Hennessy TW, Hedberg CW, Slutsker L, White KE, Besset-Wiek JM, Moen ME, Feldman J, Coleman WW, Edmonson LM, MacDonald KL, Osterholm MT, the Investigation Team. A national outbreak of *Salmonella enteritidis* infections from ice cream. *N Engl J Med* 334:1281, 1996.
- Henry JE. Milk-borne diphtheria. An outbreak traced to infection of a milk handler's finger with *B. diphtheriae*. *JAMA* 75:1715, 1920.
- Heuvelink AE, Bleumink B, van den Biggelaar FLAM, te Giffel MC, Beumer RR, de Boer E. Occurrence and survival of verocytotoxin-producing *Escherichia coli* O157 in raw cow's milk in the Netherlands. *J Food Prot* 61:1597, 1998.
- Hill WE, Datta AR, Feng P, Lampel KA, Payne WL. Identification of foodborne bacterial pathogens by gene probes. In: FDA Bacteriological Analytical Manual. 8th ed. Gaithersburg, MD: AOAC International, 1995, p 24.01.
- Hinz PC, Slatter WL, Harper WJ. A survey of various free amino and fatty acids in domestic Swiss cheese. *J Dairy Sci* 39:235, 1956.
- Hirschmann SZ. Viral hepatitis. In: Braude AI, Davis CE, Fierer J, eds. Infectious Diseases and Medical Microbiology. 2nd ed. Philadelphia: WB Saunders, 1986, p 989.
- Hitchins AD. *Listeria monocytogenes*. Identification of foodborne bacterial pathogens by gene probes. In: FDA Bacteriological Analytical Manual. 8th ed. Gaithersburg, MD: AOAC International, 1998, p 10.01.
- Hitchins AD, Feng P, Watkins WD, Rippey SR, Chandler LA. *Escherichia coli* and the coliform bacteria. In: FDA Bacteriological Analytical Manual. 8th ed. Gaithersburg, MD: AOAC International, 1998, p 4.01.
- Hobbs BC. The clostridia. In: Braude AI, Davis CE, Fierer J, eds. Infectious Diseases and Medical Microbiology. 2nd ed. Philadelphia: WB Saunders, 1986, p 407.
- Holmberg SD, Blake PA. Staphylococcal food poisoning in the United States: new facts and old misconceptions. *JAMA* 251:487, 1984.
- Holmes JR, Plunkett T, Pate P, Roper WL, Alexander WJ. Emetic food poisoning caused by *Bacillus cereus*. *Arch Intern Med* 141:766, 1981.
- Horning BG. Outbreak of undulant fever due to *Brucella suis*. *JAMA* 24:1978, 1935.
- Hosek G, Leschinsky D, Irons S, Safranek TJ. Multidrug-resistant *Salmonella* serotype Typhimurium—United States, 1996. *Morbidity and Mortality Weekly Report* 46:308, 1996.
- Horvath G, Toth-Martón E, Meszaros JM, Quarini L. Experimental *Bacillus cereus* mastitis in cows. *Acta Vet Hung* 34:29, 1986.
- Hudson LM, Chen J, Hill AR, Griffiths MW. Bioluminescence: a rapid indicator of *Escherichia coli* O157:H7 in selected yogurt and cheese varieties. *J Food Prot* 60:891, 1997.
- Hudson PJ, Vogt RL, Brondum J, Patton CM. Isolation of *Campylobacter jejuni* from milk during an outbreak of campylobacteriosis. *J Infect Dis* 150:789, 1984.
- Hudson SJ, Sobo AO, Russel K, Lightfoot NF. Jackdaws as potential source of milk-borne *Campylobacter jejuni* infection. *Lancet* 336:1160, 1990.
- Huebner RJ, Bell JA. "Q" fever studies in southern California—summary of current results and a discussion of possible control measures. *JAMA* 145:301, 1951.
- Huebner RJ, Jellison WL, Beck MD, Wilcox FP. Q fever studies in southern California—effects of pasteurization on survival of *C. burnetii* in naturally infected milk. *Public Health Report* 64:499, 1949.

- Hughes D, Jensen N. *Yersinia enterocolitica* in raw goat's milk. *Appl Environ Microbiol* 41:309, 1981.
- Hui JY, Taylor SL. Inhibition of in vivo histamine metabolism in rats by foodborne and pharmacologic inhibitors of diamine oxidase, histamine N-methyl transferase, and monoamine oxidase. *Toxicol Appl Pharmacol* 8:241, 1985.
- Humphrey TJ, Hart RJC. *Campylobacter* and *Salmonella* contamination of unpasteurized cow's milk on sale to the public. *J Appl Bacteriol* 65:463, 1988.
- Hunt J, Abeyta C, Tran C. *Campylobacter*. In: FDA Bacteriological Analytical Manual. 8th ed. Gaithersburg, MD: AOAC International, 1998, p 7.01.
- Hunt JM, Francis DW, Peeler JT, Lovett J. Comparison of methods for isolating *Campylobacter jejuni* from raw milk. *Appl Environ Microbiol* 50:535, 1985.
- Hutchinson DN, Bolton FJ, Jelley WCN, Mathews WG, Telford DR, Counter DE, Jessop EG, Horsley SD. *Campylobacter* enteritis associated with consumption of raw goat's milk. *Lancet* 1:1037, 1985a.
- Hutchinson DN, Bolton FJ, Hinchliffe PM, Dawkins HC, Horsley SD, Jessop EG, Robertshaw PA, Counter DE. Evidence of udder excretion of *Campylobacter jejuni* as the cause of a milk-borne *Campylobacter* outbreak. *J Hyg Camb* 94:205, 1985b.
- Ibrahim GF, Radford DR, Baldock AK, Ireland LB. Inhibition of growth of *Staphylococcus aureus* and enterotoxin-A production in cheddar cheese produced by induced starter failure. *J Food Prot* 44:189, 1981a.
- Ibrahim GF, Radford DR, Baldock AK, Ireland LB. Inhibition of *Staphylococcus aureus* growth and enterotoxin-A production in cheddar cheese produced with variable starter activity. *J Food Prot* 44:263, 1981b.
- Ikram M, Luedecke LO. Growth and enterotoxin A production by *Staphylococcus aureus* in fluid dairy products. *J Food Prot* 40:769, 1977.
- James T. The story of the enteropathogenic *Escherichia coli*. *S Afr Med J* 47:1476, 1973.
- Jaquette CB, Beuchat LR. Combined effects of pH, nisin, and temperature on growth and survival of psychrotrophic *Bacillus cereus*. *J Food Prot* 61:563, 1998.
- Jeżyna Cz, Weglińska T, Nawrocka E, Falecka W, Wieliczko-gebska L, Rodkiewicz T, Piesiak Z, Ciesielski T. A milk-borne outbreak of tick-borne encephalitis in the Olsztyn Province. *Przeg Epidemiol* 30:480, 1976.
- Jokipii L, Jokipii AMM. Cryptosporidiosis. In: Braude AI, Davis CE, Fierer J, eds. *Infectious Disease and Medical Microbiology*. 2nd ed. Philadelphia: WB Saunders 1986, p 931.
- Jones EE, Kim-Farley RJ, Algunaid M, Parvez MA, Ballard YA, Hightower AW, Orenstein WA, Broome CV. Diphtheria: a possible foodborne outbreak in Hodeida, Yemen Arab Republic. *Bull WHO* 63:287, 1985.
- Jones GA, Gibson DL, Cheng K-J. Coliform bacteria in Canadian pasteurized dairy products. *Can J Public Health* 58:257, 1967.
- Jones PH, Willis AT, Robinson DA, Skirrow MB, Josephs DS. *Campylobacter* enteritis associated with the consumption of free school milk. *J Hyg Camb* 87:155, 1981.
- Jones TO. Caprine mastitis associated with *Yersinia pseudotuberculosis* infection. *Vet Rec* 110:231, 1982.
- Kahana LM, Todd E. Histamine intoxication in a tuberculosis patient on isoniazid. *Can Dis Weekly Rep* 7:79, 1981.

- Kaneene JB, Ahl AS. Drug residues in dairy cattle industry: epidemiological evaluation of factors influencing their occurrence. *J Dairy Sci* 70:2176, 1987.
- Kaneene JB, Miller R. Description and evaluation of the influence of veterinary presence on the use of antibiotics and sulfonamides in dairy herds. *J Am Vet Med Assoc* 201:68, 1992.
- Kantor HS. Bacterial enteritis. In: Braude AI, Davis CE, Fierer J, eds. *Infectious Diseases and Medical Microbiology*. 2nd ed. Philadelphia: WB Saunders, 1986, p 897.
- Karahadian C, Lindsay RC, Dillman LL, Deibel RH. Evaluation of the potential for botulinal toxigenesis in reduced-sodium processed American cheese foods and spreads. *J Food Prot* 48:63, 1985.
- Karmali MA, Steele BT, Petric M, Lim C. Sporadic cases of haemolytic uremic syndrome associated with faecal cytotoxin and cytotoxin-producing *Escherichia coli* in stools. *Lancet* 1:619, 1983.
- Kasatiya SS. *Yersinia enterocolitica* gastroenteritis outbreak—Montreal. *Can Dis Weekly Rep* 2:73, 1976.
- Kasrazadeh M, Genigeorgis C. Potential growth and control of *Salmonella* in Hispanic type soft cheese. *Int J Food Microbiol* 22:127, 1994.
- Kasrazadeh M, Genigeorgis C. Potential growth and control of *Escherichia coli* O157:H7 in soft Hispanic type cheese. *Int J Food Microbiol* 25:289, 1995.
- Kästli P, Hausch R. The viability of *Br. abortus* in different cheese varieties. *Schweiz Arch Tierheilk* 99:638, 1957.
- Kauf C, Lorent JP, Mosimann J, Schlatter I, Somaini B, Velvart J. Botulismusepidemie vom Typ B. *Schweiz med Wschr* 104:677, 1974.
- Kaufmann OW, Brillaud AR. Development of *Clostridium botulinum* in experimentally inoculated sterile skim milk held at low temperatures. *Am J Public Health* 54:1514, 1964.
- Kauppi KL, Tatini SR, Harrell F, Feng P. Influence of substrate and low temperature on growth and survival of verotoxigenic *Escherichia coli*. *Food Microbiol* 13:397, 1996.
- Kautter DA, Lilly T Jr, Lynt RK, Solomon HM. Toxin production by *Clostridium botulinum* in shelf-stable pasteurized process cheese spreads. *J Food Prot* 42:784, 1979.
- Kautter DA, Solomon HM, Lake DE, Bernard DT, Mills DC. *Clostridium botulinum* and its toxins. In: Murray PR, Baron EJ, Pfaller MA, Tenover FC, Tenover RH, eds. *Manual of Clinical Microbiology*. 6th ed. Washington, DC: ASM Press, 1992, p 605.
- Kells HR, Lear SA. Thermal death time curve of *Mycobacterium tuberculosis* var. *bovis* in artificially infected milk. *Appl Microbiol* 8:234, 1960.
- Keswani J, Frank JF. Thermal inactivation of *Mycobacterium paratuberculosis* in milk. *J Food Prot* 61:974, 1998.
- Khalid AS, Harrigan WF. Investigation into the effect of salt level on growth of, and toxin production by, *Staphylococcus aureus* in Sudanese cheese. *Lebensm Wiss Technol* 17:99, 1984.
- Khambaty FM, Bennett RW, Shah DB. Application of pulsed-field gel electrophoresis to the epidemiological characterization of *Staphylococcus intermedius* implicated in a food-related outbreak. *Epidemiol Infect* 113:75, 1994.

- Khayat FA, Bruhn JC, Richardson GH. A survey of coliforms and *Staphylococcus aureus* in cheese using impedimetric and plate count methods. *J Food Prot* 51:53, 1988.
- Kiermeier F, Buchner M. Distribution of aflatoxin M₁ in whey and curd during cheese processing. *Z Lebensm Unters Forsch* 164:82, 1977.
- Kiermeier F, Weiss G, Behringer G, Miller M, Ranfft K. Presence and content of aflatoxin M₁ in milk supplied to a dairy. *Z Lebensm Unters Forsch* 163:71, 1977.
- King NB. The survival of *Brucella abortus* (USDA strain 2308) in manure. *J Am Vet Med Assoc* 31:349, 1957.
- Kleeburg HH. Tuberculosis and other mycobacteriosis. In: Hubbert WT, McCulloch WF, Schnurrenberger PR, eds. *Diseases Transmitted from Animals to Man*. 6th ed. Springfield, IL: Charles C Thomas, 1975, p 315.
- Klein BS, Vergeront JM, Blaser MJ, Edmonds P, Brenner DJ, Janssen D, Davis JP. *Campylobacter* infection associated with raw milk—an outbreak of gastroenteritis due to *Campylobacter jejuni* and thermotolerant *Campylobacter fetus* subsp. *fetus*. *JAMA* 255:361, 1986.
- Kloos WE, Bannerman TL. *Staphylococcus* and *Micrococcus*. In: Murray PR, Baron EJ, Pfaller MA, Tenover FC, Tenover RH, eds. *Manual of Clinical Microbiology*. 6th ed. Washington, DC: ASM Press, 1995, p 282.
- Kloos WE, Schliefer KH. Genus IV *Staphylococcus*. In: Sneath PH, Mair NS, Sharpe ME, Holt JG, eds. *Bergey's Manual of Systematic Bacteriology*. Vol 2. Baltimore: Williams & Wilkins, 1986, p 1013.
- Knight P. Hemorrhagic *E. coli*: the danger increases—disease outbreaks and several deaths from contaminated meat products have officials scrambling to change out-moded rules. *ASM News*, 59:247, 1993.
- Koenig S, Marth EH. Behavior of *Staphylococcus aureus* in cheddar cheese made with sodium chloride or a mixture of sodium chloride and potassium chloride. *J Food Prot* 45:996, 1982.
- Kohl I, Kozuch O, Eleckova, E, Labuda M, Zaludko J. Family outbreak of alimentary tick-borne encephalitis in Slovakia associated with a natural focus of infection. *Eur J Epidemiol* 12:373, 1996.
- Koidis P, Doyle MP. Procedure for recovery of *Campylobacter jejuni* from inoculated unpasteurized milk. *Appl Environ Microbiol* 47:455, 1984.
- Konowalchuk J, Speirs JJ, Stavric S. Vero response to a cytotoxin in *Escherichia coli*. *Infect Immunol* 18:775, 1977.
- Korlath JA, Osterholm MT, Judy LA, Forfang JC, Robinson RA. A point-source outbreak of campylobacteriosis associated with consumption of raw milk. *J Infect Dis* 152: 592, 1985.
- Kornacki JL, Marth EH. Fate of nonpathogenic and enteropathogenic *Escherichia coli* during the manufacture of Colby-like cheese. *J Food Prot* 45:310, 1982.
- Kornblatt AN, Barrett T, Morris GK, Tosh FE. Epidemiologic and laboratory investigation of an outbreak of *Campylobacter* enteritis associated with raw milk. *Am J Epidemiol* 122:884, 1985.
- Kramer JM, Gilbert RJ. *Bacillus cereus* and other *Bacillus* species. In: Doyle MP, ed. *Foodborne Bacterial Pathogens*. New York: Marcel Dekker, 1989, p 22.
- Kristuffkova Z, Simkovicova M. Epidemic of enterotoxigenesis from ice cream caused by staphylococcal TSST-1. *Czech Epidem Mikrobiol Imunol* 37:36, 1988.

- Krumbiegel ER, Wisniewski HJ. Q fever in the Milwaukee area. II. Consumption of infected raw milk by human volunteers. *Arch Environ Health* 21:63, 1970.
- Kuesch GT. Typhoid fever. In: Braude AI, Davis CE, Fierer C, eds. *Infectious Diseases and Medical Microbiology*. 2nd ed. Philadelphia: WB Saunders, 1986, p 1189.
- Kuzdas CD, Morse EV. The survival of *Brucella abortus*, USDA strain 2308, under controlled conditions in nature. *Cornell Vet* 44:216, 1954.
- Lancette GA, Tatini SR. *Staphylococcus aureus*. In: Vanderzant C, Splittstoesser DF, eds. *Compendium of Methods for the Microbiological Examination of Foods*. Washington, DC: American Public Health Association, 1992, p 533.
- Lander KP, Gill KPW. Experimental infection of the bovine udder with *Campylobacter coli/jejuni*. *J Hyg Camb* 84:421, 1980.
- Langeveld LPM, van Spronsen WA, van Beresteijn CH, Notermans SHW. Consumption by healthy adults of pasteurized milk with a high concentration of *Bacillus cereus*: a double blind study. *J Food Prot* 59:723, 1996.
- Larsen HD, Jorgensen K. The occurrence of *Bacillus cereus* in Danish pasteurized milk. *Intern J Food Microbiol* 34:179, 1996.
- Lecos CW. A closer look at dairy safety. *Dairy Food Environ Sanitat* 6:240, 1986.
- Lee RY, Silverman GJ, Munsey DT. Growth and enterotoxin A production by *Staphylococcus aureus* in precooked bacon in the intermediate moisture range. *J Food Sci* 46:1687, 1981.
- Lennette EH, Clark WH, Abinanti MA, Brunetti O, Covert JM. Q fever studies—effect of pasteurization on *Coxiella burnetii* in naturally infected milk. *Am J Hyg* 55:246, 1952.
- Levine MM. *Escherichia coli* that cause diarrhea: enterotoxigenic, enteropathogenic, enteroinvasive, enterohemorrhagic, and enteroadherent. *J Infect Dis* 155:377, 1987.
- Levine MM, Caplan ES, Waterman D, Cash RA, Hornick RB, Snyder MJ. Diarrhea caused by *Escherichia coli* that produce only heat stable enterotoxin. *Infect Immun* 17:78, 1977.
- Levy AJ. A gastro-enteritis outbreak probably due to a bovine strain of *Vibrio*. *Yale J Biol Med* 20:243, 1947.
- Levy ME. Gastrointestinal illness associated with imported Brie cheese—District of Columbia. *Morbidity Mortal Weekly Rep* 32:533, 1983.
- LiCari JJ, Potter NN. *Salmonella* survival during spray drying and subsequent handling of skim milk powder. II. Effects of drying conditions. *J Dairy Sci* 52:871, 1970a.
- LiCari JJ, Potter NN. *Salmonella* survival during spray drying and subsequent handling of skim milk powder. III. Effects of storage temperature on *Salmonella* and dried milk products. *J Dairy Sci* 53:877, 1970b.
- Lin S, Schraft H, Odumeru JA, Griffiths MW. Identification of contamination sources of *Bacillus cereus* in pasteurized milk. *Intern J Food Microbiol* 43:159, 1998.
- Linnan MJ, Mascola L, Lou XD, Goulet V, May S, Salminen C, Hird DW, Yonkura ML, Hayes P, Weaver R, Audurier A, Plikaytis BD, Fannin SL, Kleks A, Broome CV. Epidemic listeriosis associated with Mexican-style cheese. *N Engl J Med* 319:823, 1988.
- Lior H. *Campylobacters*—epidemiological markers. *Dairy Food Environ Sanitat* 14:317, 1994a.

- Lior H. *Escherichia coli* O157:H7 and verotoxigenic *Escherichia coli* (VTEC). Dairy Food Environ Sanitat 14:378, 1994b.
- Little CL, Knochel S. Growth and survival of *Yersinia enterocolitica*, *Salmonella* and *Bacillus cereus* in Brie stored at 4, 8 and 20°C. Int J Food Microbiol 24:137, 1994.
- Logan EF, Neill SD, Mackie DP. Mastitis in dairy cows associated with an aerotolerant campylobacter. Vet Rec 110:229, 1982.
- Logan NA. *Bacillus* species of medical and veterinary importance. J Med Microbiol 25: 157, 1988.
- Lopes HR, Solino Noleto AR, de Las Heras MD, Bergdoll MS. Selective enterotoxin production in foods by *Staphylococcus aureus* strains that produce more than one enterotoxin. J Food Prot 56:538, 1993.
- Lopez-Diaz TM, Roman-Blanco C, Garcia-Arias MT, Garcia-Fernandez MC, Garcia-Lopez ML. Mycotoxins in two Spanish cheese varieties. Intern J Food Microbiol 30:391, 1996.
- Lovett J, Francis DW, Hunt JM. Isolation of *Campylobacter jejuni* from raw milk. Appl Environ Microbiol 46:459, 1983.
- Lovett J, Bradshaw JG, Peeler JT. Thermal inactivation of *Yersinia enterocolitica* in milk. Appl Environ Microbiol 44:517, 1982.
- Lumsden LL, Leahe JP, Crohurst HR, Waller CE. The Montreal typhoid fever situation—report of a special board of the U.S. Public Health Service. Am J Public Health 17:783, 1927.
- MacDonald KL, Eidson M, Strohmeier C, Levy ME, Wells JG, Puhr ND, Wachsmuth K, Hargett NT, Cohen ML. A multistate outbreak of gastrointestinal illness caused by enterotoxigenic *Escherichia coli* in imported semisoft cheese. J Infect Dis 151: 716, 1985.
- MacDonald KL, Griffin PM. Food-borne disease outbreaks, annual summary, 1982. Morbid Mortal Weekly Rep 35:7ss, 1983.
- MacDonald KL, Griffin PM. Foodborne disease outbreaks, annual summary, 1982. Morbid Mortal Weekly Rep 35(SS-1):7SS, 1986.
- MacLachlan J. Salmonellosis in Midlothian and Peeblesshire. Public Health Lond 88:79, 1974.
- Maguire H. Continuing hazards from unpasteurized milk products in England and Wales. Int Food Safety News 2(2):22, 1993.
- Maguire H, Cowden J, Jacob M, Rowe B, Roberts D, Bruce J, Mitchell E. An outbreak of *Salmonella dublin* infection in England and Wales associated with a soft unpasteurized cow's milk cheese. Epidemiol Infect 109:389, 1992.
- Maguire HCF, Boyle M, Lewis MJ, Pankhurst J, Wieneke AA, Jacob M, Bruce J, O'Mahony M. A large outbreak of food poisoning of unknown aetiology associated with Stilton cheese. Epidemiol Infect 106:497, 1991.
- Mantis A, Koidis P, Karaioannoglou P. Survival of *Yersinia enterocolitica* in yogurt. Milchwissenschaft 37:654, 1982.
- Marier R, Wells JG, Swanson RC, Callahan W, Mehlman IJ. An outbreak of enteropathogenic *Escherichia coli* foodborne disease traced to imported French cheese. Lancet 2:1376, 1973.
- Markaki P, Melissari E. Occurrence of aflatoxin M₁ in commercial pasteurized milk determined with ELISA and HPLC. Food Add Contam 14:451, 1997.

- Marth EH. Salmonellae and salmonellosis associated with milk and milk products: a review. *J Dairy Sci* 52:283, 1969.
- Martin ML, Shipman LD, Wells JG, Potter ME, Hedberg K, Wachsmuth IK, Tauxe RV, Davis JP, Arnoldi J, Tilleli J. Isolation of *Escherichia coli* O157:H7 from dairy cattle associated with two cases of haemolytic uremic syndrome. *Lancet* 2:1043, 1986.
- Massa S, Poda G, Cesaroni D, Trovatelli LD. A bacteriological survey of retail ice cream. *Food Microbiol* 6:129, 1989.
- Massa S, Altieri C, Quaranta V, Pace R. Survival of *Escherichia coli* O157:H7 in yogurt during preparation and storage at 4°C. *Lett Appl Microbiol* 24:347, 1997.
- Massa S, Goffredo E, Altieri C, Natola K. Fate of *Escherichia coli* O157:H7 in unpasteurized milk stored at 8°C. *Lett Appl Microbiol* 28:89, 1999.
- Matches JR, Liston J. Low temperature growth of *Salmonella*. *J Food Sci* 33:641, 1968.
- Matuszczyk I, Tarnowska H, Zabicka J, Gut W. An outbreak of milky epidemic of encephalitis caused by tick-borne encephalitis virus in Kielce Province. *Prezglad Epidemiol* 51:381, 1997.
- McCleery DR, Rowe MT. Development of a selective plating technique for recovery of *Escherichia coli* O157:H7 after heat stress. *Lett Appl Microbiol* 21:252, 1995.
- McCloskey RV. Diphtheria. In: Braude AI, Davis CE, Fierer J, eds. *Infectious Diseases and Medical Microbiology*, Philadelphia: WB Saunders, p 718, 1986.
- McDonough FE, Hargrove RE, Tittsler RP. The fate of salmonellae in the manufacture of cottage cheese. *J Milk Food Technol* 30:354, 1967.
- McEwen SA, Martin SW, Clarke RC, Tamblyn SE. A prevalence survey of *Salmonella* in raw milk in Ontario, 1986–1987. *J Food Prot* 51:963, 1988.
- McKhann GM, Cornblath DR, Griffin JW, Ho TW, Li CY, Jiang Z, Wu HS, Zhaori G, Liu Y, Jou LP, Liu TC, Gao CY, Mao JY, Blaser MJ, Mishu B, Asbury AK. Acute motor axonal neuropathy: a frequent cause of acute flaccid paralysis in China. *Ann Neurol* 33:333, 1993.
- McKinnon CH, Pettipher GL. A survey of sources of heat-resistant bacteria in milk with particular reference to psychrotrophic spore-forming bacteria. *J Dairy Res* 50:163, 1983.
- McLauchlin JM, Greenwood H, Pini PN. The occurrence of *Listeria monocytogenes* in cheese from a manufacturer associated with a case of listeriosis. *Int J Food Microbiol* 3/4:255, 1990.
- McManus C, Lanier JM. *Salmonella*, *Campylobacter jejuni*, and *Yersinia enterocolitica* in raw milk. *J Food Prot* 50:51, 1987.
- McNaughton RD, Leyland R, Mueller L. Outbreak of *Campylobacter* enteritis due to consumption of raw milk. *Can Med Assoc J* 126:657, 1982.
- Mead PS, Slutsker L, Dietz V, McCaig LF, Bresee JS, Shapiro C, Griffin PM, Tauxe RV. Food-related illness and death in the United States. *Emerg Infect Dis* 5:607, 1999.
- Meers PD. A case of classical diphtheria and other infections due to *Corynebacterium ulcerans*. *J Infect* 1:139, 1979.
- Melling J, Capel BJ, Turnbull PCB, Gilbert RJ. Identification of a novel enterotoxigenic activity associated with *Bacillus cereus*. *J Clin Pathol* 29:938, 1976.
- Menzies DB. An outbreak of typhoid fever in Alberta traceable to infected cheddar cheese. *Can J Public Health* 35:431, 1944.

- Metwally MM, El-Sayed AMAA, Mehriz AM, Abu-Sree YH. Sterigmatocystin—incidence, fate and production by *A. versicolor* in Ras cheese. *Mycotoxin Res* 13:61, 1997.
- Meyer KF, Eddie B. Perspectives concerning botulism. *Z Hyg Infektionskr* 133:255, 1951.
- Meyrand A, Boutrand-Loei S, Ray-Gueniot S, Mazuy C, Gaspard CE, Jaubert G, Perrin G, Lapeyre C, Vernozzy-Rozand C. Growth and enterotoxin production of *Staphylococcus aureus* during the manufacture and ripening of Camembert-type cheeses from raw goats' milk. *J Appl Microbiol* 85:537, 1998.
- Mickelson R, Foltz VD, Martin WH, Hunter CA. The incidence of potentially pathogenic staphylococci in dairy products at the consumer level. II. Cheese. *J Milk Food Technol* 24:342, 1962.
- Mikolajcik EM, Kearney JW, Kristoffersen T. Fate of *Bacillus cereus* in cultured and direct acidified skim milk and cheddar cheese. *J Milk Food Technol* 36:317, 1973.
- Millar D, Ford J, Sanderson J, Withey S, Tizard M, Doran T, Herman Taylor J. IS900 PCR to detect *Mycobacterium paratuberculosis* in retail supplies of whole pasteurized cow's milk in England and Wales. *Appl Environ Microbiol* 62:3446, 1996.
- Minor TE, Marth EH. *Staphylococcus aureus* and enterotoxin A in cream and butter. *J Dairy Sci* 55:1410, 1972.
- Mishu B, Blaser MJ. Role of infection due to *Campylobacter jejuni* in the initiation of Guillain-Barré syndrome. *Clin Infect Dis* 17:104, 1993.
- Mitscherlich E, Marth EH. Microbial Survival in the Environment—Bacteria and Rickettsiae Important in Human and Animal Health. Berlin: Springer-Verlag, 1984.
- Moats WA. Inactivation of antibiotics by heating in foods and other substrates—a review. *J Food Prot* 51:491, 1988.
- Mohammad A, Peiris JSM, Wijewanta EA. Serotypes of verocytotoxigenic *Escherichia coli* isolated from cattle and buffalo calf diarrhea. *FEMS Microbiol Lett* 35:261, 1986.
- Montenegro MA, Bulte M, Trumpf T, Aleksic S, Reuter G, Bulling E, Helmuth R. Detection and characterization of fecal verotoxin-producing *Escherichia coli* from healthy cattle. *J Clin Microbiol* 28:1417, 1990.
- Moore K, Damrow T, Abott DO, Jankowski S. Outbreak of acute gastroenteritis attributable to *Escherichia coli* serotype O104:H21—Helena, Montana, 1994. *JAMA* 274:529, 1995.
- Morgan D, Gunneberg C, Gunnell D, Healing TD, Lamerton S, Soltanpoor N, Lewis DA, White DG. An outbreak of *Campylobacter* infection associated with consumption of unpasteurized milk at a large festival in England. *Eur J Epidemiol* 10:581, 1994b.
- Morgan D, Mawer SL, Harman PL. The role of home-made ice cream as a vehicle of *Salmonella enteritidis* phage type 4 infection from fresh shell eggs. *Epidemiol Infect* 113:21, 1994a.
- Morgan D, Newman CP, Hutchinson DN, Walker AM, Rowe B, Majid F. Verotoxin producing *Escherichia coli* O157 infections associated with consumption of yoghurt. *Epidemiol Infect* 111:181, 1993.
- Mor-Mur M, Carretero C, Pla R, Guamis B. A survey on the microbiological quality of a semi-soft on-farm manufactured goat cheese. *Food Microbiol* 9:345, 1992.
- Moustafa MK, Ahmed AA-H, Marth EH. Behavior of virulent *Yersinia enterocolitica* during manufacture and storage of Colby-like cheese. *J Food Prot* 46:318, 1983a.

- Moustafa MK, Ahmed AA-H, Marth EH. Occurrence of *Yersinia enterocolitica* in raw and pasteurized milk. *J Food Prot* 46:276, 1983b.
- Moyer NP, Holcomb LA. *Brucella*. In: Murray PR, Baron EJ, Pfaller MA, Tenover FC, Tenover FC, eds. *Manual of Clinical Microbiology*. 6th ed. Washington, DC:ASM Press, 1995, p 549.
- Murray EGD, Webb RA, Swann MBR. A disease of rabbits characterized by a large mononuclear leucocytosis caused by a hitherto undescribed bacillus *Bacterium monocytogenes* (n. sp.). *J Pathol Bacteriol* 29:407, 1926.
- Nachamkin I. *Campylobacter* and *Arcobacter*. In: Murray PR, Baron EJ, Pfaller MA, Tenover FC, Tenover FC, eds. *Manual of Clinical Microbiology*. 6th ed. Washington, DC: ASM Press, 1995, p 483.
- Naguib MN, Nour MA, Noaman AA. Survival of *Staphylococcus aureus* in Ras cheese. *Arch Lebensmittelhyg* 30:197, 1979.
- Neill MA. *E. coli* O157:H7—current concepts and future prospects. *J Food Safety* 10: 99, 1989.
- Nevin M. Botulism from cheese. *J Infect Dis* 28:226, 1921.
- Nolan CM, Anderson HW, Hoyt DET. *Salmonella* surveillance pays off. *Epilog* July/August 1981. Seattle, WA: Seattle King County Department of Public Health, 1981.
- Nolte FS, Metchock B. *Mycobacterium*. In: Murray PR, Baron EJ, Pfaller MA, Tenover FC, Tenover FC, eds. *Manual of Clinical Microbiology*. 6th ed. Washington, DC: ASM Press, 1995, p 400.
- Northolt MD, Beckers HJ, Vecht U, Toepoel L, Soentoro PSS, Wisselink HJ. *Listeria monocytogenes*: heat resistance and behavior during storage of milk and whey and making of Dutch types of cheese. *Neth Milk Dairy J* 42:207, 1988.
- Notermans S, Hoogenboom-Verdegaal A. Existing and emerging foodborne diseases. *Int J Food Microbiol* 15:197, 1992.
- Nour MA. Survival of *Brucella* organisms in artificially contaminated cream. *Egypt J Food Sci* 10:67, 1982.
- Nunez M, Chavarri FJ, Garcia BE, Gaytan LE. The effect of lactic starter inoculation and storage temperature on the behavior of *Staphylococcus aureus* and *Enterobacter cloacae* in Burgos cheese. *Food Microbiol* 3:235, 1986.
- Obiger G von, Neuschulz J, Schonberg A. Tests made on French cream cheese for possible exciters of brucellosis and tuberculosis. *Ber Münch tierärz. Wochenschr* 16:318, 1970.
- Ocando AJF, Gutierrez DU, Apalmo ZR, Salas LTC, Basanta Y. Microflora isolated from Venezuelan “Palmita-type” cheese. *J Food Prot* 54:856, 1991.
- Odumeru JA, Toner AK, Muckle CA, Griffiths MW, Lynch JA. Detection of *Bacillus cereus* diarrheal enterotoxin in raw and pasteurized milk. *J Food Prot* 60:1391, 1997.
- Oliver SP, Maki JL, Dowlen HH. Antibiotic residues in milk following antimicrobial therapy during lactation. *J Food Prot* 53:693, 1990.
- Olsen JA, Yousef AE, Marth EH. Growth and survival of *Listeria monocytogenes* during making and storage of butter. *Milchwissenschaft* 43:487, 1988.
- Olsen SJ, MacKinon CL, Goulding JS, Bean NH, Slutsker L. Surveillance for Food-borne Disease Outbreaks—United States, 1993–1997. *Morbidity and Mortality Weekly Report* 49(SS01):1, 2000.

- Olson JC Jr, Sanders AC. Penicillin in milk and milk products: some regulatory and public health considerations. *J Milk Food Technol* 38:630, 1975.
- Olson JC Jr, Casman EP, Baer EF, Stone JE. Enterotoxigenicity of *Staphylococcus aureus* cultures isolated from acute cases of bovine mastitis. *Appl Microbiol* 20:605, 1970.
- Olsvik O, Kapperud G. Enterotoxin production in milk at 22 and 4°C by *Escherichia coli* and *Yersinia enterocolitica*. *Appl Environ Microbiol* 43:997, 1982.
- O'Mahony M, Mitchell E, Gilbert RJ, Hutchinson DN, Begg NT, Roadhouse JC, Morris JE. An outbreak of foodborne botulism associated with contaminated hazelnut yogurt. *Epidemiol Infect* 104:389, 1990.
- Ordonez AI, Ibanez FC, Toore P, Barcina Y. Formation of biogenic amines in Idiazabal ewe's milk cheese: effect of ripening, pasteurization and starter. *J Food Prot* 60:1371, 1997.
- Orskov F, Orskov I. *Escherichia coli* serotyping and disease in man and animals. *Can J Microbiol* 38:699, 1992.
- Osterholm MT, MacDonald KL, White KE, Wells JG, Spika JS, Potter ME, Forfang JC, Sorenson RM, Milloy PT, Blake PA. An outbreak of a newly recognized chronic diarrhea syndrome associated with raw milk consumption. *JAMA* 256:484, 1986.
- Otero A, Garcia MC, Garcia ML, Prieto M, Moreno B. Behavior of *Staphylococcus aureus* strains, producers of enterotoxins C₁ or C₂ during the manufacture and storage of Burgos cheese. *J Appl Microbiol* 64:117, 1988.
- Overcast WW, Atmaram K. The role of *Bacillus cereus* in sweet curdling of fluid milk. *J Milk Food Technol* 37:233, 1974.
- Padhye NV, Doyle MP. Rapid procedure for detecting enterohemorrhagic *Escherichia coli* O157:H7 in food. *Appl Environ Microbiol* 57:2693, 1991.
- Padhye NV, Doyle MP. *Escherichia coli* O157:H7 epidemiology, pathogenesis and methods for detection in food. *J Food Prot* 55:555, 1992.
- Paiba GA, Green LE, Lloyd G, Patel D, Morgan KL. Prevalence of antibodies to *Coxiella burnetii* (Q fever) in bulk tank milk in England and Wales. *Vet Rec* 144:519, 1999.
- Papadopoulou C, Maipa V, Dimitriou D, Pappas C, Voutsinas L, Malatou H. Behavior of *Salmonella enteritidis* during the manufacture, ripening, and storage of feta cheese made from unpasteurized ewe's milk. *J Food Prot* 56:25, 1993.
- Papageorgiou DK, Marth EH. Fate of *Listeria monocytogenes* during the manufacture and ripening of blue cheese. *J Food Prot* 52:459, 1989a.
- Papageorgiou DK, Marth EH. Fate of *Listeria monocytogenes* during the manufacture, ripening and storage of feta cheese. *J Food Prot* 52:82, 1989b.
- Park, HS and Marth EH. Behavior of *Salmonella typhimurium* in skimmilk during fermentation by lactic acid bacteria. *J Milk Food Technol* 35:482, 1972a.
- Park HS, Marth EH. Growth of salmonellae in skimmilk which contains antibiotics. *J Milk Food Technol* 35:7, 1972b.
- Park HS, Marth EH, Goepfert JM, Olson NF. The fate of *Salmonella typhimurium* in the manufacture and ripening of low-acid cheddar cheese. *J Milk Food Technol* 33:280, 1970a.
- Park HS, Marth EH, Olson NF. Survival of *Salmonella typhimurium* in cold-pack cheese food during refrigerated storage. *J Milk Food Technol* 33:383, 1970b.
- Park K-Y, Bullerman LB. Increased aflatoxin production by *Aspergillus parasiticus* under conditions of cycling temperature. *J Food Sci* 46:1147, 1981.

- Park K-Y, Bullerman LB. Effects of substrate and temperature on aflatoxin production by *Aspergillus parasiticus* and *Aspergillus flavus*. *J Food Prot* 46:178, 1983.
- Park WH, Krumwiede C Jr. The relative importance of the bovine and human types of tubercle bacilli in the different forms of human tuberculosis. *J Med Res* 25:313, 1911.
- Parker F, Hudson NP. The etiology of Haverhill fever (erythema arthriticum epidemicum). *Am J Pathol* ii:357, 1926.
- Parker MT. Enteric infections: typhoid and paratyphoid fever. In: Smith GR, Easmon CSF, eds. Topley and Wilson's Principles of Bacteriology, Virology and Immunity. 8th ed. Vol 3—Bacterial Diseases. Philadelphia: BC Decker, 1990, p 423.
- Parry WH. Milk-borne diseases: an epidemiological review. *Lancet* i:216, 1966.
- Passes H, Glasser D, Flynn J, Acree KH. Bovine tuberculosis—Maryland. *Morbidity Mortality Weekly Rep* 27:108, 1978.
- Patterson DSP, Glancy EM, Roberts BA. The carry-over of aflatoxin M₁ into the milk of cows fed rations containing a low concentration of aflatoxin B₁. *Food Cosmet Toxicol* 18:35, 1980.
- Patterson WJ, Painter MJ. Bovine spongiform encephalopathy and new variant Creutzfeldt-Jakob disease: an overview. *Comm Dis Pub Health* 2:5, 1999.
- Pattison J. The emergence of bovine spongiform encephalopathy and related diseases. *Emerg Infect Dis* 4:390, 1998.
- Patton CM, Wachsmuth IK, Evins GM, Kiehlbauch JA, Plikaytis BD, Troup N, Tompkins L, Lior H. Evaluation of 10 methods to distinguish epidemic-associated *Campylobacter* strains. *J Clin Microbiol* 29:680, 1991.
- Pereira ML, Do Carmo LS, Dos Santos EJ, Pereira JL, Bergdoll MS. Enterotoxin H in staphylococcal food poisoning. *J Food Prot* 59:559, 1996.
- Pfeiffer DH, Viljoen NF. Diphtheria and mastitis. *J South Afr Vet Med Assoc* 16:148, 1945.
- Phillips JD, Griffiths MW. Factors contributing to the seasonal variation of *Bacillus* spp. in pasteurized dairy products. *J Appl Bacteriol* 61:275, 1986.
- Pietri A, Bertuzzi T, Bertuzzi P, Piva G. Aflatoxin M₁ occurs in samples of Grana padano cheese. *Food Add Contam* 14:341, 1997.
- Pinegar JA, Buxton JD. An investigation of the bacteriological quality of retail vanilla slices. *J Hyg Camb* 78:387, 1977.
- Pirttijarvi TSM, Ahonen LM, Maunuksela LM, Salkinoja-Salonen MS. *Bacillus cereus* in a whey process. *Intern J Food Microbiol* 44:31, 1998.
- Place AR. Animal drug residues in milk—the problem and the response. *Dairy Food Environ Sanitat* 10:662, 1990.
- Polewska-Jeske A, Szulc M, Waluszkiewicz H. An epidemic of alimentary poisoning with ice cream in Szczecin caused by *Salmonella typhimurium*. *Przeg Epidemiol* 38:61, 1984.
- Pong RS, Wogan GN. Toxicity and biochemical and fine structural effects of synthetic aflatoxins M₁ and B₁ in rat liver. *J Nat Cancer Inst* 47:585, 1971.
- Porter AMW, Smith EL. Brucellosis and goat's cheese? *BMJ* 3:580, 1971.
- Porter IA, Reid TMS. A milk-borne outbreak of *Campylobacter* infection. *J Hyg Camb* 84:415, 1980.

- Potel J. Aetiologie der Granulomatosis Infantiseptica. *Wiss Z Martin Luther Univ* 2:15, 1953/1954.
- Potter ME, Blaser MJ, Sikes RK, Kaufmann AF, Wells JG. Human *Campylobacter* infection associated with certified raw milk. *Am J Epidemiol* 117:475, 1983.
- Pounder RE. The pathogenesis of Crohn's disease. *Gastroenterology* 29(suppl 7):11, 1994.
- Pourshafie MR, Saifie M, Shafiee A, Vahdani P, Aslani M, Salemian J. An outbreak of food-borne botulism associated with contaminated locally made cheese in Iran. *Scand J Infect Dis* 30:92, 98.
- Price RM. Milk and its relation to tuberculosis. *Can Public Health J* 25:13, 1934.
- Pritchard TJ, Beliveau CM, Flanders KJ, Donnelly CW. Environmental surveillance of dairy processing plants for the presence of *Yersinia* species. *J Food Prot* 58:395, 1995.
- Prober CG, Tune B, Hoder L. *Yersinia pseudotuberculosis* septicemia. *Am J Dis Child* 133:623, 1979.
- Procter ME, Brosch R, Mellen JW, Garrett LA, Kasper CW, Luchansky JB. Use of pulsed-field gel electrophoresis to link sporadic cases of invasive listeriosis with recalled chocolate milk. *Appl Environ Microbiol* 61:3177, 1995.
- Pullinger EJ, Kemp AE. Growth of *Salmonella typhi* and certain other members of the *Salmonella* group in milk and butter stored at atmospheric temperatures. *J Hyg* 38: 587, 1938.
- Purvis JD, Morris GC. Report of a food-borne streptococcus outbreak. *US Naval Bull* 46: 613, 1946.
- Quinn J, Keon N, Coohon DB, Scott RM. Bovine tuberculosis—Michigan. *Morbid Mortal Weekly Rep* 23:166, 1974.
- Raamsaran H, Chen J, Brunke B, Hill A, Griffiths MW. Survival of bioluminescent *Listeria monocytogenes* and *Escherichia coli* O157:H7 in soft cheeses. *J Dairy Sci* 81: 1810, 1998.
- Rammel CG. *Brucella* in dairy products: a review. *Austral J Dairy Technol* 22:40, 1967.
- Rangasamy PN, Iyer M, Roginski H. Isolation and characterization of *Bacillus cereus* in milk and dairy products manufactured in Victoria. *Austral. J Dairy Technol* 48:93, 1993.
- Raska K, Helcl J, Jezek J, Kubelka Z, Litov M, Novak K, Radkovsky J, Sery V, Zejdl J, Zikmund V. A milk-borne infectious hepatitis epidemic. *J Hyg Epidemiol Microbiol Immunol* 10:413, 1966.
- Ratnam S, March SB. Laboratory studies on *Salmonella*-contaminated cheese involved in a major outbreak of gastroenteritis. *J Appl Bacteriol* 61:51, 1986.
- Read RB Jr, Bradshaw JG, Francis DW. Growth and toxin production of *Clostridium botulinum* type E in milk. *J Dairy Sci* 53:1183, 1970.
- Reilly WJ, Sharp JCM, Forbes GI, Paterson GM. Milkborne salmonellosis in Scotland 1980 to 1982. *Vet Rec* 112:578, 1983.
- Reitsma CJ, Henning DR. Survival of enteropathogenic *Escherichia coli* O157:H7 during the manufacture and curing of cheddar cheese. *J Food Prot* 59:460, 1996.
- Remington JS, McLeod R. Toxoplasmosis. In: Braude AI, Davis CE, Fierer J, eds. *Infectious Diseases and Medical Microbiology*. 2nd ed. Philadelphia: WB Saunders, 1986, p 1521.

- Renwick SA, Wilson JB, Clark RC, Lior H, Borczyk AA, Spika J, Rahn JK, McFadden K, Bouwer A, Capps A, Anderson NG, Alves D, Karmali MA. Evidence for direct transmission of *Escherichia coli* O157:H7 infection between calves and a human. *J Infect Dis* 168:792, 1993.
- Rhodehamel EJ, Harmon SM. *Bacillus cereus*. In: FDA Bacteriological Analytical Manual. 8th ed. Gaithersburg, MD: AOAC International, 1995, p 14.01.
- Rich ED, Fellow CE. A typhoid epidemic traced to cheese. *Am J Public Health* 13:210, 1923.
- Richardson GH. Dairy products. In: Helrich K, ed. Official Methods of Analysis of the Association of Official Analytical Chemists. 15th ed. Arlington, VA: AOAC, 1990, p 802.
- Richwald GA, Greenland S, Johnson BJ, Fruedland JM, Goldstein EJC, Plichta DT. Assessment of the excess risk of *Salmonella dublin* infection associated with the use of certified raw milk. *Public Health Rep* 103:489, 1988.
- Riemann HP, Meyer ME, Theis JH, Kelso G, Beymer DE. Toxoplasmosis in an infant fed unpasteurized goat milk. *J Pediatr* 87:573, 1975.
- Riley LW, Remis RS, Helgerson SD, McGee HB, Wells JG, Davis BR, Herbert RJ, Olcott ES, Johnson LM, Hargrett NT, Blake PA, Cohen ML. Hemorrhagic colitis associated with a rare *Escherichia coli* serotype. *N Engl J Med* 308:681, 1983.
- Riordan T, Humphrey TJ, Fowles A. A point source outbreak of *Campylobacter* infection related to bird-pecked milk. *Epidemiol Infect* 110:261, 1993.
- Robinson DA. Infectious dose of *Campylobacter jejuni* in milk. *BMJ* 282:1584, 1981.
- Robinson DA, Jones DM. Milk-borne *Campylobacter* infection. *BMJ* 282:1374, 1981.
- Robinson DA, Edgar WM, Gibson GL, Matchett AA, Robertson L. *Campylobacter* enteritis associated with consumption of unpasteurized milk. *Br J Med* 1:1171, 1979.
- Rodriguez MH, Barrett EL. Changes in microbial population and growth of *Bacillus cereus* during storage of reconstituted dry milk. *J Food Prot* 49:680, 1986.
- Rodriguez-Alvarez C, Hardisson A, Alvarez R, Arias A, Sierra A. Enterobacteriaceae in ice cream sold at retail in Tenerife, Spain. *J Food Quality* 17:423, 1994.
- Rohrbach BW, Draughon FA, Davidson MP, Oliver SP. Prevalence of *Listeria monocytogenes*, *Campylobacter jejuni*, *Yersinia enterocolitica*, and *Salmonella* in bulk tank milk: risk factors and risk of human exposure. *J Food Prot* 55:93, 1992.
- Romanova TV, Shkarin VV, Khazenson LB. Group cryptosporidiosis morbidity in children. *MeditSink Parazit Parazitarn Bolezni* 3:50, 1992.
- Rosenau MJ, Frost WD, Bryant R. A study of the butter market of Boston. *J Med Res* 25:69, 1914.
- Rosenow EM, Marth EH. Growth of *Listeria monocytogenes* in skim, whole and chocolate milk, and in whipping cream during incubation at 4, 8, 13, 21 and 35°C. *J Food Prot* 50:452, 1987.
- Rowan, NJ, Anderson JG. Diarrhoeal enterotoxin production by psychrotrophic *Bacillus cereus* present in reconstituted milk-based infant formulae (MIF). *Lett Appl Microbiol* 26:161, 1998.
- Rowan, NJ, Anderson JG, Anderton A. Bacteriological quality of infant milk formulae examined under a variety of preparation and storage conditions. *J Food Prot* 60: 1089, 1997.

- Rowe B, Begg NT, Hutchinson DN, Dawkins HC, Gilbert RJ, Jacob M, Hales BH, Rae FA, Jepson M. *Salmonella ealing* infections associated with consumption of infant dried milk. *Lancet* 2:900, 1987.
- Ryan CA, Nickels MK, Hargrett-Bean NT, Potter ME, Endo T, Mayer L, Langkop CW, Gibson C, McDonald RC, Kenney RT, Puhr ND, McDonnell PJ, Martin RJ, Cohen ML, Blake PA. Massive outbreak of antimicrobial resistant salmonellosis traced to pasteurized milk. *JAMA* 258:3269, 1987.
- Ryan JL. Bites: *P. multocida*, DF-2, *S. moniliformis*, and *S. minor*. In: Braude AI, Davis CE, Fierer J, eds. *Infectious Diseases and Medical Microbiology*. 2nd ed. Philadelphia: WB Saunders, 1986, p 1499.
- Ryser ET. Incidence and behavior of *Listeria* in fermented dairy products. In: Ryser ET, Marth EH, eds. *Listeria, Listeriosis and Food Safety*. 2nd ed. New York: Marcel Dekker, 1999c, p 411.
- Ryser ET. Incidence and behavior of *Listeria* in unfermented dairy products. In: Ryser ET, Marth EH, eds. *Listeria, Listeriosis and Food Safety*. 2nd ed. New York: Marcel Dekker, 1999b, p 359.
- Ryser ET. Foodborne listeriosis. In: Ryser ET, Marth EH, eds. *Listeria, Listeriosis and Food Safety*, 2nd ed. New York: Marcel Dekker, 1999a, p 299.
- Ryser ET, Doyle MP, Marth EH. Survival of *Listeria monocytogenes* during manufacture and storage of cottage cheese. *J Food Prot* 48:746, 1985.
- Ryser ET, Marth EH. Behavior of *Listeria monocytogenes* during the manufacture and ripening of cheddar cheese. *J Food Prot* 50:7, 1987a.
- Ryser ET, Marth EH. Fate of *Listeria monocytogenes* during manufacture and ripening of Camembert cheese. *J Food Prot* 50:372, 1987b.
- Ryser ET, Marth EH. Survival of *Listeria monocytogenes* in cold-pack cheese food during refrigerated storage. *J Food Prot* 51:615, 1988a.
- Ryser ET, Marth EH. Behavior of *Listeria monocytogenes* during manufacture and ripening of brick cheese. *J Dairy Sci* 72:838, 1988b.
- Ryser ET, Marth EH. *Listeria, Listeriosis and Food Safety*. New York: Marcel Dekker, 1991.
- Ryser ET, Marth EH, eds. *Listeria, Listeriosis and Food Safety*. 2nd ed. New York: Marcel Dekker, 1999.
- Sabbaghian H, Nadim M. Epidemiology of human brucellosis in Isfahan, Iran. *J Hyg* 73: 221, 1974.
- Sabioni JG, Hirooka EY, de Souza MLR. Food poisoning from Minas-type cheese contaminated with *Staphylococcus aureus*. *Rev Saude Publ S Paulo* 22:458, 1988.
- Sacks JJ, Roberto RR, Brooks NF. Toxoplasmosis infection associated with raw goat's milk. *JAMA* 128:1728, 1982.
- Sakhre PG, Vyas SH. The incidence of *Mycobacterium tuberculosis* in milk from clinically healthy udders of tuberculin positive Kankej cows. *Food Farming Agric* 11:260, 1978.
- Salama SM, Bolton FJ, Hutchinson DN. Application of a new phage typing scheme to campylobacters isolated during outbreaks. *Epidemiol Infect* 104:405, 1990.
- Salman MD, Meyer ME. Epidemiology of bovine brucellosis in the Mexicalli Valley, Mexico: literature review of disease-associated factors. *Am J Vet Res* 45:1557, 1984.

- Sancak YC, Boynukara B, Yardimci H. The occurrence and survival of *Brucella* spp. in Van Herby cheese. *Veterinarium* 4:1, 1993.
- Sanchez-Rey R, Poulett B, Caceres P, Larriba G. Microbiological quality and incidence of some pathogenic microorganisms in La Serena cheese throughout ripening. *J Food Prot* 56:879, 1993.
- Sanderson JD, Moss MT, Tizard ML, Hermon-Taylor J. *Mycobacterium paratuberculosis* DNA in Crohn's disease tissue. *Gut* 33:890, 1992.
- Savage WG. Mitchel lecture on human tuberculosis of bovine origin. *BMJ* 2:905, 1933.
- Schaack MM, Marth EH. Behavior of *Listeria monocytogenes* in skim milk during fermentation with mesophilic lactic acid bacteria starter cultures. *J Food Prot* 51:600, 1988a.
- Schaack MM, Marth EH. Behavior of *Listeria monocytogenes* in skim milk and in yogurt mix during fermentation with thermophilic lactic acid bacteria starter cultures. *J Food Prot* 51:607, 1988b.
- Schiemann DA. Association of *Yersinia enterocolitica* with the manufacture of cheese and occurrence in pasteurized milk. *Appl Environ Microbiol* 36:274, 1978.
- Schiemann DA. *Yersinia enterocolitica* in milk and dairy products. *J Dairy Sci* 70:383, 1987.
- Schiemann DA. *Yersinia enterocolitica* and *Yersinia pseudotuberculosis*. In: Doyle MP, ed. *Foodborne Bacterial Pathogens*. New York: Marcel Dekker, 1989, p 601.
- Schiemann DA, Toma S. Isolation of *Yersinia enterocolitica* from raw milk. *Appl Environ Microbiol* 35:54, 1978.
- Schiemann DA, Wauters G. *Yersinia*. In: Vanderzant C, Splittstoesser DF, eds. *Compendium of Methods for the Microbiological Examination of Foods*. Washington, DC: American Public Health Association, 1992, p 433.
- Schindler AF. Temperature limits for production of aflatoxin by twenty-five isolates of *Aspergillus flavus* and *Aspergillus parasiticus*. *J Food Prot* 40:39, 1977.
- Schleifstein JI, Coleman MB. An unidentified organism resembling *B. ligneri* and *Past. pseudotuberculosis*, and pathogenic for man. *NY State J Med* 39:1749, 1939.
- Schmitt N, Bowmer EJ, Willoughby BA. Food poisoning outbreak attributed to *Bacillus cereus*. *Can J Public Health* 67:418, 1976.
- Schnurrenberger LW, Pate J. Gastroenteritis attributed to imported French cheese—United States. *Morbidity Mortality Weekly Rep* 20:425, 1971.
- Schroeder EC, Brett GW. Public health studies concerning cheese. *J Am Vet Med Assoc* 5:674, 1918.
- Schuman JD, Zottola EA, Harlander SK. Preliminary characterization of a food-borne multiple-antibiotic-resistant *Salmonella typhimurium* strain. *Appl Environ Microbiol* 55:2344, 1989.
- Schussler JM, Fenves AZ, Sutker WL. Intermittent fever and pancytopenia in a young Mexican man. *Southern. Med J* 90:1037, 1997.
- Scott PM. Mycotoxigenic fungal contaminants of cheese and other dairy products. In: van Egmond HP, ed. *Mycotoxins in Dairy Products*. London: Elsevier Applied Science, 1989, p 193.
- Scott PM. Natural poisons—Mycotoxins. In: Helrich K, ed. *Official Methods of Analysis of the Association of Official Analytical Chemists*. 15th ed. Arlington, VA: AOAC, 1990, p 1184.

- Scott WM, Minett FC. Experiments on infection of cows with typhoid bacilli. *J Hyg* 45: 159, 1947.
- Sebald M, Jouglard J, Gilles G. Type B botulism in man due to cheese. *Ann Microbiol Inst Pasteur* 125A:349, 1974.
- Sedlak J. Present knowledge and aspects of *Citrobacter*. *Curr Topics Microbiol Immunol* 62:41, 1973.
- Seiber SM, Correa P, Dalgard DW, Adamson RH. Induction of osteogenic sarcomas and tumors of the hepatobiliary system in non-human primates with aflatoxin B₁. *Cancer Res* 39:4545, 1979.
- Serbezov V, Kazar J, Novkirishki, Gatcheva N, Kovacova E, Voynova V. Q fever in Bulgaria and Slovakia. *Emerg Infect Dis* 5:388, 1999.
- Seyffert WA, Bernard JA. Brucellosis: report of six cases. *Texas Med* 65:47, 1969.
- Shahamat M, Seaman A, Woodbine M. Survival of *Listeria monocytogenes* in high salt concentrations. *Zbl Bakteriol Hyg I Abt Orig A*, 246:506, 1980.
- Shanson DC, Gazzard BG, Midgley J, Dixey J, Gibson GL, Stevenson J, Finch RG, Cheesbrough J. *Streptococcus moniliformis* isolated from blood in four cases of Haverhill fever. *Lancet* i:92, 1983.
- Sharp JCM. Infections associated with milk and dairy products in Europe and North America, 1980–85. *Bull WHO* 65:397, 1987.
- Shayegani M, Morse M, DeForge I, Root T, Malmberg Parsons L, Maupin PS. Microbiology of a major foodborne outbreak of gastroenteritis caused by *Yersinia enterocolitica* serogroup O:8. *J Clin Microbiol* 17:35, 1983.
- Shih CN, Marth EH. Experimental production of aflatoxin on brick cheese. *J Milk Food Technol* 35:585, 1972.
- Simms L, MacRae IC. Survival of *Campylobacter jejuni* in raw, pasteurized and ultra-heat-treated goat's milk stored at different temperatures. *Lett Appl Microbiol* 8: 177, 1989.
- Sims GR, Glenister DA, Brocklehurst TF, Lund BM. Survival and growth of food poisoning bacteria following inoculation into cottage cheese varieties. *Int J Food Microbiol* 9:173, 1989.
- Sims JE, Kelley DC, Foltz VD. Effects of time and temperature on salmonellae in inoculated butter. *J Milk Food Technol* 32:485, 1970.
- Singh RS, Ranganathan B. Occurrence of enteropathogenic *Escherichia coli* serotypes in milk and milk products. *Milchwissenschaft* 29:529, 1974.
- Sinnhuber RO, Lee DJ, Wales JH, Landers MK, Keyl AC. Hepatic carcinogenesis of aflatoxin M₁ in rainbow trout (*Salmo gairdneri*). *J Nat Cancer Inst* 53:1285, 1974.
- Skirrow MB. Campylobacteritis: a "new" disease. *BMJ* 2:9, 1977.
- Slutsker L, Schuchat A. Listeriosis in humans. In: Ryser ET, Marth EH, eds. *Listeria*, Listeriosis and Food Safety. 2nd ed. New York: Marcel Dekker, 1999, p 75.
- Small RG, Sharp JCM. A milk-borne outbreak due to *Salmonella dublin*. *J Hyg Camb* 82:95, 1979.
- Smith GR. Botulism. In: Smith GR, Easmon CSF, eds. Topley and Wilson's Principles of Bacteriology, Virology and Immunity. 8th ed. Vol 3—Bacterial Diseases. Philadelphia: BC Decker, 1990, p 513.
- Smith JL. *Cryptosporidium* and *Giardia* as agents of foodborne disease. *J Food Prot* 56: 451, 1993.

- Sneath PHA. Endospore-forming gram-positive rods and cocci. In: Sneath PH, Mair NS, Sharpe ME, Holt JG, eds. *Bergey's Manual of Systematic Bacteriology*. Vol 2. Baltimore: Williams & Wilkins, 1986, p 1104.
- Sockett PN. Communicable disease associated with milk and dairy products: England and Wales 1987–1989. *Commun Dis Rep* 1:R-9, 1991.
- Sockett PN, Cowden JM, Le Baigue S, Ross D, Adak GK, Evans H. Foodborne disease surveillance in England and Wales: 1989–1991. *Comm Dis Rep* 3(12):R159, Nov. 5, 1993.
- Solodovnikov IP, Aleksandrovskaia IM. Multiyear observations of the dynamic epidemic process in sonne dysentery in a small district of Vladimir Province. *Zh Mikrobiol Epidemiol Immunobiol* 9–10:41, 1992.
- Solomon HM, Rhodehamel EJ, Kautter DA. *Clostridium botulinum*. In: *FDA Bacteriological Analytical Manual*. 8th ed. Gaithersburg, MD: AOAC International, 1995, p 17.01.
- Somers EB, Taylor SL. Antibotulinal effectiveness of nisin in pasteurized process cheese spreads. *J Food Prot* 50:842, 1987.
- Southern JP, Smith RMM, Palmer SR. Bird attack on milk bottles: Possible mode of transmission of *Campylobacter jejuni* to man. *Lancet* 336:1425, 1990.
- Spira WM, Goepfert JM. *Bacillus cereus*—induced fluid accumulation in rabbit ileal loops. *Appl Microbiol* 24:341, 1972.
- Spolaor D. A microbial agent in the limelight: *Clostridium botulinum*. *Informatore Agrario* 52:45, 1996.
- Stadhouders J, Cordes MM, van Schouwenburg-van Foeken AWJ. The effect of manufacturing conditions on the development of staphylococci in cheese. Their inhibition by starter bacteria. *Neth Milk Dairy J* 32:193, 1978.
- Stadhouders J, Hup G, Langeveld LPM. Some observations on the germination, heat resistance and outgrowth of fast-germinating and slow-germinating spores of *Bacillus cereus* in pasteurized milk. *Neth Milk Dairy J* 34:215, 1980.
- Stadler H, Isler R, Stutz W, Salfinger M, Lauwers S, Vischer W. Beitrag zur Epidemiologie von *Campylobacter jejuni* von der asymptomatischen Ausscheidung im Stall zur Erkrankung bei über 500 Personen. *Schweiz med Wschr* 7:245, 1983.
- Stahl S. Tuberculosis infection due to milk. *Am J Public Health* 29:1154, 1939.
- Stanfield JT, Jackson GJ, Aulisio CCG. *Yersinia enterocolitica*: survival of a pathogenic strain on milk containers. *J Food Prot* 48:947, 1985.
- Stecchini ML, Sarais I, de Bertoldi M. The influence of *Lactobacillus plantarum* culture inoculation on the fate of *Staphylococcus aureus* and *Salmonella typhimurium* in Montasio cheese. *Int J Food Microbiol* 14:99, 1991.
- Steede FDF, Smith HW. Staphylococcal food-poisoning due to infected cow's milk. *BMJ* 2:576, 1954.
- Steele JH, Ranney AF. Animal tuberculosis. *Am Rev Tuberc* 77:908, 1958.
- Steele BT, Murphy N, Arbus GS, Rance CP. An outbreak of hemolytic uremic syndrome associated with ingestion of fresh apple juice. *J Pediatr* 101:963, 1982.
- Steele ML, McNab WB, Poppe C, Griffiths MW, Chen S, Degrandis SA, Fruhner LC, Larkin CA, Lynch JA, Odumeru JA. Survey of Ontario bulk tank milk raw milk for food-borne pathogens. *J Food Prot* 60:1341, 1997.
- Steere AC, Craven PJ, Hall WJ III, Leotsakis N, Wells JG, Farmer JJ III, Gangarosa EJ.

- Person-to-person spread of *Salmonella typhimurium* after a hospital common-source outbreak. *Lancet* i:319, 1975.
- Stern NJ, Pierson MD, Kotula AW. Growth and competitive nature of *Yersinia enterocolitica* in whole milk. *J Food Sci* 45:972, 1980.
- Stern NJ, Kazmi SU. Less recognized and presumptive foodborne pathogenic bacteria. In: Doyle MP, ed. *Foodborne Bacterial Pathogens*. New York: Marcel Dekker, 1989, p 71.
- Stern NJ, Patton CM, Doyle MP, Park CE, McCardell BA. *Campylobacter*. In: Vanderzant C, Splittstoesser DF, eds. *Compendium of Methods for the Microbiological Examination of Foods*. Washington, DC: American Public Health Association, 1992, p 475.
- Stevens AJ, Saunders CN, Spence JB, Newnham AG. Investigation into "disease" of turkey poults. *Vet Rec* 72:627, 1960.
- Stewart J, Sufi F, McNulty C, Park P. Outbreak of *Campylobacter* enteritis in a residential school associated with bird pecked bottle tops. *Commun Dis Rep CDR Rev* 7:R38, 1997.
- Stiles ME. Less recognized or presumptive foodborne pathogenic bacteria. In: Doyle MP, ed. *Foodborne Bacterial Pathogens*. New York: Marcel Dekker, 1989, p 673.
- Stoloff L. Aflatoxin M₁ in perspective. *J Food Prot* 43:226, 1980.
- Stone RV. Staphylococci food-poisoning and dairy products. *J Milk Technol* 6:7, 1943.
- Stratton JE, Hutkins RW, Taylor SL. Biogenic amines in cheese and other fermented foods: a review. *J Food Prot* 54:460, 1991.
- Street L Jr, Grant WW, Alva JD. Brucellosis in childhood. *Pediatr* 55:416, 1975.
- Stubblefield RD, Shannon GM. Aflatoxin M₁: Analysis in dairy products and distribution in dairy foods made from artificially contaminated milk. *JAOAC* 57:847, 1974.
- Stubblefield RD, van Egmond HP. Chromatographic methods of analysis for aflatoxin M₁. In: van Egmond HP, ed. *Mycotoxins in Dairy Products*. London: Elsevier Applied Science, 1989, p 57.
- Styliadis S, Barnum D. *Salmonella* Infection in Man and Animals in the Province of Ontario. In: *Proceedings of the International Symposium of Salmonella*, New Orleans, LA, 1984, p 200.
- Su, Y-C, Wong ACL. Identification and purification of a new staphylococcal enterotoxin H. *Appl Environ Microbiol* 61:1438, 1995.
- Suchowiak T, Haiat Z. Milk-spread *Salmonella* enteritis epidemic in the Wroclaw province in June 1978. *Przeg Epidemiol* 34:325, 1980.
- Sumner SS, Roche F, Taylor SL. Factors controlling histamine production in Swiss cheese inoculated with *Lactobacillus buchneri*. *J Dairy Sci* 73:3050, 1990.
- Sumner SS, Speckhard MW, Somers EB, Taylor SL. Isolation of histamine-producing *Lactobacillus buchneri* from Swiss cheese implicated in a food poisoning outbreak. *Appl Environ Microbiol* 50:1094, 1985.
- Sun P, Chu FS. A simple solid-phase radioimmunoassay for aflatoxin B₁. *J Food Safety* 1:67, 1977.
- Sung N, Collins MT. Thermal tolerance of *Mycobacterium paratuberculosis*. *Appl Environ Microbiol* 64:999, 1998.
- Swaminathan B, Rocourt J, Bille J. *Listeria*, identification of foodborne bacterial patho-

- gens by gene probes. In: Murray PR, Baron EJ, Pfaller MA, Tenover FC, Tenover RH, eds. *Manual of Clinical Microbiology* 6th ed. Washington, DC: ASM Press, 1995, p 341.
- Sweeney RW, Whitlock RH, Rosenberger AE. *Mycobacterium paratuberculosis* cultured from milk and supramammary lymph nodes of infected asymptomatic cows. *J Clin Microbiol* 30:166, 1992.
- Tacket CO, Davis BR, Carter GP, Randolph JF, Cohen ML. *Yersinia enterocolitica* pharyngitis. *Ann Intern Med* 99:40, 1983.
- Tacket CO, Narain JP, Sattin R, Lofgren JP, Konigsberg C, Rendtorff RC, Rausa A, Davis BR, Cohen ML. A multistate outbreak of infections caused by *Yersinia enterocolitica* transmitted by pasteurized milk. *JAMA* 251:483, 1984.
- Tan L, Williams MA, Khan MK, Champion HC, Nielsen NH. Risk of transmission of bovine spongiform encephalopathy to humans in the United States: report of the Council on Scientific Affairs. *AMA. JAMA* 281:2330, 1999.
- Tanaka N, Goepfert JM, Traisman E, Hoffbeck WM. A challenge of pasteurized process cheese spread with *Clostridium botulinum* spores. *J Food Prot* 42:787, 1979.
- Tanaka N, Traisman E, Plantinga P, Finn L, Flom W, Meske L, Guggisberg J. Evaluation of factors involved in antibotulinal properties of pasteurized process cheese spreads. *J Food Prot* 49:526, 1986.
- Tarala J. Some observations on bovine brucellosis, its eradication and its relation to undulant fever. *State Vet J* 24:220, 1969.
- Tatini SR, Wesala WD, Jezeski JJ, Morris HA. Production of staphylococcal enterotoxin A in blue, brick, mozzarella, and Swiss cheese. *J Dairy Sci* 56:429, 1973.
- Taylor A Jr, Santiago A, Gonzalez-Cortes A, Gangarosa EJ. Outbreak of typhoid fever in Trinidad in 1971 traced to a commercial ice cream product. *Am J Epidemiol* 100:150, 1974.
- Taylor DN. *Campylobacter* infections in developing countries. In: Nachamkin I, Blaser NJ, Tompkins LS, eds. *Campylobacter jejuni: Current Status and Future Trends*. Washington, DC: American Society of Microbiology, 1992, p 20.
- Taylor DN, Porter BW, Williams CA, Miller HG, Bopp CA, Blake PA. *Campylobacter* enteritis: a large outbreak traced to commercial raw milk. *West J Med* 137:365, 1982a.
- Taylor PR, Weinstein WM, Bryner JH. *Campylobacter fetus* infection in human subjects: association with raw milk. *Am J Med* 66:779, 1979.
- Taylor SL. Histamine poisoning associated with fish, cheese and other foods. Monograph WHO, 1985.
- Taylor SL. Histamine food poisoning: toxicology and clinical aspects. *Crit Rev Toxicol* 17:91, 1986.
- Taylor SL, Keefe TJ, Windham ES, Howell JF. Outbreak of histamine poisoning associated with the consumption of Swiss cheese. *J Food Prot* 45:455, 1982b.
- Taylor TK, Wilks CR, McQueen DS. Isolation of *Mycobacterium paratuberculosis* from the milk of a cow with Johne's disease. *Vet Rec* 109:532, 1981.
- Teclaw RF, Heck H, Wagner GG, Romo S, Garcia Z. Prevalence of brucellosis infection in cattle in the Mexican state of Nuevo Leon, Tamaulipas and Coahuila as determined by the ELISA. *Prev Vet Med* 3:445, 1985.

- Terhune C, Sazi E, Kalishman N, Bobst J, Bonnlander B, Googins JA, Williams P. Raw-milk-associated illness—Oregon, California. *Morbidity and Mortality Weekly Report* 30:90, 1981.
- Ter Steeg PF, Cuppers HGAM. Growth of proteolytic *Clostridium botulinum* in process cheese products: II. Predictive modeling. *J Food Prot* 58:1100, 1995.
- Ter Steeg PF, Cuppers HGAM, Hellemons JC, Rijke G. Growth of proteolytic *Clostridium botulinum* in process cheese products: I. Data acquisition for modeling the influence of pH, sodium chloride, emulsifying salts, dry fat basis and temperature. *J Food Prot* 58:1091, 1995.
- Tham W. Survival of *Listeria monocytogenes* in cheese made of unpasteurized goat milk. *Acta Vet Scand* 29:165, 1988.
- Thapar MK, Young EJ. Urban outbreak of goat cheese brucellosis. *Pediatr Infect Dis* 5: 640, 1986.
- Tibana A, Barbosa Warnken M, Paiva Nunes M, Delgado Ricciardi I, Solino Noletto AL. Occurrence of *Yersinia* species in raw and pasteurized milk in Rio de Janeiro, Brazil. *J Food Prot* 50:580, 1987.
- Todd E, Szabo R, Roborn H, Gleeson T, Park C, Clark DS. Variation in counts, enterotoxin levels and Tnase in Swiss-type cheese contaminated with *Staphylococcus aureus*. *J Food Prot* 44:939, 1981.
- Toora S, Budu-Amoako E, Ablett RF, Smith J. Effect of high-temperature short-time pasteurization, freezing and thawing and constant freezing, on the survival of *Yersinia enterocolitica* in milk. *J Food Prot* 55:803, 1992.
- Tornadijo E, Fresno JM, Carballo J, Martin-Sarmiento R. Study of Enterobacteriaceae throughout the manufacturing and ripening of hard goat's cheese. *J Appl Bacteriol* 75:240, 1993.
- Townes JM, Cieslak PR, Hatheway CL, Solomon HM, Holloway JT, Baker MP, Keller CF, McCroskey LM, Griffith PM. An outbreak of type A botulism associated with a commercial cheese sauce. *Ann Intern Med* 125:558, 1996.
- Tschape H, Prager R, Steckel W, Fruth A, Tietze E, Bohme G. Verotoxigenic *Citrobacter freundii* associated with severe gastroenteritis and cases of haemolytic uraemic syndrome in a nursery school: green butter as the infection source. *Epidemiol Infect* 114:441, 1995.
- Tsen H-Y, Chi W-R, Lin C-K. Use of novel polymerase chain reaction primers for the specific detection of heat-labile toxin I, heat-stable toxin I and II enterotoxigenic *Escherichia coli* in milk. *J Food Prot* 59:795, 1996.
- Tucker CB, Fulkerson GC, Neudecker RM. A milk-borne outbreak of shigellosis in Madison County, Tenn. *Public Health Rep* 69:432, 1954.
- Tulloch FE, Ryan KJ, Formal SB, Franklin FA. Invasive enteropathogenic *Escherichia coli*—an outbreak in 28 adults. *Ann Intern Med* 79:13, 1973.
- Turck WPG. Q fever. In: Braude AI, Davis CE, Fierer J, eds. *Infectious Diseases and Medical Microbiology*. 2nd ed. Philadelphia: WB Saunders, 1986, p 810.
- Tzipori S. Cryptosporidiosis in animals and humans. *Microbiol Rev* 47:84, 1983.
- Ueno Y. The toxicology of mycotoxins. *CRC Crit Rev Toxicol* 14:99, 1985.
- Uragoda CG, Lodha SC. Histamine intoxication in a tuberculosis patient after ingestion of cheese. *Tubercle* 60:56, 1979.
- Valkenburg HA. Streptococcal pharyngitis and tonsillitis. In: Braude AI, Davis CE, Fierer

- J, eds. Infectious Diseases and Medical Microbiology. 2nd ed. Philadelphia: WB Saunders, 1986, p 715.
- Valsanen OM, Mwaishumo NJ, Salkinoja-Salonen MS Differentiation of dairy strains of the *Bacillus cereus* group by phage typing, minimum growth temperature, and fatty acid analysis. *J Appl Bacteriol* 70:315, 1991.
- Van den Heever LW. Tuberculosis in milch goats. *J South Afr Vet Assoc* 55:219, 1984.
- van Egmond HP. Introduction. In: van Egmond HP, ed. *Mycotoxins in Dairy Products*. London: Elsevier Applied Science, 1989a, p 1.
- van Egmond HP. Aflatoxin M₁: Occurrence, toxicity, regulation. In: van Egmond HP, ed. *Mycotoxins in Dairy Products*. London: Elsevier Applied Science, 1989b, p 11.
- van Netten P, van de Moosdijk A, van Hoensel P. Psychrotrophic strains of *Bacillus cereus* producing enterotoxin. *J Appl Bacteriol* 69:73, 1990.
- Varadaraj MC, Nambudripad VKN. Growth and production of thermostable deoxyribonuclease and enterotoxin by *Staphylococcus aureus* in milk. *Milchwissenschaft* 38: 23, 1983.
- Vasenin AA, Kogan VM, Nekipelova GA, Leonov VA, Gerasimova LF. Epidemiological characteristics of tick-borne encephalitis foci in traditional landscapes of Pribaikalia. *Med Parazit Paravit Bol* 44:56, 1975.
- Vazquez BI, Fente C, Franco CM, Quinto E, Cepeda A, Prognon P. Rapid semi-quantitative fluorimetric determination of citrinin in fungal cultures. *Lett Appl Microbiol* 24:3397, 1997.
- Vazquez BI, Fente C, Quinto E, Franco CM, Rodriguez JL, Cepeda A, Belda BV, Sampayo CAF, Fernandez EQ, Abuin CF, Otero JLR, Saez AC. Incidence of toxigenic moulds in farm-level cheesemaking units from Arzua (La Coruna, Spain). *Food Sci Technol Intern* 1:91, 1995.
- Veldman A, Meijjs JAC, Borggreve GJ, Heeres-van-der-Tol JJ. Carry-over of aflatoxin from cow's food to milk. *Animal Prod* 55:163, 1992.
- Villar RG, Macek MD, Simons S, Hayes PS, Goldoft MJ, Lewis JH, Rowan LL, Hursh D, Patnode M, Mead PS. Investigation of multidrug-resistant *Salmonella* serotype Typhimurium DT104 infections linked to raw milk cheese in Washington state. *JAMA* 281:1811, 1999.
- Vidon DJM, Delmas CL. Incidence of *Yersinia enterocolitica* in raw milk in eastern France. *Appl Environ Microbiol* 41:355, 1981.
- Vogt T, Hasler P. A woman with panic attacks and double vision who liked cheese. *Lancet* 354:300, 1999.
- Vogt RL, Little AA, Patton CM, Barrett TJ, Orciari LA. Serotyping and serology studies of campylobacteriosis associated with consumption of raw milk. *J Clin Microbiol* 20:998, 1984.
- Vought KJ, Tatini SR. *Salmonella enteritidis* contamination of ice cream associated with a 1994 multistate outbreak. *J Food Prot* 61:5, 1998.
- Wachsmuth K, Morris GK. *Shigella*. In: Doyle MP, ed. *Foodborne Bacterial Pathogens*. New York: Marcel Dekker, 1989, p 447.
- Wade EM, Shere L. Longevity of typhoid bacilli in cheddar cheese—a study following an outbreak of typhoid fever traced to cheese. *Am J Public Health* 18:1480, 1928.

- Wagenaar RO, Dack GM. Factors influencing growth and toxin production in cheese inoculated with spores of *Clostridium botulinum* types A and B. I. Studies with surface-ripened cheese type I. J Dairy Sci 41:1182, 1958a.
- Wagenaar RO, Dack GM. Factors influencing growth and toxin production in cheese inoculated with spores of *Clostridium botulinum* types A and B. II. Studies with surface-ripened cheese type II. J Dairy Sci 41:1191, 1958b.
- Wagenaar RO, Dack GM. Factors influencing growth and toxin production in cheese inoculated with spores of *Clostridium botulinum* types A and B. III. Studies with surface-ripened cheese type III. J Dairy Sci 41:1196, 1958c.
- Walker SJ, Gilmour A. The incidence of *Yersinia enterocolitica* and *Yersinia enterocolitica*-like organisms in raw and pasteurized milk in Northern Ireland. J Appl Bacteriol 61:133, 1986.
- Wallach JC, Miguel SE, Baldi PC, Guarnera E, Goldbaum FA, Fossati CA. Urban outbreak of a *Brucella melitensis* infection in an Argentine family: clinical and diagnostic aspects. Immun Med Microbiol 8:49, 1994.
- Wallach JC, Samartino LE, Efron A, Baldi C. Human infection by *Brucella melitensis*: an outbreak attributed to contact with infected goats. FEMS Immunol Med Microbiol 19:315, 1997.
- Wang G, Zhao T, Doyle MP. Survival and growth of *Escherichia coli* O157:H7 in unpasteurized and pasteurized milk. J Food Prot 60:610, 1997.
- Warburton DW, Peterkin PI, Weiss KF. A survey of the microbiological quality of processed cheese products. J Food Prot 49:229, 1986.
- Waterman SC. The heat sensitivity of *Campylobacter jejuni* in milk. J Hyg Camb 88:529, 1982.
- Weagant SD, Bryant JL, Jinneman KG. An improved rapid technique for isolation of *Escherichia coli* O157:H7 from foods. J Food Prot 58:7, 1995.
- Weagant SD, Feng P, Stanfield JT. *Yersinia enterocolitica* and *Yersinia pseudotuberculosis*. In: FDA Bacteriological Analytical Manual. 8th ed. Gaithersburg, MD: AOAC International, 1998, p 8.01.
- Weed LA, Michael AC, Harger RN. Fatal *Staphylococcus* intoxication from goat milk. Am J Public Health 33:1314, 1943.
- Wegmuller B, Luthy J, Candrain U. Direct polymerase chain reaction detection of *Campylobacter jejuni* and *Campylobacter coli* in raw milk and dairy products. Appl Environ Microbiol 59:2161, 1993.
- Weissman JB, Deen RMAD, Williams M, Swanston N, Ali S. An island-wide epidemic of salmonellosis traced to contaminated powdered milk. West Indian Med J 26:135, 1977.
- Wells JG, Davis BR, Wachsmuth IK, Riley LW, Remis RS, Sokolow R, Morris GK. Laboratory investigation of hemorrhagic colitis outbreaks associated with a rare *Escherichia coli* serotype. J Clin Microbiol 18:512, 1983.
- Wells JG, Shipman LD, Greene KD, Sowers EG, Green JH, Cameron DN, Downes FP, Martin ML, Griffin PM, Ostroff SM, Potter ME, Tauxe RV, Wachsmuth IK. Isolation of *Escherichia coli* serotype O157:H7 and other shiga-like-toxin-producing *E. coli* from dairy cattle. J Clin Microbiol 29:985, 1991.
- Werner SB, Humphrey BL, Kamei I. Association between raw milk and human *Salmonella dublin* infection. BMJ 2:238, 1979.

- White CH, Custer EW. Survival of *Salmonella* in cheddar cheese. *J Milk Food Technol* 39:328, 1976.
- Wieneke AA, Roberts D, Gilbert RJ. Staphylococcal food poisoning in the United Kingdom, 1969–1990. *Epidemiol Infect* 110:519, 1993.
- Wilkins EGL, Griffiths R, Roberts C. Guinea-pig inoculation for *Mycobacterium bovis*—Is it still necessary? *Tubercle* 68:311, 1987.
- Williams RC, Bodnauk PW, Golden DA. Survival of *Yersinia enterocolitica* during fermentation and storage of yogurt (abstr). Annual Meeting of the Institute of Food Technologists, New Orleans, LA, June 22–25, 1996.
- Wilson CD, Richards MS. A survey of mastitis in the British dairy herd. *Vet Rec* 107: 431, 1980.
- Wilson GS. The necessity for a safe milk supply. *Lancet* 2:829, 1933.
- Wisniewski HJ, Krumbiegel ER. Q fever in the Milwaukee area—I. Q fever in Milwaukee area cattle. *Arch Environ Health* 21:58, 1970a.
- Wisniewski HJ, Krumbiegel ER. Q fever in Milwaukee—III. Epidemiological studies of Q fever in humans. *Arch Environ Health* 21:66, 1970b.
- Wogan GN, Edwards GS, Newberne PM. Structure—activity relationship in toxicity and carcinogenicity of aflatoxins and analogs. *Cancer Res* 31:1936, 1971.
- Wolf FS, Floyd C, Carden W, Brown L, Armes WH. Staphylococcal food poisoning traced to butter—Alabama. *Morbidity Mortality Weekly Rep* 19:271, 1970.
- Wong H-C, Chang MH, Fan JY. Incidence and characterization of *Bacillus cereus* isolates contaminating dairy products. *Appl Environ Microbiol* 54:699, 1988.
- Wood DS, Collins-Thompson DL, Irvine DM, Myhr AN. Source and persistence of *Salmonella muenster* in naturally contaminated cheddar cheese. *J Food Prot* 47:20, 1984.
- Wood RC, MacDonald KL, Osterholm MT. *Campylobacter* enteritis outbreaks associated with drinking raw milk during youth activities: a 10-year review of outbreaks in the United States. *JAMA* 268:3228, 1992.
- Woodward WE, Gangarosa EJ, Brachman PS, Curlin GT. Foodborne disease surveillance in the United States, 1966 and 1967. *Am J Public Health* 60:130, 1970.
- Wright EP, Tillhet HE. Milk-borne *Campylobacter* enteritis in a rural area. *J Hyg Camb* 91:227, 1983.
- Wuethrich B. Back on the farm: stopping *E. coli* O157:H7 at its source. *ASM News* 60: 409, 1994.
- Wundt W, Schnittenhelm P. The behavior of salmonellae and staphylococci in cooled foods. *Arch Hyg Bakteriol* 149:567, 1965.
- Wyatt CJ, Timm EM. Occurrence and survival of *Campylobacter jejuni* in milk and turkey. *J Food Prot* 45:1218, 1982.
- Young EJ. Human brucellosis. *Rev Infect Dis* 5:821, 1983.
- Young EJ. Health issues at the US-Mexican border. *JAMA* 265:2066, 1991a.
- Young EJ. Serologic diagnosis of human brucellosis: analysis of 214 cases by agglutination tests and review of the literature. *Rev Infect Dis* 13:359, 1991b.
- Young EJ, Suvannoparrat U. Brucellosis outbreak attributed to ingestion of unpasteurized goat cheese. *Arch Intern Med* 135:240, 1975.
- Yousef AE, Marth EH. Degradation of aflatoxin M₁ in milk by ultraviolet energy. *J Food Prot* 48:697, 1985.

- Yousef AE, Marth EH. Use of ultraviolet energy to degrade aflatoxin M₁ in raw or heated milk with or without added peroxide. *J Dairy Sci* 69:2243, 1986.
- Yousef AE, Marth EH. Behavior of *Listeria monocytogenes* during the manufacture and storage of Colby cheese. *J Food Prot* 51:12, 1988.
- Yousef AE, Marth EH. Stability and degradation of aflatoxin M₁. In: van Egmond HP, ed. *Mycotoxins in Dairy Products*. London: Elsevier Applied Science, 1989, p 127.
- Yousef AE, Marth EH. Fate of *Listeria monocytogenes* during the manufacture and ripening of Parmesan cheese. *J Dairy Sci* 73:3351, 1990.
- Zanini MS, Moreira EC, Lopes MT, Mota P, Salas CE. Detection of *Mycobacterium bovis* in milk by polymerase chain reaction. *J Vet Med Ser B* 45:473, 1998.
- Zehren VL, Zehren VF. Examination of large quantities of cheese for staphylococcal enterotoxin A. *J Dairy Sci* 51:635, 1968a.
- Zehren VL, Zehren VF. Relation of acid development during the cheesemaking process and development of staphylococcal enterotoxin. *J Dairy Sci* 51:645, 1968b.
- Zottola EA, Jezeski JJ, Al-Dulaimi AN. Effect of short-time subpasteurization treatments on the destruction of *Staphylococcus aureus* in milk for cheese manufacture. *J Dairy Sci* 52:1707, 1969.

14

Cleaning and Sanitizing in Milk Production and Processing

Bruce R. Cords, George R. Dychdala, and Francis L. Richter

Ecolab, Inc.

St. Paul, Minnesota

I. INTRODUCTION

All food and dairy products are handled in plants that have modern processing equipment, utensils, and other auxiliary parts that must be cleaned and sanitized to produce food products that are safe for human consumption. Progressively automated cleaning systems have been developed to replace old and less efficient ones to increase productivity, provide safe working environments and, above all, guarantee safe and wholesome products for consumers. Good cleaning and sanitizing of food processing equipment is essential to assure safe food products with extended shelf life.

There are many different cleaners and sanitizers on the market, but in the food and dairy industries, there are only a few products that are permitted for use. For many years, the dairy industry has been the leader in developing sanitation standards and practices. This was done because of pronouncements by the U.S. Public Health Service that milk and milk products can be a potential major cause of infection and disease. Foodborne disease is very serious and can reach epidemic proportions. To eliminate dangers of an epidemic or costly recalls resulting from unsanitary conditions of milk and milk products, strict cleaning and sanitizing procedures must be observed throughout milk processing and packaging operations. This applies not only to milk products but also to other foods and beverages as well. To do this, chemical cleaners and sanitizers are available for use on equipment, utensils, and other food contact surfaces. Cleaning of the equipment surface represents the first step in sanitation to remove soils or films

that may harbor bacteria. Once the surface is clean, use of a sanitizer will complete the procedure. Good cleaning and sanitizing of food processing equipment is essential to produce high-quality food products that are safe and palatable for consumers.

II. PROCESS OF CLEANING

Five factors are involved with the practice of cleaning. These are (a) nature of soils, (b) water, (c) surfaces, (d) methods of application, and (e) environmental concerns.

A. Nature of Soils

A soil may be defined as unwanted material present on the surface of equipment or utensils that must be removed. After production of a food, most equipment is soiled and must be cleaned and sanitized to be prepared for subsequent production of the food. Soils are classified into two groups: visible and invisible. Soils vary in composition, necessitating a variety of cleaners that will dissolve, suspend, and remove any of these combinations. The choice of cleaner depends on the soil component that is most difficult to remove.

Soils or deposits must be removed and surfaces sanitized by selected cleaning and sanitizing procedures. Soil removal is best achieved by a combination of chemical, thermal, and mechanical action. Wetting, penetration, solvency, emulsification, saponification, and hydrolysis are some examples of chemical activity. Turbulent flow, pressure spraying, and scrubbing are examples of mechanical action. The major soil components of dairy and food products are lipids, proteins, carbohydrates, and mineral deposits.

1. Lipids

Lipids present in milk and milk products are best removed with alkalis that contain a synthetic detergent with emulsifying and suspending properties. Before a detergent is used, the temperature must be raised above the melting point of fat. Water above 55°C will melt fat. An alkaline detergent is then needed to emulsify, and suspend the fat to remove it from equipment.

2. Proteins

Proteins are usually the most difficult of food soils to remove, especially if they have been heated or dried, because these processes cause some denaturation to insoluble forms. A combination of alkali and a source of chlorine can remove proteins. This combination peptizes the protein into smaller, more soluble sub-

units. Some proteins can be solubilized by highly acidic solutions. A detergent containing a proteolytic enzyme may be used effectively in removing protein. Depending upon the type of protease (acid or alkaline), these formulations are in the pH range of 5–9. Hydrogen peroxide may be added as a booster for removing proteins; however, it is much slower in action and not as effective as chlorine.

3. Carbohydrates

Carbohydrates of low molecular weight are easily soluble in water and do not require special treatment. However, if they are burned on a hot surface (caramelized) or are present as higher polysaccharides, oxidizing agents are needed to break the molecules into smaller, more soluble components. Such oxidizers may be hypochlorite-based products or oxygen-releasing compounds such as perborate, percarbonate, and hydrogen peroxide. The choice will depend on cleaning conditions and materials involved.

The carbohydrates more difficult to clean from an equipment surface are polysaccharides such as starches. When starches are processed at elevated temperatures, they may become gelatinous and thus difficult to remove. If this condition exists, an acid cleaner may be a better choice. Polysaccharides may also be hydrolyzed by specific enzymes such as amylase or other carbohydrases depending upon soil composition.

4. Mineral Salts

Mineral salt deposits accumulate by precipitation from water, food, or a combination of both. For example, the calcium content of milk products and water hardness can form adherent white deposits known as milkstone. Milkstone is composed of these food-mineral deposits and can be effectively removed by acids. Iron and manganese present in water are objectionable and may be responsible for colored deposits ranging from black-brown to purple. Periodic acid washes or rinses are typically used after an alkaline wash to control mineral deposits. In less severe instances, these salt deposits can be dissolved by use of alkaline cleaners containing chelating or sequestering agents.

5. Other Soils

Other soils that may be found in dairy equipment are the food additive titanium dioxide and materials found in water such as clay or sand. These are inert materials, not soluble in either acids or alkaline products, but may be removed from equipment by erosion and turbulence generated by a rapid flow; newer cleaning compositions utilizing peracids and surfactants are being used in this application. Burned food soils that are charred, polymerized, caramelized, or carbonized can be removed from equipment with strongly formulated alkaline cleaners used at

high temperatures and requiring longer times to be effective. Also, equipment that is exposed to strong caustic detergent and high temperature may develop darkening of stainless steel surfaces, which is impossible to eliminate with conventional cleaners. Products are available which restore the surface to the original appearance of stainless steel.

6. Water

Water is the most important ingredient in cleaning and sanitizing solutions. The food and dairy industries require large quantities of high-quality water for direct addition to foods and beverages as well as for cleaning and sanitizing. Some waters must undergo treatment processes to minimize or eliminate impurities (Table 1) before being used in food and dairy processing plants. Typical objectionable components of water include water hardness/minerals, microorganisms, and other impurities. Some of these impurities may adversely affect cleaners and sanitizers and must be eliminated or reduced to acceptable levels (Table 2).

a. Water Hardness More than any other chemical property of water, hardness directly affects cleaning and sanitizing. It may affect performance and consumption of a cleaner or sanitizer. Poor water quality may also lead to formation of films or deposits.

Water hardness exists in two different forms: temporary and permanent. Temporary hardness occurs when calcium and magnesium ions exist in water as bicarbonates. They are soluble and when heated will form carbonates and precipitate. When calcium and magnesium ions appear as chloride, nitrate, or sulfate salts, permanent hardness results. These salts are soluble and are not affected by changes

Table 1 Typical Impurities in Water

Component	Chemical formula	Problem caused
Barium sulfate	BaSO ₄	Scale
Carbon dioxide	CO ₂	Corrosion
Calcium bicarbonate	Ca (HCO ₃)	Scale and corrosion
Calcium sulfate	CaSO ₄	Scale and corrosion
Iron	Fe	Scale
Magnesium bicarbonate	Mg(HCO ₃) ₂	Scale
Magnesium chloride	MgCl ₂	Scale and corrosion
Magnesium sulfate	MgSO ₄	Scale and corrosion
Oxygen	O ₂	Corrosion
Sodium chloride	NaCl	Corrosion
Silica	Si	Scale
Suspended solids	—	Deposition and corrosion

Table 2 Suggested Standards for Water Used in Cleaning/Sanitizing Applications

Factor	Specification (mg/L)
Turbidity	1–10
Color	5–10
Taste/odor	Low
Total dissolved solids	500
Hardness as CaCO ₃	250
Alkalinity as CaCO ₃	250
pH	6–8
Iron	0.3
Manganese	0.1
Copper	2
Chlorides	200
Sulfates	200
Silica	15
Microorganisms	Pathogen free
Standard plate count	Less than 500 cfu/mL
Coliforms	Less than 1 cfu/100 mL
Psychrotrophs	Less than 10 cfu/mL

in temperature. Minerals causing both temporary or permanent hardness will precipitate in alkaline systems without water conditioners. Mineral salts causing temporary hardness change to carbonates and precipitate, whereas salts causing permanent hardness, in the presence of carbonates or hydroxides, will also precipitate. Water hardness is expressed in either grains per gallon or parts per million (Table 3).

Many of today's detergents can perform well at high water hardness. In very hard water, high concentrations of cleaners or additives must be used to compensate for the hardness. In some instances, mechanical softening of plant water may be more economical.

Table 3 Water Hardness

Hardness	Grain per gallon (gpg)	ppm
Soft	0–3.5	0–60
Moderately hard	3.5–7.0	60–120
Hard	7.0–10.5	120–180
Very hard	Over 10.5	Over 180

17.1 ppm = 1 gpg.

b. pH The pH of natural water varies depending on geographical location. The normal pH of water ranges from 6.5 to 8.5. Waters outside of this range may need treatment if they adversely affect operations in the plant. Some sanitizing solutions are affected by water with high acidity or alkalinity and will exhibit lower antimicrobial activity.

c. Microorganisms Waters can contain diverse types of microorganisms and may require pretreatment to conform to the U.S. Public Health Service Standards for potable or drinking water. The water must be free of pathogenic organisms as indicated by coliform levels of less than 1 cfu (colony forming unit)/100 mL of water. The total plate count in potable water is usually less than 1000/mL. Higher levels may be indicative of serious contamination.

Although potable water may be free of pathogenic organisms, it may contain spoilage organisms that can affect the shelf life of food products. For production of high-quality products in dairy processing plants, the total plate count of processing water should not exceed 10 cfu/mL. For postrinsing, coliform counts of the water should be less than 1 cfu/100 mL and psychrotrophic counts should be less than 10 cfu/mL. For direct product or process use, the level of psychrotrophic bacteria should be less than 1 cfu/mL.

B. Surfaces

Selection of a cleaner depends on several factors, but materials used to construct equipment are an important consideration. Today food and dairy equipment is primarily constructed of stainless steel, which has many advantages including being resistant to chemical attack. Polished 304 or 316 stainless steel permits use of some cleaning chemicals not recommended for other metals such as aluminum, zinc, and tin. When the dry metal surface of stainless steel is exposed to air, it forms an oxide film that protects the surface from corrosion. Surfaces, after cleaning and sanitizing, should be allowed to dry to restore this protective film.

Some plastic and glass materials are being used for lining of tanks and lines. Some of the plastics include polyethylene, polypropylene, polycarbonate, and polyvinylidene fluoride. These materials vary in their resistance to chemical attack by cleaning agents. The manufacturer of the chemical should be consulted as to compatibility of its products with these materials.

C. The Cleaning Equation

Four interrelated factors affect the efficiency of the cleaning process. They are (a) concentration of cleaning agent, (b) water temperature, (c) time required, and (d) amount of mechanical action.

These four factors can be adjusted according to specific situations or needs. For example, when an employee washes equipment manually, water tempera-

ture must be low enough to avoid burning skin or causing discomfort. In this instance increased mechanical action compensates for the lower temperature. In cleaning in place (CIP) systems, mechanical action is limited to turbulent flow, and thus a more aggressive cleaning compound is needed to deliver acceptable results.

1. Hand or Manual Cleaning

Using this method, parts or utensils are rinsed with water and then brushed with detergent solution in a bucket or sink to remove soil residues. The temperature of the cleaning solution should not exceed 50°C, and the pH should be in the range of 4.0–10.5 to ensure the safety of the operator during manual application. To avoid irritation to skin and eyes, use of suitable gloves and eye protection is recommended.

2. Spray or High-Pressure Cleaning

In high-pressure, low-volume cleaning operations, the effect of physical force is used as an important cleaning component. This allows for reduced chemical usage both in terms of volume and concentration. If spraying is done in an open space, all employees should be protected by safety equipment from exposure to the cleaner because of misting and atomization in the area. When using this method of cleaning, care must be taken not to distribute soils to previously cleaned areas.

3. Foam, Gel, and Thin-Film Cleaning

A safer and more effective way to clean equipment is to use foam, gel, or thin-film methods. Foam, gel, or a thin film can be generated via a portable or centralized foam unit which combines air pressure and water with a foaming detergent to generate a stable foam or gel. This method of cleaning maximizes contact time in the four-parameter cleaning equation. The exterior of processing equipment, walls, and ceilings are covered with stable foam that adheres to outer surfaces for 5–10 min. When the surface is still wet, it should be rinsed off with warm water. A gel cleaner is more viscous. It adheres to vertical surfaces longer than a foam cleaner, and then is rinsed with warm water. Thin film, on the other hand, is a less viscous mixture and when applied to vertical surfaces it clings like a gel, leaving only a thin film that stays wet and active up to 30 min or longer. When compared to gel cleaner, it uses less product, less application time, and smaller quantities of rinse water.

Gels or thin films should be applied from the bottom of the equipment to the top and rinsed from top to bottom. Foam should be applied from top to bottom

of the area to be cleaned and rinsed from top to bottom. Use of foam, gel, or thin-film cleaners replaces the potentially unsafe misting of detergent, especially in an open area. These types of cleaners are generally formulated with less aggressive chemicals and mechanical energy is minimized.

4. Cleaning Out of Place

In cleaning out of place (COP) systems, disassembled parts and utensils are placed in the recirculation parts washer equipped with circulation pump and distribution headers that agitate cleaning solutions. Initially, parts are rinsed and then the cleaning solution is circulated, providing some agitation necessary for soil removal. Parts are subsequently rinsed and sanitized.

5. Cleaning in Place

In the dairy industry, most equipment is cleaned in place (CIP). This means detergent and sanitizer are delivered to the equipment without disassembly. The CIP unit is designed to recirculate detergents, rinses, and sanitizing solutions for tanks, silos, vats, pasteurizers, sterilizers, and their pipelines. It is usually automated for time, temperature, detergent concentration, and volume of water. All pipelines must be installed with at least a 1/8 in/ft incline to allow good drainage. Also, velocity of the cleaning solution through the pipeline should be at least 5 ft/s, and flow rate of the cleaning solution should be greater than that of the product. CIP systems may be divided into two basic types: a reclaim system where detergent solution is saved and concentration readjusted each time before the next cleaning and a single-usage system where the detergent is used only once. There are four or five steps in the CIP cleaning cycle: (a) prerinse with water, (b) alkaline wash, (c) postrinse, (d) acid wash or rinse (optional), and (e) sanitizing rinse. Circulation time, temperature, and concentration of detergent have to be synchronized to get optimum cleaning and sanitizing results.

In single-phase cleaning, either the alkaline or acid wash is eliminated. These products are formulated to deliver the same result as the combined effect of alkaline plus acid steps. In addition to good cleaning results, some other advantages of single-phase cleaners are savings in time, water, energy, and effluent costs. Saving in chemicals is accomplished by eliminating either the acid or alkaline cycle. Solutions are sometimes reused and require more adjustments because of the complexity of the formulation.

In the override system of CIP cleaning, a hot acid-containing surfactant solution is circulated through equipment and is returned to the make-up tank. Subsequently, alkali is added to the acid solution, and the hot mixture is recirculated. The only saving gained in this method is elimination of intermediate water

rinses used between alkaline and acid cleaning. This type of cleaning is sometimes used in HTST units and vacuum pans.

D. Environmental Factors

Dairy plants generate relatively high levels of wastewater because of (a) frequency of cleaning and (b) extensive surface area to be cleaned. The milk soil can contribute a fairly significant BOD (Biochemical Oxygen Demand) load, and the classic cleaning processes create wastes of pH as high as 12 or as low as 2. Many municipalities will not accept wastes of this nature, and therefore on-site neutralization processes are employed. In some instances, limits are set on other detergent compounds such as phosphate, nitrate, for ultimate biodegradability.

III. DETERGENT INGREDIENTS

Detergents employed in commercial dairy cleaning formulations contain a broad range of chemical compounds. These cleaning compounds may be divided into the following general categories: (a) surfactants, (b) builders (alkaline builders, acid builders, enzymes, water conditioners, oxidizing agents), (c) fillers, and (d) miscellaneous additives

A. Surfactants

Surfactants are organic compounds that play a very important role in the cleaning process. These molecules are composed of a hydrophilic and hydrophobic moiety. The balance between hydrophilic and lipophilic (hydrophobic) groups is called HLB (hydrophilic-lipophilic balance). Surfactants lower surface tension and are good wetting, penetrating, emulsifying, solubilizing, and dispersing agents. All of these properties of surfactants are actively involved in removal of soils from equipment surfaces. When incorporated into cleaning solutions, they enable the solution to enter into pores, cracks, and crevices, penetrate soil, emulsify soil, and disperse soil into the solution. Several different types of surfactants are employed in cleaning solutions (Table 4).

Anionic surfactants are good detergents, wetting agents, solubilizing, dispersing agents, and foamers. Water hardness and the presence of cationics adversely affects their performance.

Cationic surfactants are not recognized as being particularly good emulsifying or dispersing agents. They are adversely affected by water hardness and will react with anionic surfactants.

Table 4 Surfactants Employed in Cleaning Solutions

Class	Description	Examples
Anionics	Ionize in solution to give an active negative ion	Alkyl sulfonates Alkylaryl sulfonates Alkyl ether sulfates Alkyl sulfates Phosphoric acid esters
Cationics	Ionize solution to give an active positive ion	Quaternary ammonium compounds Alkyl amines Ethoxylated amines Alkyl betaines
Nonionics	No charge in solution	Alkylphenol ethoxylates Alcohol ethoxylates Ethylene oxide/propylene oxide polymers
Amphoterics	Have both positive and negative charge depending upon pH	Acylamino acids N-alkyl amino acids

Nonionic surfactants are stable in the presence of hard water. They are effective over a wide pH range. Nonionic surfactants are good emulsifiers, powerful surface-tension reducers, and good foamers and defoamers. The use of a nonionic surfactant as a defoamer is dependent on temperature and cloud point, which is defined as that temperature at or near which nonionics begin to become insoluble in a heated solution causing a cloudy or turbid appearance. Below the cloud point temperature, they are foamers, but above they are defoamers. Low-foaming nonionic surfactants also exhibit good rinsing properties.

Amphoterics surfactants behave either as cationic or anionic surfactants depending on the pH. They have the advantage of being compatible with either cationic or anionic surfactants. These compounds have emulsifying, foaming, solubilizing, and lime-dispersing capabilities and are resistant to water hardness.

B. Builders

In addition to surfactants, builders also contribute to the actual cleaning power in a detergent. There are five generally recognized classes of builders: (a) alkaline builders, (b) acid builders, (c) enzymes, (d) water conditioners, and (e) oxidizers.

1. Alkaline Builders

Alkaline builders constitute the bulk of all detergents used on food and dairy processing equipment, because they most effectively remove all food soils such as fats, proteins, and carbohydrates. They contribute electrons or negative ions that surround soils and disrupt their structure, swell them, and free them from surfaces. Alkaline builders include sodium hydroxide, potassium hydroxide, sodium (potassium) metasilicate (silicate), sodium carbonate, and some phosphates (trisodium phosphate) (Table 5).

Alkalinity consists of two parts, active alkalinity and inactive alkalinity, and together they comprise total alkalinity. Active alkalinity titrates to pH 8.4 or to the phenolphthalein endpoint, whereas inactive alkalinity titrates from pH 8.4–3.4 or to the methyl orange endpoint. Active alkalinity is the alkalinity responsible for the actual cleaning action of alkaline products. If the cleaning solution is reused, active alkalinity must be monitored and upgraded to the desired concentration for the cleaning solution to be effective in the new cleaning cycle.

2. Acid Builders

Acid detergents can be very effective in solutions where soils fail to respond to alkaline cleaners. Because of corrosion and safety concerns associated with strong mineral acids such as hydrochloric acid, milder acids or acid combinations are usually selected for use on dairy equipment. For many years, acids have been employed as milkstone (calcium phosphate) removers in the dairy industry. In addition, acids have been extensively used in the dairy plant sanitation program, especially for cleaning high-temperature processing equipment such as HTST pasteurizers, evaporators, UHT units, as well as in CIP cleaning of other milk processing and storage equipment. Applications of acid maintain the equipment surface free of mineral (water hardness) deposits and keep stainless steel in good condition. Often acids are used as acidified rinses to ensure neutralization of alkaline residues that may be left on equipment after insufficient rinsing of the alkaline cleaner.

The most widely used acids in the food and dairy industries are phosphoric, nitric, sulfamic, citric, lactic, and hydroxyacetic (Table 6). Because inorganic acids are more aggressive, they are better cleaners, more corrosive, and more economical, whereas organic acids are safer and less aggressive but more expensive to use. These acids are used alone or in combinations, and for best results, they are often formulated with corrosion inhibitors and surfactants. By removing mineral deposits, sites for bacterial attachment are minimized.

3. Enzymes

Enzymes are employed as detergent additives where less corrosive formulations are desired. They are often used when effluent restrictions on very high or low

Table 5 Typical Alkaline Builders

Ingredients	Comparative ability									
	Saponification	Emulsification	Protein control	Penetration	Suspension	Water conditioning	Rinsability	Foam	Noncorrosive	Nonirritating
Basic alkalis										
Sodium or potassium hydroxide	A	C	B	C	C	D	D	C	D	DD
Silicates	C	B	C	C	B	D	D	C	A	D
Carbonates	C	C	C	C	C	D	C	C	C	C
TriSodium phosphate	C	B	C	C	B	C	A	C	C	D
Complex phosphates										
Tetrasodium pyrophosphate	C	B	C	C	B	B	A	C	A	A
Sodium tripoly phosphate	C	A	C	C	A	AA	A	C	A	A
Sodium polyphosphate	C	A	C	C	A	AA	A	C	A	A
Gluconates	C	C	C	C	B	B	B	C	A	A
Organic materials										
EDTA	C	C	C	C	C	AA	C	C	B	A
Phosphonates	C	B	C	C	C-B	AA	C	C	A	A
Polyelectrolytes	C	B	C	C	B	A	B	C	A	A
Wetting Agents	C	AA	C	AA	AA	C	AA	D-A	A	A
Protease Enzymes	C	C	AA	C	C	C	C	C	A	D

A, excellent; B, good; C, no/minor contribution; D, negative performance

Table 6 Acid Detergents

Ingredients	Comparative Ability									
	Mineral/scale removal	Emulsification	Penetration	Suspension	Rinsability	Foam	Noncorrosive stainless steel	Noncorrosive soft metals	Nonirritating	Passivation
Mineral Acids										
Muriatic (hydrochloric)	AA	C	C	C	C	C	DD	DDD	DD	DD
Sulfuric	AA	C	C	C	C	C	DD	DDD	DD	DD
Sulfamic	A	C	C	C	C	C	B	D	C	C
Nitric	A	C	C	C	C	C	A	DDD	DD	AA
Phosphoric	A	C	C	C	C	C	A	DD	C	A
Organic Acids										
Citric	B	C	C	C	C	C	A	D	B	A
Hydroxyacetic	B	C	C	C	C	C	A	D	B	B
Glycolic	B	C	C	C	C	C	A	D	A	C
Wetting Agents										
Nonionic						D				
Anionic						A				

A, excellent; B, good; C, no/minor contribution; D, negative performance.

pH are in effect. The most widely used enzymes are proteases. In recent years, commercial products containing proteolytic enzymes have been used as replacements for chlorinated alkaline cleaners. In these applications, the enzyme replaces hydrolytic activity of the chlorine/high alkalinity system. Use of other enzymes such as lipase and carbohydrases is less common.

Although enzymes present an environmentally favorable profile, worker exposure through aerosolization must be avoided because of the potential for allergic reaction. Enzyme-containing detergents are therefore not recommended in open-spraying or manual cleaning operations.

4. Water Conditioners

Water conditioners represent a very important group of builders that considerably enhance cleaning performance of alkaline and neutral cleaners with their desirable properties. These builders when incorporated into cleaners react with calcium, magnesium, or other ions present in soil or in hard water and greatly aid in the soil-removal process. Water conditioners may be placed into the following groups:

1. *Inorganic phosphates*. These compounds include sodium tripolyphosphate, tetrasodium and tetrapotassium pyrophosphates, sodium hexametaphosphate, trisodium phosphate, and orthophosphates. These polyphosphates form soluble undissociated complexes with metallic ions such as calcium, magnesium, iron, and copper and prevent them from precipitating. In addition to being good sequestering agents, they also exhibit good buffering and deflocculation properties, as well as enhance overall cleaning efficiency of the formulated product. Trisodium phosphate, higher in alkalinity than other phosphates, is also a saponifier and emulsifier of oily soils. Another characteristic property of phosphates is their ability to treat hard water at very low concentrations. This so-called “threshold effect” utilizes minute levels of 10–20 ppm of phosphate to treat hard water and prevent minerals from precipitating. Although the cleaning solution will be cloudy, minerals will not precipitate and can be rinsed freely from equipment surfaces. Orthophosphates such as monosodium- and disodium phosphate are inorganic phosphates and usually serve as fillers. There are several disadvantages of polyphosphates: (a) at high temperatures, they revert to orthophosphates, (b) they are undesirable in the effluent and need special treatment for disposal, and (c) they are rather expensive to use.
2. *Organic phosphonates*. Three known liquid builders that are used in dairy cleaners are: (a) nitrilomethylene phosphonate, (b) hydroxyethanediphosphonate, and (c) 2-phosphonobutane-1,2,4-tricarboxylate.

- They are effective sequestering agents, prevent scale formation, and provide corrosion inhibition in aqueous systems.
3. *Polyelectrolytes*. These compounds include polyacrylates and other polycarboxylic acids. These organic compounds were developed as replacements for phosphates. They are good soil removers and soil dispersants, water conditioners, and anti-soil redeposition agents.
 4. *Chelating agents*. Ethylene diamine tetraacetic acid (EDTA) and its disodium, trisodium, and tetrasodium salts; diethylene-triamine pentaacetic acid (DTPA), pentasodium salt; N-(hydroxyethyl) ethylene diamine triacetate (HEEDTA); nitrilotriacetic acid (NTA), and trisodium salt are organic compounds with higher sequestering power than complex phosphates. They are stable at different pH values and temperatures. They are effective in preventing and dissolving scale and lime deposits, removing water hardness and other metal ions by forming soluble complexes, and keeping the detergent solution clear.
 5. *Salts of organic acids*. Gluconic, citric, and glucoheptonic acids are also used to sequester calcium and iron. Sodium gluconate is a good additive for caustic soda in a bottle-washing application. Some formulators suggest that mixtures of sodium glucoheptonate or sodium citrate with sodium gluconate may provide better overall cleaning results. Citric acid and sodium citrate are also good sequestering and buffering agents that are present in some food and dairy cleaners.

5. Oxidizers

Chlorinated compounds, such as sodium or potassium hypochlorite at 50–100 ppm levels can be added to cleaning solutions to assist in protein removal. This cleaning enhancement in alkaline systems by chlorine is frequently used in dairies and on dairy farms. Active chlorine is a strong oxidizing agent and it reacts with polymeric soils in the oxidation-reduction process by breaking them down. Similarly, in removal of starches, chlorine addition is helpful in the degradation process of the compound. Corrosion to metals is a disadvantage of using chlorine at high temperatures in alkaline systems over a prolonged time. Hydrogen peroxide is not as corrosive as chlorine and is sometimes used as a cleaning booster in similar applications. It is not as effective as chlorine and must be used at higher concentrations. Hydrogen peroxide is not as corrosive as chlorine. Sodium perborate is sometimes added as an oxygen donor to detergents to boost cleaning efficiency.

C. Fillers

Several ingredients that are present in a typical detergent formula serve as fillers. Some of the fillers in dry products include sodium chloride, sodium sulfate, and

sodium hydroxide. Quite often during formulation, fillers are also used to dilute a concentrated product for safer handling.

D. Miscellaneous Ingredients

There are several different ingredients that can be added to a formulation such as preservatives, corrosion inhibitors, dyes, pigments, thickeners, antioxidants, indicators, and solvents. Generally, products intended for use in food or dairy plants may contain corrosion inhibitors to protect metals from aggressive acids, and frequently a dye is incorporated into liquid product for differentiation. If a liquid formulation is susceptible to biological deterioration, a preservative or biocide may be added. Also, solvents such as glycol ethers may be added to a liquid cleaner to improve removal of grease and oils from surfaces. If a thicker product is required, a thickening agent is added to the formulation.

IV. CLEANING PROCEDURES

In most applications, the detergent is preceded by a water rinse to remove most soils. Cleaning practices around the world may vary considerably owing to factors such as regulations, environmental issues, and economics. Cleaning processes typically used for various types of equipment from dairy farms through processing are described in Tables 7–11.

Table 7 Cleaning and Sanitizing of Dairy Equipment—Dairy Farms

	Problem soil	Application method	Procedure
Milking equipment Inflation and claw assembly	Raw milk	COP	Mildly alkaline detergent w/sanitizing step
Pipeline	Raw milk	CIP	Chlorinated alkaline single-phase cleaner w/sanitizing step ^a Enzyme cleaner w/sanitizing steps
Bulk tank	Raw milk	CIP	Chlorinated alkaline single-phase cleaner w/sanitizing step ^a Enzyme cleaner w/sanitizing steps

^a May require acid cleaning once per week.

Table 8 Cleaning and Sanitizing of Dairy Equipment—Raw Milk

Equipment	Soil	Application Method	Procedure
Tankers	Thin layers of proteins and hard water deposits	CIP	Chlorinated alkaline single phase cleaners w/sanitizing step ^a Enzymatic cleaner w/sanitizing step ^a
Receiving	Thin layers of proteins and hard water deposits	CIP	Chlorinated alkaline single phase cleaners w/sanitizing step ^a Enzymatic cleaner w/sanitizing step ^a
Raw milk storage	Thin layers of proteins and hard water deposits	CIP	Chlorinated alkaline single phase cleaners w/sanitizing step ^a Enzymatic cleaner w/sanitizing step ^a
Separator	Thick layers of proteins, fat and milkstone	CIP	Dual-phase cleaning Alkaline followed by acid rinse and a sanitizing step Override cleaning Acid cleaner followed by an alkaline cleaner and a sanitizer step
Homogenizer	Thick layers of proteins, fat and milkstone	CIP	Dual-phase cleaning Alkaline followed by acid rinse and a sanitizing step Override cleaning Acid cleaner followed by an alkaline cleaner and a sanitizer step
External surfaces of equipment	Proteins, fat, dust, and water deposits	Foam/gel/thin film	Chlorinated alkaline single-phase cleaners w/sanitizing step ^a

^a May require acid cleaning once per week.

Table 9 Cleaning and Sanitizing of Dairy Equipment—Pasteurized Milk

Equipment	Soil	Application method	Procedure
HTST pasteurizer	Thick layers of fat, protein, and milkstone	CIP	Dual-phase cleaning Alkaline followed by acid rinse and a sanitizing step Override cleaning Acid cleaner followed by an alkaline cleaner and a sanitizer step
Pasteurized milk storage tank	Thin layers of protein	CIP	Chlorinated alkaline single-phase cleaners with sanitizing step ^a Enzymatic cleaner with sanitizing step ^a
Filling equipment	Thin layers of proteins and hard water deposits	CIP	Chlorinated alkaline single-phase cleaners with sanitizing step ^a Enzymatic cleaner with sanitizing step ^a
External surfaces of equipment	Proteins, fats, dust, and water deposits	Foam/gel/ thin film	Chlorinated alkaline single-phase cleaners with sanitizing step ^a Enzymatic cleaner with sanitizing step ^a

^a May require periodic acid cleaning.

V. SANITIZERS

There are several reasons why we clean and sanitize food and dairy processing equipment. Cleaning is only the first step to good sanitation. Most cleaning operations are insufficient in totally eliminating microorganisms from the processing equipment. Thus, the use of efficient sanitizers is required to ensure a surface which is substantially free of microorganisms.

A. Governmental Regulations

The Environmental Protection Agency (EPA) through its Office of Pesticide Programs (OPP) regulates pesticide products. In the United States, all sanitizers are classified as pesticides and must be registered. The Federal Insecticide, Fungicide and Rodenticide Act (FIFRA) of 1947 and more recently the Federal Pesticide

Table 10 Cleaning and Sanitizing of Dairy Equipment—Cheese Production

	Soil	Application method	Procedure
Starter tank	Thick layers of fat, protein, and milkstone	CIP	Dual-phase cleaning Alkaline followed by acid rinse and a sanitizing step Override cleaning Acid cleaner followed by an alkaline cleaner and a sanitizer step
Cheese vats	Thick layers of fat, protein, and milkstone	CIP	Dual-phase cleaning Alkaline followed by acid rinse and a sanitizing step Override cleaning Acid cleaner followed by an alkaline cleaner and a sanitizer step
Preprocessing vat	Thick layers of fat, protein, and milkstone	CIP	Dual-phase cleaning Alkaline followed by acid rinse and a sanitizing step Override cleaning Acid cleaner followed by an alkaline cleaner and a sanitizer step
Cheddaring machine	Thick layers of fat, protein, and milkstone	CIP	Dual-phase cleaning Alkaline followed by acid rinse and a sanitizing step Override cleaning Acid cleaner followed by an alkaline cleaner and a sanitizer step
Curd milling and salting system	Thick layers of protein, fat, milkstone, and salt	CIP	Dual-phase cleaning Alkaline followed by acid rinse and a sanitizing step Override cleaning Acid cleaner followed by an alkaline cleaner and a sanitizer step

Table 11 Cleaning and Sanitizing of Dairy Equipment—By-Product and Further Processing

	Soil	Application method	Procedure
Whey evaporator	Coagulated/ denatured protein Calcium phosphate stone	CIP	Acid prewash (recovered from previous cleaning) 2% hot acid wash Acid sanitizing
Milk evaporator	Denatured protein Calcium deposits Lipids	CIP	Caustic prewash (recovered solution) 2% hot acid wash 1% hot acid wash or rinse Acid sanitizing
Spray dryers	Whey or milk solids	CIP	Caustic prewash (recovered solution) 3–4% hot caustic wash 1–2% hot acid wash Acid sanitizing
HTST	Denatured protein Calcium deposits Lipids	CIP	Caustic prewash (recovered solution) 1.5% hot caustic wash 1% hot acid wash
UHT	Denatured protein Calcium deposits Lipids	CIP	Caustic prewash (recovered solution) 2–4% hot caustic wash 1–2% hot acid wash

Notes: Some whey evaporators concentrate predenatured (hot-well) whey. Cleaning program then becomes same as milk evaporator.

Evaporator detergent concentrations are in-let concentrations. Evaporators are cleaned under vacuum. Detergent concentration will gradually increase as water is removed.

Detergent temperatures are typically 82°C or higher. Times are typically 60 min for alkaline wash and 30 min for acid wash if used together, or 60 min for a single, primary acid wash. Sanitizers are once through and discard. Cleaning programs are currently trending from time to cycles. One cycle being one complete circuit through equipment being cleaned. Caustic washes typically recycle four to five times (or single, primary acid washes) and secondary acid washes recycle two to three times. HTST and UHT systems are periodically cleaned by one or several miniwashes or mid-washes to remove gross soils and maintain efficiency of heat transfer surfaces. These consist of 10–15 min caustic wash or flush which is then discarded.

Control Act of 1972 are the basic laws requiring that such products be registered. No-rinse sanitizers are considered to be indirect food additives and up until 1996 required FDA approval. With passage of the Food Quality Protection Act of 1996, this responsibility was transferred to the EPA. For this purpose, a new Antimicrobial Division was formed at the EPA to handle only antimicrobial product applications and functions.

There are currently over 40 compositions approved for use on food contact surfaces without a water rinse (Table 12). (FDA, 1999)

B. Definition of Key Terms

It may be practical to start the review of sanitation and sanitizers by defining the terms that will be used frequently in the following pages of this chapter:

Antiseptic. An agent that frees from infection by killing harmful microorganisms on living tissues of the human or animal body.

Bactericide. An agent that kills bacteria.

Bacteriostat. An agent that inhibits growth of bacteria in the presence of moisture and may or may not affect viability of bacterial cells.

Biocide. An agent that kills bacteria, fungi, or viruses.

Detergent-sanitizer. A product that possesses the properties of a cleaner and sanitizer.

Disinfectant. An agent that frees from infection by destroying harmful microorganisms on inanimate surfaces.

Fungicide. An agent that kills yeasts and molds (fungi).

Fungistat. An agent that inhibits growth of yeasts and molds.

Germicide. An agent that kills germs that may be pathogenic.

Sanitation. The establishment of environmental conditions favorable to health.

Sanitizer. An agent that reduces the microbial contaminants to safe levels as determined by the EPA requirements. It is commonly used on inanimate surfaces.

Sterilant. An agent that kills all forms of vegetative bacteria, bacterial spores, fungi, and viruses.

Virucide. An agent which kills viruses.

C. Importance of Label Directions

An EPA label provides very important information to the user. Therefore, it is imperative for an initial user to read the label contents. From an approved EPA sanitizer label, the user can learn several important facts: (a) warnings and precautionary statements, (b) identity of active ingredient and its percentage, (c) state-

Table 12 Approved Sanitizing Solutions

Active ingredient(s) ^a	Use solution levels
b1 Potassium, sodium, calcium hypochlorites	max 200 ppm available chlorine
b2 Ditrichloroisocyanuric acids or sodium, potassium salts	max 100 ppm available chlorine
b3 Potassium iodide/iodine	max 25 ppm titratable iodine
b4 Iodine-surfactant complex	max 25 ppm titratable iodine
b5 Iodine-surfactant complex	max 25 ppm titratable iodine
b6 Iodine-surfactant complex	max 25 ppm titratable iodine
b7 Dodecylbenzene sulfonic acid (DDBSA)	max 400 ppm
b8 Iodine-surfactant complex	max 25 ppm titratable iodine
b9 n-alkyl _{C12-C18} Benzyl dimethylammoniumchlorides	max 200 ppm active quaternary
b10 Trichloromelamine and dodecylbenzene sulfonic acid	max 200 ppm available chlorine
b11 n-alkyl _{C12-C18} Benzyl dimethylammonium chlorides and n-alkyl _{C12-C18} dimethyl ethylbenzylammonium chlorides	max 400 ppm max 200 ppm total active quaternary
b12 Sodium salt of sulfonated oleic acid	max 200 ppm sulfonated oleic
b13 Iodine-polyglycol complex	max 25 ppm titratable iodine
b14 Iodine-surfactant complex	max 25 ppm titratable iodine
b15 Lithium hypochlorite	max 200 ppm available chlorine
b16 n-alkyl _{C12-C18} Benzyl dimethylammonium chlorides, and n-alkyl _{C12-C14} dimethyl ethylbenzylammonium chlorides	max 200 ppm total active quaternary
b17 di-n-alkyl _{C8-C10} Dimethylammonium chlorides	max 150 ppm active quaternary
b18 n-alkyl _{C12-C18} Benzyl dimethylammonium chlorides	max 200 ppm active quaternary
b19 Sodium dichloroisocyanurate	100 ppm available chlorine
b20 Ortho-phenolphanol, ortho-benzyl-para-chlorophenol, and	400 ppm active
para-tertiaryamyl phenol	320 ppm active
	80 ppm active

b21	Sodium dodecylbenzenesulfonate (SDDBS)	max 430 ppm: min 25 ppm
b22	di-n-alkyl _{C8-C10} Dimethylammonium chlorides and n-alkyl _{C12-C18} benzyl dimethylammonium chlorides	max 400 ppm: min 150 ppm total active quaternary
b23	n-alkyl _{C12-C16} Benzyl dimethylammonium chlorides and dodecyl dimethylammonium chloride	max 200 ppm: min 150 ppm total active quaternary
b24	Iodine-surfactant complex	max 25 ppm: min 12.5 ppm titratable iodine
b25	Iodine-isopropanol solution	max 25 ppm: min 12.5 ppm titratable iodine
b26	(Reserved)	
b27	Octanoic acid and decanoic acid	max 218 ppm: min 109 ppm total active fatty acids
b28	Sulfonated 9-octadecenoic acid	max 312 ppm: min 156 ppm
b29	Sulfonated tall oil fatty acid and neo-decanoic acid	max 66 ppm: min 33 ppm max 174 ppm: min 87 ppm
b30	Hydrogen peroxide and peroxyacetic acid	max 1,100 ppm: min 550 ppm max 200 ppm: min 150 ppm
b31	Iodine-surfactant complex	max 25 ppm: min 12.5 ppm titratable iodine
b32	di-n-alkyl _{C8-C10} Dimethylammonium chlorides, and n-alkyl _{C12-C18} benzyl dimethylammonium chlorides	max 400 ppm: min 150 ppm total active quaternary
b33	di-n-alkyl _{C8-C10} Dimethylammonium chlorides, and n-alkyl _{C12-C18} benzyl dimethylammonium chlorides	max 400 ppm: min 150 ppm total active quaternary
b34	Mixture of oxychloro species (predominantly chlorite, chlorate, and chlorine dioxide)	max 200 ppm: min 100 ppm titrated as chlorine dioxide
b35	Octanoic acid and decanoic acid	max 234 ppm: min 117 ppm total active fatty acids
b36	Octanoic acid and decanoic acid	max 176 ppm: min 88 ppm max 58 ppm: min 29 ppm

b37	Sodium hypochlorite and potassium permanganate (potassium bromide optional)	max 200 ppm: min 100 ppm available halogen as chlorine
b38	Hydrogen peroxide and peroxyacetic acid	max 465 ppm: min 300 ppm max 315 ppm: min 200 ppm
b39	n-carboxylic _{C₆-C₁₂} Acid mixture	max 39 ppm: min 29 ppm mixture consisting of 56% C ₈ , 40% C ₁₀
b40	Iodine-surfactant complex and dodecylbenzene sulfonic acid	max 25 ppm: min 12.5 ppm titratable iodine max 5.5 ppm: min 2.7 ppm
b41	n-alkyl _{C₁₂-C₁₆} Benzyl dimethylammonium chlorides	max 200 ppm: min 150 ppm total active quaternary
b42	Nonanoic acid and decanoic acid	max 90 ppm: min 45 ppm max 90 ppm: min 45 ppm
b43	Iodine, hypochlorous acid, and iodine monochloride	max 25 ppm: min 12.5 ppm titratable halogen as iodine
b44	Sodium lauryl sulfate, and monosodium phosphate	max 350 ppm: min 175 ppm max 350 ppm: min 175 ppm
b45	Hydrogen peroxide, peroxyacetic acid, octanoic acid, and peroxyoctanoic acid	max 216 ppm: min 72 ppm max 138 ppm: min 46 ppm max 122 ppm: min 40 ppm of total octanoic and peroxyoctanoic acids
b46	Chlorine dioxide and related oxy-chloro species	max 200 ppm: min 100 ppm titrated as chlorine dioxide

Note: The table shows that seven general chemical classes comprise most antimicrobial agents used for sanitation in the dairy industry:

- acid-anionic surfactants
- carboxylic acids
- chlorine and chlorine compounds
- iodine complexes
- peroxide and peroxyacid mixtures
- phenolics

^a Quaternary ammonium compounds

Source: April 1, 1999 Code of Federal Regulations, title 21, part 170, section 178.1010, paragraph b, sub-paragraph references 1–46. Active ingredients listed are those considered by the chapter authors to be the major antimicrobial agents within each reference composition. Other component adjuvants may contribute to biocidal efficacy. Use solution levels are taken from same section, paragraph c, sub-paragraph references 1–40.

ment of “first aid” treatment, (d) statement on hazards to humans and domestic animals, (e) environmental hazards, (f) physical or chemical hazards, (g) storage and disposal, (h) directions for use, and (i) effectiveness against various organisms.

It is important that the user prepare the sanitizing solution accurately to ensure that the concentration is in the effective range for optimal results. The method of application should direct the user as to exposure time requirements. After the application, the user should either drain the sanitizer solution from equipment surfaces if it has clearance as an indirect food additive or rinse the equipment with potable water. In many countries, a potable water rinse is required after sanitizing. Although this avoids any issues with chemical residuals, the water can often reintroduce spoilage bacteria to the food contact surface. In the United States, sanitizing solution cannot be reused. In some countries, this procedure may be allowed. For manual operations, the user should start with fresh sanitizing solution prepared at least daily or more often if the solution becomes soiled or diluted.

1. Chlorine and Chlorine Compounds

a. Properties Several types of chlorine compounds are available (Table 13), with the hypochlorites being the most commonly used chlorine compounds in the dairy industry. Chlorine-based sanitizers form hypochlorous acid (HOCl) in solution. “Available” chlorine is a measurement of oxidizing capacity and is expressed in terms of the equivalent amount of elemental chlorine. In general, the organochlorines are slower acting bactericides than inorganic forms, but they offer the advantage of stability and are relatively less irritating to personnel and less corrosive to equipment.

The chemistry of chlorine in solutions, whether the source is elemental chlorine, hypochlorites, or organochlorines, can basically be described as follows:

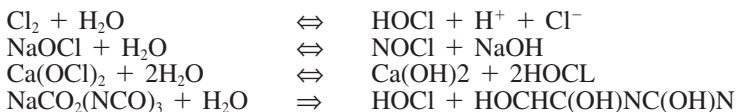

The term *free available chlorine* is usually applied to the three forms of chlorine that may be present in water. These forms are (a) elemental chlorine (Cl_2), (b) hypochlorous acid (HOCl), and (c) hypochlorite (OCl^-). At pH 4–5, most of the chlorine is in the HOCl form. As the pH is decreased below 4, increasing amounts of Cl_2 are formed. Above pH 5, OCl^- proportions increase. Table 14 illustrates the relative percentages of the HOCl species present over a wide pH range. Hypochlorous acid is the most bactericidal species of the three; how-

Table 13 Characteristics of Chlorinated Compounds

Name	Chemical formula	Chemical abstracts registry no.	Typical maximum water solubility at 20°C (%)
Gaseous chlorine	Cl ₂	7782-50-5	0.7 ^a
Hypochlorous acid	HOCl	7790-92-3	16 Maximum
Sodium hypochlorite	NaOCl	56802-99-4	50 Maximum
Chlorinated trisodium phosphate	Na ₃ PO ₄ ·12H ₂ O- 1/4NaOCl	56802-99-4	18
Calcium hypochlorite	Ca(OCl) ₂	7778-54-3	60 Maximum
Potassium hypochlorite	KOCl	7778-66-7	45
Chloramine-T	C ₇ H ₇ ClNNaO ₂ S	473-34-7	15
Dichlorodimethyl-hydantoin	C ₃ H ₆ Cl ₂ N ₂ O ₂	1118-52-5	0.2
Trichloro(iso)cyanuric acid	Cl ₃ (NCO) ₃	87-90-1	1.2
Sodium dichloro(iso)cyanuric acid	NaCl ₂ (NCO) ₃	2893-78-9	25
Chlorine dioxide	ClO ₂	11049-04-4	1

^a As total of (Cl₂ + HOCl + Cl) moieties.

Source: Corda and Dychdala (1993).

Table 14 Relationships Between Hypochlorous Acid (HOCl) Content and pH

pH	Amount of chlorine present as HOCl species (%)
4.5	100
5.0	98
7.0	94
7.0	75
8.0	23
9.0	4
10.0	0

Source: Cords and Dychdala (1993).

ever, the other forms possess some antimicrobial activities (Cords and Dychdala, 1993).

b. Advantages Chlorinated sanitizers have a long experience as effective sanitizers. They also have rapid antimicrobial activity against a very wide spectrum of microorganisms, are nonstaining, nonresidual, economical to use, and their activity is not affected by water hardness or lower temperature.

c. Disadvantages Chlorinated sanitizers have the potential for chlorine gas formation if contaminated with acids. In addition, they may be corrosive to metal, plastic, or elastomers and are not very stable at high temperatures. Chlorinated compounds, when reacted with humic acids present in water, may form potentially toxic by-products referred to as trihalomethanes or ADX (alkyl organic halides).

d. Iodophors

Properties: Iodophors are mixtures of iodine and agents that act as carriers and solubilizers for the iodine. Today, the term *iodophor* refers to two basic types of aqueous iodine preparations: (a) reaction of iodine with polyvinylpyrrolidone (PVP) and (b) reaction of iodine with surfactant molecules. The latter type, iodine combined with surfactants, is the important type of compound with respect to food industry use. Iodophors are primarily produced from polyethoxylated nonylphenol or polyol, which is a block copolymer of propylene and ethylene oxide. Various other surfactants, including anionics, cationics, amphoteric, and other nonionics, have also been used. The iodine is bound in micellar aggregates in the carrier and, upon dilution, micelles are dispersed and the linkage of the iodine is progressively reduced (Cords and Dychdala, 1993). The forms of iodine present in aqueous solutions as a function of pH and the relative bactericidal activity of the various chemical species of iodine are illustrated in Table 15.

Advantages: Iodophors are useful because they are (a) fast-acting antimicrobials and show good activity against yeast and mold, (b) effective against a wide spectrum of bacteria, (c) nonirritating, (d) more stable in the presence of organic material than chlorine, (e) nonresidual, (f) not as affected by water hardness or organic contaminants as chlorine, (g) self-indicating, and (h) low in toxicity.

Disadvantages: Iodophors may stain some surfaces or products. They are somewhat unstable and ineffective at alkaline pH and elevated temperatures. They also lose activity rapidly at temperatures below 10°C. Iodophors are more expensive than chlorine, and the lower pH versions can be corrosive to soft metals.

Table 15 Relationship Between pH and Bacterial Efficacy of Iodine

pH	Major ionic species present	Relative bactericidal activity ^a
Acid	I ₂	+++
Intermediate	I ₂	+++
	HIO	++
Alkaline	IO ⁻	+
	IO ⁻	+
	IO ₃ ⁻	-
	I ⁻	-
	I ₃ ⁻	-

^a +++, most active; ++, moderately active; +, slightly active; - inactive.

Source: Cords and Dychdala (1993).

e. Quaternary Ammonium Compounds

Properties: The term *quaternary ammonium compound* (QAC) defines a group of chemical substances that are produced by a nucleophilic substitution reaction between tertiary amines and a suitable quaternizing agent, such as an alkyl halide or benzyl chloride. The basic chemical structure can be depicted as follows:

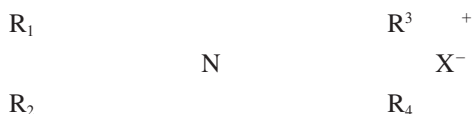

Where R₁, R₂, R₃, and R₄ represent covalently bound alkyl groups, which may be alike or different, substituted or unsubstituted, saturated or unsaturated, branched or unbranched, cyclic or acyclic, aromatic or substituted aromatic groups. In addition, the alkyl groups may contain ester, ether, or amide linkages. The nitrogen atom plus the attached R groups form the cation. The anion (X⁻), most often chloride, is bound to the nitrogen by ionic bonding (Cords and Dychdala, 1993).

The QACs were originally developed as aqueous solutions to be used as simple disinfectants. Today, many formulations are classified as detergent sanitizers in which quaternary compounds are combined with nonionic surfactants or other detergent builders.

Advantages: “Quats” are stable in concentrated and diluted forms, are relatively noncorrosive to metals, and are effective over a relatively wide pH range. In addition, they are more stable to heat and organic contamination, and provide some residual bactericidal activity as well as detergency.

Disadvantages: A few disadvantages of quats are (a) selectivity in antimicrobial action, not as effective against gram-negative bacteria, (b) not as effective at lower temperatures, (c) inhibited or inactivated by most anionics and hard water salts, (d) moderate to high foam limits application in CIP systems, (e) may leave an off-flavor in some products, (f) not effective against tuberculosis, and certain viruses and bacteriophage, and (g) residual activity may affect lactic acid bacteria in fermented products, and (h) overuse may adversely affect on-premise waste-treatment systems.

f. Acid-Anionic Surfactants

Properties: Anionic surfactants are characterized by a structural balance between a hydrophobic residue (e.g., paraffinic chain or alkyl-substituted benzene or naphthalene ring) and a negatively charged hydrophilic group (e.g., carboxyl, sulfate, sulfonate, or phosphate). The anionics employed in approved sanitizing solutions for use on food-contact surfaces include dodecylbenzene sulfonic acid, sodium dodecylbenzene sulfonate, sodium dioctylsulfosuccinate, sodium lauryl sulfate, sodium salt of sulfonated oleic acid, sodium 1-octane sulfonate, sulfonate 9-octadecenoic acid, sodium xylene sulfonate, dodecyldiphenyloxide disulfonic acid, sulfonated all oil fatty acid, and the sodium salt of naphthalene-sulfonic acid (Cords and Dychdala, 1993).

Advantages: The advantage of acid-anionics are (a) nonstaining, (b) devoid of objectionable odor, (c) effective in removing milkstone and waterstone, (d) effective against wide spectrum of organisms, (e) stable in concentrated and diluted forms, (f) stable in the presence of organic material and at high temperatures of application, and (g) noncorrosive to stainless steel. These products were developed to combine sanitizing and acid treatments in one step.

Disadvantages: Some disadvantages of acid-anionics are (a) effective in acid pH only, (b) excessive foam in CIP systems for some products, (c) slower activity against spore-forming organisms, (d) incompatible with quaternary ammonium compounds, and (e) active at lower temperatures.

g. Fatty Acid Sanitizers

Properties: Fatty acid sanitizers, also referred to as carboxylic acid sanitizers, are more recently developed compositions utilizing free fatty acids and sulfonated fatty acids combined with a mineral acid such as phosphoric acid. These compositions exhibit good overall bactericidal activities. Fatty acid sanitizers are effective at acid pH 2.5–3.5. They are noncorrosive to stainless steel equipment, are acceptable for CIP application, and are functional in removing hard water deposits during sanitizing.

Advantages: Fatty acid sanitizers are (a) effective broad-spectrum antimicrobials, (b) stable in the presence of organic material, (c) noncorrosive to stainless steel, (d) low foaming and suitable for CIP application, (e) both sanitizing with acidified rinse in one step, and (f) convenient to use.

Disadvantages: Some disadvantages are that they (a) are only effective at acid pH (pH of 4 or below), (b) are less effective against mold and spore-forming bacteria, (c) are not compatible with quats, (d) are less effective in cold temperatures, (e) are potentially corrosive to soft metals, (f) may be irritating to skin, and (g) possess a slight fatty acid odor.

h. Peroxyacetic Acid

Properties: Peroxyacetic acid (POAA) is a peroxygen compound that exhibits good antimicrobial activity. This compound, often referred to as the peroxide of acetic acid, is a strong oxidizing agent. Concentrated liquid POAA has a strong pungent odor, is soluble in water, usually contains stabilizers, and is adversely affected by high temperatures and metal ion contamination. Typical commercial formulations that contain POAA (ranging from 4 to 15%) also contain acetic acid, hydrogen peroxide, and a chelating agent. Most recently, new formulations containing other longer chain length carboxylic acids have been introduced (Cords, 1994). Some formulations may contain a small amount of sulfuric or phosphoric acid.

Advantages: Some advantages of peroxyacid compounds include rapid antimicrobial activity against a wide spectrum of organisms at lower temperatures (5°C) and at acid and neutral pH. They are noncorrosive to low-carbon grades of stainless steel. They are also (a) nonfoaming and suitable for CIP or spray applications, (b) nontoxic to humans at use concentrations, (c) biodegradable, (d) effective against biofilms, and (e) practically odorless at use solutions (Fatemi, 1999).

Disadvantages: A few disadvantages of peroxyacid compounds are that they (a) are not effective at alkaline pH, (b) have a pungent odor in concentrated product, (c) are difficult to be measured by conductivity at low use concentrations, and (d) have limited storage stability of use solution, (e) are destabilized by heavy metals, and (f) are corrosive to soft metals such as brass and copper and lower grades of stainless steel.

i. Hot Water Sterilization

Properties: Heat is the most widely used method for destruction of microorganisms. Hot water has been used successfully for sanitizing equipment and utensils for many years. Various forms of heat are utilized such as hot water, steam, or dry heat. Hot water and steam are more efficient than dry heat, because they cover all of the surfaces completely, including penetration into cracks and crevices much faster and more efficiently. According to the Grade "A" Pasteurized Milk Ordinance, hot water sanitation may be used as an alternative to chemi-

cal sanitation. This ordinance recommends complete immersion of utensils, vats, or equipment in hot water or hot water circulation maintaining the minimum temperature of 77°C for at least 5 min. Sometimes higher temperatures or longer times may be required to assure complete destruction of more heat-resistant organisms. The only requirement for effective heat sterilization is that all equipment and utensil surfaces must be completely clean. Hot water or steam sanitation has been largely replaced with chemical sanitizers because of high energy costs and time required for sanitizing.

Advantages: Hot water sanitation has several advantages over other forms of sanitizing in that it is (a) readily available, (b) nontoxic, (c) a good penetrant, (d) effective against a broad spectrum of organisms under conditions of time and temperature, and (5) nonresidual and nonfoaming.

Disadvantages: Hot water sterilization takes a longer time to sanitize when compared to the use of chemicals and is high in energy costs. It is also difficult to assure adequate temperature control and thus effectiveness in large systems. It also requires special equipment, may produce water hardness films, and can be unsafe as well as a difficult procedure to control. Expansion and contraction of equipment from external temperature fluctuation can also affect equipment integrity.

j. Ultraviolet Irradiation

Properties: Ultraviolet irradiation (UV) has been used for some time as a vehicle of supplemental disinfection in the food and dairy industry. Light rays of the UV lamp in the UV region of 2400–2800 Å produce antibacterial activity. Growth of organisms may be inhibited or they may be completely destroyed depending upon the efficiency of systems. Mold spores and viruses are most resistant and require as much as 50 or more times longer exposure in comparison to gram-negative organisms at the same dose (Shechmeister, 1991).

The UV rays are effective exclusively against microbes on surfaces, in air, and in clear liquids. They are absorbed by dust, thin films of fat, and turbid liquids. Hence, UV activity is limited to surface or thin-layer antimicrobial applications. Microbes that are presumably killed by ultraviolet irradiation can be revived by exposure to visible wavelengths of light. This phenomenon is called photoreactivation. The major use of UV lamps in the food and dairy industries is in the disinfection of air and water.

Advantages: The activity of UV irradiation is not dependent on pH or temperature but rather on time and location of the wavelength in the antimicrobial UV spectrum. In addition, it has a low overall toxicity and does not affect the taste or odor of foods. No residual or environmental effects are also advantages.

Disadvantages: Several disadvantages are (a) variable antimicrobial efficacy, (b) limited to surface and air sanitation, (c) distance from light determines

effectiveness, and (d) long exposure to UV irradiation may cause eye damage or skin irritation.

D. Factors Affecting Activity of Chemical Sanitizers

It is a well-recognized fact that activity of chemical germicides is affected by several different factors. The type of compound, concentration at which it is used, period of contact time, and temperature of the solution are of significant importance. There are, in addition, factors such as the presence of organic matter, pH of the solution, wetting ability, stability of the chemical, type or condition or number of organisms present, nature and condition of the surface to be treated, presence of incompatible compounds, residual film effect, and hard water conditions.

1. Concentration

In general, the higher the concentration, the faster the inactivation rate. Most often the concentration cannot be increased because of limitations by the FDA indirect food additive regulation where use levels are defined by each individual product label.

2. Time of Exposure

Time is a very important factor. The longer the contact time, the higher the inactivation rate. Sanitizers are approved by a protocol which requires a defined level of kill within 30 s at room temperature.

3. Temperature

As a general rule, the higher the temperature, the faster the kill of organisms. Most sanitizers are designed to be effective at room temperature. Iodophors are limited to below 50°C because of high vapor pressure. Also, they exhibit poor efficacy at low temperatures. Peroxyacid sanitizers and chlorinated compounds show good low-temperature efficacy and are effective at a temperature as low as 5°C. In general, QACs exhibit reduced activity at lower temperatures with significant effects below 10°C (Taylor, 1999).

4. Organic Matter

The presence of organic material slows bactericidal activity. This is true of chlorinated sanitizers and, to a lesser degree, iodophors and quats. Carboxylic acid sanitizers, acid-anionic sanitizers, and peroxyacid sanitizers are less affected by organic contamination. Under heavily soiled conditions, all sanitizers will be adversely affected.

5. pH

The pH is a very important factor in germicidal activity of chemical sanitizers. Chlorinated sanitizers, iodophors, acid-anionics, peroxy acids, and fatty acid sanitizers are all dependent on low pH for their activity. Quats, chlorine dioxide, and phenolics are not as dependent on changes in pH.

6. Hard Water

Hard water directly slows antimicrobial activity of quats and phenolics. Other sanitizers appear not to be affected by hardness as high as 500 ppm CaCO_3 . Some quats do incorporate chelating agents to overcome water hardness. The modern quats, in general, have higher tolerances to hard water.

7. Wetting Ability

Wetting of surfaces helps in penetration of sanitizing solution into cracks and crevices. Acid-anionics, iodophors, QACs, perhaps carboxylic acid sanitizers, and the newer peracid/organic acid mixtures contain surfactants.

8. Stability of Product

Some products lose activity during storage and in solution. Acid-anionic sanitizers, carboxylic acid sanitizers, and QACs are very stable products. Most others, although stable in concentrate, will lose long-term stability in diluted solutions.

9. Type of Organism

Different organisms have different resistances to chemicals. Spore-forming organisms, viruses, and molds are most resistant to chemicals, and to destroy them, we need either higher concentrations and/or longer time exposures. The general order of descending resistance is shown in Fig. 1. To inactivate the more resistant forms, higher concentrations of chemical, longer exposure time, increased temperature, or a combination of all three must be employed. Prions, nonenveloped viruses, and spores are largely unaffected by standard no-rinse sanitizing solutions, and other control measures must be employed if their presence in the dairy product in questions pose a health risk. Chlorinated sanitizers, iodophors, and peroxyacid sanitizers exhibit the best broad-spectrum antimicrobial activity.

10. Condition and Number of Organisms

In general, the older the cell, the more resistant it becomes. Organisms in the log phase of growth are more sensitive than those in the stationary phase. Moist

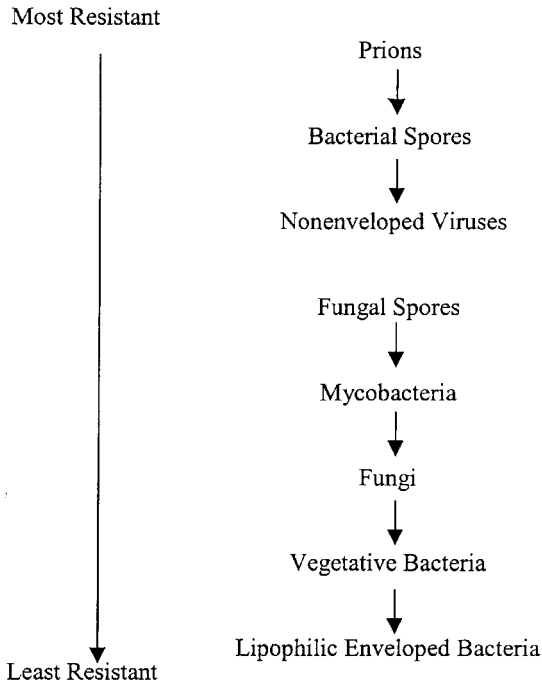

Figure 1 Resistance of infectious agents to biocidal agents.

bacteria are killed faster than bacteria in a the dry state. Also, the greater the number of organisms, the greater the chance for survivors.

11. Physical Condition of Surface

Microorganisms are more readily destroyed when on a smooth surface than on rough or porous surfaces with cracks and crevices.

12. Incompatible Compounds

It is important to be aware of chemical interactions that may severely inhibit activity of the sanitizer. Examples include (a) failure to rinse completely a detergent containing an anionic surfactant before applying a quaternary ammonium compound sanitizer, (b) following an acid rinse with a hypochlorite sanitizer with subsequent release of chlorine gas, and (c) use of peracetic acid–based sanitizers in water containing greater than 0.5 ppm iron.

13. Residual Activity

After sanitizing, some compounds leave a film on the surface, which exhibits residual antimicrobial activity for a short time. Acid-anionic sanitizers, carboxylic acid sanitizers, and quats belong to this group of sanitizers.

E. Application and Validation

1. Application

Sanitizer solutions can be utilized in several different ways. Usually, they may be applied from portable spray units, circulated through the equipment, or through soaking in vats or buckets. In CIP systems, sanitizing is the last step of the cleaning program. It usually employs a separate tank where the sanitizing solution is prepared at least once per day or more often if the solution is soiled or diluted. From the centralized sanitizer preparation system, the sanitizing solution may be piped to portable distribution points strategically located throughout the plant for easy use by operators. Generally, the portable units should contain the maximum concentration allowed by the no-rinse regulation to assure fast destruction of organisms. Should it be necessary to employ higher than approved concentrations, the surfaces must be rinsed with potable water followed by reapplication of an acceptable concentration of sanitizer.

Other possible ways that sanitizers can be applied: (a) through a fogger to sanitize air space in processing areas to control possible contamination from the air, (b) via foaming equipment to control surface contamination on walls, ceiling, floors, or outside of the equipment, (c) in foot baths to eliminate contamination by employee footwear before entering the processing areas, and (d) in hand soap stations to minimize contamination from hands.

After a sanitizer is applied, the operators and management routinely determine whether cleaning and sanitizing of any equipment was done correctly or not. To assess these results, a validation process is completed by visual, microbiological, organoleptic, and performance monitoring procedures.

2. Visual Validation

Based on everyday experience, operators are in a very good position to determine by visual inspection whether or not the equipment is clean. They check the rinse brake and sheathing of rinse water using a flashlight for tough soil areas or even a black light for scales. Operators can tell, and most of the time they are in agreement with, the more sophisticated methods.

3. Microbiological Validation

This is the more sophisticated method of evaluation where surface swabbing, rinsing, and RODAC plating is necessary. This procedure is good, but it takes 24–48 h for bacteria to grow and 3–7 days for yeasts and molds; thus, results are available long after the finished dairy product has left the plant. However, more recently, several procedures have been developed that provide more rapid identification of pathogens using enzymes and DNA, but these require special training and special equipment.

4. ATP Validation

This is the most recent innovation for immediate validation checking of cleaning and sanitizing procedures. This technology is based on determination of adenosine triphosphate (ATP), which is present in soil and in microorganisms. A mixture of luciferin/luciferase reagent, when added to released ATP from soil and microorganisms, will produce light that in turn is measured by a luminometer. Results on cleanliness and contamination can be obtained in several minutes, whereas the total plate count, by comparison, takes several days. A conclusion can be established between level of bacteria and ATP content; however, since food soils also contain ATP, it is more realistic to use ATP as an indicator of general cleanliness.

5. Performance Monitoring

This procedure involves actual checks during cleaning and sanitizing by use of a computer. It monitors during the CIP procedure and records temperature, pressure and flow, pH, conductivity, time, and concentration. Should there be any noticeable deviation from normal, it can be immediately corrected and save the procedure and time rather than waiting until the end of the cycle and having to repeat the procedure.

By using the aforementioned monitoring techniques, it is possible to make a decision about the cleaning and sanitizing results and, if necessary, make proper adjustments for bringing the sanitation process back under control.

VI. CONCLUSION

It is difficult to make direct comparisons between the various types of sanitizing solutions because of the variability in formulations among the commercially available products. The information provided in Tables 16 and 17 is based upon the most commonly used commercial products. Exceptions to the norm may be encountered, especially with respect to iodophor and quaternary ammonium com-

Table 16 Comparison of the Commonly Used Sanitizers^a in Chemical and Physical Properties

Property	Chlorine	Iodophors	Quaternary ammonium compounds	Carboxylic acids	Acid anionic surfactants	Peroxyacetic acid
Corrosive	Corrosive	Slightly corrosive	Noncorrosive	Slightly corrosive	Slightly corrosive	Slightly corrosive
Irritating to skin	Irritating	Not irritating	Not irritating	Slightly irritating	Slightly irritating	Not irritating
Effective at neutral pH	Yes	Depends on type	In most instances	No	No	Yes
Effective at acid pH	Yes, but unstable	Yes	In some instances	Yes, below 3.	Yes, below 3.0–3.5	Yes
Effective at alkaline pH	Yes, but less than at neutral pH	No	In most instances	No	No	Less effective
Affected by organic material	Yes	Moderately	Moderately	Moderately	Moderately	Partially
Affected by water hardness	No	Slightly	Yes	No	Slightly	Slightly
Residual antimicrobial activity	None	Moderate	Yes	Yes	Yes	None
Cost	Low	High	Moderate	Moderate	Moderate	Moderate
Incompatibilities	Acid solutions, phenols, amines	Highly alkaline detergents	Anionic wetting agents, soaps, and acids	Cationic surfactants	Cationic surfactants and alkaline detergents	Reducing agents metal ions, strong alkalines
Stability of use solution	Dissipates rapidly	Dissipates slowly	Stable	Stable	Stable	Dissipates slowly
Maximum level permitted by FDA without rinse	200 ppm	25 ppm	200 ppm	200 ppm sodium salt of oleic acid 350 ppm C8–C10 fatty acids	430 ppm dodecylbenzene sulfonate 200 ppm sodium salt of oleic acid	100–200 ppm
Water temperature sensitivity	None	High	High	Moderate	Moderate	None
Foam level	None	Low	Moderate	Low	Moderate	None
Phosphate	None	High	None	High	High	None
Soil load tolerance	None	Low	High	Moderate	Moderate	Low

^a Comparisons made at approved “no-rinse” use levels.

Source: Adapted from Cords and Dychdala (1993).

Table 17 Comparison of the Commonly Used Sanitizer^a in Antimicrobial Activity

Cidal activity against	Chlorine	Iodophors	Quaternary ammonium compounds	Carboxylic acids	Acid anionic surfactants	Peroxyacetic acid
Gram-positive non-spore-forming bacteria	++ ^b	++	++	++	++	++
Gram-negative bacteria	++	++	+	+	+	++
Bacterial spores	++	+	±	±	±	++
Yeast	+	++	+	±	+	+
Mold	++	++	+	+	+	++
Bacteriophage	++	+	±	±	±	++

^a Comparisons made at approved “no-rinse” use levels.

^b Relative effectiveness: ++, effective; +, moderately effective; ±, variable effectiveness: (a) depends upon specific formulation, (b) varies with genus or type, and (c) contact times required are in excess of practical use conditions.

Source: Adapted from Cords and Dychdala (1993).

pounds. The manufacturers of these products can provide the user with information relating to antimicrobial efficacy and other factors relevant to use of specific products.

REFERENCES

- Cords BR. New peroxyacid sanitizer. Proceedings of the 23rd Convention. Institute of Brewing. Sydney, Australia, 1994, pp 165–169.
- Cords BR, Dychdala GR. Sanitizers: halogens, surface-active agents, and peroxides. In: Davidson PM, Branen AL, eds. Antimicrobials in Foods. 2nd ed. New York: Marcel Dekker, 1993, pp 469–537.
- Elliot RP. Cleaning and Sanitizing. In: Katsuyama AH, ed. Principles of Food Processing Sanitation. Washington, DC: Food Processing Institute, 1980.
- FDA. Code of Federal Regulations, Title 21 CFR, Part 178, Section 1010 Washington, DC: US Government Printing Office, 1999.
- Fatemi P, Frank JF. Inactivation of *Listeria monocytogenes*/*Pseudomonas* biofilms by peracid sanitizers. J Food Prot 62:761–765, 1999.
- Shechmeister IL. In: Block SS, ed. Disinfection, Sterilization, and Preservation. 4th ed. Philadelphia, Lea & Febiger, 1991, pp 553–565.
- Taylor JH, Rogers SJ, Holah JT. A comparison of the bactericidal efficacy of 18 disinfectants used in the food industry against *Escherichia coli* 0157:H7 and *Pseudomonas aeruginosa* at 10° and 20°C., J. Appl Microbiol 87:178–725, 1999.

Key References for Detergents and Antimicrobials

- Block SS. Disinfection, Sterilization and Preservation. 4th ed. Philadelphia: Lea & Febiger, 1991.
- Cutler WG, Kissa E. Detergency Theory and Technology. New York: Marcel Dekker, New York, 1987.
- Davidson PM, Branen AL. Antimicrobials in Foods. 2nd ed. New York: Marcel Dekker, 1993.
- Russell AD, Hugo WB, Ayliffe CAJ. Disinfection, Preservation and Sterilization. 3rd ed. Oxford, UK: Blackwell, 1999.

15

Control of Microorganisms in Dairy Processing: Dairy Product Safety Systems

Robert D. Byrne

*National Milk Producers Federation
Arlington, Virginia*

J. Russell Bishop

*University of Wisconsin–Madison
Madison, Wisconsin*

I. INTRODUCTION

Control of microorganisms in dairy processing is necessary to produce a safe product of the highest quality. The focus of this chapter is on production of safe dairy products. To accomplish this, pathogenic microorganisms need to be controlled. Whereas the techniques described result in a high-quality product, the intent of a dairy product safety system is to ensure that a safe product reaches the consumer. One of the most effective ways to control microorganisms is through the use of the Hazard Analysis and Critical Control Point (HACCP) program (Anonymous, 1996a; Pierson and Corlett, 1992). However, a complete dairy processing system encompasses more than just HACCP. To ensure that all hazards are addressed and a safe product is produced, prerequisite programs must be in place before HACCP controls are addressed. A sound prerequisite program also simplifies the HACCP program and minimizes the number of critical control points that need to be monitored. This chapter focuses on those areas that are defined as prerequisites and how effectively to control them, describes the implementation of a HACCP program, and provides a model HACCP program as a guide to developing an effective safety system in a dairy plant.

II. PREREQUISITES/GOOD MANUFACTURING PRACTICES

Before developing HACCP plans under the Dairy Products Safety System (Anonymous, 1996b), it is necessary for dairy plants to have developed, documented, and implemented programs to control factors that may not be directly related to manufacturing controls but support HACCP plans. These are prerequisite programs and need to be effectively monitored and controlled before HACCP plans are developed. Prerequisite programs are defined as universal steps or procedures that control operational conditions within a dairy plant, allowing for environmental conditions that are favorable to production of safe dairy products. Prerequisite areas include premises, receiving and storage, equipment performance and maintenance, personnel training, sanitation, and recalls (Anonymous, 1995, 1996a).

When implementing HACCP in a dairy plant, the first step is to review existing programs to verify whether all prerequisite requirements are being met and whether all necessary controls and documentation (e.g., program description, individual responsible, and monitoring records) are in place. Prerequisite programs are evaluated for their conformance to minimum requirements. Effectiveness of programs is monitored and required records are properly maintained.

The importance of prerequisite programs cannot be overstated. Prerequisite programs are the foundation of HACCP plans and must be adequate and effective. If any portion of a prerequisite program is not adequately controlled, then additional critical control points would have to be identified, monitored, and maintained under HACCP plans. In summary, comprehensive, effective prerequisite programs simplify HACCP plans and ensure that the integrity of the HACCP plan is maintained and that the manufactured product is safe.

A. Premises

Buildings and surroundings must be designed, constructed, and maintained to prevent conditions that may result in contamination of dairy products. Dairy plants must have an adequate program in place to monitor and control all elements in this section and maintain appropriate records. Premises include all elements of the building and building surroundings: outside property, roadways, drainage, building design and construction, product flow, sanitary facilities, and water quality. Adherence to requirements is verified through the written program of the plant, which outlines procedures that ensure satisfactory conditions are maintained (e.g., areas to be inspected, tasks to be performed, persons responsible, inspection frequencies, and records to be kept).

Land must be free of debris and refuse and must not be in close proximity to any source of pollution (e.g., objectionable odors, smoke, dust, or other contaminants). Roadways must be properly graded, compacted, dust proof, and

drained. Premises and shipping and receiving areas must provide or permit good drainage.

The building and facilities must be designed to readily permit cleaning, prevent entrance and harboring of pests, and prevent entry of environmental contaminants. Buildings need to be of sound construction, maintained in good repair, and not present any microbiological, chemical, or physical hazards to the dairy food. The building must be designed to provide suitable environmental conditions, permit adequate cleaning and sanitation, minimize contamination by extraneous materials, prevent access by pests, and provide adequate space for satisfactory performance of all operations. Construction and layout should reflect approved blueprints where applicable.

Floors, walls, and ceiling materials, as well as various coating and joint sealants, must be approved materials that are durable, smooth, cleanable, and suitable for production conditions conducted in the area. Walls must be light colored and well joined. Floors must be sufficiently sloped for liquids to drain into trapped outlets. Windows, if opened, must be equipped with close fitting screens. Doors must have smooth, nonabsorbent surfaces that are close fitting. Stairs, elevators, and other structures must be situated and constructed so that there is no contamination of dairy food and packaging materials. Overhead structures must be designed and installed in a manner that prevents contamination of dairy food and packaging materials and does not hamper cleaning operations.

Adequate lighting must be provided throughout the establishment. For operational purposes, lighting should not alter food colors. Light bulbs and fixtures suspended over exposed dairy food or packaging materials at any stage of production or storage must be of a safety type or be protected to prevent contamination of food if breakage occurs. Ventilation must be provided to prevent a build-up of heat, steam, condensation, or dust and to remove contaminated air. In microbiologically sensitive areas, positive air pressure needs to be maintained. Ventilation openings must be equipped with close-fitting screens or otherwise protected with noncorrodible material. Air intakes must be located to prevent an intake of contaminated air.

Drainage and sewage systems must be equipped with appropriate traps and vents. Plants must be designed and constructed so that there is no cross connection between the effluent of human wastes and any other wastes in the plant. Facilities must be provided for storage of waste and inedible material before removal from the plant. These facilities must be designed to prevent contamination. Containers used for waste must be clearly identified and leak proof.

The traffic pattern of employees and equipment must avoid cross contamination of the product. Product flow must prevent contamination of the dairy food through physical or operational separation. Plants must provide physical and operational separation of incompatible operations. The facilities must be adequate

for maximum production volume that is encountered. Living quarters and areas where animals are kept must be completely separated from and not open directly into areas where dairy foods or packaging materials are handled or stored.

Washrooms with self-closing doors must be provided. Washrooms, lunchrooms, and change rooms must be separate from and not lead directly into food processing areas and must also be correctly ventilated and maintained. Washrooms must have hand-washing facilities with a sufficient number of well-maintained sinks with properly trapped waste pipes connected to drains. Hand-washing facilities must have hot and cold potable running water, soap, sanitary hand-drying supplies or devices, and, where required, a cleanable waste receptacle.

Processing areas must contain a sufficient number of conveniently located hand-washing stations with properly trapped waste pipes connected to drains. In processing areas, remote controlled (e.g., foot, knee, timed) hand-washing stations are preferable. Sanitizing facilities (e.g., hand dips) must be in areas where plant employees are in direct contact with microbiologically sensitive dairy foods. Notices must be posted for employees to wash hands.

Plants must provide adequate facilities and means for cleaning and sanitizing equipment. Separate means must be provided for cleaning and sanitizing equipment used for inedible materials.

The water control program evaluates the microbiological, chemical, and physical quality of source and in-plant water (from various points of usage). This water includes the steam supply, cooling medium, process waters, and ice supply. The program establishes frequency of testing, procedures for testing, person responsible, and records to be kept. The plan has procedures in place to deal with water that does not meet specific standards. Records of water potability (laboratory test results) and water treatments applied must be maintained.

Potable hot and cold water is used in dairy food processing, handling, packaging, and storage areas and must be provided at adequate temperatures and pressures and in quantities sufficient for all operational and cleanup needs. Where required, facilities that protect against contamination must be provided for storage and distribution of water. Bacteriological testing of water is done on a semiannual basis for municipal water and on a monthly basis for water from other sources. Records of water potability testing must be maintained.

When chlorination of water occurs on premises, a metering device for adding the correct concentration of chlorine, which is designed to readily indicate a malfunction, must be used. Also, twice daily checks to determine total available chlorine must be done or an automatic analyzer equipped with a recorder, and an alarm must be used.

No cross connections can exist between potable and nonpotable water supply systems. Nonpotable water is never used in dairy food processing, handling,

packaging, or storage areas. All hoses, taps, cross connections, or similar sources of possible contamination must be equipped with antibackflow devices.

Water treatment chemicals used must be appropriate for their intended purpose. The treatment process and recirculated water and process waters must be treated and maintained in a condition so that no health hazard results from their use. Recirculated water must be a separate distribution system that can be readily identified. Records of treatment must be maintained. Microbiological testing needs to be done to monitor effectiveness.

Ice must be made from potable water and manufactured, handled, and stored to protect it from contamination. Bacteriological testing of ice must be done on a semiannual basis for plants using municipal water supplies and on a monthly basis for plants using other sources. Records of ice potability testing must be maintained.

Steam coming into direct contact with dairy food or food contact surfaces must be generated from potable water with no harmful substances added. The steam supply must be adequate to meet operational requirements. Boiler treatment chemicals used must be appropriate for their intended use. Records of treatments must be maintained.

B. Receiving and Storage

Plants must receive, inspect, and store ingredients, packaging material, and incoming materials in ways to prevent conditions that may result in contamination of dairy foods. Plants must have an adequate program in place to monitor and control all elements in this section and maintain the appropriate records.

Raw materials, ingredients, and packaging material (i.e., incoming materials) must be inspected on receipt and stored and handled in a sanitary manner (i.e., to prevent microbiological, chemical, or physical contamination). Effective measures must be taken to prevent contamination of raw materials, ingredients, and packaging materials by direct or indirect contact with contaminating material. Certification of some incoming materials by letters of guarantee, certificates of analysis, or other satisfactory means may be required and then should be in accordance with the HACCP plan.

Incoming materials must be received into an area separate from the processing area. All food additives must be food grade (i.e., they meet Code of Federal Regulations [CFR] [Anonymous, 1996] specifications or equivalent). All ingredients must be safe and not impact negatively on safety of the dairy food. Plants must use packaging materials that are appropriate for their intended use. Incoming raw materials, ingredients, and packaging materials must be monitored on receipt for acceptability for use in dairy foods, and records of this monitoring need to be maintained.

Where applicable, plants must have adequate means of establishing, maintaining, and monitoring temperature and humidity of rooms where raw materials, ingredients, packaging materials, and dairy foods are stored. Records of monitoring must be maintained.

Raw materials, ingredients, and packaging materials must be handled and stored in ways to prevent damage and contamination, and must be held to avoid growth of microorganisms. Conditions of storage and transport must be such that safety of the dairy food is not affected.

Returned or damaged goods must be clearly identified and stored in a designated area for appropriate disposition. Conditions of storage must not affect the safety of the finished product. Detergents, sanitizers, or other chemical agents in a dairy plant must be properly labeled, stored, and used in ways that prevent contamination of dairy foods, packaging materials, and food contact surfaces. Chemicals must be stored and handled in an area that is kept dry and well ventilated and is separate from all food handling areas. Chemicals must be mixed and stored in clean, labeled containers and dispensed and handled only by authorized and properly trained personnel.

C. Equipment Performance and Maintenance

Dairy plants must use equipment that is designed for production of dairy foods and must install and maintain equipment in ways to prevent conditions that may result in contamination of food. Plants must have an adequate program in place to monitor and control all elements in this section and maintain appropriate records.

Equipment and utensils must be designed and maintained in ways that prevent contamination of dairy foods and be constructed of corrosion-resistant material. Food contact surfaces must be nonabsorbent, nontoxic, smooth, free from pitting, unaffected by food, and able to withstand repeated cleaning and sanitizing. All chemicals, lubricants, coatings, and paints used on equipment in contact with food must be appropriate for their intended use.

Equipment and utensils must be installed in a way that prevents contamination of food with adequate space within and around equipment. Equipment must be accessible for cleaning, sanitizing, maintenance, and inspection. Where required, equipment must be properly vented. Equipment must be maintained in a clean and sanitary manner in accordance with the sanitation program. Equipment and utensils used to handle inedible material must not be used to handle edible material. Containers for inedible and waste material must be clearly identified and be leak proof.

Monitoring devices and any equipment that could have an impact on dairy food safety must be listed together with their intended use. Protocols and

calibration methods must be established for those equipment and monitoring devices. This may include thermometers, pH meters, a_w meters, refrigeration unit controls, scales, recording thermometers, recording hygrometers, and other equipment.

Frequency of calibration, responsible person, monitoring and verification procedures, appropriate corrective actions, and record keeping must be specified. If reagents are used for monitoring or verification activities, procedures for keeping and calibrating reagents must be documented. Required information on calibration of reagents includes frequency of testing for all reagents, responsible person, dating system, storage conditions, and records to be kept.

A preventive maintenance program must be in place that lists equipment and utensils together with preventive maintenance procedures. The program specifies necessary servicing of equipment and frequency, including replacement of parts, responsible person, method of monitoring, verification activities, and records to be kept.

D. Personnel Training

Dairy plants must have an adequate program in place to monitor and control training programs and maintain appropriate documentation. The objective of the personnel training program must be to ensure safe food handling practices. The personnel training program must provide, on an ongoing basis, necessary training for production personnel. A procedure must be developed to verify effectiveness of the training program.

Production personnel must be trained to understand critical elements for which they are responsible, what critical limits are, importance of monitoring limits, and actions they must take if limits are not met. Ongoing training in personal hygiene and hygienic handling of food must be provided to every food handler, and training in personal hygiene and hygienic handling of food must be provided to all persons entering food handling areas. Plants must demonstrate that personal hygiene is carried out and controlled. No person known to be suffering from or to be a carrier of a disease likely to be transmitted through food or afflicted with infected wounds, skin infections, sores, or diarrhea is permitted to work in any food handling area in any capacity in which there is any likelihood of such a person contaminating food with pathogenic microorganisms. All persons having open cuts or wounds may not handle food or food contact surfaces unless the injury is completely protected by a secure, waterproof covering.

All persons entering a dairy food production area must wash their hands thoroughly with soap under warm-running potable water. Hands must be washed after handling contaminated materials and after using toilet facilities. Where required, employees must use disinfectant hand dips.

All persons working in dairy food handling areas must maintain personal cleanliness while on duty. Protective clothing, hair covering, and footwear functional to the operation in which the employee is engaged must be worn and maintained in a sanitary manner. Gloves, if worn, must be clean and sanitary. All persons entering dairy food handling areas must remove objects from their person that may fall into or otherwise contaminate food. Tobacco, gum, and food are not permitted in dairy food handling areas. Jewelry must be removed before entering food handling areas. Jewelry, including Medic Alerts that cannot be removed, must be covered. Personal effects and street clothing must not be kept in food handling areas and must be stored in a manner to prevent contamination of dairy foods.

Access of personnel and visitors must be controlled to prevent contamination. All necessary precautions must be taken to prevent contamination, including use of foot baths and hand dips where required.

E. Sanitation

Plants must have an adequate sanitation program in place and maintain appropriate records. The sanitation program outlines parameters that need to be controlled to ensure safety of the dairy food product. Sanitation procedures must be developed for equipment, utensils, overhead structures, floors, walls, ceilings, drains, lighting devices, refrigeration units, and anything else impacting on safety of the dairy food. Equipment and facilities must be cleaned and sanitized as defined in a written schedule. Cleaned equipment must be visually inspected on a routine basis. Equipment must be free of any residue and foreign material before being used.

For each area and each piece of equipment and utensil, the written cleaning and sanitizing program specifies name of person responsible, chemicals used, procedures used, and frequency of cleaning and sanitizing.

Chemicals must be used in accordance with the manufacturer's recommendations. The sanitation program must be carried out in a way so it does not contaminate food packaging materials during or after cleaning and sanitizing. Equipment for cleaning and sanitizing food processing equipment must be designed for its intended use and properly maintained.

Hand-cleaned or cleaned out-of-place (COP) equipment must be disassembled for each cleaning and inspection, whereas equipment cleaned by an accepted clean in-place (CIP) system must be inspected as prescribed in the CIP program. General housekeeping and special sanitation procedures carried out during operations must be specified (e.g., mid-shift cleanup, responsible person, procedure).

Examples of information to be included in the written sanitation program are (a) area/line, equipment to be cleaned, frequency, and responsible person;

(b) special instructions for cleaning specific equipment and responsible person; (c) cleaning equipment that is to be used along with instructions for its proper operation (e.g., pressure, volume); (d) detergent/sanitizer to be used (including commercial and generic names, dilution factor, temperature); (e) method to apply the solution, contact time, foam consistency, scrubbing (if necessary), high/low pressure; (f) rinsing instructions, water temperature; (g) sanitizing instructions, commercial and generic names, dilution factor, pH, temperature, contact time; (h) final rinsing instructions (if applicable); and (i) safety instructions for products.

Adherence to the written sanitation program must be monitored and recorded (e.g., temperature, concentration, contact parameters). Effectiveness of the sanitation program must be monitored on a routine basis by a company representative (e.g., using microbiological swab tests, visual inspection of areas/equipment, or direct observation of sanitation procedures done by designated personnel). Operations should begin only after all sanitation requirements are met. Records of all monitoring results need to be maintained. Deviations and corrective actions taken must be recorded.

Dairy plants must have an adequate, effective, safe, and written pest control program in place and must maintain appropriate records. Birds and animals must be excluded from dairy plants. The written pest control program should include name of a contact person at the establishment for pest control, name of any applicable extermination company or name of person responsible for the program, list of chemicals and methods used, a map of bait and trap locations, frequency of treatment and inspection, and pest survey and control reports. Chemicals must be used according to manufacturer's instructions, appropriate for their intended use, and used in a manner to prevent contamination.

Adherence to the written pest control program must be monitored and recorded. Effectiveness of the pest control program must be verified by on-site inspection of areas for the presence of insect and rodent activity. Records of all monitoring results, recommendations, and action taken must be maintained.

F. Recalls

The recall program outlines procedures that the company would implement in the event of a product recall. The objective of the written recall procedure is to ensure that an identified dairy food is removed from the market as efficiently, rapidly, and completely as possible via a plan that can be put into operation at any time. The program must be tested to validate its effectiveness.

Each manufacturer of a dairy food product must maintain a system of control that permits a complete and rapid recall of any lot of food product. The written recall procedure includes the following:

1. Documentation pertaining to the product coding system. All products must be identified with a production date or code identifying each lot. Sufficient coding of dairy products is used and explained in the written recall program to permit positive identification and to facilitate an effective recall.
2. Finished product distribution records must be maintained for a time that exceeds the shelf life of the product. Records must be adequately designed and maintained to facilitate location of the product if it is recalled.
3. A complaint file must be maintained. Records documenting all related complaints and action taken must be included.
4. Responsible individuals who are part of the recall team, along with their respective business and home telephone numbers, must be listed. For each individual, an alternate is designated to act on his or her behalf in the event of absence. Roles and responsibilities for every member on the recall team must be clearly defined.
5. The step-by-step procedures to follow for a recall must be described. These procedures should include extent and depth of the recall (i.e., consumer, retailer, or wholesaler level) according to the recall classification.
6. Means of notifying affected customers in a manner appropriate to the type of hazard must be defined. Channels of communication (FAX, telephone, radio, letter, or other means) to be used for trace-back and recovery of all affected products must be identified. Typical messages directed to consumers, retailers, or wholesalers according to severity of hazards must be included.
7. Control measures for the returned recalled dairy food must be planned. This includes both returned product and product still in stock on the premises. Control measures and disposal of the affected product must be described according to the type of hazard involved.
8. Means of assessing progress and efficacy of the recall must be stated. A method of checking effectiveness of the recall needs to be defined.

Any manufacturer who initiates a food safety–related recall of a food immediately notifies the regulatory agency that has jurisdiction with information that includes (a) reason for the recall; (b) recalled product identification (e.g., name, code marks or lot numbers, plant number, date of production, date of importation or exportation, if applicable); (c) amount of recalled product involved, subdivided to include original quantity of product, distributed quantity, and quantity remaining in possession of the company; (d) areas of distribution of the recalled food, by areas, cities, states, and, if exported, by country, along with names

and addresses of retailers and wholesalers; and (e) information on any other product that could be affected by the same hazard.

III. HAZARD ANALYSIS AND CRITICAL CONTROL POINT—AN OVERVIEW

After prerequisite programs have been completed and documented, an HACCP program can be implemented. Use of the HACCP system is not new to the dairy food industry. HACCP is a logical, simple, effective, but highly structured system of food safety control. It is a system designed to identify ‘‘hazards and/or critical situations’’ and to produce a plan to control these situations.

The HACCP system was introduced to the food industry as a ‘‘spinoff’’ of the space program during the 1960s. The National Aeronautics and Space Administration (NASA) used HACCP to provide assurance of the highest quality available for components of space vehicles. This program, which was designed to develop assurance of product reliability, was carried over into development of foods for astronauts.

The U.S. Army Natick Laboratories, in conjunction with NASA, began to develop foods needed for manned space exploration. They contracted with the Pillsbury Company to design and produce the first foods used in space. While researchers at Pillsbury struggled with certain problems, such as how to keep food from crumbling in zero gravity, they also undertook the task to come as close as possible to 100% assurance that foods they produced would be free of bacterial or viral pathogens. A foodborne illness that causes severe diarrhea in the confines of a space suit combined with zero gravity could be just as catastrophic to astronauts as a failure of the rockets.

Use of standard quality control methods common to the food industry was soon proven to be unworkable for the task Pillsbury had undertaken. Either the degree of safety desired was not provided or product sampling would have been prohibitive to commercialization of space foods. Pillsbury researchers discarded the standard quality control methods and began an extensive evaluation, in conjunction with NASA and Natick Laboratories, to evaluate food safety. They soon realized that to be successful they would need control over their process, raw materials, environment, and their people. In 1971, they introduced HACCP as a preventive system that provided manufacturers a high degree of assurance that foods were produced safely. If the HACCP system is correctly implemented, there is little requirement for testing of final product other than for verification purposes.

HACCP is a management tool that provides a more structured approach to control of identified hazards than that achievable by traditional inspection and

quality control procedures. It starts with product design and provides a means to identify potential areas of concern, where failure has not yet been experienced, and is, therefore, particularly useful for new operations. HACCP is a logical basis for better decision making with respect to product safety. It provides dairy food manufacturers with greater security of control over product safety than is possible with endproduct testing. HACCP has international recognition as the most effective means of controlling foodborne disease and is endorsed as such by the joint Food and Agriculture Organization/World Health Organization (FAO/WHO) Codex Alimentarius Commission.

One of the key advantages of the HACCP concept is that it enables a dairy food manufacturing company to move away from a philosophy of control-based testing (i.e., testing for failure) to a preventive approach, whereby potential hazards are identified and controlled in the manufacturing environment (i.e., prevention of product failure).

HACCP has many other benefits as well: It ensures dairy product safety, is science based, focuses appropriate technical resources on critical processes, lessens emphasis on endproduct testing, focuses on prevention, uses resources effectively, and meets customer expectations.

HACCP has been recognized internationally as a logical tool for use in moving toward a more modern, scientifically based inspection system. The most important element of a HACCP-based system is its preventive nature, and it thus exercises control throughout the manufacturing process at critical steps. By doing so, defects that could impact on the safety of the dairy food being processed can be readily detected and corrected at these points before the product is completely processed and packaged.

IV. PRINCIPLES OF HAZARD ANALYSIS AND CRITICAL CONTROL POINT

The following seven principles of HACCP were adopted by the National Advisory Committee on Microbiological Criteria for Foods (Pierson and Corlett, 1992). These principles allow for a systematic approach to dairy product safety:

1. Conduct a hazard analysis associated with growing, harvesting, raw materials and ingredients, processing, manufacture, distribution, marketing, preparation, and consumption of the dairy food.
2. Identify critical control points (CCPs) required to control identified hazards in the process.
3. Establish critical limits for preventive measures associated with each identified CCP.

4. Establish CCP monitoring requirements. Establish procedures for using results of monitoring to adjust the process and maintain control.
5. Establish corrective actions to be taken when monitoring indicates there is a deviation from an established critical limit.
6. Establish effective record-keeping systems that document the HACCP plan.
7. Establish procedures for verification that the HACCP system is working correctly.

V. HAZARD COMPONENTS

To produce a safe dairy product effectively, all hazards that might occur must be controlled, reduced to an acceptable level, or eliminated. An effective prerequisite program should control many of the environmental hazards. The HACCP system controls any remaining hazards inherent to the food or that may result from processing.

The three hazards that must be controlled are microbiological, chemical, and physical hazards (Anonymous, 1996b; Pierson and Corlett, 1992). There are three types of microbiological hazards: severe, moderate with potentially extensive spread, and moderate with limited spread.

Severe microbiological hazards include *Brucella*, *Clostridium botulinum*, *Listeria monocytogenes*, *Salmonella* Typhi, *S. Paratyphi*, *S. Dublin*, *Shigella dysenteriae*, and hepatitis A and E. Microbiological hazards with potentially extensive spread include *Salmonella* spp., enterotoxigenic *Escherichia coli*, enteroinvasive *E. coli*, *E. coli* O157:H7, *Shigella* spp., viruses, and *Cryptosporidium*. Microbiological hazards that are moderate with limited spread include *Bacillus cereus*, *Campylobacter jejuni* and other species, *Clostridium perfringens*, *Staphylococcus aureus*, *Aeromonas* spp., *Yersinia enterocolitica*, and parasites.

Physical hazards that could potentially occur include entry into the food of metal, glass, insect/pest parts, dirt, wood fragments, personal effects, plastic, and any other physical object that may render the food unsafe. Chemical hazards that may occur include the presence of natural toxins, metals, drug residues, sanitizer residues, pesticides, food additives, and inadvertent chemicals. Natural toxins include mycotoxins and other natural thyrotoxicoses. Mycotoxins are divided into those causing acute and chronic mycotoxicoses. The acute mycotoxins include ochratoxin, trichothecene, zearalenone, and aflatoxin, whereas the chronic mycotoxins include aflatoxin, sterigmatocystin, and patulin. Metal hazards include the presence of copper, cadmium, and mercury. Drug residues are beta-lactams, sulfonamides, tetracyclines, and others. Examples of sanitizer residues

are chlorinated compounds, fatty acids, and idophors. Inadvertent chemicals include among others lubricants and boiler additives.

VI. HAZARD ANALYSIS AND CRITICAL CONTROL POINT IMPLEMENTATION

Implementation of HACCP involves a 12-step process, which, when complete and maintained, ensures a safe dairy product is being produced.

A. Step 1: Gain Management Commitment and Assemble the HACCP Team

Before proceeding to the HACCP team selection, it is extremely important to get full commitment from all levels of management to the HACCP initiative. Without a firm commitment of time, personnel, and resources, the HACCP plan may be difficult, if not impossible, to implement effectively. The first step in developing an HACCP plan is to assemble an HACCP team consisting of individuals who have specific knowledge and expertise appropriate to the dairy product and process. It is the team's responsibility to develop each step of the HACCP plan. The team should be multidisciplinary and should include all personnel who are directly involved in the daily process activities, because they are most familiar with the operation.

It is recommended that experts who are knowledgeable about the dairy food and its process should either participate in or verify the completeness of the hazard analysis and the HACCP plan. These individuals should have the knowledge and experience needed to identify correctly potential hazards; assign levels of severity and risk; recommend controls, criteria, and procedures for monitoring and verification; recommend appropriate corrective actions when a deviation occurs; and recommend research related to the HACCP plan if important information is not known.

B. Step 2: Describe Dairy Food and Method of Distribution

A separate HACCP plan must be developed for each dairy food product that is being processed in a facility. The HACCP team must first fully describe the dairy food product or intermediate dairy product if only part of the process is studied. The dairy product should be defined in terms of composition, structure, processing, packaging system, storage, required shelf life, and instructions for use.

The method of distribution should be described along with information on whether the dairy food is to be distributed frozen or refrigerated or is shelf stable.

Consideration should be given to the potential for abuse in the distribution channel and by consumers, but the question, “Is this a hazard or a quality issue?” must be asked.

C. Step 3: Identify Intended Use and Potential Consumers

The intended use of the dairy food should be based on its normal use by end-users, consumers, and consumer target groups. Intended consumers or users may be the general public, a particular segment of the population, another food (dairy or nondairy), or nonfood product. The use of dairy foods as an intermediate or nontraditional product represents a growing market and must be considered more so than in the past.

Intermediate or nontraditional products include dairy foods that serve as ingredients (e.g., cheeses used in processed foods, whey products used in infant formulas, canned cheese, modified atmosphere-packaged dairy foods). Particular attention should be given to lower fat dairy products, because reduction of fat within the product alters its composition as related to water activity, pH, and other characteristics important to microbiological safety of the product.

D. Step 4: Develop and Verify a Flow Diagram

The purpose of the flow diagram is to provide a clear, simple description of steps involved in production of the dairy food. The scope of the diagram must cover all steps in the process that are directly under control of the facility. The flow diagram should consist of words in boxes, not engineering drawings. When developing a flow diagram, certain types of information must be considered: prerequisites/good manufacturing practices already established, all raw materials/ingredients and packaging used (microbiological, chemical, and physical data), sequence of all process steps (including raw material addition), time/temperature considerations, product recycle/rework loops, and storage and distribution conditions.

The HACCP team should inspect the operation to verify accuracy and completeness of the flow diagram by taking the diagram to the production floor and walking through the steps to ensure accuracy of the diagram. The flow diagram should be modified as necessary.

E. Step 5: Conduct a Hazard Analysis (Principle 1)

A hazard is any microbiological, chemical, or physical property that may cause a dairy food to be unsafe for human consumption. The HACCP team conducts a hazard analysis and identifies steps in the process where hazards of poten-

tial significance can occur. Hazards must be of such a nature that their prevention, elimination, or reduction to acceptable levels is essential to production of a safe dairy food. The team must consider what preventive measures, if any, can be applied for each hazard.

Hazard analysis and identification of associated preventive measures allow identification of those hazards of significance and associated preventive measures, modification of a process or product to further assure or improve safety, and determination of CCPs in principle 2.

During hazard analysis, the potential significance of each hazard should be assessed by considering its risk and severity. The estimate of risk is usually based on a combination of experience, epidemiological data, and information in the technical literature. Safety concerns must be differentiated from quality concerns. The term *hazard* is limited to safety.

Upon completion of the hazard analysis, significant hazards associated with each step in the flow diagram should be listed along with any preventive measures to control the hazards. For example, if the HACCP team were to conduct a hazard analysis for the manufacture of yogurt, possible pathogens in raw milk would be identified as a potential hazard. Thus, pasteurization would be listed along with the hazard as the preventive measure. Hazards should be only those that will result in an unsafe product. This same approach may be used for quality or economic issues, but HACCP is limited to product safety only.

F. Step 6: Critical Control Points (Principle 2)

A CCP is any point, step, or procedure at which control can be applied and a dairy food safety hazard can be prevented, eliminated, or reduced to an acceptable level. The hazard analysis conducted in step 5 has identified areas that are necessary to control. The prerequisite/good manufacturing practices program may be used to control many of the identified hazards. Any hazards not controlled through prerequisite programs must be identified as CCPs.

Examples of CCPs include temperature of incoming raw milk, animal drug residue monitoring in raw milk, storage temperature of raw milk or cream, pasteurization temperature and time, and use of metal detectors.

Information developed during the hazard analysis should enable the HACCP team to identify which steps in the process are CCPs. Identification of each CCP can be facilitated by use of the CCP decision tree. All hazards that could reasonably be expected should be considered. Application of the CCP decision tree can help determine whether a particular step is a CCP for previously identified hazard.

Different facilities preparing the same dairy product can differ in the risk of hazards and the points, steps, or procedures that are CCPs. This can result

from differences in each facility layout, equipment, selection of ingredients (including raw versus pasteurized milk), or the process that is used. This is why HACCP plans must be developed by each individual plant for every product it produces.

G. Step 7: Critical Limits (Principle 3)

A critical limit is a criterion that must be met for each preventive measure associated with a CCP. Therefore, there is a direct relationship between the CCP and its critical limits that serve as boundaries of safety. Critical limits must be met to ensure safety of the dairy product. Exceeding a critical limit means a health hazard may exist or develop or the product was not produced under conditions assuring safety. Critical limits may be derived from sources such as regulatory standards and guidelines, literature searches, experimental studies, and experts. Critical limits may be established for preventive measures such as temperature, time, a_w , pH, titratable acidity, drug residues, and microbiological numbers and kinds.

H. Step 8: Monitoring/Inspection (Principle 4)

Monitoring is a planned sequence of observations or measurements to assess whether a CCP is under control and to produce an accurate record for future use in verification. Monitoring serves to track the system operation, determine when there is a loss of control and a deviation occurs at a CCP (i.e., exceeding the critical limit), and provide written documentation for use in verification of the HACCP plan.

Because of the potentially serious consequences of a critical defect, monitoring procedures must be effective. Ideally, monitoring should be at the 100% level. Continuous monitoring is possible with many types of physical and chemical methods (e.g., the time and temperature of pasteurization). The person responsible for monitoring also must report a dairy process or product that does not meet critical limits so that immediate corrective action can be taken.

When it is not possible to monitor a critical limit on a continuous basis, it is necessary to establish the monitoring interval that is reliable enough to indicate that the hazard is under control. Statistically designed data collection or sampling systems lend themselves to this purpose. When using statistical process control, it is important to recognize that critical limits must not be exceeded.

Most monitoring procedures for CCPs need to be done rapidly, because they relate to an on-line process and there is no time for lengthy analytical testing. Microbiological testing is seldom, if ever, effective for monitoring CCPs because

of the time required to conduct tests. Therefore, physical and chemical measurements are preferred, because they may be done rapidly and can indicate conditions of microbiological control in the process.

The following areas must be addressed when considering monitoring/inspection: monitoring/inspection controls, procedures, frequency, responsibility, customized contingency plans, monitoring activities, and exceeding the limit. Design of HACCP systems is the most important feature of developing effective monitoring systems. Judgment and discretion are of key importance in designing the CCP and the monitoring system.

I. Step 9: Corrective Actions (Principle 5)

Corrective actions are procedures to be followed when a deviation occurs. Because of variations in CCPs for different dairy products and the diversity of possible deviations, specific corrective action plans must be developed for each CCP. The actions must demonstrate that the CCP has been brought under control. Individuals who have a thorough understanding of the dairy process, product, and HACCP plan should be assigned responsibility for taking corrective action. Corrective action procedures must be documented in the HACCP plan.

Actions taken should eliminate actual or potential hazards created by deviation, develop specific corrective actions for each CCP, assure safe disposition of the dairy product involved, and demonstrate that the CCP has been brought under control.

Responsibilities include placing the dairy product on “hold” pending completion of corrective action. If difficult to establish, the effect of deviation on safety, testing, and final disposition of the dairy product must be agreed to by appropriate individuals; records that identify deviant lots and corrective action must be part of records and records must be kept for a reasonable period after the expected end of shelf life of the dairy product.

J. Step 10: Records (Principle 6)

The requirement for records is similar to low-acid canned food requirements. Generally, records used in the total HACCP system include a listing of the HACCP team and assigned responsibilities; description of the dairy product and its intended use; flow diagram for the entire dairy manufacturing process indicating CCPs, hazards associated with each CCP, and preventive measures; critical limits; monitoring system; corrective action plans for deviations from critical limits; records for all CCPs; and procedures for verification of the HACCP system.

K. Step 11: Verification (Principle 7)

Verification consists of use of methods, procedures, or tests in addition to those used in monitoring to determine that the HACCP system is in compliance with the HACCP plan and/or whether the HACCP plan needs modification and revalidation. Verification involves the following:

1. The scientific or technical process to verify that critical limits at CCPs are satisfactory. This consists of a review of the critical limits to verify that they are adequate to control hazards that are likely to occur.
2. Ensuring that the HACCP plan is functioning effectively. Rather than relying on endproduct sampling, firms must rely on frequent reviews of their HACCP plan, verification that the HACCP plan is being correctly followed, review of CCP records, and determinations that appropriate risk management decisions and dairy product dispositions are made when process deviations occur.
3. Documented periodic revalidations, independent of quality audits or other verification procedures, that must be done to ensure accuracy of the HACCP plan.

Verification inspections should be conducted routinely or on an unannounced basis (a) to assure selected CCPs are under control, (b) when intensive coverage of a specific commodity is needed because of new information concerning dairy food safety, (c) when dairy foods produced have been implicated as a vehicle of foodborne disease, (d) when requested on a consultive basis or established criteria have not been met, and (e) to verify that changes have been implemented correctly after the HACCP plan has been modified.

Verification reports should include (a) information about existence of an HACCP plan and persons responsible for administering and updating the HACCP plan, (b) status of records associated with CCP monitoring, (c) direct monitoring data of the CCP while in operation, (d) certification that monitoring equipment is properly calibrated and in working order, (e) deviations and corrective actions, (f) any samples analyzed to verify that CCPs are under control (analyses may involve microbiological, chemical, physical, or organoleptic methods), (g) modifications to the HACCP plan, and (h) training and knowledge of individuals responsible for monitoring CCPs.

L. Step 12: Evaluating and Revising HACCP Systems

A full review should take place at least annually and should include validation and assessment of CCP. Other situations that trigger evaluation include (a)

new potential hazards for the dairy food such as newly recognized pathogens and new CCPs, (b) when an existing HACCP is out of date, (c) when records are not available, and (d) if changes in production occur and problems are discovered. Another situation that may trigger evaluation is the response to new dairy product development such as raw material change; preparation and processing change; formulation change; packaging change; distribution, storage or display system change; or new use of the dairy product by consumers. The response to a manufacturing change may also trigger evaluation if there are changes in dairy product flow in a plant, equipment changes, shift changes, especially if they affect cleaning, and changes in storage or distribution.

VII. EMPLOYEE EDUCATION AND TRAINING

Product safety systems are people programs. Training people is an essential part of safety systems. Employees must develop an awareness of safety and create a proactive environment for dairy product safety. Successful introduction of a safety system needs to be accompanied by both education and training. Information and training needs of staff vary and should be an ongoing process, not a one-time event.

As stated previously, any safety system must have the full support of top-level management who will need to be briefed about positive benefits of using this approach to assure product safety. This briefing should include resource implications, especially in terms of time input, person power, and staff training requirements, during the setting up and subsequent operating of the system. Other managers and staff, whether or not they are involved directly in the safety system program, need to be briefed in general terms about the reasons for this approach and their likely role in the resulting safety system. At the very least, managers and staff should be made aware of reasons for such a new approach. All personnel need to be kept informed of progress during development of safety systems that involve their work, and this may be done via information sheets, meetings, and workshops among other modes.

Team members need training in (a) principles of HACCP; (b) approaching the analysis logically, systematically, and thoroughly; (c) benefits of the HACCP system; and (d) role that the team plays in dairy product safety. Production staff managers, supervisors, engineers, and operators need training on two levels to enable them to carry out their parts in changes that result from a safety system program. The first level involves how application of the safety system program will affect an individual's work. For example, staff who monitor CCPs need to

know what corrective actions to take when a control measure fails (exceeds the specified tolerances) or moves toward failure. Training may also be needed to interpret data produced when monitoring is done. The second level involves specific training in technical skills, for example, taking an accurate and relevant temperature measurement.

Both team members and production staff need to understand that team meetings, verification audits, and changes arising from findings of these audits all form part of the safety system and are all aimed at achieving the objective of the program in the most effective way. It is suggested that dairy plant personnel be trained in four distinct groups: (a) senior management, (b) HACCP coordinator, (c) HACCP team member, and (d) on-line personnel. Senior management should have general knowledge of HACCP principles and the safety system plan. Both the HACCP coordinator and the HACCP team members should have a broad and detailed understanding of HACCP principles and the safety system plan. On-line employees need to know the importance of specific CCPs, and new personnel need to be made familiar with the safety system and be equipped with the necessary skills to carry out their role within it. This information should be conveyed during induction training.

VIII. MODEL HACCP PROGRAMS

Generic HACCP plans can serve as useful guidelines; however, it is essential that the unique conditions within each dairy facility be considered during development of an HACCP plan. Subtle differences in product raw materials and manufacturing require managers to examine CCPs line-by-line and plant-by-plant.

The following model/generic HACCP plan has been developed to serve as a guideline upon which individuals can build their HACCP programs. A hazard analysis chart (Table 1), flow diagram (Fig. 1), and description chart (Table 2) are included. Simple and straightforward are the keys to a successful HACCP plan. If modifications are necessary, only safety issues should be considered if new CCPs are added.

The fluid milk model program is based on a typical high-temperature, short-time system and includes CCPs that were developed to address raw milk receiving, storage, pasteurization, and vitamin addition. A hazard analysis should be conducted if any changes are made to the program to determine whether the change creates a hazard. This model program could also be used for flavored milk products by including additional elements for nondairy ingredient receiving and storage to the flow chart. Other fluid products such as half and half or cream could follow a similar flow chart.

Table 1 Hazard Analysis Chart: Fluid Milk

Process Step	Identified Hazard	Preventive Measures	CCP
Raw milk receiving	Microbiological (M)—Pathogens, <i>Staphylococcus</i> toxin	Pathogens are eliminated by pasteurization. Temperature control is necessary to prevent <i>Staphylococcus</i> toxin production. Testing is necessary to prevent presence of drug residues.	Yes (M, C)
Filter	Chemical (C)—Animal drug residues Physical—presence of any foreign object that may remain in finished product	System prevents passage of a foreign object large enough to be a hazard.	No
Raw milk storage	Microbiological—Pathogens, <i>Staphylococcus</i> toxin	Pathogens are eliminated by pasteurization. Temperature control is necessary to prevent <i>Staphylococcus</i> toxin production.	Yes (M)
Clarifier/separator	Microbiological—Pathogens, <i>Staphylococcus</i> toxin	Pathogens are eliminated by pasteurization. Resident time not adequate for <i>Staphylococcus</i> toxin production.	No
Raw cream storage	Microbiological—Pathogens, <i>Staphylococcus</i> toxin	Pathogens are eliminated by pasteurization. Temperature control is necessary to prevent <i>Staphylococcus</i> toxin production.	Yes (M)

Homogenation	Microbiological—Pathogens, <i>Staphylococcus</i> toxin	Pathogens are eliminated by pasteurization. Resident time not adequate for <i>Staphylococcus</i> toxin production.	No
Vitamin addition	Microbiological—Pathogens, <i>Staphylococcus</i> toxin Chemical—Toxic levels of vitamin A and/or D	Prerequisite programs are in place for ingredient receiving. Usage records and proper pump calibration ensure proper addition.	Yes (C)
Pasteurization	Microbiological—Pathogens	Pathogens are eliminated by pasteurization.	Yes (M)
Pasteurized storage	Introduction of pathogen hazards after pasteurization	Prerequisite programs are in place to prevent post-pasteurization contamination.	No
Packaging material	Introduction of pathogens, chemicals, or physical hazards after pasteurization	Prerequisite programs are in place to prevent post-pasteurization contamination.	No
Filler	Introduction of pathogens, chemicals, or physical hazards after pasteurization	Prerequisite programs are in place to prevent post-pasteurization contamination.	No
Cold storage	Properly pasteurized, packaged product contains no hazards	Not applicable.	No
Distribution	Properly pasteurized, packaged product contains no hazards	Not applicable	No

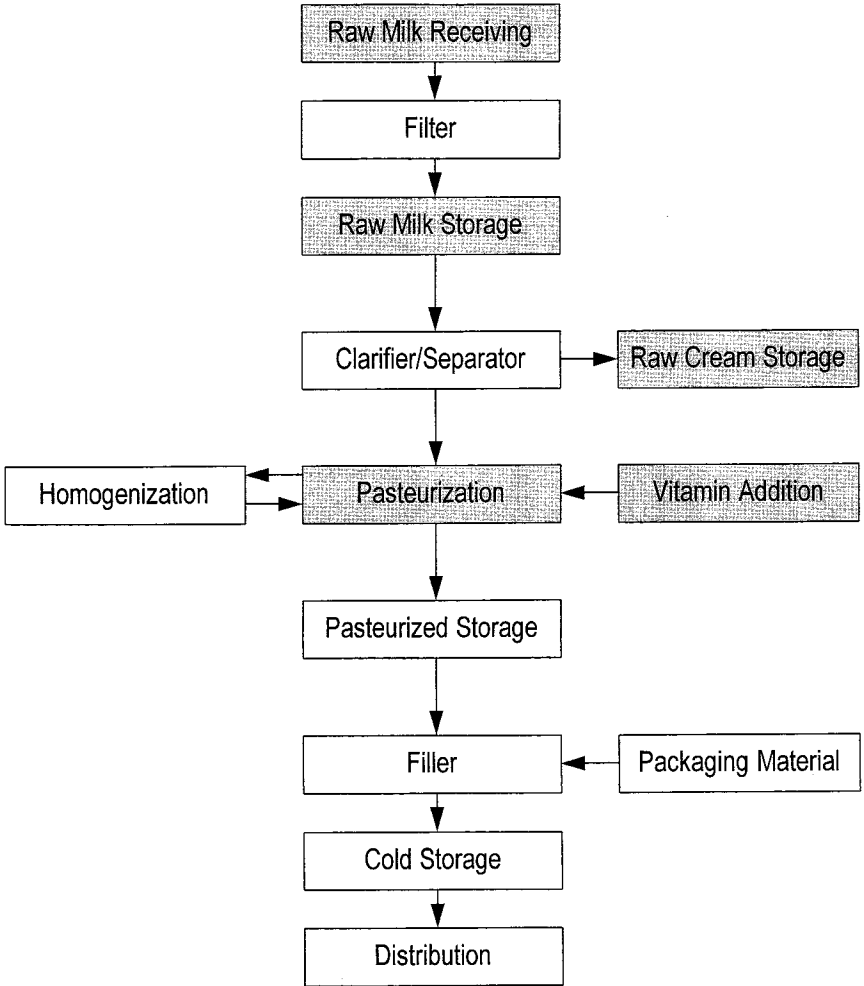

Figure 1 Fluid milk flow diagram.

Table 2 Hazard Analysis Critical Control Point Description Chart for Fluid Milk

CCP/ Process Step	Hazard/ Concern	Control Point	Critical Limit	Monitoring/ Frequency	Records/ Location	Responsibility	Corrective Action	Verification
CCP1: Raw milk re- ceiving	Microbiolog- ical	Temperature	≤45°F (7°C)	Every tanker	Load ticket QA/QC office	Intake op- erator	Hold and evaluate product	Indicating ther- mometer
	Chemical— Drug residues (raw milk)	β-Lactam screening	No positives	Every tanker	Receiving log; QA/ QC office	Intake op- erator	Reject	Calibrate test kit
CCP2: Raw milk storage	Microbiolog- ical	Temperature Time	≤45°F (7°C) ≤72 hr	Continuous but checked four times daily	Recording chart; QA/ QC office	QA tech- nician	Hold product, investigate cause and adjust	Recording vs. indicating ther- mometer
CCP3: Raw cream storage	Microbiolog- ical	Temperature Time	≤45°F (7°C) ≤72 hr	Continuous but checked four times daily	Recording chart; QA/ QC office	QA tech- nician	Hold product, investigate cause and adjust	Recording vs. indicating ther- mometer
CCP4: Vita- min ad- dition	Chemical	Proper con- centrations	<300% of la- bel claim	Daily	Vitamin log; QA/QC office	Pasteurizer operator	Hold product, investigate cause and adjust	Pump calibra- tion, usage records
CCP5: Pasteuri- zation	Microbiolog- ical	Temperature Time	≥161°F (72°C) ≥15 sec	Continuous	Recording chart; pro- duction office	Pasteurizer operator	Flow divert, recirculate, and heat	Cut-in/cut- out checks; indicating thermome- ter cali- bration

REFERENCES

- Anonymous. Pre-requisites Assessment Plan Manual. Cornwall, Ontario, Canada: Cibus Consulting, 1995.
- Anonymous. Dairy Product Safety System Manual. Washington, DC: International Dairy Foods Association, 1996a.
- Anonymous. Title 21, Code of Federal Regulations. Washington, DC: U.S. Government Printing Office, 1996b.
- Pierson MD, Corlett DA Jr, eds. HACCP Principles and Applications, New York: Van Nostrand Reinhold, 1992.

16

Regulatory Control of Milk and Dairy Products

William W. Coleman

*Minnesota Department of Agriculture
St. Paul, Minnesota*

I. INTRODUCTION

“The dairy industry must be the most regulated industry in this country,” is a statement frequently quoted by dairy producers or processors, usually following their latest in a series of regulatory inspections. Most sections of the dairy industry are regulated by multiple agencies, with multiple laws, rules, and regulations, some of which may at times seem to be overlapping or even conflicting. This is because milk and many of its products provide good media to support growth of microorganisms, many of which can cause product spoilage or, of greater concern, endanger public health. It is for the latter reason that regulation of the dairy industry really developed and continues to be so complex.

In the 1800s, many of the larger U.S. cities, to have enough milk to feed their rapidly growing populations, kept herds of thousands of dairy cows, most of which were poorly fed and housed under deplorable conditions. As a result raw milk distributed by these dairies, and consumed mostly by young children, often contained dangerous pathogens which caused diseases such as typhoid fever, scarlet fever, tuberculosis, and diphtheria, just to name a few. With many infants dying as a result of these illnesses, the city and county health departments began to set up rules and regulations to control production facilities and set quality standards for milk sold in their cities. Milk produced in compliance with these early local requirements was often classified as “certified” or “pure.” In some areas, a heating process was required for “drinking” milk, which eventually became known as pasteurization.

Early dairy regulations in the United States were mostly under local health departments and could vary greatly from city to city. Beginning in 1880, there were extensive Congressional investigations and debates concerning the safety and wholesomeness of the United States food supply and the need for federal legislation. It was not until Upton Sinclair's book *The Jungle* (Bantam Books, 1981) was published in 1906 that the federal government took action to establish regulations to control interstate commerce of adulterated food. Although Sinclair's book was written to be more of a statement of his feelings about socialism, it graphically described both the deplorable conditions and adulterated meat being produced in and sold by meat packing plants around Chicago. As a result, the Pure Food and Drug Act of 1906 was passed, and this new law banned from interstate commerce any traffic in adulterated or misbranded food or drugs. This marked the beginning of federal oversight of the food industry in the United States.

II. THE HISTORY OF DAIRY REGULATIONS

The first federal milk ordinance was written by the U.S. Public Health Service (USPHS) in 1924 and was known as the Standard Milk Ordinance. It was a voluntary program intended to help states and local milk control agencies in initiating and maintaining more effective programs for prevention of milkborne diseases. To provide for a uniform interpretation of this Ordinance, an accompanying Code was published in 1927. This Code, through many revisions, eventually led to the current Grade A Pasteurized Milk Ordinance (U.S. Public Health Service, 1999).

The Food, Drug, and Cosmetic Act of 1938 substantially revised and replaced the original Act of 1906. It broadened protection, established standards, required new and more affirmative labeling, prohibited misleading containers, and authorized plant inspections. At the time this Act was passed, milkborne illness outbreaks constituted 25% of all disease outbreaks associated with infected foods and contaminated water, whereas today this rate has dropped to less than 1% (U.S. Public Health Service, 1987). In 1944 the Public Health Service Act was passed and consolidated all previous Public Health Service legislation. It also provided to the Food and Drug Administration (FDA) authority for the Center for Food Safety and Applied Nutrition (CFSAN) with programs for sanitation in milk processing as well as for shellfish, restaurant, and retail market operations. The Factory Inspection Act of 1953 provided FDA the authority for mandatory inspection, which was not clearly stated in the 1938 Act.

Before the Public Health Service Act of 1944, legislation in 1940 had already transferred FDA to the Federal Security Administration, separating it from the United States Department of Agriculture (USDA). Thus began the division

of the U.S. milk supply into two segments, milk for fluid use, designated as grade A milk and under programs of the FDA in CFSAN. The other portion, designated as manufacturing-grade milk remained under USDA and consisted of milk used for butter, cheese, dry milk, evaporated and condensed milk, and other similar dairy products. The first standards for manufacturing grade milk were drafted in 1948 and promulgated in 1949 as the U.S. Sediment Standards for Milk and Milk Products. From 1950 on there was much effort put forth to develop quality standards for manufacturing grade milk, but it was not until 1963 that the proposed standards were published in the *Federal Register* for public comment. Even though they were intended to be minimum standards for voluntary adoption, they continued to create much controversy throughout the industry. In the meantime, USPHS published its new milk ordinance and code in 1965 as the first Pasteurized Milk Ordinance (Publication No. 229). Publication of these two documents brought about a conflict concerning overlapping responsibilities between USDA and FDA. A memorandum of understanding (MOU) was issued in 1969, and the USDA proceeded to publish a revision of the requirements for milk for manufacturing purposes, which eventually led to the publication of the "Milk for Manufacturing Purposes and Its Production and Processing, Recommended Requirements" in the *Federal Register*, Friday April 7, 1972. This document has been continually updated over the years and the most current edition became effective November 12, 1996 (U.S. Department of Agriculture, 1996). The Grade A Pasteurized Milk Ordinance also continued to develop with the 1978 revision being the first published as recommendations of the U.S. Public Health Service/Food and Drug Administration. The latest revision of this publication (No. 229) was published in 1999 (U.S. Public Health Service, 1999) and represents the 30th revision since 1924.

III. NATIONAL CONFERENCE ON INTERSTATE MILK SHIPMENTS (NCIMS)

As World War II intensified during the early 1940s, it became evident that the movement of high-quality milk and dairy products from one state or region to another to support the war effort was difficult because of the costly and time-consuming verification of quality requirement needed from each source. After the war, many of these same problems continued to exist because of relocation of population centers and the need to move more milk. At the same time, these local milk laws and regulations were being used to protect local markets from outside supplies. Without federal economic laws to prevent this, local sanitary regulations were used to prohibit purchase of raw milk outside of that specific area to control and strengthen the welfare of the local industry. This misuse of sanitary regulations was the impetus that led to formation of the National Confer-

ence on Interstate Milk Shipments (NCIMS) (Boosinger, 1983). The first action really occurred in 1944 when the Committee on Interstate Quarantine of the State and Territorial Health Authorities Association passed a motion to have the USPHS publish lists of milk shippers having supplies that were inspected, sampled, and certified as in compliance by state health or other milk control agencies whose rating procedures had been checked and approved by USPHS. This proposal was sent out for comment to the states and territories, and most of those who responded were in favor of developing a program of this type.

Over the next 5 years, planning meetings were held, problems were discussed, and finally the first National Conference on Interstate Milk Shipments was held in St. Louis, Missouri, in June of 1950. Dr. James Rowland, Director of the Missouri Bureau of Food and Drugs under the Division of Health, served as the first chairman and set forth the now familiar objective, "The best possible milk supply for all the people." The first meeting, attended by representatives from 22 states and the District of Columbia, adopted the USPHS's Recommended Milk Ordinance and Code as its basic regulation. Compliance with this standard was to be measured by the USPHS milk sanitation rating method. This remained the basic document as the NCIMS conferences moved forward on an every other year basis beginning in 1953. Subsequent national conferences were held in every odd-numbered year through 1995. Two conferences were held in 1997 to evaluate the progress achieved under the cooperative program, to make constructive improvements, and to clarify operating procedures. A more complete history of the NCIMS can be found in "The History and Accomplishments of the National Conference on Interstate Milk Shipments" (Boosinger, 1983).

The NCIMS operates under an Agreement between the Conference and the FDA, and is in the form of a MOU, which became effective August 5, 1977. This Agreement is based upon principles set forth in the MOU printed in the "Procedures Governing the Cooperative State-Public Health Service/Food and Drug Administration Program for Certification of Interstate Milk Shippers" (U.S. Public Health Service, 1999). This MOU, which is the foundation of the interstate grade A program, is as follows:

- A. The Interstate Milk Shippers Program shall be governed by provisions of the current FDA publication No. 72-2022, "Procedures Governing the Cooperative Federal-State Program for Certification of Interstate Milk Shippers" (Procedures Manual), and by documents referenced therein. Copies of all governing documents are available for review in the office of the FDA Hearing Clerk.
- B. The responsibilities of the NCIMS, participating states, and FDA for execution of the Interstate Milk Shippers Program shall be stated in the above referenced Procedures Manual.

- C. Failure on the part of any certified state milk sanitation rating officer, state milk laboratory survey office, or state sampling surveillance officer to comply with the provisions of this Memorandum or the Procedures Manual shall be sufficient cause for FDA to proceed to a hearing to provide said rating officer, laboratory survey officer, or sampling surveillance officer an opportunity to show cause why his/her certification or approval should not be revoked.
- D. It shall be the right of the NCIMS and each participating state to request and receive consultation with the appropriate representatives of the FDA to discuss provisions of this Memorandum or problems encountered in execution of provisions of the Procedures Manual. The initial contact office at FDA for all inquiries pertaining to the Program is the Bureau of Foods (now Center for Food Safety and Applied Nutrition, Milk Safety Branch—HFS-626), FDA, 200 C Street SW, Washington, DC 20204.
- E. It shall be the right of the FDA to request and receive consultation with appropriate officials of the NCIMS or any of its member states to discuss the provisions of this Memorandum or problems encountered in execution of provisions of the Procedures Manual. The Executive Board of NCIMS can be contacted by FDA personnel through the Milk Safety Branch at the address indicated in paragraph D, above.
- F. Problems of interpretation regarding provisions of the Procedures Manual and documents referenced therein, or their application, shall be subject to resolution by mutual agreement of the parties.
- G. Changes in provisions of the Procedures Manual and documents referred to therein, shall be mutually concurred on by NCIMS and FDA.
- H. This Memorandum of Understanding may be modified by mutual consent of the parties and may be terminated by either party upon thirty (30) days advanced written notice to the other. Any modification or notice of termination will be published in the *Federal Register*.

The above MOU is the basis for the operation of the NCIMS and provides for the Constitution and Bylaws under which the Conference operates. The complete set of these documents can be found in the Procedures Manual (U.S. Public Health Service, 1999).

Any person interested may attend the NCIMS by registering and paying the required fee. Participation as a voting member is restricted to certified delegates who are representatives of the state rating, and/or state enforcement agencies or like representatives from the District of Columbia, participating U.S. Trust Territories, and each participating non-U.S. country or political subdivision. The NCIMS is governed by an Executive Board, which is elected by the voting delegates at the biennial meeting. This Board is composed of 22 members as follows:

Group I consists of four members from the eastern states. One each from a state rating agency, state enforcement agency, an industry representative, and from a state health agency or other state enforcement body. One at large member is also appointed by the Commissioner to represent the FDA.

Group II consists of four members from the central states. One from each of the same type of agencies or bodies set forth in Group I plus one at large member from an educational institute and one member from a laboratory.

Group III consists of four members from the western states. One from each of the same type of agencies or bodies set forth in Groups I and II plus one at large member appointed by the Secretary of Agriculture to represent the USDA.

Representatives from any other participating territories, countries, or political subdivisions are assigned to either Groups I, II or III by the Executive Board.

The Executive Board elects a Chairperson and a Vice Chairperson from its membership after each biennial meeting. The immediate Past Chairperson of the Board continues to serve as a member of the current Board. The Board also retains the services of an Executive Secretary. This Executive Board manages the affairs of the NCIMS and acts for the Conference on emergency matters deemed appropriate by FDA and/or the members of this Board. The NCIMS Web site can be accessed at www.ncims.org.

A. Operation of an NCIMS Biennial Conference

A Program Committee and Chairperson are appointed by the Chairperson of the Executive Board to organize the biennial meeting of the NCIMS. This committee solicits proposals for changes, additions, or deletions to the PMO, and related documents as well as to the Constitution and Bylaws. They will then arrange all submitted proposals in accordance with their subject matter and assign them to one of three Councils. They may also assign them to specific committees, which have been established by the Executive Board (e.g., Laboratory, Technical, Drug Residue), for their consideration and specific recommendations back to a Council. The structure of the Councils is set forth in the Bylaws of the NCIMS which are printed in the Procedures Manual (U.S. Public Health Service, 1999).

The Chairperson of the Executive Board appoints a Chairperson and a Vice Chairperson for each Council, alternating them between regulatory and industry. The three Councils are made up of 20 members each, 10 representing state rating or enforcement and 10 representing industry. The industry representatives are to

be divided evenly between producers and processors. These industry persons are usually recommended to the Council Chairperson by either the International Dairy Foods Association (IDFA) for dairy processors or by the National Milk Producers Federation (NMPF) for dairy producers. The Chairperson of the Executive Board also appoints a consultant to each Council, as does the FDA, and these individuals act as advisors only and do not vote.

Each of the Councils is set up to deal with specific subject matter and sections of the Procedures Manual. Council I handles laws and regulations plus Section I and II of the Procedures Manual. Council II handles responsibilities of the Conference participants as to reciprocity and cooperation plus Sections V and VI of the Procedures Manual. Council III handles the application of Conference agreements and the Constitution and Bylaws plus Sections III, IV, VII, and VIII of the Procedures Manual. Each Council then deliberates on their assigned proposals and the Council Chairpersons report their action or no-action votes and recommendations back to the certified voting delegates in the General Assembly for final delegate action.

Any attendee at the Conference may speak for or against any proposal after being recognized and asked to speak by either a Council member or delegate of the General Assembly. Voting, however, is limited to appointed members of a Council and final action only to certified delegates in the General Assembly. The one vote given to each state or other participating delegate in the General Assembly may be split in half if there are two agencies responsible for the grade A program in a state or territory.

If a proposal receives no action in a Council, it may be brought to the floor of the General Assembly for further consideration, by a delegate as a minority report, for action by the delegates of the General Assembly. Otherwise it will be voted no-action by the Conference. Proposals moved forward by positive action of the three Councils will be discussed and voted on by the certified delegates in the General Assembly and their action or no-action will determine which proposals will be sent to the FDA for its deliberation and concurrence or nonconcurrence.

If upon its deliberation, the FDA feels that any of the NCIMS approved proposals do not meet what they consider to be the intent of the PMO or its related documents they can decide to not concur and the change set forth in that proposal will not be allowed to take effect. Once the NCIMS Executive Board and the FDA have discussed their differences and agreed upon concurrence, those changes to the PMO or related documents will become effective in 60 days or on a later date as may have been set up in one or more of the proposals.

Although this may appear to be a somewhat cumbersome process, the NCIMS has worked well to keep the PMO and its related documents fairly well up-to-date. However, with technology advancing at such an accelerated rate, the

question continually arises as to the ability of the PMO, in its current form, to meet the future needs of the dairy industry.

B. Grade A Pasteurized Milk Ordinance (PMO)

Currently, the PMO serves as the regulating document for over 97% of the U.S. milk supply. This figure represents only milk produced at the farm and does not indicate what will eventually end up in grade A products. Many of the manufacturing-grade products, especially cheese, will also be made from milk which, although produced on a grade A farm, was received and processed in a non-grade A plant. Processing plants may be under manufacturing-grade regulations and inspection but their milk supply will quite often be rated under the Interstate Milk Shipper (IMS) program as being a grade A supply for purposes of interstate commerce under the PMO.

The PMO provides a regulatory program which each of the states and some territories have adopted either by reference or in a similar form in their statutes, laws, or regulations. Enforcement of requirements of the PMO is therefore a function of a state or local milk control or health agency. Oversight by the FDA is through the IMS Program, which is published in "Methods of Making Sanitation Ratings of Milk Shippers" (U.S. Public Health Service, 1999). Through this program State Rating Officers, trained and certified by the FDA, evaluate and rate the inspection and enforcement activities of state or local milk regulatory agencies. Milk supplies or plants that fail to pass one of these ratings must correct the noted problems and be reinspected, as provided for in the Procedures Manual, or they will lose the grade A status for that plant or supply and may no longer be able to ship those affected products as grade A in interstate commerce. The FDA publishes a quarterly publication "IMS List, Sanitation Compliance and Enforcement Ratings of Interstate Milk Shippers" (U.S. Public Health Service) which lists the compliance rating and status of all grade A plants and milk supplies by state and plant number.

In today's market, losing grade A status can cause a plant serious economic problems because of the large amount of grade A milk and dairy products that moves across state lines. Therefore, it is important for producers and processors to keep up-to-date on changes agreed upon by the NCIMS and FDA and enforced by their local milk regulatory agency. There are three national associations which have taken a lead role in this activity: the American Dairy Products Institute (ADPI), the International Dairy Foods Association (IDFA), and the National Milk Producers Federation (NMPF). These organizations have been very active in the NCIMS and also provide training opportunities and publications for their members to keep them up-to-date on matters related to milk regulations and changes in the PMO.

The PMO is a detailed document designed to provide state and/or local

regulatory agencies with a printed ordinance that can be adopted as a legal regulatory instrument. It is almost 300 pages long with two main parts and a number of appendices. Part I is the unabridged form of the Ordinance, which would be the format required for adoption by a state or local agency. Part II contains the Ordinance, the public health reasons for each requirement, and the administrative procedures that are designed to unify the interpretation of the Ordinance and, for sanitation requirements, provide details as to methods of sanitation compliance. There are 16 appendices containing explanatory material on various aspects of milk sanitation technology and administration. Some of the appendices also provide for mandatory compliance with specific provisions and constitute legal requirements for the PMO.

Contained within the PMO also are chemical, bacteriological, and temperature requirements for grade A milk and milk products (Table 1). No state can legislate standards that are less stringent than those in the PMO, but some states do have more stringent requirements, such as for number of somatic cells. Enforcement procedures are usually fairly uniform between states. If two of the last four product samples are out of compliance, a warning letter is issued. Following that, if three of the last five product samples are out of compliance, further regulatory action will be taken. The PMO requires grade A milk and milk products to be sampled at least four times in 6 months, but most states take regulatory samples at least monthly.

The PMO itself is divided into 18 sections, with many being divided between “r” when pertaining to raw milk and “p” when for pasteurized milk: 1—Definitions; 2—Adulterated or Misbranded Milk or Milk Products; 3—Permits; 4—Labeling; 5—Inspection of Dairy Farms and Plants; 6—Examination of Milk and Milk Products; 7—Standards for Milk and Milk Products; 8—Animal Health; 9—Milk and Milk Products Which May Be Sold; 10—Transferring, Delivery Containers, Cooling; 11—Milk and Milk Products From Beyond the Limits of Routine Inspection; 12—Future Dairy Farms and Milk Plants; 13—Personnel Health; 14—Procedure When Infection or High Risk of Infection Is Discovered; 15—Enforcement; 16—Penalty; 17—Repeal and Date of Effect; 18—Separability Clause.

Under Section 7r are the “Sanitation Requirements for Grade A Raw Milk for Pasteurization, Ultra-pasteurization or Aseptic Processing,” which contain 19 items to be addressed when evaluating the raw milk supply; these are outlined in the “Dairy Farm Inspection Report” (Fig. 1). Following those under Section 7p are the “Sanitation Requirements for Grade A Pasteurized, Ultra-pasteurized and Aseptically Processed Milk and Milk Products,” which contain 22 items to be addressed when evaluating milk processing plants and pasteurized products; these are outlined in the “Milk Plant Inspection Report” (Fig. 2). An important part of the plant inspection is evaluation and inspection of the pasteurization system. The “Milk Plant Equipment Test Report” (Fig. 3) is used to record these

Table 1 Grade A Chemical, Bacteriological, and Temperature Standards from the PMO (USPH, 1997)

Grade A raw milk and milk products for pasteurization, ultrapasteurization or aseptic processing	Temperature	Cooled to 7°C (45°F) or less within 2 h after milking: provided that the blend temperature after the first and subsequent milkings does not exceed 10°C (50°F).
	Bacterial limits	Individual producer milk not to exceed 100,000/mL prior to commingling with other producer milk. Not to exceed 300,000/mL as commingled milk prior to pasteurization.
	Drugs	No positive results on drug residue detection methods as referenced in Section 6—Laboratory Techniques.
	Somatic Cell Count ^a	Individual producer milk: Not to exceed 750,000/mL.
Grade A pasteurized milk and milk products and bulk shipped heat-treated milk products	Temperature	Cooled to 7°C (45°F) or less and maintained thereat.
	Bacterial limits ^b Coliform ^d	20,000/mL, or gm ^c . Not to exceed 10/mL. Provided that in the case of bulk-milk transport, tank shipments shall not exceed 100/mL.
	Phosphatase ^d	Less than 1 µg/mL by the Scharer Rapid Method. Less than 350 mU/L for fluid products and less than 500 for other milk products by the fluorometer or Charm ALP or equivalent.
	Drugs ^b	No positive results on drug residue detection methods as referenced in Section 6—Laboratory Techniques, which have been found to be acceptable for use with pasteurized and heat-treated milk and milk products.
Grade A aseptically processed milk and milk products	Temperature	None.
	Bacterial limits	No growth by test specified in Section 6.
	Drugs ^b	No positive results on drug residue detection methods as referenced in Section 6—Laboratory Techniques, which have been found to be acceptable for use with aseptically processed milk and milk products.

^a Goat's milk 1000,000/mL.^b Not applicable to cultured products.^c Results of the analysis of dairy products which are weighed in order to be analyzed will be reported in # per gram (see the current edition of the *Standard Methods for the Examination of Dairy Products*).^d Not applicable to bulk-shipped heat-treated milk products.

Source: USPH, 1997.

results during the quarterly plant inspection. The State Training Branch of FDA has published a course manual “Milk Pasteurization Controls And Tests” (U.S. Public Health Service, 1993) which describes approved types of pasteurization systems and proper testing methods.

The principle behind these grade A inspection reports is to provide a check sheet to review periodically (semiannually for farms, quarterly for plants) those areas or conditions that are most likely to cause milk to become contaminated or adulterated during production or processing. Out of compliance items are marked and correction is required, or if conditions are found to be serious enough, a farm may be taken off the market or a plant shut down until the problem is corrected. The most critical items on a farm are temperature of milk, health of cows (antibiotic contamination), and bacterial content of milk, or any factors impacting on these main points. In a plant, the most critical items are pasteurization, cross contamination between raw and pasteurized products, postpasteurization contamination, and product temperature, or any factors impacting on these main points.

The PMO and its overview by the NCIMS in conjunction with the FDA provides a uniform system for grade A dairy inspection and enforcement throughout the United States. With movement to incorporate the principles of Hazard Analysis Critical Control Point (HACCP) into the PMO (see Chap. 15), it should even better serve future needs of the dairy industry.

C. PMO-Related Documents and Programs

The PMO is the main regulatory document, but there are other programs designed to work in conjunction with it and cover such areas as sampling, laboratory certification, and other grade A products. These programs are outlined in the Procedures Manual and detailed in other documents as follows:

1. Grade A Condensed and Dry Milk Ordinance (DMO)

The DMO (U.S. Public Health Service, 1995) was developed as a supplement to the PMO specifically to cover the manufacture of condensed milk, dry milk, and whey products intended for use in commercial preparation of grade A pasteurized milk products. The NCIMS recognized the need for such a document to reflect more accurately sanitary quality comparable to grade A market milk, which would be different from that required under recommended manufacturing-grade regulations. The format of the DMO is similar to the PMO, and deviations in content relate mostly to practices that are specific to the condensing and drying process. It is intended to cover production of condensed milk, dry milk, and whey products that are acceptable to state and local regulatory agencies for use in processing grade A pasteurized milk products.

DAIRY FARM INSPECTION REPORT

INSPECTING AGENCY

NAME AND LOCATION OF DAIRY FARM

Pounds Sold Daily

Plant

Permit No.

Inspection of your farm today showed violations existing in the items checked below. You are further notified that this inspection sheet serves as notification of the intent to suspend your permit if the violations noted are not in compliance at the time of the next inspection. (See Sections 3 and 5 of the Grade A Pasteurized Milk Ordinance - Recommendations of the U.S. Public Health Service/Food and Drug Administration.)

COWS

1. Abnormal Milk:

- Cows secreting abnormal milk milked last or in separate equipment (a) _____
- Abnormal milk properly handled and disposed of (b) _____
- Proper care of abnormal milk handling equipment (c) _____

MILKING BARN, STABLE, OR PARLOR

2. Construction:

- Floors, gutters, and feed troughs of concrete or equally impervious materials; in good repair (a) _____
- Walls and ceilings smooth, painted or finished adequately; in good repair; ceiling dust-tight (b) _____
- Separate stalls or pens for horses, calves, and bulls no overcrowding (c) _____
- Adequate natural and/or artificial light; well distributed (d) _____
- Properly ventilated; (e) _____

3. Cleanliness:

- Clean and free of litter (a) _____
- No swine or fowl (b) _____

4. Cowyard:

- Graded to drain; no pooled water or wastes (a) _____
- Cowyard clean; cattle housing areas & manure packs properly maintained (b) _____
- No swine (c) _____
- Manure stored inaccessible to cows (d) _____

Cleaning Facilities

- Two-compartment wash and rinse vat of adequate size (a) _____
- Suitable water heating facilities (b) _____
- Water under pressure piped to milkhouse (c) _____

6. Cleanliness:

- Floors, walls, windows, tables, and similar non-product contact surfaces clean (a) _____
- No trash, unnecessary articles, animals or fowl (b) _____

TOILET AND WATER SUPPLY

7. Toilet:

- Provided; conveniently located (a) _____
- Constructed and operated according to *Ordinance* (b) _____
- No evidence of human wastes about premises (c) _____
- Toilet room in compliance with *Ordinance* (d) _____

8. Water Supply:

- Constructed and operated according to *Ordinance* (a) _____
- Complies with bacteriological standards (b) _____
- No connection between safe and unsafe supplies; no improper submerged inlets (c) _____

TRANSFER AND PROTECTION OF MILK

14. Protection From Contamination:

- No overcrowding (a) _____
- Product and CIP circuits separated (b) _____
- Improperly handled milk discarded (c) _____
- Immediate removal of milk (d) _____
- Milk and equipment properly protected (e) _____
- Sanitized milk surfaces not exposed to contamination (f) _____
- Air under pressure of proper quality (g) _____

15. Drug and Chemical Control

- Cleaners and sanitizers properly identified (a) _____
- Drug administration equipment properly handled and stored (b) _____
- Drugs properly labeled (name and address) and stored (c) _____
- Drugs properly labeled (directions for use, cautionary statements, active ingredient) (d) _____
- Drugs properly used and stored to preclude contamination of milk (e) _____

PERSONNEL

16. Hand-Washing Facilities:

- Proper hand-washing facilities convenient to milking operations (a) _____
- Wash and rinse vats not used as hand-washing facilities (b) _____

17. Personnel Cleanliness:

- Hands washed clean and dried before milking, or performing milk house functions; rewashed when contaminated (a) _____
- Clean outer garments worn (b) _____

MILKHOUSE OR ROOM

5. Construction and Facilities:

Floors

- Smooth, concrete or other impervious material in good repair (a) _____
 Graded to drain (b) _____
 Drains trapped, if connected to sanitary system (c) _____

Walls and Ceilings

- Approved material and finish (a) _____
 Good repair (windows, doors, and hoseport included) (b) _____

Lighting and Ventilation

- Adequate natural and/or artificial light; properly distributed (a) _____
 Adequate ventilation (b) _____
 Doors and windows closed during dusty weather (c) _____
 Vents and lighting fixtures properly installed (d) _____

Miscellaneous Requirements

- Used for milkhouse operations only; sufficient size (a) _____
 No direct opening into living quarters or barn, except as permitted by Ordinance (b) _____
 Liquid wastes properly disposed of (c) _____
 Proper hoseport where required (d) _____
 Acceptable surface under hoseport (e) _____
 Suitable shelter for transport truck as required by this Ordinance (f) _____

UTENSILS AND EQUIPMENT

9. Construction:

Smooth, impervious, nonabsorbent, safe materials; easily

- cleanable; seamless hooded pails (a) _____
 In good repair; accessible for inspection (b) _____
 Approved single-service articles; not reused (c) _____
 Utensils and equipment of proper design (d) _____
 Approved CIP milk pipeline system (e) _____

10. Cleaning:

- Utensils and equipment clean (a) _____

11. Sanitization:

- All multi-use containers and equipment subjected to approved sanitization process (See Ordinance) (a) _____

12. Storage:

- All multi-use containers and equipment properly stored (a) _____
 Stored to assure complete drainage, where applicable (b) _____
 Single-service articles properly stored (c) _____

MILKING

13. Flanks, Udders, and Teats:

- Milking done in barn, stable, or parlor (a) _____
 Brushing completed before milking begun (b) _____
 Flanks, bellies, udders, and tails of cows clean at time of milking; clipped when required (c) _____
 Teats treated with sanitizing solution and dried, just prior to milking (d) _____
 No wet hand milking (e) _____

COOLING

18. Cooling:

- Milk cooled to 45 F or less within 2 hours after milking, except as permitted by Ordinance (a) _____
 Recirculated cooling water from safe source and properly protected; complies with bacteriological standards (b) _____

PEST CONTROL

19. Insect and Rodent Control:

- Fly breeding minimized by approved manure disposal methods (See Ordinance) (a) _____
 Manure packs properly maintained (b) _____
 All milkhouse openings effectively screened or otherwise protected; doors tight and self-closing; screen doors open outward (c) _____
 Milkhouse free of insects and rodents (d) _____
 Approved pesticides; used properly (e) _____
 Equipment and utensils not exposed to pesticide contamination (f) _____
 Surroundings neat and clean; free of harborage and breeding areas (g) _____
 Feed storage not attraction for birds, rodents or insects (h) _____

REMARKS

DATE

SANITARIAN

Figure 1 Grade A dairy farm inspection report, FDA form 2359a. (USPH, 1997)

DEPARTMENT OF HEALTH AND HUMAN SERVICES
Public Health Service
Food and Drug Administration

MILK PLANT INSPECTION REPORT
(Includes Receiving Stations, Transfer Stations,
and Bulk Tank Cleaning Facilities)

Inspecting Agency _____

Name and Location of Plant: _____

POUNDS SOLD DAILY

Milk _____

Other Milk _____

Products _____

Total _____

Permit No. _____

Inspection of your plant today showed violations existing in the items checked below. You are further notified that this inspection sheet serves as notification of the intent to suspend your permit if the violations noted are not in compliance at the time of the next inspection. (See sections 3 and 5 of the **Grade A Pasteurized Milk Ordinance - Recommendations of the U.S. Public Health Service/Food and Drug Administration.**)

<p>1. FLOORS: Smooth; impervious; no pools; good repair; trapped drains (a) _____</p> <p>2. WALLS AND CEILINGS: Smooth; washable; light-colored; good repair (a) _____</p> <p>3. DOORS AND WINDOWS: All outer openings effectively protected against entry of flies and rodents (a) _____ Outer doors self-closing; screen doors open outward (b) _____</p> <p>4. LIGHTING AND VENTILATION: Adequate in all rooms (a) _____ Well ventilated to preclude odors and condensation; filtered air with pressure systems (b) _____</p> <p>5. SEPARATE ROOMS: Separate rooms as required; adequate size (a) _____ No direct opening to barn or living quarters (b) _____ Storage tanks properly vented (c) _____</p> <p>6. TOILET FACILITIES: Complies with local ordinances (a) _____ No direct opening to processing rooms; self-enclosing doors (b) _____ Clean; well-lighted and ventilated; proper facilities (c) _____ Sewage and other liquid wastes disposed of in sanitary manner (d) _____</p>	<p>13. STORAGE OF CLEANED CONTAINERS AND EQUIPMENT: Stored to assure drainage and protected from contamination (a) _____</p> <p>14. STORAGE OF SINGLE-SERVICE ARTICLES: Received, stored and handled in a sanitary manner, paperboard containers not reused except as permitted by the <i>Ordinance</i> (a) _____</p> <p>15a. PROTECTION FROM CONTAMINATION: Operations conducted and located so as to preclude contamination of milk, milk products, ingredients, containers, equipment, and utensils (a) _____ Air and steam used to process products in compliance with <i>Ordinance</i> (b) _____ Approved pesticides, safely used (c) _____</p> <p>15b. CROSS CONNECTIONS: No direct connections between pasteurized and raw milk or milk products (a) _____ Overflow, spilled and leaked products or ingredients discarded (b) _____ No direct connections between milk or milk products and cleaning and/or sanitizing solutions (c) _____</p> <p>16a. PASTEURIZATION-BATCH: (1) INDICATING AND RECORDING THERMOMETERS: Comply with <i>Ordinance</i> specifications (a) _____</p>	<p>Recorder controller complies with <i>Ordinance</i> requirements (b) _____ Holding tube complies with <i>Ordinance</i> requirements (c) _____ Flow promoting devices comply with <i>Ordinance</i> requirements (d) _____</p> <p>(3) ADULTERATION CONTROLS: Satisfactory means to prevent adulteration with added water (a) _____</p> <p>16d. REGENERATIVE HEATING: Pasteurized or aseptic product in regenerator automatically under greater pressure than raw product in regenerator at all times (a) _____ Accurate pressure gauges installed as required; booster pump properly identified and installed (b) _____ Regenerator pressures meet <i>Ordinance</i> requirements (c) _____</p> <p>16e. TEMPERATURE RECORDING CHARTS: Batch pasteurizer charts comply with applicable <i>Ordinance</i> requirements (a) _____ HTST pasteurizer charts comply with applicable <i>Ordinance</i> requirements (b) _____ Aseptic charts comply with applicable <i>Ordinance</i> requirements (c) _____</p>
---	--	--

7. WATER SUPPLY:

- Constructed and operated in accordance with *Ordinance* (a) _____
- No direct or indirect connection between safe and unsafe water (b) _____
- Condensing water and vacuum water in compliance with *Ordinance* requirements (c) _____
- Complies with bacteriological standards (d) _____

8. HAND-WASHING FACILITIES:

- Located and equipped as required; clean and in good repair; improper facilities not used (a) _____

9. MILK PLANT CLEANLINESS:

- Neat; clean; no evidence of insects or rodents; trash properly handled (a) _____
- No unnecessary equipment (b) _____

10. SANITARY PIPING:

- Smooth; impervious, corrosion-resistant, non-toxic, easily cleanable materials; good repair; accessible for inspection (a) _____
- Clean-in-place lines meet *Ordinance* specifications (b) _____
- Pasteurized products conducted in sanitary piping, except as permitted by *Ordinance* (c) _____

11. CONSTRUCTION AND REPAIR OF CONTAINERS AND EQUIPMENT:

- Smooth, impervious, corrosion-resistant, non-toxic, easily cleanable materials; good repair; accessible for inspection (a) _____
- Self-draining; strainers of approved design (b) _____
- Approved single-service articles; not reused (c) _____

12. CLEANING AND SANITIZING OF CONTAINERS/EQUIPMENT:

- Containers, utensils, and equipment effectively cleaned (a) _____
- Mechanical cleaning requirements of *Ordinance* in compliance; records complete (b) _____
- Approved sanitation process applied prior to use of product-contact surfaces (c) _____
- Required efficiency tests in compliance (d) _____
- Multi-use plastic containers in compliance (e) _____
- Aseptic system sterilized (f) _____

(2) TIME AND TEMPERATURE CONTROLS:

- Adequate agitation throughout holding; agitator sufficiently submerged (a) _____
- Each pasteurizer equipped with indicating and recording thermometer; bulb submerged (b) _____
- Recording thermometer reads no higher than indicating thermometer (c) _____
- Product held minimum pasteurization temperature continuously for 30 minutes, plus filling time if product preheated before entering vat, plus emptying time, if cooling is begun after opening outlet (d) _____
- No product added after holding begun (e) _____
- Airspace above product maintained at not less than 5.0° F higher than minimum required pasteurization temperature during holding (f) _____
- Approved airspace thermometer; bulb not less than 1 inch above product level (g) _____
- Inlet and outlet valves and connections in compliance with *Ordinance* (h) _____

16b. PASTEURIZATION-HIGH TEMPERATURE:

- (1) **INDICATING AND RECORDING THERMOMETERS:**
Comply with *Ordinance* specifications (a) _____

(2) TIME AND TEMPERATURE CONTROLS:

- Flow diversion device complies with *Ordinance* requirements (a) _____
- Recorder controller complies with *Ordinance* requirements (b) _____
- Holding tube complies with *Ordinance* requirements (c) _____
- Flow promoting devices comply with *Ordinance* requirements (d) _____
- (3) **ADULTERATION CONTROLS:**
Satisfactory means to prevent adulteration with added water (a) _____

16c. ASEPTIC PROCESSING:

- (1) **INDICATING AND RECORDING THERMOMETERS:**
Comply with *Ordinance* specifications (a) _____
- (2) **TIME AND TEMPERATURE CONTROLS:**
Flow diversion device complies with *Ordinance* requirements (a) _____

17. COOLING OF MILK:

- Raw milk maintained at 45° F or less until processed (a) _____
- Pasteurized milk and milk products, except those to be cultured, cooled immediately to 45° F or less in approved equipment; all milk and milk products stored thereat until delivered (b) _____
- Approved thermometer properly located in all refrigeration rooms and storage tanks (c) _____
- Recirculated cooling water from safe source and properly protected; complies with bacteriological standards (d) _____

18. BOTTLING AND PACKAGING:

- Performed in a plant where contents finally pasteurized (a) _____
- Performed in a sanitary manner by approved mechanical equipment (b) _____
- Aseptic filling in compliance (c) _____

19. CAPPING:

- Capping and/or closing performed in sanitary manner by approved mechanical equipment (a) _____
- Imperfectly capped/closed products properly handled (b) _____
- Caps and/or closures comply with *Ordinance* (c) _____

20. PERSONNEL CLEANLINESS:

- Hands washed clean before performing plant functions; re-washed when contaminated (a) _____
- Clean outer garments and hair covering worn (b) _____
- No use of tobacco in processing areas (c) _____

21. VEHICLES:

- Vehicles clean; constructed to protect milk (a) _____
- No contaminating substances transported (b) _____

22. SURROUNDINGS:

- Neat and clean; free of pooled water, harborages, and breeding areas (a) _____
- Tank unloading areas properly constructed (b) _____
- Approved pesticides, used properly (c) _____

Remarks:

Date: _____ Sanitarian: _____

DEPARTMENT OF HEALTH AND HUMAN SERVICES
PUBLIC HEALTH SERVICE
FOOD AND DRUG ADMINISTRATION

MILK PLANT EQUIPMENT
TEST REPORT

TEST NO.	TEST	TEST FREQUENCY	TESTED (X or NA)	RESULTS OF TEST <i>(See Reverse for Working Notes)</i>
1.	Indicating thermometers (including air space): Temperature accuracy	3 months		
2.	Recording thermometers: Temperature accuracy	3 months		
3.	Recording thermometers: Time accuracy	3 months		
4.	Recording thermometers: Checked against indicating thermometer	3 months		Daily by operator
5.	Flow diversion device: Proper assembly and function (HTST and HHST)			
5.1	Leakage past valve seat(s)	3 months		
5.2	Operation of valve stem(s)	3 months		
5.3	Device assembly (micro-switch) single stem	3 months		
5.4	Device assembly (micro-switches) dual stem	3 months		
5.5	Manual diversion - Parts (A, B and C) (HTST only)	3 months		
5.6	Response time	3 months		
5.7	Time delay interlock (dual stem devices) (Inspect)	3 months		
5.8	Time delay interlock (dual stem devices) (CIP)	3 months		
5.9	Leak Detect flush time delay (HTST only as applicable)	3 months		
6.	Leak-protect valves: Leakage (Vats only)	3 months		
7.	Indicating thermometers in pipelines: Thermometric response (HTST only)	3 months		
8.	Recorder-Controller: Thermometric response (HTST only)	3 months		
9.	Regenerator Pressure Controls			
9.1	Pressure Switches (HTST only)	3 months		
9.2	Differential pressure controllers			
9.2.1	Calibration	3 months		
9.2.2	Interwiring Booster Pump (HTST only)	3 months		

	9.2.3	Interwiring FDD (HHST and Aseptic)	3 months		
	9.3	Additional Booster Pump interwiring (HTST only)			
	9.3.1	With FDD	3 months		
	9.3.2	With Metering Pump	3 months		
10.	Milk-flow controls: Cut-in and cut out temperatures (10.1, 10.2, <u>or</u> 10.3)		3 months		Daily by operator (HTST)
11.	Timing System Controls				
	11.1	Holding time (HTST except magnetic flow meters)	6 months		Adjusted product holding time if applicable
	11.2.a	Magnetic Flow Meters (HTST only)	6 months		
	11.2.b	Flow Alarm (HTST, HHST, and Aseptic)	6 months		
	11.2.c	Loss of signal alarm (HTST, HHST, and Aseptic)	6 months		
	11.2.d	Flow cut-in/cut out (HTST only)	6 months		
	11.2.e	Time delay (after divert) (HTST only)	6 months		
	11.3	HHST Indirect heating	6 months		
	11.4	HHST Direct Injection heating	6 months		
	11.5	HHST Direct Infusion heating	6 months		
12.	Controller: Sequence logic (HHST and Aseptic) (12.1 or 12.2)		3 months		
13.	Product pressure-control switch setting (HHST and Aseptic)		3 months		
14.	Injector differential pressure (HHST and Aseptic) (Injection heating)		3 months		
Remarks					
PLANT		IDENTITY OF EQUIPMENT	LOCATION	DATE	SANITARIAN

Figure 3 Grade A milk plant equipment test report, FDA form 2359b. (USPH, 1997)

2. Standards for the Fabrication of Single-Service Containers and Closures (SSCC)

The SSCC (U.S. Public Health Service, 1999) provides a means to determine acceptability of manufacturing plants and processors of single-service containers and closures to be used for packaging grade A milk and dairy products. It contains an inspection program designed to prevent contamination of these types of containers during manufacture and before being filled with product. A list of approved plants and processors appears quarterly in the "IMS List, Sanitation Compliance and Enforcement Ratings of Interstate Milk Shippers" (U.S. Public Health Service). Only the listed sources that are currently approved can supply containers or packaging materials for use with grade A products.

The SSCC has been incorporated into the 1999 revision of the PMO, as directed by the 1999 NCIMS, but should also be available again as a separate document.

3. Evaluation of Milk Laboratories (EML)

The EML (U.S. Public Health Service, 1995) is the publication that covers the IMS sampling procedures used to collect milk and milk products, test containers and closures, examine milk and milk products, and test for vitamin content. All sampling and laboratory procedures must conform to those in the latest edition of *Standard Methods for the Examination of Dairy Products* (Marshall, 1992) and/or the *Official Methods of Analysis of the Association of Analytical Chemists* (Cunniff, 1998).

Milk haulers and all other personnel who collect samples of grade A raw milk from individual producers or finished products from plants are required to be evaluated and certified by an FDA-approved State Sampling Surveillance Officer. A detailed evaluation form, FDA form No. 2399 a, is used to certify these individuals (Fig. 4). An evaluation and certification of every sampler is required once in every 24-month period.

Appendix B of the PMO (1999 revision) has been rewritten to cover in more detail the sampling, hauling, and transportation of grade A milk and also the new requirements for bulk milk pick-up tanker permits and inspection.

The EML details a similar evaluation and certification program for grade A milk laboratories. Every laboratory that analyzes grade A milk and/or milk products must be evaluated and certified by a State Laboratory Evaluation Officer once in every 24-month period. Every approved method of analysis used by a laboratory must be evaluated using a separate specialized FDA form No. 2400. Only a portion of one of these forms is shown as an example (Fig. 5), as these forms tend to be quite detailed and can be rather lengthy. Also each laboratory

DEPARTMENT OF HEALTH AND HUMAN SERVICES PUBLIC HEALTH SERVICE FOOD AND DRUG ADMINISTRATION	BULK MILK PICKUP TANKER, HAULER REPORT AND SAMPLER EVALUATION FORM	Permit No. _____ Hauler _____ Tanker _____
Hauler/Sampler _____ Address _____ Owner _____ Address _____ Inspection Location _____ Receiving Plant _____ Daily Pickup No. _____		
An inspection of our bulk milk pickup facilities and/or an evaluation of your sampling procedures has been made. Violations are marked with a cross (X) Two successive violations of the same item in section I or II calls for immediate suspension.		
I. TANKER AND APPURTENCES 1. Construction complies with PMO regulation..... 2. Cleaned after each days use..... 3. Sanitization records/wash tags maintained..... 4. Vehicle properly identified..... II. HAULER SANITATION PROCEDURES 5. Pickup practices conducted to preclude contamination of milk contact surfaces..... 6. Hands clean and dry, no infections..... 7. Clean outer clothing, no use of tobacco..... 8. Hose port used, tank lids closed during completion of pickup..... 9. Hose properly capped between milk pickup operations, hose cap protected during milk pickup..... 10. Hose disconnected before tank rinse..... 10. 11. Observations made for sediment/abnormalities..... 12. Sample collected at every pickup..... III BULK TANK SAMPLING PROCEDURES 13. Thermometer – approved type..... a. Accuracy – Checked against standard thermometer Every 6 months – accuracy (+)/(-) division..... b. Date checked and checker's initials attached to case..... 14. Sample Transfer Instrument a. Clean, sanitized or sterilized and of proper construction and repair..... 15. Sampling Instrument Container a. Proper design, construction and repair for storing Sample dipper in sanitizer..... b. Applicable test kit for checking strength of sanitizer (200 ppm chlorine or equivalent)..... 16. Sample Containers a. Clean, properly sanitized or sterilized..... b. Adequate supply, properly stored or handled..... 17. Sample Storage Case. a. Rigid construction, suitable design to maintain samples at 32°–40°F, protected from contamination..... b. Ample space for refrigerant, racks provided As necessary.....	18. Sample Collection – precautions and procedures a. Sampling instrument and container(s) properly carried into and aseptically handled in milk room..... b. Bulk tank milk outlet valve sanitized before connecting transfer hose..... c. Smell milk through tank port hole..... d. Observe milk in a quiescent state with lid wide open and lights on when necessary..... e. Test thermometer sanitized (1 Min. Contact time)..... f. Non-acceptable milk rejected..... g. Dry measuring stick with single service paper towel..... h. Measure milk only when quiescent..... i. Do not contaminate milk during the measuring process..... j. Agitate milk before sampling at least 5 min. or longer as may be required by tank specifications..... k. Do not open bulk tank valve until milk is measured and sampled..... l. Temperature of milk, time, date of pickup and haulers identification recorded on each farm weight ticket..... m. Tank thermometer accuracy checked monthly and recorded when used as test thermometers..... n. Temperature control sample provided at first sampling Location for each rack of samples..... o. Temperature control sample properly labeled with time, date, temperature, and with producer and hauler identification..... p. Sample containers legibly identified at collection points..... q. Sample dipper rinsed at least two times in the milk before transferring sample..... r. Dipper should extend 6-8 inches into the milk to obtain representative sample..... s. Do not hold sample container over the milk when Transferring sample into the container..... t. Fill sample container no more than ¾ full..... u. Rinse sample dipper in tap water, replace in it's Container, open milk valve and turn on tank pump..... v. Immediately take milk sample to the sample case..... 19. Sample Collection – Storage and Transportation a. Sample storage – refrigerant maintained no higher than milk level in sample containers – maintain sample temperature – do not bury tops of containers in ice protect against contamination..... b. Deliver samples to laboratory promptly..... c. Samples and sample data – submitted to laboratory – if by common carrier, use tamper shipping case with top labeled "This Side Up".....	
Remarks: _____ Date _____ Sanitarian _____ Agency _____		

Figure 4 Grade A bulk milk pickup tanker, hauler report, and sampler evaluation form, FDA form 2399a. (USPH, 1997)

DEPARTMENT OF HEALTH AND HUMAN SERVICES PUBLIC HEALTH SERVICE FOOD AND DRUG ADMINISTRATION MILK LABORATORY EVALUATION FORM	LABORATORY		
	LOCATION		LAB #
EVALUATION BY:	DATE	X = DEVIATION O = NOT USED	U = UNDETERMINED NA = NOT APPLICABLE

STANDARD PLATE COUNT, COLIFORM, AND SIMPLIFIED COUNT METHODS
 [Unless otherwise stated all tolerances are $\pm 5\%$]

SAMPLES

1. Laboratory requirements (see CP Item 33) _____
STANDARD PLATE AND COLIFORM METHODS
DILUTING SAMPLES
2. Work Area _____
 - a. Level plating bench not in direct sunlight _____
 - b. Sanitized immediately before start of plating _____
3. Selecting Dilutions _____
 - a. Standard Plate Count _____
 1. Plate two decimal dilutions per sample _____
 2. Select dilutions to yield one plate with 25-250 colonies _____
 - a. Raw milk is normally diluted to 1:100 and 1:1000 _____
 - b. Finished products are normally diluted to 1:10 and 1:100 _____
 - c. The above are general guidelines and may have to be adjusted on a case by case basis (dilutions below 1:10 not required) _____
 - b. Coliform Counts _____
 1. For milk samples, 1 mL direct and/or decimal dilutions _____
 2. For all other products, distribute 10 mL of a 1:10 dilution among three plates, generally high fat and viscous products _____
4. Identifying Plates _____
 - a. Label each plate with sample identification and dilution _____
 - b. Arrange plates in order before preparation of dilutions _____

DILUTING SAMPLES (Continued)

- i. Blow out last drop of undiluted sample from pipet using pipet aid _____
 1. Blow out away from main part of sample in plate, do not make bubbles _____
- j. Pipets discarded into disinfectant, or if disposable optionally into biohazard bags or containers to be sterilized _____
7. Sample Measurement, pipettors _____
 - a. Each day before use, vigorously depress plunger 10x to redistribute lubrication and assure smooth operation _____
 - b. Before each use examine pipettor to assure that no liquid is expelled from the pipettor nose-cone (contaminated), if fouling is detected do not use until cleaned as per manufacturer recommendation _____
 - c. Use separate sterile tip for the initial transfers from each container _____
 - d. Depress plunger to first stop _____
 - e. Tip/barrel not dragged across lip or neck of sample container, and pipettor barrel not allowed within sample container _____
 - f. Tip not inserted more than 1 cm below sample surface (foam avoided if possible) _____
 - g. With pipettor vertical, slowly and completely release plunger _____
 - h. With tip still below sample surface, depress plunger to first stop again and slowly and completely release plunger and then remove tip from liquid _____

5. Sample Agitation	
a. When appropriate, wipe top of unopened containers with sterile, ethyl alcohol-saturated cloth	
b. Before removal of any portion, thoroughly mix contents of each container	
1. Shake raw and processed sample containers (approx 3/4 full) 25 times in 7 sec with 1 ft movement	
2. Invert filled retail container 25 times, each inversion a complete down and up motion	
c. Remove test portion within 3 min of sample agitation	
6. Sample Measurement, pipets	
a. Use separate sterile pipets for the initial transfers from each container	
1. Pipets in pipet container adjusted without touching the pipets	
b. Pipet tip not dragged over exposed exterior of pipets in container	
c. Pipet not dragged across lip or neck of sample container	
d. Pipet not inserted more than 2.5 cm (1") below sample surface (foam avoided if possible)	
e. Draw test portion above pipet graduation mark and remove pipet from liquid	
1. Pipet aid used, mouth pipetting not permitted	
f. Adjust test volume to mark with lower side of pipet in contact with inside of sample container (above the sample surface)	
g. Drainage complete, excess liquid not adhering to pipet	
h. Release test portion to petri dish (tip in contact with plate, 45° angle) or dilution blank (with lower side of pipet in contact with neck of dilution blank, or dry area above buffer when appropriate) with column drain of 2-4 sec	
	i. Touch tip off to inside of sample container above the sample surface, excess liquid not adhering to tip (do not lay pipettor down once sample is drawn up, use vertical rack if necessary)
	j. Release test portion to petri dish (tip in contact with plate) by slowly depressing plunger to first stop allowing about 1 or 2 seconds for complete drainage
	k. Move tip to a dry spot on plate
	1. If pipettor only has one (1) stop touch off
	2. If pipettor has two (2) stops, depress plunger to second stop and touch off
	l. Or, dispense test portion to dilution blank (tip in contact neck of dilution blank, or dry area above buffer where appropriate) by slowly depressing plunger to first stop allowing about 1 or 2 seconds for complete drainage
	m. If pipettor has two (2) stops, depress plunger to second stop
	n. Tips discarded into disinfectant, or biohazard bags or containers to be sterilized
	8. Dilution Agitation
	a. Before removal of any portion, shake each dilution bottle 25 times in 7 sec with a 1 ft movement
	b. Optionally, use approved mechanical shaker for 15 sec
	c. Remove test portion within 3 min of dilution agitation
	9. Dilution Measurement, pipets
	a. Use separate sterile pipets for the initial transfers from each container
	1. Pipets in pipet container adjusted without touching the pipets
	b. Pipet tip not dragged over exposed exterior of pipets in container
	c. Pipet not dragged across lip or neck of dilution blank

Figure 5 A portion of a grade A milk laboratory evaluation form, as a format example of one of the many FDA 2400 forms used as part of the EML. (USPH, 1995)

analyst must be evaluated and certified for each procedure he/she uses to test grade A milk or milk products once in every 24-month period.

Annually, each certified laboratory receives a set of split milk samples for analysis using the methods that have been certified for the laboratory and its analysts. Submitted results will be compared to those established for split samples by the FDA-certified Official State Laboratory. Laboratories with results outside of the logarithmic mean (rejection limit) for these split samples will have to be recertified to prevent losing their ability officially to test grade A milk and milk products. All currently certified grade A laboratories are also listed in the quarterly publication "IMS List, Sanitation Compliance and Enforcement Ratings of Interstate Milk Shippers" (U.S. Public Health Service).

4. Methods for Making Sanitation Ratings of Milk Supplies (MMSR)

The MMSR (U.S. Public Health Service, 1999) is the document used to determine compliance with sanitation and enforcement procedures contained in the PMO and related documents. The object of a rating is to provide an assessment of state and local regulatory agencies' sanitation activities regarding public health protection and milk quality control, as provided for in the PMO and the Procedures Manual. Rating results provide a means of determining the degree of compliance with public health standards and also provide a basis for acceptance/rejection of milk shippers by public health officials beyond the limits of local routine inspections. These ratings are intended to establish uniform reciprocity between states to prevent unnecessary restrictions on the interstate flow of grade A milk and milk products. These ratings are conducted by State Milk Sanitation Rating Officers who have been trained and certified by the FDA to conduct such ratings in their state or territory. The FDA will also conduct a recertification of each State Milk Sanitation Rating Officer once every 3 years.

IMS ratings are scored on a basis of 100 points, with 90 being the required passing score. However, under certain conditions, as outlined in the MMSR, scores lower than 90 may be acceptable. The exact method of calculating a rating score for a plant or for a milk supply, referred to as a bulk tank unit (BTU), is detailed in the MMSR document. Every grade A plant and/or BTU must be rated once in every 24-month period. If a plant or BTU receives a rating score below 90 or as otherwise allowed by the MMSR, it must be resurveyed and receive a passing score to maintain its grade A status. All grade A plants and BTUs are listed in the quarterly publication "IMS List, Sanitation Compliance and Enforcement Ratings of Interstate Milk Shippers" (U.S. Public Health Service). This publication is arranged by state and plant number and also lists the grade A products approved for each plant along with the current rating score and the most recent date the rating was published.

The FDA conducts a number of annual, random check ratings within each state to review and verify the current rating score that has been assigned to a plant or BTU by a State Milk Sanitation Rating Officer. If the rating score calculated by the FDA in a check rating is below 85 for farms (BTU) or below 81 for plants, then that BTU or plant must be resurveyed by the state within 60 days and found to be in compliance or it will lose its grade A status. These check ratings are done in addition to the regular IMS ratings conducted by the State Rating Officers.

IV. USDA MANUFACTURING-GRADE PROGRAM

The manufacturing-grade standards (USDA, 1996) cover the recommended requirements for both farms and plants, but with manufacturing-grade raw milk making up less than 3% of the total raw milk supply in the United States, the main focus of these requirements now is more toward manufacturing plants than farms. USDA has no legal responsibility for enforcement within a state of “Milk for Manufacturing Purposes and Its Production and Processing, Recommended Requirements” (USDA, 1996). It is the responsibility of each state to adopt and enforce these recommended requirements. The Agricultural Marketing Act of 1946 grants authority to USDA to act only in an advisory capacity to aid with interpretation and to promote the purpose and intent of the requirements as they have been published in the *Federal Register*. In addition, USDA continues to review and update these recommended requirements as is necessary to meet the needs of the states and their manufacturing-grade dairy industry.

In conjunction with this program, USDA also offers a voluntary inspection and grading service to manufacturing plants on a fee-for-service basis. It is the intent of this program to provide for consistently uniform high-quality dairy products, which can then carry an official government identification and grade (i.e., U.S. Grade AA, A, B, C, Extra or Standard). To obtain this approval, a plant must be surveyed under the inspection and grading services program as given in “General Specifications for Dairy Plants Approved for USDA Inspection and Grading Service” (USDA, 1995). This program provides for surveying the premises, equipment, facilities, operation methods, and raw milk quality for adequate compliance so a plant is eligible for inspection and grading services. A resident grading service can also be provided where a USDA Grader is assigned to an eligible plant or station on a continuous basis; otherwise a Grader is provided as needed by the plant. Failure by an approved plant to maintain these USDA product or process standards could lead to loss of their eligible status.

Manufacturing-grade dairy products purchased by the federal government for use, distribution, or storage under various government programs, with few exceptions, come from eligible plants covered by the USDA inspection and grading services program.

V. 3-A SANITARY STANDARDS

The objective of the 3-A Sanitary Standards Committees is to formulate standards and accepted practices for equipment and systems used to process milk, milk products, and other perishable foods. The International Association of Food Industry Suppliers (IAFIS) is the secretariat and the International Association for Food Protection (IAFP) through the Committee on Sanitary Procedures represents the regulatory stakeholders to the 3-A program (IAFIS, 1999). The dairy processors are represented by IDFA, ADPI, and the American Butter Institute.

There are more than 50 3-A Equipment Task Committees staffed by volunteers who support the activities of this program. Most dairy and food regulatory programs have incorporated the 3-A criteria as part of their regulations for both grade A and manufacturing-grade farms and plants. In addition, the 3-A Secretary and 3-A Steering Committee members provide the interface with two European and two international hygienic standards developers and also with the NSF International.

The 3-A Committees and their partners seek voluntary consensus to discover solutions to sanitary problems in construction and operation of dairy and food processing equipment. For over 70 years, processors have known they will be in compliance with applicable sanitary codes for equipment and processes that have received approval by the 3-A Sanitary Standards Committee. Equipment manufacturers also know that equipment fabricated in conformance to 3-A Sanitary Standards will receive universal acceptance from processors and regulators.

A. Preparation of a 3-A Sanitary Standard or Accepted Practice

A proposal request is sent to the 3-A Secretary's office and is then routed to the 3-A Steering Committee, who will assign the proposal to the appropriate Task Committees for study and preparation of the initial draft document. The 3-A Secretary incorporates the comments of all assigned committees and prepares a redraft. The redraft is distributed to the Task Committee to vote acceptance. The draft is then circulated to the technical committee and user group or other appropriate organizations until initial acceptance is achieved. The draft is then sent to the Committee on Sanitary Procedures/USPHS for review and acceptance. When all comments have been resolved at a plenary session of tripartite 3-A Committees, final adoption for signing and publication is based on the affirmation vote of all 3-A Sanitary Standards Committees. The 3-A Secretary then prepares the document for final review and validation. New standards and accepted practices or revisions and amendments to existing documents become effective 6 months after receiving the validating signatures.

3-A Sanitary Standards consist of six main parts; (a) scope of the Standard, (b) definition of the terms used in the Standard, (c) description of the permitted materials of the equipment, (d) details of the fabrication of the equipment, (e) appendix of references and special considerations, and (f) effective date.

Equipment manufacturers who wish to display the 3-A symbol on their equipment must apply to the 3-A Sanitary Standards Symbol Administrative Council. They must also submit the required supporting documents and self-declarative statement to receive approval. These authorizations to display the 3-A symbol are reviewed annually and can be amended as the manufacturer desires and can also be withdrawn for noncompliance by the Council.

Publication of the actions by the 3-A Committees takes place in *Dairy, Food and Environmental Sanitation* (IAFP) periodically during each year. Appropriate 3-A Committees review each standard at least once every 5 years. Sets of “3-A Sanitary Standards and Accepted Practices” are available through the Web site, www.3-A.org.

VI. OTHER REGULATORY PROGRAMS AFFECTING THE DAIRY INDUSTRY

As one of the most regulated industries, dairy farms and plants are affected to various degrees by several federal, state, and local regulatory agencies and programs other than the basic inspection-type programs covered in the earlier parts of this chapter. Although many of these do not directly impact on the microbial quality, they all in some way could impact on the overall quality, safety, and acceptance of the industry and its products. It would be virtually impossible to mention every one and discuss each in much detail, as they can vary from state to state or region to region. The following are a few which might be of considerable significance to the overall industry.

A. Food Labeling Laws

Although product labeling is covered under Section 4 and Appendix L of the PMO, it also references other federal documents, the “Federal Food, Drug, and Cosmetic Act” (FDCA) as amended, the “Nutrition Labeling and Education Act of 1990” (NLEA), and the *Code of Federal Regulations* (CFR) along with “Title 21” of the Code (21CFR).

1. Federal Food, Drug, and Cosmetic Act (FDCA)

The FDCA is the primary law under which the U.S. government acts to prevent adulteration and misbranding of the food supply. It contains general requirements

for foods, drugs, and cosmetics as well as sections that deal specifically with requirements for each. Section 401 provides the definitions and standards used in the PMO, but it also contains literally hundreds of other food product standards along with standards for most of the major dairy products. Other sections of the FDCA listed here also contain regulations of importance to the dairy industry: Sec. 402—Adulterated Food, Sec. 403—Misbranded Food, Sec. 408—Tolerances for Pesticides Chemicals, Sec. 409—Food Additives, Sec. 411—Vitamins and Minerals, Sec. 701—Regulations and Hearings, Sec. 702—Examinations and Investigations, Sec. 703—Records of Interstate Shipments, Sec. 704—Factory Inspections, Sec. 705—Publicity, Sec. 706—Listing and Certification of Color Additives, Sec. 707—Advertising of Certain Foods, and Sec. 801—Imports. With some part in each of these sections having an impact on the dairy industry, this document and the *Code of Federal Regulations* should be familiar to every dairy plant operator (Vetter, 1996).

2. Title 21 of the *Code of Federal Regulations* (21CFR)

The FDCA is the law that establishes the authority of FDA to regulate food products. 21CFR contains all rules promulgated and amended by the FDA for enforcement of laws pertaining to food products over which it has been given jurisdiction. These are contained in a nine-volume set of books, with the first three volumes dealing with food, the remaining six dealing with drugs, cosmetics, and medical devices. Updates are published every fall and include new and modified regulations that were finalized before April 1 of that year.

3. Fair Packaging and Labeling Act (FPLA) of 1966 and the Nutrition Labeling and Education Act (NLEA) of 1990

The purpose of the FPLA is to provide consumers with information on which to make purchasing decisions. This is accomplished by standardizing the specific size, type, and location of information on quantity and contents of a food package, which also better facilitates value comparisons. The details of where and how required information is presented on labels or in labeling are provided in regulations found in 21CFR.

NLEA of 1990 mandated nutritional labeling for FDA-regulated foods. Although not required by law, USDA promulgated nutrition labeling regulations for meat and poultry very similar to those for FDA-regulated food products. The detailed requirements for declaring nutritional information are found in 21CFR 101.9 for FDA-regulated food and 9CFR 317 for meat and 9CFR 381 for poultry. The total nutritional labeling regulation is very long and detailed but there is some specific information that must always be present on a regulated food label. This includes serving size, number of servings, declarations per serving of calories, and calories from fat. Also included are the content and percentage of daily

value for the following: total fat, saturated fat, cholesterol, sodium, total carbohydrate, dietary fiber, sugars, and protein. Included must also be percentage of daily value of vitamins A and C, calcium, and iron. Other values required by the regulation to be stated on a label will depend on additions and declarations made for a specific food product. Examples of standard formats for a nutritional facts panel along with other general information on proper product labeling can be found in the FDA publication “A Food Labeling Guide” (USPH, 1999). There are many other types and variations of these basic formats that are described in more detail in the complete NLEA regulations presented in 21CFR 101.9.

B. Food Product Recalls

The primary purpose of a food product recall is to protect consumers from a potential health hazard, severe economic deception, or other major violation of the FDCA. A withdrawal of product is classified as one of the following three general types:

1. “Stock Recovery,” the removal of a violative product that is still under the control of the manufacturer.
2. “Market Withdrawal,” the removal of a product that is an insignificant violation or may just be of a lesser quality than a manufacturer might desire.
3. “Recall,” the removal of violative product that represents a potential hazard to consumers or is a serious violation of the FDCA.

The FDA defines three classes of recalls in 21CFR 7.3 based on the seriousness of the violation of the food product to the FDCA:

- *Class I.* Reasonable probability that use of the product will cause serious adverse health consequences or death.
- *Class II.* It may cause temporary or medically reversible adverse health consequences but the probability of serious adverse health consequences is remote.
- *Class III.* It is not likely to cause adverse health consequences but may have a physical defect or some type of contamination of no real health significance.

Recalls, for the most part, are voluntary. FDA has no authority to order a recall, but it can threaten a seizure action if the company does not offer to recall the violative product. Although recalls are voluntary, in 21CFR 7 there is a set of guidelines that companies have found to be desirable and beneficial to follow when recalling a product. Notifying FDA of a recall is not required but is a good idea, as the agency will be of great assistance in establishing the class and effective recall plan. The agency can also be of assistance in determining the cause

and in helping to correct the problem. FDA will also notify the appropriate state agency to help in development of a basic plan of action and to oversee the effectiveness of the recall. Should a company or state agency not act appropriately in carrying out the recall or in correcting the cause, FDA is prepared to step in and take the necessary enforcement action to protect the public health. When a recall has effectively removed all products in question, FDA will then issue a written notification that the recall is terminated.

It is important that a company be prepared to handle a recall by having a written plan to conduct the recall, a coding system to identify all products produced, and distribution records for all products.

C. Other Federal Agencies Impacting on the Dairy Industry

Other than those mentioned earlier in this chapter, there are the following, which depending on the production facility, processing plant, or product, could have some regulatory impact:

- Environmental Protection Agency (EPA)
- Occupational Safety and Health Administration (OSHA)
- Federal Trade Commission (FTC)
- U.S. Department of Commerce (USDC)
- Bureau of Alcohol, Tobacco, and Firearms (ATF)
- U.S. Department of Labor (USDL)

Of those listed above, EPA and OSHA are the two most likely to have an impact on the entire industry. As environmental concerns continue to rise, such as soil and water pollution, the EPA will be monitoring both farms and plants very closely to see that any expansions or changes will not negatively impact the environment. Although this can be an economic burden to the industry in some instances, it can also help in protection and safety of products produced.

A similar point can be made for OSHA, as this agency not only is interested in protecting the safety of workers and the workplace but also in protecting products from potential contamination.

In addition to these federal agencies, there may also be similar state and local agencies that will not only be enforcing federal laws and regulations but also their own additions and variations, especially in environmental protection. Dairy producers as well as processors need to be aware of the various laws and regulations that so carefully control what they do and how they do it even though at times this can seem a bit overwhelming.

The U.S. dairy industry, through all of its regulatory concerns and frustrations, continues to demonstrate its ability to produce and process the safest and most wholesome dairy products possible.

VII. FUTURE OF DAIRY REGULATION

The issue of food safety will remain the number one concern for dairy regulatory control agencies as well as for the industry itself. It is, for example, becoming more important to the industry to determine what microorganisms are present and their likely origin than just to determine the total number present, as in current regulations. Therefore development of a strong HACCP-based program from the farm to the consumer will be important in dealing with this type of need for new and different information. This in turn will impact on the future of dairy regulations, meaning more involvement of the dairy industry in its own regulation, a definite change from the current system. Both state and federal regulatory programs will begin to change from the physical type inspection to more of an auditing type of oversight to verify that a product produced and processed can be documented as "safe." This type of "risk"-based system will provide a means for the industry to document to the oversight agencies, its ability to detect problems related to food safety, and make corrections before distribution and sale of its products. Although much of the food industry has already moved in the direction of HACCP, it will be a bigger step for regulatory agencies to adjust to this change.

With the expanding significance of global trade, the need for a more universal food code will be paramount in the near future. The Food and Agriculture Organization (FAO) and the World Health Organization (WHO) have set up a Codex Alimentarius Commission and Subsidiary Bodies that presents a unique opportunity for all countries to join the international community in formulating food standards and working toward their global implementation. Development of the dairy portion of the Codex has been in process for some time and will be of significance in governing the hygienic processing practices and recommendations relating to compliance with dairy product standards that can be adopted globally. The FDA, USDA, and other government and industry representatives have been participating on Codex committees and as members of the Commission to represent the interests of the United States. The future of international trade will be dependent on the successful completion of this effort, as will protection of public health and fair practices in the future of global food trade.

Movement to such a system should also aid in consolidation of many of the regulatory activities by multiple agencies, as everyone's ultimate goal is to be able to document the quality and safety of all food products. With HACCP-based industry and regulatory programs that foster cooperation between the industry and its oversight agencies and development of an international food code, there should continue to be a strengthening of consumer confidence in dairy products, as well as all food products no matter where they are produced or processed.

Dairy regulatory programs of the future will likely continue to develop along the lines of cooperation and consolidation to promote the continued emphasis toward a global assurance of food safety.

REFERENCES

- Boosinger J. The History and Accomplishments of the National Conference on Interstate Milk Shipments. Frankfort, KY: National Conference on Interstate Milk Shipments, 1983.
- Cunniff P, ed. Official Methods of Analysis of AOAC International. 16th ed. 4th rev. Gaithersburg, MD: Association of Analytical Chemists, 1998.
- International Association for Food Protection. Dairy, Food, and Environmental Sanitation. Des Moines, IA: IAFP, monthly publication.
- International Association of Food Industry Suppliers, The 3-A Story. McLean, VA: International Association of Food Industry Suppliers, 1999.
- Marshall RT, ed. Standard Methods for the Examination of Dairy Products. 16th ed. Washington, DC: American Public Health Association, 1992.
- Sinclair U. The Jungle. New York, NY: Bantam Books, 1981.
- U.S. Department of Agriculture, Agricultural Marketing Service. Milk for Manufacturing Purposes and its Production and Processing, Recommended Requirements. Washington, DC: US Government Printing Office, 1996.
- U.S. Department of Agriculture, Agricultural Marketing Service. General Specifications for Dairy Plants Approved for USDA Inspection and Grading Service. Washington, DC: US Government Printing Office, 1995.
- U.S. Department of Health and Human Services, Food and Drug Administration. Code of Federal Regulations, Title 21. Washington, DC: US Government Printing Office, 1999.
- U.S. Public Health Service. Evaluation of Milk Laboratories, 1995 revision. Washington, DC: U.S. Department of Health and Human Services, Public Health Service, Food and Drug Administration, 1995.
- U.S. Public Health Service. A Food Labeling Guide, 1999 revision. Washington, DC: US Department of Health and Human Services, Public Health Service, Food and Drug Administration, 1999.
- U.S. Public Health Service. Grade A Condensed and Dry Milk Ordinance, 1995 revision. Washington, DC: US Department of Health and Human Services, Public Health Service, Food and Drug Administration, 1995.
- U.S. Public Health Service. Grade A Pasteurized Milk Ordinance, Publication No. 229, 1999 revision. Washington, DC: US Department of Health and Human Services, Public Health Service, Food and Drug Administration, 1999.
- U.S. Public Health Service. A Brief History of U.S. Food and Cosmetic Acts and Regulations Administered by FDA. Washington, DC: US Department of Health and Human Services, Public Health Service, Food and Drug Administration, Center for Food Safety and Applied Nutrition, 1987.
- U.S. Public Health Service. IMS List, Sanitation Compliance and Enforcement Ratings of Interstate Milk Shippers, Quarterly publication. Washington, DC: US Department of Health and Human Services, Public Health Service, Food and Drug Administration, 1999.
- U.S. Public Health Service. Methods for Making Sanitation Ratings of Milk Shippers,

- 1999 revision. Washington, DC: US Department of Health and Human Services, Public Health Service, Food and Drug Administration, 1999.
- U.S. Public Health Service. Milk Pasteurization Controls and Tests, 4th ed. Washington, DC: US Department of Public Health and Human Services, Public Health Service, Food and Drug Administration, State Training Branch, 1993.
- U.S. Public Health Service. Procedures Governing the Cooperative State-Public Health Service/Food and Drug Administration Program for Certification of Interstate Milk Shippers, 1999 revision. Washington, DC: US Department of Health and Human Services, Public Health Service, Food and Drug Administration, 1999.
- U.S. Public Health Service. Standards for the Fabrication of Single Service Containers and Closures, 1999 revision. Washington, DC: US Department of Health and Human Services, Public Health Service, Food and Drug Administration, 1999.
- Vetter JL, Food Laws and Regulations, Manhattan, KS: American Institute of Baking, 1996.

17

Testing of Milk and Milk Products

Charles H. White

*Mississippi State University
Mississippi State, Mississippi*

I. INTRODUCTION

Microbiological testing in the dairy plant is critical to ensure that raw milk, other ingredients, and finished products are of high quality. Such testing also serves to verify the adequacy of Hazard Analysis Critical Control Point (HACCP) procedures. Testing for pathogens is normally not done in the dairy plant, but samples are sent to a laboratory located far enough from the plant to preclude introduction of unwanted microorganisms through manipulations in the laboratory (see Chaps. 13, 15, and 16).

This chapter lists the chemical, microbiological, and physical tests that might be done on incoming raw milk and considers the specific microbial aspects of raw milk quality. Also discussed are testing of raw milk and raw ingredients, line sampling, and tests for predicting shelf life of products, testing of various types of dairy products, and the future of testing of milk and milk products.

II. RAW MILK QUALITY

A. General

There are many ways to measure the quality of raw milk. Some of the tests that are done by dairy processing plants either before or after unloading a tanker of milk include the following:

1. Standard plate count (SPC)
2. Direct microscopic count (DMC)

3. Freezing point determination (cryoscope)
4. Presence of inhibitory substances (antibiotic screening test)
5. Sensory evaluation
6. Preliminary incubation (PI-SPC)
7. Direct microscopic somatic cell count (DMSCC)
8. Acid degree value (ADV)
9. Laboratory pasteurization count (LPC)
10. Thermoduric spore count
11. Fat content
12. Total solids content (can also include protein content)
13. Sediment test
14. Presence of aflatoxins
15. Temperature

In addition, the weight (total quantity of milk) of the tanker is obtained to ensure proper payment to dairy farmers and to ensure that the processing plant is receiving all the milk for which it is making payment. However, compositional and chemical quality factors are always important.

Some of the aforementioned tests should be done before unloading the tanker. There is a definite time restraint involved with receiving and unloading a tank load of milk; however, the processor, not the producer, is the customer and should take a reasonable amount of time to obtain satisfactory results from the tests selected. It is recommended that the following tests be done on each tanker load of raw milk before unloading: DMC (until a more definitive test can be done in the same amount of time—bioluminescence may be this test), antibiotic screening test, cryoscope for added water, temperature, and sensory evaluation, which should involve checking the odor of the tanker followed by heating the milk and rapid cooling to taste the sample.

Compositional tests (e.g., tests for fat and total solids) should be done on every tanker of milk, although not necessarily before unloading. If the tanker load of milk is from independent producers, tests for abnormal milk, such as DMSCC, are also needed. Most other tests can be used as troubleshooting tests if there is a shelf life problem.

Some tests are good for troubleshooting purposes. If shelf life problems are of concern, the first step would be to verify the quality of the raw milk. An example would be to use the laboratory pasteurization count (LPC) as a way of determining whether or not there are a significant number of thermoduric bacteria present. As a general rule, if the LPC exceeds 500 cfu/mL, a major thermoduric problem exists in the raw milk supply.

Another problem which still occurs is that of “ropy” milk. *Alcaligenes viscolactis* is considered to be the primary cause of this defect. Other bacteria can cause varying degrees of ropiness in milk. This particular defect is extremely unpleasant to the consumer and must be detected and prevented by the processor. The major

cause of ropiness is improperly cleaned equipment at the dairy farm. This can either be in the milking parlor or in the bulk storage tank. Most of the bacteria causing ropiness are gram negative and are destroyed by pasteurization; however, just as we have concerns with cross contamination (from raw to pasteurized/packaging area) with *Listeria monocytogenes* and other potential milkborne pathogens, if *Alcaligenes* gets into the plant, a major problem can result.

Although the flavor of ropy milk normally is not distinguishable from normal milk, the long threads, or rope, can be pronounced and unforgettable. Johnson (Johnson P., Randolph Assoc, Apr. 2000) described a procedure for testing for ropy milk (if ropiness is a problem, raw milk from every raw tanker should be tested).

1. Incubate sample at 15.5–18.3°C (60–65°F) for 12–24 h. Temperatures as high as 21°C (70°F) may be used, but interference from acid-producing bacteria may be experienced.

2. Following incubation, insert a needle (match stick, small-bore pipette, etc., will do) at several locations on the surface, and slowly withdraw it.

3. Any strings 1/4-inch or longer would be considered to be a positive test for ropiness (Johnson P., Randolph Assoc, 2000).

The number of dairy farms has been decreasing steadily to the point where most of the dairy farmers in business (just as with the processors) take their jobs very seriously. As a result, the quality of raw milk is very good. This is not to imply that all raw milk is of excellent quality and cannot be improved. In 1982, Zall et al. summarized results of the SPC, psychrotrophic bacteria count (PBC), and ADV tests of raw milk held at 6.7°C for 0, 3, or 6 days. A summary of their results follows:

Test (mean)	Day of storage at 6.7°C ^a		
	0	3	6
SPC	4.92 ^b	7.36	8.39
PBC	4.45	6.77	8.46
ADV	0.80	1.38	4.89

^a Summarized from Zall et al. (1982).

^b Counts expressed in log numbers.

The above data indicate the practical importance of the legal limit of holding raw milk no more than 72 h. At 3 days' storage, the PBC had increased to a level which produces significant amounts of heat-stable proteases and lipases. This occurrence can be especially damaging to cheese processors. In addition, the ADV had increased to a point at which rancidity could be detected. This rancid flavor cannot be eliminated; rather the intensity continues to increase. Attempts to camouflage this off-flavor are futile; if the milk with a high ADV was to be added to chocolate ice cream mix, the resulting chocolate ice cream would have a rancid flavor.



Figure 1 QA technician determining estimate of somatic cell numbers in raw milk using the latest instrument. (Photograph courtesy of Mayfield Dairies and Dean Foods Company, Athens, TN.)

There was a substantial increase in bacterial numbers regardless of type whether mesophilic or psychrotrophic. The legal SPC standard for raw milk is 100,000 cfu/mL (individual producer) or 300,000 cfu/mL (commingled) milk. Individual raw milk can consistently be produced with less than 10,000 cfu/mL. Counts in tanker loads of milk vary from less than 10,000 to greater than 1,000,000 cfu/mL. The count in most raw milk (tanker loads) currently being received at fluid milk plants in the United States ranges from 30,000 to 70,000 cfu/mL.

The changes in the standard for the DMSCC from 1,000,000 to 750,000 cells/mL indicate an improvement in raw milk quality. Although there is no rule about increased bacterial numbers with increased somatic cell counts, this correlation does appear to exist. Within the next few years, it is likely that this standard will be reduced even further; for example, to 500,000/mL. (Figs. 1–6.)

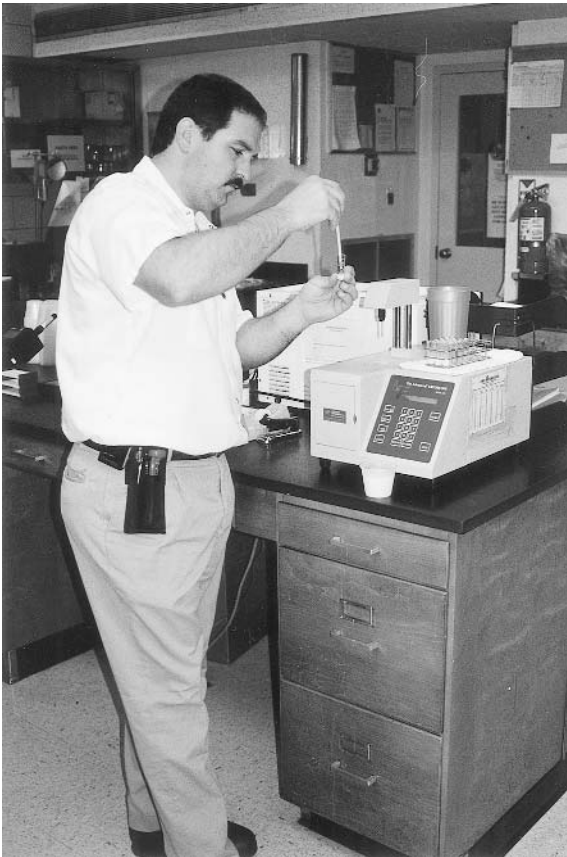

Figure 2 QA technician measuring freezing point of milk to check for added water. (Photograph courtesy of Mayfield Dairies and Dean Foods Company, Athens, TN.)

B. Raw Milk Microflora (see also Chapter 2)

According to one recent study (Celestino et al., 1996), gram-positive bacteria are present in raw milk in much smaller numbers than gram-negative species. These workers reported on numbers of *Pseudomonas* as well as other gram-negative and gram-positive bacteria in both farm bulk tanks and in creamery and plant silos. In farm bulk tanks, regardless of temperature, pseudomonads represented more than 80% of all bacterial isolates. The gram-positive bacteria in milk at the farm bulk tank in this study represented no more than 1% of the total. When the milk was commingled in creamery silos, the pseudomonads represented approxi-



Figure 3 QA technician measuring fat content of raw milk using Babcock method—note safety equipment required (apron, gloves, goggles). (Photograph courtesy of Mayfield Dairies and Dean Foods Company, Athens, TN.)

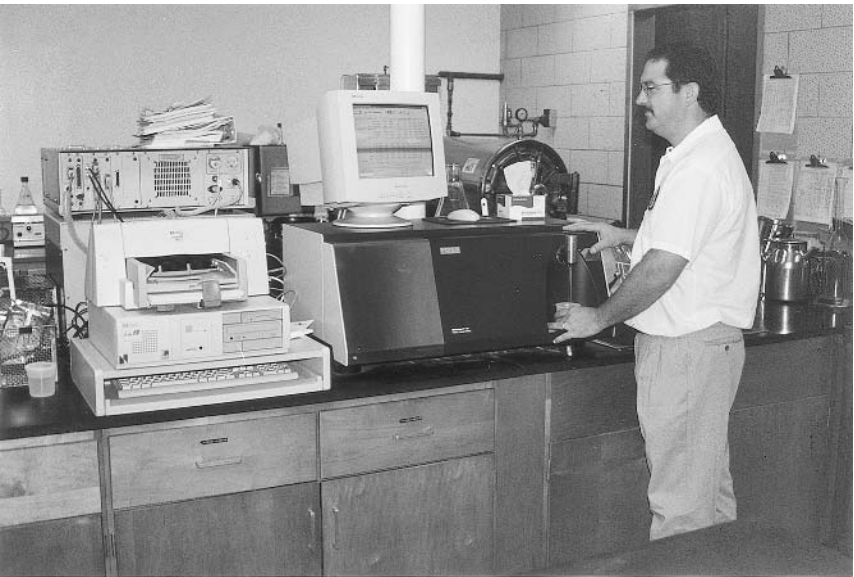

Figure 4 Automated method of fat and total solids measurement for milk and milk products. (Photograph courtesy of Mayfield Dairies and Dean Foods Company, Athens, TN.)



Figure 5 QA/receiving technician screens incoming raw milk for antibiotics/inhibitory substances. (Photograph courtesy of Mayfield Dairies and Dean Foods Company, Athens, TN.)

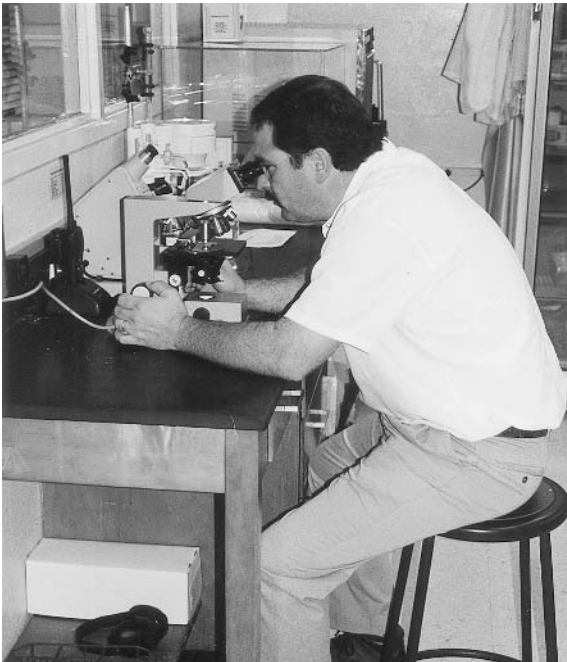

Figure 6 QA technician doing DMC on incoming raw milk. (Photograph courtesy of Mayfield Dairies and Dean Foods Company, Athens, TN.)

mately 70% of the microflora. The gram-positive bacteria increased to 9.0% to 14.1%, depending on temperature. Members of the family Enterobacteriaceae represented up to 15% of the total microflora of milk in the creamery silos.

Celestino et al. (1996) made a most significant conclusion: "As the quality of pasteurized milk improves because of reduction in levels of postpasteurization contamination, the presence of a heat-resistant psychrotrophic bacteria in the milk supply will assume greater importance." Of these, spore-forming microorganisms such as *Bacillus* are the most important. Work in Griffiths' laboratory was reported by these researchers, which indicated that higher heat treatments applied to the milk (70°C rather than 60°C) tended to decrease spore counts, presumably because of the activation of spores, which could subsequently germinate and divide. Using this as evidence, they cautioned that an increase in pasteurization temperature does not necessarily result in an increased shelf life. This has been the tendency of many processors over the past 15 years (since *Listeria* and *Salmonella* became known to the dairy industry).

C. Spore Formers

It might be concluded that the higher the quality of raw milk, the higher will be the incidence of gram-positive spore-forming bacteria. According to Martin (1974), *Bacillus* species account for 95% of the total spore-forming bacteria in milk, with *Clostridium* species comprising the remaining 5%. He indicated that, in the United States, 43% of *Bacillus* organisms are *B. licheniformis* and 37% are *B. cereus*; however, in other countries, *B. cereus* is predominant. The data in Table 1 (Martin, 1981) indicate that spore-forming bacteria are expected to be present in almost all raw milk supplies. As the dairy processing industry becomes more involved with extended shelf life (ESL) products, the problem with spore-forming bacilli will probably increase. Thus, an aerobic spore count (80°C for 12 min followed by rapid cooling and plating on plate count agar (PCA) with incubation of plates at 32°C for 48 hours) will become a vital microbiological test for raw milk.

D. Psychrotrophic Bacteria

A simple definition of psychrotrophic bacteria is those bacteria that can grow fairly rapidly at refrigeration temperatures. A psychrotroph is unlike a true psychrophile, which is a bacterium whose optimal growth temperature is 10°C or less. There are not many psychrophiles encountered in the dairy industry. In raw milk, the larger the percentage of psychrotrophic bacteria, the greater the number of problems encountered by the dairy processor using such raw milk. A typical psychrotroph (e.g., a pseudomonad) could conservatively have a generation time (the length of time a bacterial population requires to double in numbers) of 9 h

Table 1 Standard Plate Counts and Aerobic Spore Counts of Raw Milk^a

Class	SPC range (per mL)	No. of samples analyzed	Average SPC (per mL)	Mesophilic spore counts	Thermophilic spore counts	
				Average (per mL)	No. of positive samples	Average (per mL)
I	<50,000	19	32,000	400	16	46
II	≥50,000 to <200,000	36	98,000	400	35	45
III	≥200,000 to <1,000,000	48	580,000	710	40	55
IV	≥1,000,000 to <5,000,000	73	2,300,000	760	60	41

^a Spore counts were determined after heating milk at 80°C for 10 min. Mesophilic counts were determined by a pour plate procedure; thermophilic counts by a most probable number dilution tube technique.

Source: 16th International Dairy Congress Proceedings. 1962, pp. 295–304, as reported by Martin (1981).

or less at 7°C. Thus, if a load of milk contains 100,000 cfu/mL with 70% of the microflora being psychrotrophic, then, within 36 h at 7°C, the counts could exceed 1,000,000 cfu/mL. This large number can produce large amounts of proteases and lipases, which can cause serious quality problems for processed products.

In a dated but excellent review of psychrophilic bacteria, Witter (1961) indicated that the choice of the word *psychrophile* was unfortunate, because the root name implied “cold-loving.” Many people still use the term *psychrophile* when *psychrotroph* is what is intended. The key to recognizing the difference is in the optimal growth temperature range. Psychrotrophs have an optimal growth temperature in the range of 21°C to 28°C, whereas, as previously discussed, a true psychrophile has a much lower optimal growth temperature. Most of the bacteria that cause problems to the dairy processor are of the psychrotrophic type, which means that, as the temperature is allowed to increase, the generation time is reduced and more psychrotrophs are produced (see Chap. 2).

Witter (1961) indicated that the natural sources of the predominant psychrophilic (psychrotrophic) bacteria are water and soil. Because water and soil are both present in abundance on dairy farms, it is not surprising to find that these psychrotrophs work their way into the milk supply. Hence, it is incumbent upon all segments of the dairy industry to work at keeping equipment clean (as a means of reducing the number of psychrotrophs gaining entrance into the milk) and temperatures as low as possible to retard growth of the psychrotrophs that do get into milk. Witter (1961) also indicated that, at the lower temperatures, from 7°C to 0°C (their minimum growth temperature), the decrease in growth rate was dramatic. Thus, even though the legal limit for holding milk is 7°C, the closer to 0°C that the milk can be held, the higher will be its quality from the standpoint of growth of psychrotrophic bacteria.

For the reasons just outlined, there is a need to monitor the psychrotrophic population of incoming raw milk. Most measurements are by SPC or DMC, both of which measure total bacterial numbers; those capable of growth at 32°C are measured by the SPC. The PI-SPC (milk is held at 13°C for 18 h before it is plated) is one way of estimating the psychrotrophic nature of the microflora. The milk could be incubated for 24–48 h and then plated (SPC). Regardless, it is very important for the dairy processor to have an idea of the psychrotrophic quality of the raw milk, particularly in cheese making. White and Marshall (1973) found that flavor scores were significantly lower for Cheddar cheese made from milk containing a protease from a pseudomonad when compared with control cheese. Witter (1961) indicated that pseudomonads (the primary psychrotrophic/psychrophilic group) possess certain characteristics that make them important to milk and other foods. Some of these characteristics are (a) ability to use a wide variety of carbon compounds for energy and inability to use most carbohydrates, (b) ability to produce a variety of products that affect flavor, (c) ability to use

simple nitrogenous foods, (d) ability to synthesize their own growth factors or vitamins, and (e) proteolytic and lipolytic activity.

Because a high psychrotrophic load can adversely affect the quality of various dairy products, especially cheese and extended-shelf life products, it behooves the processor to routinely monitor the psychrotrophic population of incoming loads of raw milk.

E. Proteases

Because psychrotrophic bacteria can produce both lipases and proteases, it is important to understand the activity of the various enzymes that can be liberated into the milk. Many of the proteases tend to be extremely heat stable, which can result in defects during extended refrigerated storage of milk. Adams et al. (1975) studied heat-resistant proteases produced in milk by psychrotrophic bacteria. They found all of the psychrotrophs obtained from raw milk produced proteases that survived at 149°C for 10 s. They reported that 70–90% of raw milk samples contained psychrotrophs capable of producing these heat-resistant proteases. White and Marshall (1973) reported on a heat-stable protease that retained 71% of its original activity after being heated at 71.4°C for 60 min. Also, the enzyme hydrolyzed milk protein at 4°C.

In another study, Adams et al. (1976) isolated 10 gram-negative psychrotrophs from raw milk that readily attacked raw milk proteins. They reported that κ - and β -casein were most susceptible to attack by these psychrotrophs, although they indicated that some of the isolates also attacked whey proteins. They further stated that the proteolysis did not require large populations of psychrotrophs; 10–20% decrease in κ -casein during 2 days at 5°C accompanied growth of one isolate to a population of only 10,000/mL. Guinot-Thomas et al. (1995) studied proteolysis of raw milk during storage at 4°C. They specifically looked at the effect of plasmin and microbial proteinases. Their study demonstrated the greater importance of microbial proteinases than of plasmin at this temperature. Also, they reported that hydrolysis of caseins by microbial proteinases affected mainly the κ -casein fraction, colloidal calcium, and consequently casein micelles. They concluded that this effect will be noted even more as the number of psychrotrophs becomes higher. Rollema et al. (1989) compared different methods for detecting these bacterial proteolytic enzymes in milk. This was a study in which two fluorescamine assays, a trinitrobenzene sulfonic acid (TNBS) assay, an azocoll assay, a hide powder azure (HPA) assay, and an enzyme-linked immunosorbent assay (ELISA) were tested for their effectiveness in detection of proteolytic enzymes from six strains of psychrotrophic bacteria. These workers concluded that the TCA-soluble tyrosine and the thin-layer caseinate diffusion assay are too insensitive to be used for quality control of dairy products. They stressed that a good correlation between the proteolytic activity determined with an assay and the

keeping quality of the product is a prerequisite for applicability of the assay for quality control of dairy products. Their preliminary study indicated that this requirement could be reasonably satisfied by the fluorescamine, TNBS, and azo-coll assays.

III. MICROBIOLOGICAL TESTING OF RAW MILK AND RAW INGREDIENTS

A. Raw Milk (see also Chap. 2)

Because the microbiological quality of raw milk does not improve during storage, it is critical that the processor evaluate the raw milk to ensure that only high-quality milk is accepted. With regard to microorganisms, the following information must be known:

1. *Total count or aerobic plate count.* Classically, this is determined by the use of the SPC procedure. In legal matters concerning acceptability of an incoming tanker of milk or milk from an individual producer, the SPC is the standard to which other screening tests are compared.

2. *DMC.* In this procedure, as outlined in *Standard Methods for the Examination of Dairy Products* (Marshall, 1992), results can be obtained within 15 min by a trained laboratory technician. Dead as well as living cells are counted, so the DMC should result in a slightly higher count than the SPC. The big advantage is that results may be obtained before milk is unloaded into the processing facility. This allows for much better microbiological control over incoming raw fluid dairy products. The problem that many people encounter when initially using the DMC is that they try to be too "fine" with the results; for example, they may try to distinguish between a count of 40,000 and 45,000 instead of just using the DMC to detect the very high count loads. The DMC was not designed to reflect minor differences in numbers of bacteria; rather, in this instance, the test is strictly used to determine whether a tanker load of milk, cream, or condensed skim milk is of sufficiently high microbiological quality to be unloaded into the plant.

3. *Psychrotrophic estimates.* There are many types of bacteria in raw milk. It is critical to know what percentage of the population is of a psychrotrophic nature. The standard psychrotrophic bacteria count (PBC) requires incubation of the plate for 10 days at 7°C (Marshall, 1992). This length of time is commercially unacceptable to determine the psychrotrophic population of raw milk. Various elevated incubation temperatures (e.g., incubation of plates at 18°C or 21°C using PCA) give an estimate of the psychrotrophic population. Incubating raw milk (cream or condensed skim milk) for 24–36 h at 7°C followed by SPC incubation also gives some idea as to the number of psychrotrophs present.

4. *PI-SPC*. Johns (1960) first described this method for evaluating raw milk quality. His method involved incubating raw milk at 12.8°C (55°F) for 18 h. Following this preliminary incubation, a conventional plate count was done. This method was thought to identify milk that had been subjected to less than desirable sanitary conditions at the farm level. Maxcy and Liewen (1989) found that preliminary incubation at the recommended temperature (12.8°C) did not have a selective effect for specific groups of microorganisms. Thus, apparently, the PI-SPC procedure is not extremely reliable as a means of evaluating raw milk quality. Certainly, the time involved for this procedure minimizes its effectiveness in screening raw milk supplies.

5. *Coliforms*. According to *Standard Methods for the Examination of Dairy Products* (Marshall, 1992), coliforms are a group of bacteria that comprise all aerobic and facultatively anaerobic, gram-negative, non-spore-forming rods able to ferment lactose and produce acid and gas at 32°C or 35°C within 48 h. Typically, coliforms are used as a measure of sanitary conditions in the processing and packaging of pasteurized dairy products. Coliforms are destroyed by pasteurization; hence, any coliforms found in the pasteurized product indicate postpasteurization contamination.

Coliforms may also be of value in checking raw milk. There is no legal standard for the numbers of coliforms that might be present in raw dairy ingredients. It is suggested that a value of 100 coliforms per milliliter be used as an initial screening tool for raw milk. The procedure used would be the same as that outlined in *Standard Methods* (Marshall, 1992). As with pasteurized milk, coliforms are “indicator organisms.” This simply means that if coliforms are present, conditions may be suitable for the presence of enteric pathogens, such as *Salmonella*.

6. *Adenosine triphosphate bioluminescence assays*. In an excellent overview of how ATP bioluminescence can be used in the food industry, Griffiths (1996) agrees with other researchers (Bautista et al., 1992; Griffiths et al., 1991; Reybroeck and Schram, 1995; Sutherland et al., 1994) that these assays may be used successfully for determination of microbial loads in raw milk within 10 min. Griffiths (1996) described that the milk is incubated in the presence of a somatic cell-lysing agent and then filtered through a bacteria-retaining membrane. The microorganisms retained on the filter are then lysed with the lysate being assayed for ATP activity. He stressed that microbial populations down to 10⁴ cfu/mL can be detected with a greater precision than with the SPC.

Griffiths (1996) described the work of Pahuski et al. (1991), which involved a “concentrating” reagent, Enliten, that clarifies milk and allows removal of microorganisms by centrifugation. These workers indicated that a combination of this treatment along with an ATP assay enabled detection of microbial levels down to 2 × 10⁴ cfu/mL within 6–7 min.

B. Dairy Ingredients

Many dairy ingredients other than raw milk are received by dairy and food processing plants. Some of these products include nonfat dry milk, whey powder, whey protein concentrates and isolates, condensed skim milk, condensed whole milk, sweetened condensed skim milk, and whole milk, cream, and butter. These ingredients must also be tested to ensure their overall quality and that they meet established microbiological criteria. The SPC and the coliform count using violet red bile agar (VRBA) are outlined in *Standard Methods for the Examination of Dairy Products* (Marshall, 1992). This compilation of accepted methods is descriptive with regard to sampling and the quantity of ingredient required for appropriate analysis. Representative samples of each incoming batch should be tested to ensure acceptability. When receiving dried products, a statistically valid number of samples should be obtained. Various sampling procedures have been used by companies, with the military standard MIL-STD-105D being a well-accepted method for determining the number of samples to be taken. A rough approximation for sampling is based on the following formula (does not take into account degree of severity).

$$\text{Number of samples} = \frac{\sqrt{\text{batch size}}}{10}$$

The number of samples should be randomly drawn to ensure representative sampling and testing of the entire batch.

C. Nondairy Ingredients

Many ingredients other than dairy products are brought into dairy processing plants. Examples of such products include fruits, nuts, stabilizers, emulsifiers, fat replacers, sucrose and other sweeteners, and spices. The key to ensuring the quality of all ingredients, especially nondairy ingredients, lies with the requirement of a product specification sheet. Each supplier that provides products to a dairy processing plant should provide an individual product specification sheet for each item sold to that company. The specification sheet, which should be updated annually, should contain a description of the product as well as guidelines that the product must meet. Microbiological testing should be outlined on the product specification sheet. This includes the type of tests to be done and either the method outlined or a reference to the procedure to be followed. The specification should ensure that ingredients have been tested for specified pathogens and are known to be “pathogen free.” Again, the SPC and the coliform count are commonly used procedures in evaluating the quality of many of these ingredients. Counts are typically related to the grade of product being received. Samples must

be obtained as soon as the products arrive so accurate and prompt microbial analysis can be accomplished.

The following is an outline of microbiological testing that should be done on incoming raw dairy ingredients and nondairy ingredients, as recommended by myself and H. E. Randolph (personal communication, 1996).

Microbiological testing of raw milk

Test	Suggested standard (cfu/mL)
1. Direct microscope count—every tanker (before unloading)	200,000
2. Coliform (violet red bile agar)—every tanker (backtrack to individual producer if necessary)	100
3. Standard plate count (PCA)—silos daily	100,000
4. PI-SPC (18 h at 12.8°C)—silos daily (backtrack if necessary)	300,000

The PPC or the PI-SPC is especially critical for cheese operations, because the presence of proteases from psychrotrophic bacteria can adversely affect yield as well as quality of these concentrated products.

IV. LINE SAMPLING/TESTING

One of the most important aspects of microbiological testing of milk and milk products is line sampling. If only the finished product is tested, then it is only known whether the finished product is “good” or “bad”; however, if the shelf life of the product is less than desirable, it is not known where the postpasteurization contamination occurred. To gain such information is the purpose of line sampling. In a fluid milk operation, line samples should be obtained at the following locations:

1. At or immediately after the high-temperature, short-time pasteurizer. This is done to ensure that neither the regenerative plates nor cooling plates have pinhole leaks.
2. Preceding pasteurized milk storage tanks. This verifies the cleanliness of the pasteurized milk lines leading from the pasteurizer to storage tanks.
3. Line sample leading from the pasteurized milk storage tanks. This is done to ensure cleanliness of the storage tank itself.
4. Immediately preceding entry of the milk into the separate fillers.

By checking each of these locations, postpasteurization contamination can be pinpointed.

Because most dairy processing plants have welded pipelines and do not disassemble all of their piping, the method for obtaining aseptic line samples becomes critical. One very efficient way of obtaining good samples is by use of the QMI Aseptic Sampler (Food and Dairy Quality Management, Inc., QMI, St. Paul, MN). The aseptic samplers are inserted into stainless steel elbows for ease of sample extraction. Even though virtually any size sample can be taken, a minimum of 50 mL and preferably 60 mL should be used. There is a greater chance of detecting microorganisms that could be detrimental to product shelf life from a larger sample.

Regular grommets can also be inserted and then a syringe and needle can be used to extract samples of similar size. Samples in the syringes can be used for any number of microbiological evaluations. The primary bacterial types of concern in these samples are coliforms and psychrotrophic bacteria. To enhance enumeration of psychrotrophic bacteria, a step commonly used is to incubate the sample (in the syringe) at 21°C for 18 h. Following this preincubation, the sample can either be plated for SPC or for coliforms (VRBA). The preliminary incubation is not absolutely necessary, but it does enhance enumeration of any psychrotrophs or heat-injured coliforms that might be present. A SPC on the fresh milk is virtually meaningless. Thus, the different options to consider with regard to microbiological evaluation of line samples are: (a) fresh milk coliform count—VRBA, (b) PI-VRBA, (c) PI-SPC, and (d) PI plus any other selective media designed to enumerate psychrotrophic bacteria, such as PI + CVT (crystal violet tetrazolium agar).

After counts are obtained (counts should be viewed as the same as for any finished fluid product), gram stains of preparations from colonies on plates can be made to determine whether the microorganisms appearing in “spoiled” products are similar to those observed in line sampling. This can be a direct indication of the presence of bacteria that are reducing shelf life.

V. SHELF LIFE—PREDICTING TESTS FOR FLUID MILK—TYPE PRODUCTS AND ESTIMATION OF ACTUAL PRODUCT SHELF LIFE

The term *shelf life* can be used interchangeably with the term *keeping quality*, which is defined as the time a product remains acceptable in flavor after packaging. The question then becomes, What is an acceptable shelf life for fluid milk products. Before answering this question, the temperature at which the product is held when shelf life testing is done must be specified. The temperature most commonly used is 7°C (45°F), which is chosen because it approximates the tem-

perature of dairy cases in supermarkets and the home refrigerator (Bishop and White, 1985; White, 1991). Also, as has previously been pointed out (Bishop and White, 1985), in all shelf life prediction studies, the “potential” shelf life is actually what is being measured, because the experimental sample stored in a cooler in the laboratory is not subjected to the rigors of distribution and transportation.

Almost all tests that are designed to predict the shelf life of dairy products are based on detection of gram-negative psychrotrophic bacteria (especially the pseudomonads). These microorganisms cause most shelf life problems, especially in fluid milk and cottage cheese. Regardless of the method, the key (White, 1991) to predicting the shelf life of milk and milk products is that the method must be rapid—reliable and meaningful results must be obtained within 72 h and ideally within 24 h.

In addition, results of tests to predict shelf life must be compared or correlated with the actual product shelf life. Thus, to determine whether or not a particular test to predict shelf life is effective, the actual product shelf life must be assessed. The actual product shelf life is determined by holding the samples at 7°C and testing them every day until an off-flavor develops. The shelf life is then estimated as the day the off-flavor developed minus 1. To minimize the number of times the container is opened and closed, the products do not need to be tasted until after day 10 (assuming that the product had a shelf life of 10 days or more). It is important in determining basic product shelf life to use the same container, because each filler head (on a gallon filler) can yield significantly different results. In selecting samples from a filler, it is good to rotate the samples obtained so that, over a given period, all filler heads can be sampled.

Correlation between the results of shelf life prediction and actual product shelf life at 7°C can be ranked using the following scale: excellent, >0.90; good, 0.80–0.89; fair, 0.70–0.79 (Bishop, 1988, 1993; White, 1991). Because of low initial numbers of bacteria in freshly pasteurized milk, most shelf life testing consists of preincubating the product (in its original container) at 21°C for 18 h followed by some rapid bacteria-detection method (White, 1991, 1993, 1996).

The Moseley Keeping Quality Test consists of incubating the finished product in its original carton at 7°C for 5–7 days followed by doing the SPC. This test has been used for many years by dairy processors as a way of evaluating the “staying power” of their products. The big drawback is the length of time required for results; that is, 7–9 days before actual counts are obtained. As newer tests to predict shelf life are developed, the tendency is for dairy processors using the Moseley Keeping Quality Test to correlate results of the new test with those of their regular test. This is not the way to evaluate a new test. The results of any test to predict shelf life should be correlated with actual product shelf life, not with the results of another test. Erroneous conclusions may be drawn. Thus, the best testing protocol is a preliminary incubation of the product so any psychro-

trophs present can be enumerated rapidly. Many time and temperature combinations have been evaluated, but the one set of conditions that seems to optimize outgrowth and enumeration of the psychrotrophs is incubation for 18 h at 21°C. Therefore, the preliminary incubation (PI) mentioned in the remainder of this chapter represents 18 h at 21°C.

Some of the proven methods to predict shelf life are as follows:

1. Moseley Keeping Quality Test.
2. PI plus various plating methods: PI + SPC (incubation of plates at 32°C for 48 h); PI + mPBC (incubation of plates at 21°C for 25 h) (mPBC = modified psychrotrophic bacteria count on PCA); PI + CVT (1 L of PCA containing 1 mL of a 0.1% crystal violet solution followed by sterilization, cooling, and addition of 2,3,5-triphenyl tetrazolium chloride [TTC]) (plates are incubated at 21°C for 48 h) (Marshall, 1992); PI + VRBA (incubation of plate at 32°C for 24 h).
3. Bioluminescence.
4. Catalase detection.
5. Limulus amoebocyte lysate (LAL) assay. This procedure involves detection of endotoxins produced specifically by gram-negative bacteria (White, 1993).
6. Impedance microbiology.
7. Dye reduction (HR1, HR2) (H. E. Randolph, personal communication, 1996).
8. Reflectance colorimetry (the LABSMART System, Gary H. Richardson, Logan, UT). This is a tristimulus reflectance colorimeter that monitors dye pigment changes caused by microbial activity.

These methods reflect the most current information about the basics of shelf life prediction techniques. However, no one procedure is ideally suited for every plant application.

Bishop and White (1985) used PI + impedance detection time (IDT) to successfully predict the shelf life of fluid milk. For fluid milk products, the PI + IDT yielded the highest correlation ($r = 0.94$) between test result and actual product shelf life at 7°C. By comparison, the correlation obtained for the Moseley Keeping Quality Test was $r = 0.75$. Because of the 7–9 days required before results are available from the Moseley test and because fluid milk products have a shelf life of approximately 14–21 days at 7°C, there is no question which test would be of more value to the processor. Any of the tests discussed that can give results within 72 h are of more value not only in predicting shelf life but also in controlling the sanitary operation of the plant. Fung (1994), in an excellent overview of rapid detection methods, described 10 attributes of an ideal rapid or automated microbiological assay system for food:

1. *Accuracy*: especially sensitive for false-negative results
2. *Speed*: accurate results within 4 h
3. *Cost*: designed for each application
4. *Acceptability*: must be “official”
5. *Simplicity*: ideally, “dip-stick” technology
6. *Training*: adequate for test or kit
7. *Reagents and supplies*: stability, consistency, availability
8. *Company reputation*: performance of product is critical
9. *Technical service*: rapid and thorough
10. *Space requirements*: should not take up a whole laboratory

Most of the tests discussed meet most of these criteria.

Another method is described by Bishop (1988) as the Virginia Tech Shelf-Life Method (VTSLM), which involves a preliminary incubation (21°C) followed by simple plating. He describes this method as being reliable, accurate, relatively rapid, economical, and familiar to laboratory personnel. He advocates aseptically transferring 10 mL of a pasteurized fluid milk product into a sterile test tube and incubating the tube and its contents at 21°C for 18 h. The sample is then mixed well and diluted 1:1000 with the diluted sample being plated on PCA and incubated at 21°C for 25–48 h. He indicated that this method provides an estimate of the growth potential of psychrotrophic bacteria that may be present in the sample. The time variation for the plate incubation indicates the difference between agar and 3M-Petrifilm methods. If PCA is used, add 50 ppm of a filter sterilized solution of 2,3,5-triphenyl tetrazolium chloride (TTC) to the melted and cooled (44–46°C) agar before pouring plates. Only the red colonies should be counted. Counts can then be extrapolated to indicate estimated shelf life. Shelf life categorization by VTSLM (Bishop, 1988, 1993) follows:

Petrefilm/agar count (cfu/plate)	Total count (cfu/mL)	Estimated shelf life (days)
≤1	≤1,000	≥14
1–200	1,000–200,000	10–14
≥200	≥200,000	≤10

By continuing to do the test to predict shelf life on a regular basis and reacting to the results, confidence can be instilled from quality assurance and production standpoints. Most spoilage of fluid milk–type products occurs from presence of

pseudomonads and related gram-negative bacteria. The tests discussed tend to emphasize detection and enumeration of gram-negative rods.

Gutiérrez et al. (1997) reported on generating monoclonal antibodies against live cells of *Pseudomonas fluorescens*, which were used in an indirect ELISA format to detect *Pseudomonas* spp. and related psychrotrophic bacteria in refrigerated milk. The researchers indicated that development of an ELISA technique using these specific antibodies would facilitate rapid screening of refrigerated milk for detection of high concentrations of bacterial cells. They reported a good correlation ($r = 0.96$) between the colony numbers of psychrotrophic bacteria from commercial milk samples maintained at 4°C by the SPC method and the ELISA technique. These authors stressed the advantages of the indirect ELISA technique as being its versatility, simplicity, and speed.

There is still somewhat of an art in predicting the shelf life of dairy products. Because there is no one perfect test for all needs, processors must carefully select the one or two tests that best fit into their overall quality assurance program. The key points (White, 1991, 1996) regarding prediction of shelf life are as follows:

1. Know the actual potential shelf life of the products as measured at 7°C (45°C).
2. Select the test to predict shelf life that best fits the total program.
3. Routinely do the tests and develop a history, categorizing the results.
4. Ensure top management commitment to define a course of action in case product failure is projected by the tests.

VI. MICROBIOLOGICAL TESTING OF MILK AND NONCULTURED PRODUCTS

A. Fluid Milk Products

Shelf life becomes critical for fluid milk products. Shelf life of pasteurized milk has been defined (White, 1991) as the time between packaging and when the milk becomes unacceptable to consumers. Because the actual product shelf life is between 10 and 21 days at 7°C, rapid shelf life prediction tests, as discussed previously, become critical. Dairy processors generally do a good job of cleaning and sanitizing; thus the number of contaminating bacteria (psychrotrophs) is so small that some form of preincubation is required to obtain numbers large enough for rapid detection tests to enumerate them.

For the reasons just stated, the following are recommended for microbiological testing of fluid milk-type products:

1. *Estimation of coliforms*. At a minimum, a coliform (VRBA) test should be done on representative samples of all fresh products. H. E. Randolph (personal

communication, 1996) and I agree that a better test would be a ‘‘stress’’ coliform test wherein the product is incubated at 21°C for 18 hours followed by coliform estimation on VRBA. According to *Standard Methods for Examination of Dairy Products* (Marshall, 1992), plates are incubated at 32°C and counted after 24 h of incubation (Figs. 7 and 8). The PI-VRBA allows for outgrowth of heat-injured coliforms, which might not show up on a coliform count made directly on fresh products. Petrifilm or VRBA agar in regular Petri dishes may be used. Whereas VRBA agar is normally used for detection of coliforms, PI allows for detection of some psychrotrophic types that may be present.



Figure 7 Coliform plating (using the Petrifilm system) being conducted by QA technician. (Photograph courtesy of Mayfield Dairies and Dean Foods Company, Athens, TN.)



Figure 8 QA technician checks for presence of coliforms in finished products. (Photograph courtesy of Mayfield Dairies and Dean Foods Company, Athens, TN.)

2. *Shelf life prediction tests.* Any of the shelf life prediction tests discussed previously may be used. Specifically, it is recommended to use one of the following: PI + SPC (18 h at 21°C plus 48 h of plate incubation at 32°C); PI + CVT (product incubation for 18 h at 21°C followed by incubation of crystal violet tetrazolium agar for 48 h at 21°C); PI + other rapid detection methods, for example, PI + bioluminescence, PI + impedance detection, and PI + reflectance colorimetry. These other systems can be very effective and accurate in predicting shelf life. Because of the cost of some of the systems, it may be necessary to use them for more than one test, such as for raw milk evaluation, equipment cleanliness, and culture viability in addition to shelf-life prediction. Smithwell and Kailasapathy (1995) described a rapid test for detection of psychrotrophs wherein milk is mixed with a selective agent (benzalkonium chloride) and a bacterial indicator (tetrazolium salt) and incubated at 30°C. The researchers indicated that gram-positive bacterial growth is suppressed by the benzalkonium chloride, and they stipulated that, if gram-negative bacteria are present, they grow and multiply. Once the numbers reached approximately 10^7 /mL, the tetrazolium salt is reduced and the color of the milk changes from white to red. This is similar to the HR1-HR2 test described by H. E. Randolph (personal communication, 1996). The authors caution that the time required for this color

reaction to occur depends on the amount of milk examined and the level and activity of bacteria present. These reduction-type tests lack the sophistication of some of the other test methods, but they do have the major benefit of being visible so shelf life tests can be observed by plant employees. This increases the interest by plant personnel in the sanitary processing and packaging of their fluid milk products.

3. *Sensory evaluation of representative samples of fresh product.* Milk from all fillers and all labels should be tasted fresh. Samples can be combined to minimize the total number of samples that need to be discarded.

4. *Sensory evaluation at end of shelf life.* Samples need to be tasted at some point at or beyond the code date. This time can be extended as shelf life of the product improves. Many dairies express this type of evaluation in terms of a certain percentage of products that are good (or bad) after a certain number of days at 7°C (45°F). Ideally, 100% of the products would be good when evaluated at day 21. As a rule, the number of days in which 90% or more of the products remain good can be used. Thus, a dairy may start out testing after 10 days at 7°C until success is achieved on a continual basis in 90% or more products being good. Subsequently, the sensory evaluation may be gradually moved to anywhere from 14 to 21 days until continual success is noted. If new shelf life problems occur, evaluations may have to revert to a shorter time to achieve satisfactory results.

The quality of the raw milk, as discussed previously, is still a very important issue. Celestino et al. (1996) indicated that storage of bulk raw milk resulted in increased numbers of lipolytic and proteolytic bacteria. They found that, on the average, the number of psychrotrophs as a proportion of the total plate count increased from 47% to 80% after 2 days of storage at 4°C. Thus, finished product quality can definitely be affected if raw milk is stored for too long a time (legally no more than 72 h, ideally no more than 48 h) (see Chapter 2).

B. Cottage Cheese—Noncultured Dressing

In evaluating the microbiological quality of cottage cheese, the places where cottage cheese could become contaminated (from a keeping quality standpoint) must be considered. There are only three things that consistently cause shelf life problems to the cottage cheese industry:

1. *Wash water.* The wash water must have proper pH and chlorine level.
2. *Dressing.* The cream dressing, whether for full-fat, low-fat, or nonfat cottage cheese, affects the quality of the finished product. If the dressing contains many psychrotrophic bacteria, the desired shelf life will not be obtained. This is especially true in dressings to which no culture has been added.

3. *Packaging operation.* The blending of curds and dressing and filling of cottage cheese cartons constitute excellent opportunities during which psychrotrophic bacteria can gain entry into the finished product. Great care must be exercised to ensure that only cleaned and sanitized food contact surfaces are being used.

These three areas hold true whether the cottage cheese operation is very small with all operations other than packaging being handled within the cheese vat or whether the operation is large with separate washer coolers, blenders, and packaging machines. Thus, samples should routinely be taken to ensure the microbial quality of each of these areas. First, daily samples of the wash water should be obtained and plated for coliforms and psychrotrophic bacteria (by any of the methods discussed previously). Second, daily samples should be obtained of the dressing and tested to ensure microbiological quality. Again, both coliform and psychrotrophic testing should be done. Third, a statistically valid number of samples should be used to evaluate finished product quality. (See previous discussion of this subject in this chapter; see also Chapter 11.)

In other words, cottage cheese with noncultured dressing should be handled very similarly to fluid milk products. If cultured dressing is used, the primary test to use is a coliform (VRBA) test on the fresh product.

With regard to how cottage cheese should be sampled, *Standard Methods for Examination of Dairy Products* (Marshall, 1992) prescribes the use of a sterile blender-container on a balance and tared to which 11 g of cottage cheese are added aseptically along with 99 mL of warmed (40–45°C), sterile 2% sodium citrate solution. The sample is blended for 2 min, after which the product is diluted (if needed) and plated. Also, a Stomacher might be used (11 g of sample and 99 mL of diluent) to blend the cheese sample.

Another method used by some dairies for microbiological examination of cottage cheese is simply plating the dressing found in the container of finished product. This works for some freshly dressed cheeses, but many cheeses do not have enough dressing from which separate extractions can be made. In these instances, blending the cheese either in a sterile blender or in a Stomacher is necessary.

C. Frozen Dairy Desserts

The microbiological evaluation of frozen dairy desserts consists of two basic parts: (a) ingredients and mix samples and (b) finished product. Some of the ingredients used in ice cream that should be tested microbiologically include fluid dairy products, dry dairy products (especially nonfat dry milk and whey powder), fruits, nuts, colors, flavors, stabilizers, and emulsifiers (see also Chap. 4).

Fruits and nuts may be weighed (Marshall, 1992) into wide-mouth containers (11-g portions should be used) to which 99 mL of dilution water is added. The mixture is soaked for 5 min, shaken vigorously, and plated. The recommended tests to be used for these type products are:

1. Coliform count on fresh samples.
2. Yeast and mold counts (see *Standard Methods for Examination of Dairy Products* [Marshall, 1992]). Probably the most commonly used medium for yeast and mold counts is acidified potato dextrose agar. These plates must be incubated at 25°C for 5 days with counted plates having between 15 and 150 colonies.
3. SPC.

All fluid milk products, including fluid milk, cream, and condensed skim and whole milk, are plated as described previously.

Stabilizers and emulsifiers should be plated using 1 g in 99 mL of dilution water (Marshall, 1992). The sample is shaken vigorously for 15 s and allowed to hydrate at 20–40°C for up to 20 min. The product is then plated for SPC and coliform count (VRBA).

For finished products, a statistically valid number of samples representing each type of product and each label change should be obtained. Finished product samples should be thawed at a temperature of up to 40°C for no more than 15 min (Marshall, 1992). A coliform count on fresh product is a good indication of whether sanitary methods were used in processing and handling the mix and finished product. Psychrotrophs can also be a problem. White and Marshall (1973) indicated that heat-stable enzymes produced by typical psychrotrophs could cause a measurable effect on ice cream mix that approached significance from a sensory evaluation standpoint (see Chap. 4).

D. Butter

By definition, butter must contain at least 80% milk fat. It seems, then, that the microbiological quality of butter is not as critical as it is with other dairy products, yet microorganisms can and do survive and grow quite well in butter and related products. White and Marshall (1973) evaluated the effect of heat-stable proteases on several dairy products, including butter. They did not find any significant effect of the proteases. This is not surprising, because butter contains only about 1% protein. Microorganisms with high lipolytic activity would be expected to have a greater effect on high-fat products. *Standard Methods for Examination of Dairy Products* (Marshall, 1992) lists the following tests that can be done on butter or margarine-type products: SPC, coliform count (VRBA), proteolytic count, psychrotrophic count, lipolytic count, *Enterococcus* count, and yeast and

mold counts. Furthermore, I and other authors (R. Baer, personal communication, 1997; R. L. Richter, personal communication, 1997) recommend the following tests be done routinely in a creamery operation (all counts should be reported on a per gram of butter basis):

1. SPC (1:1000 dilution as recommended by *Standard Methods for Examination of Dairy Products* [SM]).
2. Coliform count (VRBA-1:2-1:10 dilution-SM).
3. Lipolytic count (1:100 dilution-SM).
4. Yeast and mold count (1:2-1:10 dilution-SM). Wilster (1957) recommended a standard of 50 yeast and molds per gram of melted butter. This seems high for present-day circumstances (see Chapter 5).

E. Dry Milk and Whey Products

Dry dairy ingredients are used in a wide variety of products, including other food products as well as dairy products. The quality of the finished products can be affected by the quality of these milk ingredients. Nonfat dry milk adds many desirable properties to dairy foods; however, these desirable properties are minimized when inferior powders are used. The same may be said of the use of sweet whey powder and especially the newer whey protein concentrates and whey protein isolates. These ingredients may be purchased in various amounts, but typically the product arrives in 40- to 50-lb bags or even in totes.

With regard to microbiological analyses, most dairies are performing the SPC and coliform count (VRBA). Three to 5 mL of agar overlay may be used on surfaces of solidified plates before incubation if spreading of colonies is a problem when these products are tested (Marshall, 1992). With a dried product that has obviously been exposed to some heat treatment, the presence of spore-forming bacilli can be common. Also, the DMC may be used to evaluate incoming samples of nonfat dry milk and whey products. Typically, this analysis is done by making a 1:10 dilution (11 g of product in 99 mL dilution water) of the sample before it is examined microscopically. *Standard Methods for Examination of Dairy Products* (Marshall, 1992) recommends the use of 2% sodium citrate solution in making these 1:10 dilutions if certain samples dissolve less readily. The reports would show as DMC/g of NDM or whey powder (see Chap. 3).

F. Ultra-High-Temperature Products

With a commercially sterile product, the presence of any microorganisms able to grow under conditions of product storage is considered detrimental to the shelf

life of the product. Also, because the product normally is held at ambient temperatures, any slight contamination during the aseptic packaging process will damage the product.

Bockelmann (1989) indicated that, under current circumstances, the reject rate for ultra-high temperature (UHT)-type products is approximately 1 defective (unsterile) unit per 100,000 produced packages. To improve beyond this point, for example, to achieve a reject rate of 1/100,000,000, would be impossible because of construction limits of the equipment (Bockelmann, 1989). He stated that for UHT plants in use at that time, sterilization effects of between 10 and 12 could be assumed. He said that of 10^{10} – 10^{12} bacteria spores fed into the process, 1 spore would survive, and that the microbiological end result of such a process was dependent on (a) the sterilization effect of the UHT process and (b) the bacterial spore count in the raw product.

Thus, the number of bacterial spores present in raw milk is of definite importance when dealing with a “sterile” finished product. According to *Standard Methods for Examination of Dairy Products* (Marshall, 1992), 200 mL of raw milk should be placed in a sterile Erlenmeyer flask with a screwcap lid. The milk should be heated to 80°C for 12 min and then cooled immediately in an ice bath and plated on PCA with added starch and plates incubated at 32°C for 48 h. Even though the plates could be incubated at 7°C for 10 days for psychrotrophic spore counts, the mesophilic spore count as just outlined should provide more meaningful information on UHT-type products.

For finished product testing, *Standard Methods for Examination of Dairy Products* (Marshall, 1992) recommends swabbing the outside surface of the finished product container with 70% alcohol. The needle of a sterile, single-service hypodermic syringe should then be inserted through the package wall and the appropriate amount of sample removed. Because the product is thought to be sterile, precise measurements are normally not needed, because any contamination is considered bad.

Bockelmann (1989) used the sterilization effect and the maximum acceptable defect rate as a means of establishing the following proposed standard for spore counts in raw materials such as raw milk:

Standard spore count in raw materials (UHT sterilization effect: approximately 11; maximum acceptable defect rate: 1:1000)

No. surviving per milliliter	Aim	Action	Limit
10 min, 80°C	<100	– 1,000	– 10,000
10 min, 100°C	<10	– 100	– 1,000

With regard to packaging material for UHT products, Bockelmann (1989) indicated the infection rate resulting from the manufacturing process of these packaging materials to be insignificant (i.e., 0.5 microorganism/100 cm²), about 3–5% of the bacteria were identified as *Bacillus* spores.

Bernard (1983) made several observations on some of the other microbiological considerations for testing aseptic processing and packaging systems. He indicated that, before establishing appropriate times, temperatures, and exposure concentrations to provide for commercial sterility, appropriate test organisms must be determined for each particular sterilization medium. Some of the test organisms for the different sterilization media are as follows:

Sterilization medium	<i>Bacillus</i> spp.
Superheated system	<i>B. stearothermophilus</i> (1518) <i>B. polymyxa</i> (PSO)
H ₂ O ₂ and heat	<i>B. subtilis</i> strain A
H ₂ O ₂ and UV	<i>B. subtilis</i> strain A

In addition to the sensory and physical/chemical testing done on UHT finished products, microbiological testing is also critical. Edwards (1983) indicated that SPCs and coliform counts, among other tests, of aseptically processed products done immediately after packaging are ineffective as quality control procedures because of the extremely low number of viable organisms present in an unsterile container and due to the very low numbers of unsterile containers. He said that, to provide a more effective and more rapid method of detecting these low numbers of viable organisms, samples are typically incubated at an elevated temperature (e.g., 35°C [95°F]) to allow for rapid growth of most microorganisms that might be present. He stressed that incubation time may vary depending on product characteristics and types of tests to be used to detect nonsterility. It is necessary to incubate UHT samples at an elevated temperature (e.g., 35°C) for approximately 1–3 days. Even if bacteria have been substantially heat injured, this time-temperature combination allows for outgrowth of any survivors. Also, this combination facilitates early detection of enzymes, especially the proteases.

Edwards (1983) indicated that there are two types of samples that should be obtained: (a) aimed samples and (b) random or timed samples. Aimed samples are obtained when the risk of contamination is greater than during normal operations such as during start-up and splices. Evaluation consists of container integrity tests and product incubation. Random or timed samples are obtained during normal operation. Evaluation of these samples consists of container integrity tests, product incubation, and shelf life monitoring.

These samples should be obtained at different locations such as after the packaging machine, after the downstream equipment, and from the warehouse (Edwards, 1983). If nonsterility is observed, resampling of the product should be done from that period, with evaluation by container integrity tests and product incubation. The defect rate in the aseptic processing and packaging systems, which Edwards (1983) said was the most common, was 1 in 10,000, and some of the sources of nonsterility were inadequate heat treatments of the product, inadequate equipment sterilization, contamination of equipment after sterilization, inadequate package sterilization, contamination of package after sterilization, faulty package material, nonhermetical seal, improper machine adjustment, damage from downstream equipment, and damage from handling and shipping (see also Chap. 2).

VII. MICROBIOLOGICAL TESTING OF CULTURED DAIRY PRODUCTS

In this discussion, cultured dairy products include cultured milk (buttermilk), cultured or acidified cottage cheese, cultured or acidified sour cream, and yogurt. A total count or SPC is not suitable for measuring the microbiological quality of these products, because a viable bacterial culture has been added to each of them. Even for noncultured cottage cheese dressings, an SPC on fresh product is meaningless because of the low numbers of microorganisms present after pasteurization. Thus, the coliform count (VRBA) is the primary microbiological test that is used in evaluating cultured dairy products.

For any of the cultured milks (e.g., whole, low-fat, or skim buttermilk), the coliform count may be determined by plating 1:1 on VRBA. With regard to cottage cheese, ideally, the product should be blended in a sterile blender. *Standard Methods for Examination of Dairy Products* (Marshall, 1992) recommends the use of a sterile spatula to aseptically transfer 11 g of cottage cheese into the sterile blender, which had been preweighed. Then, 99 mL of warmed (40–45°C), sterile 2% sodium citrate solution is added. The product is then thoroughly mixed for 2 min. The product is then plated with 1 mL of the blended 1:10 dilution being transferred to a VRBA plate (or Petrifilm).

As discussed previously, an alternative method used by some dairy plant laboratories to test for the presence of coliforms in cottage cheese is simply to plate the dressing directly out of the cottage cheese carton. This can be somewhat difficult, especially if the cottage cheese is relatively dry. Blending yields more consistent results.

Goel et al. (1971) evaluated the duration that coliforms would survive in yogurt, buttermilk, sour cream, and cottage cheese during refrigerated storage. They noted a marked decrease in numbers of most coliforms tested in

yogurt, buttermilk, and sour cream after 24 h of storage at 7.2°C. Hence, there is a definite need to test for the presence of coliforms in these type products within 24 h of manufacture and packaging. With cottage cheese, there was less of a decrease in numbers of coliforms than for the other cultured dairy products. Barber and Fram (1955) cautioned that coliform-like colonies on VRBA should be confirmed for yogurt and other products containing fruit or added sweetener.

Also, yeast and mold counts are done by some dairies on some of the cultured dairy products. These counts could be done on buttermilk, cottage cheese, or yogurt. Many times yogurt develops a yeast or mold problem as opposed to any bacterial-related shelf life-ending problems. *Standard Methods for Examination of Dairy Products* (Marshall, 1992) lists the following media to be used for yeast and mold enumerations: (a) acidified potato dextrose agar, (b) yeast extract–dextrose–chloramphenicol agar, and (c) dichloran–Rose Bengal–chloramphenicol (DRBC) agar. In addition, Petrifilm provides a yeast and mold agar that is used by many dairy laboratories.

The most common flavor criticism of cottage cheese, sour cream, and buttermilk-type products is that they “lack flavor” or are “flat.” Because the incubation time or temperature has not allowed the culture of bacteria to produce sufficient flavor, the resulting product tends to have a flat flavor. Because of this, the presence of any contaminating microorganisms, especially coliform, or psychrotroph-type bacteria, or yeast and molds, can cause relatively slight off-flavors to become more pronounced because of the absence of competing desirable flavor notes. Extreme effort should be made to enhance bacterial starter (e.g., acid and diacetyl) activity to the point where desirable flavors may be noted in products such as sour cream and buttermilk (see also Chap. 9).

VIII. MICROBIOLOGICAL TESTING OF RIPENED CHEESES

Natural cheeses, regardless of variety, readily support growth of many microorganisms even though moisture content, salt content, pH, and other compositional factors vary from cheese to cheese. Cheeses may contain pathogenic bacteria (e.g., *Listeria monocytogenes*, *Staphylococcus aureus*, *Salmonella* (see Chaps. 11 and 13). This is the exception and not the rule, because cheese is a concentrated dairy product, and if all “make” procedures have been followed and good manufacturing practices adhered to, the probability of foodborne pathogens being present is remote. This is true of Cheddar cheese, for example, as long as the pH in the finished product is controlled (<5.3).

Standard Methods for Examination of Dairy Products (Marshall, 1992) recommends any one of three procedures to mix a cheese sample for subsequent microbiological analysis:

1. Transfer 11 g of cheese into 99 mL of sterile aqueous 2% sodium citrate at 40–45°C. The cheese is then blended for 2 minutes and plated either direct (1:10) or with further dilutions.
2. Weigh 1 ± 0.01 g into a presterilized 177-mL Whirl-Pak bag (NASCO, Inc., Fort Atkinson, WI). The cheese is then macerated, after which 9 mL of 2% sodium citrate at 40°C is added. The bag is closed with the contents rolled and then plated.
3. Eleven grams of cheese and 99 mL of diluent are mixed in a Stomacher 400 (Dynatech Laboratories, Inc., Alexandria, VA). The cheese is blended for 2 min then plated.

Microbiological tests that are done on hard cheese may vary from one processor to another; however, the coliform count and the *Staphylococcus* count should be done. *Staphylococcus* counts are especially critical when there is an abnormally high pH value. It is recommended that a *Staphylococcus* count be automatically done on any Cheddar-type cheese with a pH greater than 5.2.

Interpretation of the coliform count is the same as for any dairy product, that is, a high count indicates unsanitary conditions involved in processing and packaging the product. As discussed previously, coliforms are “indicator organisms.” This means that the occurrence of coliforms indicates that conditions are suitable for the presence of enteric pathogens. This does not mean that pathogens are definitely present but that the cheese was handled in a manner that allows enteric pathogens to be present. Coliforms are important indicators, and hence this test should not be ignored.

IX. FUTURE OF MICROBIOLOGICAL TESTING OF DAIRY PRODUCTS

There is a tremendous amount of work being done regarding development of rapid detection methods for total numbers of both bacteria and specific organisms, primarily pathogens. Karwoski (1996) and Fung (1994, 1995) discussed different areas of research in food microbiology, and a summary follows of what these two investigators have reported:

1. Sample preparation: Two useful instruments in this area are the Stomacher and the Gravimetric Diluter (Spiral Biotech, Bethesda, MD).
2. Total viable cell count: Various alternatives include the following (White, 1996): Automated spiral plating method (Spiral Biotech, Bethesda, MD); Isogrid System (QA Laboratories, Ltd., San Diego, CA) (all colonies have square shape, reported to be easier to count); Petrifilm (3M Co., St. Paul, MN); Redigel System (RCR Scientific, Inc., Goshen, IN); and Direct epifluorescent filter technique (DEFT)

slides read by systems such as the Bio-Fos Automated Microbiology System (FOS Electric, Denmark).

3. Differential cell count.
4. Pathogenic organisms.
5. Enzymes and toxins.
6. Metabolites and biomass.

In an article dealing with microbiological testing in the dairy industry, White (1996) summarized some of the methods that Fung had reviewed. Some of these methods are as follows:

1. Microbial ATP detection: Bioluminescence (Celsis, Evanston, IL; Cogent Technologies, Ltd., Cincinnati, OH) as a screening tool for accepting raw milk shows great promise. Reybroeck and Schram (1995) outlined a test that took less than 6 min. They described this method as being very useful as a sensitive and rapid semiautomatic method for fast microbiological screening of raw milk on arrival at a dairy plant.
2. Impedance detection in foods (Bactometer, bioMérieux, Vitek, Inc., Hazelwood, MO; Malthus System, Crawley, UK).
3. Omnispec Bioactivity Monitor System (Wescor, Inc., Logan, UT): A tristimulus reflectance colorimeter monitors dye pigment changes caused by microbial activity. The LABSMART System highlights this use of reflectance colorimetry.
4. Catalase test: This test is very useful in detecting strongly catalase-positive bacteria, such as pseudomonads.
5. Many miniaturized diagnostic kits for identification of microorganisms (e.g., API, Enterotube, R/B, Minitek, MicroID, and IDS).
6. Genetic techniques (Fung, 1995): DNA/RNA probes are a sensitive method for detection of pathogens (e.g., *Listeria* and *Salmonella* detection using The Gene-Trak Assay System [Gene-Trak Systems, Framingham, MA]). Sensitivity 1×10^5 organisms per milliliter broth (Giese, 1995). Wolcott (1991) indicated that polymerase chain reaction (PCR) has become the preferred method for amplifying DNA. This enables detection of target microorganisms in hours rather than days. This procedure has tremendous potential in all areas of food microbiology, including dairy microbiology. The BAX System (Dupont Experimental Station, Wilmington, DE) for screening *Salmonella* is one example.
7. Enzyme-linked immunosorbent assay (ELISA), systems produced in the United States by Organon Teknika (Durham, NC), use monoclonal antibodies as a diagnostic test, especially for foodborne pathogens. Development of the ELISA technique using monoclonal antibodies spe-

- cific to *Pseudomonas* and related psychrotrophic bacteria as outlined by Gutiérrez et al. (1997) shows great promise.
8. Vitek Immuno Diagnostic Assay System (VIDAS): A multiparametric immunoanalysis system that uses the enzyme-linked fluorescent immunoassay (ELFA) method. All intermediate steps are automated (Fung, 1994).

There continues to be a need for methods that can rapidly detect the presence of certain types of bacteria. Personnel at a dairy plant must be able to determine whether equipment is clean, to screen rapidly all incoming raw ingredients, and to predict rapidly (<24 h) the shelf life of finished products. By monitoring raw ingredients, monitoring the processing and packaging environment, and providing a more limited testing of finished products, a dairy processor becomes much more proactive in eliminating safety and quality hazards.

Other innovations such as addition of carbon dioxide to milk and other dairy products such as cottage cheese serve to extend the shelf life of the products (Hotchkiss and Chen, 1996; Sierra et al., 1996). Certain questions have been raised that relate to packaging for such products (e.g., high-barrier films being required to retain the CO₂).

Thus, much has changed in the testing of milk and milk products by dairy processors. Environmental samples for pathogens are commonly being sent to commercial testing laboratories, more sophisticated equipment is being found in the laboratories, and many of the laboratories are becoming larger because of consolidation and takeovers of smaller operations. However, one significant fact cannot be forgotten: For the dairy industry continually to provide safe, long-lasting products to the American consumer, rapid, accurate, and reliable testing must be done. It is extremely important for management to react to the data provided by this testing. As confidence is gained by quality assurance personnel and production management, the American consumer will continue to receive dairy products that are as good and safe as products produced anywhere in the world.

REFERENCES

- Adams DM, Barach JT, Speck ML. Heat resistant protease produced in milk by psychrotrophic bacteria of dairy origin. *J Dairy Sci* 58:828, 1975.
- Adams DM, Barach JT, Speck ML. Effect of psychrotrophic bacteria from raw milk on milk proteins and stability of milk proteins to ultrahigh temperature treatment. *J Dairy Sci* 59:823, 1976.
- Babel FJ. Activity of bacteria and enzymes in raw milk held at 4.0°C (abstr). *J Dairy Sci* 36:562, 1953.

- Barach JT, Adams DM, Speck ML. Low temperature inactivation in milk of heat-resistant proteases from psychrotrophic bacteria. *J Dairy Sci* 59:391, 1976.
- Barber FW, Fram H. The problem of false coliform counts on fruit ice cream. *J Milk Food Technol* 18:88–90, 1955.
- Bautista DA, McIntyre L, Laleye L, Griffiths MW. The application of ATP bioluminescence for the assessment of milk quality and factory hygiene. *J Rapid Methods Automat Microbiol* 1:179–193, 1992.
- Bernard D. Microbiological considerations of testing aseptic processing and packaging systems. In: *Proceeding: Capitalizing on Aseptic*. NFPA Conference, Washington, DC, 1983.
- Bishop JR. Establish a dairy product quality assessment program. *3M*, Oct. 1988.
- Bishop JR. Estimating shelf-life: A basic part of total dairy quality assurance. *UW Dairy Pipeline* 5(2):1, 1993.
- Bishop JR, White CH. Estimation of potential shelf-life of pasteurized fluid milk utilizing bacterial numbers and metabolites. *J Food Prot* 48:663, 1985.
- Bishop JR, White CH. Assessment of dairy product quality and potential shelf-life: a review. *J Food Prot* 49:739, 1986.
- Bockelmann BV. Quality control of aseptically packaged food products. In: Reuter H, ed. *Aseptic Packaging of Food*. Lancaster, PA: Technomic Publishing, 1989, pp 237–243.
- Byrne RD Jr, Bishop JR, Boling JW. Estimation of potential shelf-life of pasteurized fluid milk utilizing a selective preliminary incubation. *J Food Prot* 52:805, 1989.
- Celestino EL, Lyer M, Roginski H. The effects of refrigerated storage on the quality of raw milk. *Aust J Dairy Technol* 51:59, 1996.
- Champagne CP, Laing RR, Roy D, Mafu AA, Griffiths MW. Psychrotrophs in dairy products: their effects and their control. *Crit Rev Food Sci Nutr* 34:1, 1994.
- Edwards J. Q. A. Programs for processors and packages: low acid foods. In: *Proceedings: Capitalizing on Aseptic*. NFPA Conference, Washington, DC, 1983.
- Flickinger B. Plant sanitation comes to life: an evaluation of ATP-bioluminescence systems for hygiene monitoring. *Food Qual* 2(Jun–Jul):22, 1996.
- Fung DYC. Rapid methods and automation in food microbiology: a review. *Food Rev Int* 10:357, 1994.
- Fung DYC. What's needed in rapid detection of foodborne pathogens. *Food Technol* 49(6):64, 1995.
- Giese J. Rapid microbiological testing kits and instruments. *Food Technol* 49(7):64, 1995.
- Goel MC, Kulshrestha DC, Marth EH, Francis DW, Bradshaw JG, Read RB Jr. Fate of coliforms in yogurt, buttermilk, sour cream, and cottage cheese during refrigerated storage. *J Milk Food Technol* 34:54, 1971.
- Griffiths MW. The role of ATP-bioluminescence in the food industry: new light on old problems. *Food Technol* 50:62, 1996.
- Griffiths MW, McIntyre L, Sully M, Johnson I. Enumeration of bacteria in raw milk. In: Stanley PE, Kricka LJ, eds. *Bioluminescence and Chemiluminescence, Current Concepts*. Chichester, UK: Wiley, 1991, pp 479–482.
- Griffiths MW, Phillips JD. The application of the pre-incubation test in commercial dairies. *Aust J Dairy Technol* 4:171–179, 1986.

- Guinot-Thomas P, Al-Ammoury M, LeRoux Y, Laurent F. Study of proteolysis during storage of raw milk at 4°C: effect of plasmin and microbial proteinases. *Int Dairy J* 5:685, 1995.
- Gutiérrez R, González I, García T, Carrera E, Sanz B, Hernandez PE, Martin R. Monoclonal antibodies and an indirect ELISA for detection of psychrotrophic bacteria in refrigerated milk. *J Food Prot* 60:23, 1997.
- Hotchkiss J, Chen JH. Microbiological effects of the direct addition of CO₂ to pasteurized milk (abstr). *J Dairy Sci* 79(suppl 1):87, 1996.
- Johns CK. Preliminary incubation for raw milk samples. *J Milk Food Technol* 23:137, 1960.
- Johnson P., Randolph Associates, 2000.
- Karwoski M. Automated direct and indirect methods in food microbiology: A literature review. *Food Rev Int* 12:155, 1996.
- Marshall RT, ed. *Standard Methods for the Examination of Dairy Products*. 16th ed. Washington, DC: American Public Health Association, 1992.
- Martin JH. Significance of bacterial spores in milk. *J Milk Food Technol* 37:794, 1974.
- Martin JH. Heat resistant mesophilic microorganisms. *J Dairy Sci* 64:149, 1981.
- Maxcy RB, Liewen MB. Function of preliminary incubation of raw milk samples for quality control. *J Dairy Sci* 72:1443, 1989.
- Pahauski E, Martin L, Stebritz K, Priest J, Dimond R. Rapid concentration procedure for microorganisms in raw milk. *J Food Prot* 54:813, 1991.
- Prosser JI, Killham K, Glover LA, Rattray EAS. Luminescence-based systems for detection of bacteria in the environment. *Crit Rev Biotechnol* 16:157, 1996.
- Reybroeck W, Schram E. Improved filtration method to assess bacteriological quality of raw milk based on bioluminescence of adenosine triphosphate. *Neth Milk Dairy J* 49:1, 1995.
- Rollema HS, McKellar RC, Sorhaug T, Suhren G, Zadow JG, Law BA, Poll JK, Stepaniak L, Vagias G. Comparison of different methods for the detection of bacterial proteolytic enzymes in milk. *Milchwissenschaft* 44:491, 1989.
- Sierra I, Prodanoy M, Calvo M, Olano A, Vidal-Valverde C. Vitamin stability and growth of psychrotrophic bacteria in refrigerated raw milk acidified with carbon dioxide. *J Food Prot* 59:1305–1310, 1996.
- Smithwell N, Kailasapathy K. Psychrotrophic bacteria in pasteurized milk. Problems with shelf-life. *Aust J Dairy Technol* 50:28–31, 1995.
- Sutherland AD, Bell C, Limond A, Deakin J, Hunter EA. The Biotrace method for estimating bacterial numbers in milk by bioluminescence. *J Soc Dairy Technol* 47:117, 1994.
- White CH. The art and science of predicting shelf-life. *Dairy Field* 4:24–25, 1991.
- White CH. Yogurt and fermented milk drinks. Presented at International Symposium on Dairy Science and Technology, Canilec, Mexico, 1992.
- White CH. Rapid methods for estimation and prediction of shelf-life for milk and dairy products. *J Dairy Sci* 76:3126, 1993.
- White CH. Microbiological testing in the dairy industry. *Food Testing Anal* 2(Aug–Sept): 22, 1996.
- White CH, Marshall RT. Reduction of shelf-life of dairy products by a heat-stable protease from *Pseudomonas fluorescens* P26. *J Dairy Sci* 56:849, 1973.

- Wilster GH. Practical Buttermaking. 8th ed. Corvallis, OR/OSC Cooperative Association, 1957, pp 9, 230.
- Witter LD. Psychrophilic bacteria: A review. *J Dairy Sci* 44:983, 1961.
- Wolcott MJ. DNA-based rapid detection methods for the detection of foodborne pathogens. *J Food Prot* 54:387, 1991.
- Zall RR, Chen JH, Murphy SC. Effects of heating and storing milk in milk plants before pasteurization. *Cult Dairy Prod J* 17(4):5-9, 1982.

18

Treatment of Dairy Wastes

W. L. Wendorff

*University of Wisconsin–Madison
Madison, Wisconsin*

I. INTRODUCTION

Dairy plants process a wide variety of products including milk, cheese, butter, ice cream, yogurt, nonfat dry milk, whey, and lactose. The volume and composition of dairy wastes from each plant depends on the types of products produced, waste minimization practices, types of cleaners used, and water management in the plant. Because most dairy plants process several milk products, waste streams may vary widely from day to day. The main source of dairy effluents are those arising from the following:

1. Spills and leaks of products or by-products
2. Residual milk or milk products in piping and equipment before cleaning
3. Wash solutions from equipment and floors
4. Condensate from evaporation processes
5. Pressings and brines from cheese manufacture

Dairy plant operators may choose from a wide variety of methods for treating dairy wastes from their plants. This may range from land application for small plants to operation of biological wastewater treatment systems for larger plants. Some dairy plants may pretreat the effluents and discharge them to a municipal wastewater treatment plant. Dairy wastes are segregated and treated separately from sanitary wastes generated in employee facilities. The objectives of treating dairy wastes are to (a) reduce the organic content of the wastewater, (b) remove or reduce nutrients that could cause pollution of receiving surface

waters or groundwater, and (c) remove or inactivate potential pathogenic microorganisms or parasites.

The level of treatment needed for dairy wastewater for each plant is dictated by the environmental regulations applicable to the location of the dairy plant. The Environmental Protection Agency (EPA) establishes general regulations concerning discharges to surface waters and groundwater. Each state environmental regulatory agency is responsible for ensuring compliance with those regulations. Each plant must have a discharge permit for each outfall discharging to surface waters. The limits within that permit depend on the flow and type of surface water into which the treated wastewater is discharged. If a plant discharges wastewater to municipal sewers for treatment, the municipal treatment system may require pretreatment of high-strength wastes to bring the waste load down to domestic sewage strength. This allows for proper treatment of wastewater before it is discharged to surface water. For land applications, state regulatory agencies dictate hydraulic loadings and maximum levels of toxic substances that can be landspread on each unit of land.

II. DAIRY PLANT EFFLUENTS

A. Quantity of Dairy Wastes

Wastes from manufacture of milk products contain milk solids in various concentrations. Up to 5% of the milk received by a dairy plant may be lost in waste discharges from the plant (Carawan et al., 1979; Harper and Blaisdell, 1971; Harper et al., 1985). Typical product losses for fluid milk and ice cream plants are listed in Table 1. With increased environmental restrictions, dairy plants have instituted waste minimization procedures to reduce the loss of milk solids and improve use of milk by-products (Danalewich et al., 1998; Harper and Carawan, 1978; Harper et al., 1985; Wendorff, 1995). These water and waste management programs also emphasize water conservation practices in plants to reduce the overall volume of dairy wastes that need to be treated.

B. Composition of Dairy Wastes

Because more than 95% of the waste load from dairy plants comes from milk or milk products, it is of value to know the average composition of these products (Table 2). Milk solids are primarily composed of fats, proteins, and carbohydrates. Other constituents in dairy wastewater may include sweeteners, gums, flavoring, salt, cleaners, and sanitizers.

Biochemical oxygen demand (BOD) is the amount of dissolved oxygen (DO) consumed by microorganisms for biochemical oxidation of organic solids in wastewater. The analytical procedure for determining BOD measures dissolved

Table 1 Product Losses for Fluid Milk and Ice Cream Processing Plant

Process	Product losses	
	Fluid milk (%)	Ice cream (%)
Receiving	0.23	0.20
Separation	0.75	—
Clarification	0.08	—
Milk storage	0.44	0.28
Standardizing	—	0.08
Blending	—	0.10
Pasteurization	0.58	1.00
Pasteurized storage	0.25	0.40
Flavoring and fruit	—	0.30
Freezing	—	0.50
Filling	0.50	0.75
Conveying	0.10	0.40
Hardening	—	0.04
Storage	0.10	0.04
Miscellaneous	0.30	0.04
Total	3.33	4.13

Source: Harper et al. (1985).

Table 2 Average Composition of Milk and Milk Products (100 g)

Product	Fat (g)	Protein (g)	Lactose (g)	Total organic solids (g)
Skim milk	0.08	3.5	5.0	8.56
2% Milk	2.0	4.2	6.0	12.2
Whole milk	3.5	3.5	4.9	11.1
Half and half	11.7	3.2	4.6	19.5
Heavy cream	40.0	2.2	3.1	45.3
Chocolate milk	3.5	3.4	5.0	18.5
Churned buttermilk	0.3	3.0	4.6	8.0
Cultured buttermilk	0.1	3.6	4.3	10.0
Sour cream	18.0	3.0	3.6	24.6
Yogurt	3.0	3.5	4.0	10.8
Evaporated milk	8.0	7.0	9.7	27.0
Ice cream	10.0	4.5	6.8	41.3
Whey	0.3	0.9	4.9	6.3

Source: Harper and Blaisdell (1971).

oxygen consumed by a seeded, diluted wastewater sample incubated at 20°C for 5 days (American Public Health Association, 1992). One gram of milk fat has a BOD of 0.89 g, whereas milk protein, lactose, and lactic acid have BOD values of 1.03, 0.65, and 0.63 g, respectively. The range of BOD values for various milks and milk products is given in Table 3. Roughly, 1 kg of BOD in dairy wastewater represents 9 kg of whole milk. Chemical oxygen demand (COD) is the amount of oxygen necessary to oxidize the organic carbon completely to CO₂, H₂O, and ammonia. The COD is measured colorimetrically after refluxing a sample of wastewater in a mixture of chromic and sulfuric acid (American Public Health Association, 1992). If the BOD/COD ratio of wastewater is less than 0.5, then the organic solids in the waste are not easily biodegraded. The BOD/COD ratio for dairy wastes has been reported to range from 0.50 to 0.78 (Brown and Pico, 1979; Danalewich et al., 1998; Harper et al., 1985; Marshall, 1978).

Some minor constituents, such as phosphorus and chloride, are also very important in the treatment of dairy wastes. Phosphorus is the element that limits plant and algal growth in surface waters. Discharge of any significant levels of phosphorus in waste effluents to surface waters can lead to decreased water quality in lakes and streams. Milk and milk by-products can contribute significant quantities of phosphorus to dairy wastes. The phosphorus content of milk is approximately 1000 mg/L, whereas whey contains 450 to 575 mg/L (Wendorff, 1991; Wendorff and Matzke, 1993). Salty whey and brines can contribute significant levels of chloride to dairy wastewater. Chloride concentrations in excess of 400 mg/L in effluents discharged to streams can result in chronic toxicity to

Table 3 Reported BOD₅ Values and Percentage Contribution of Milk Components to Product BOD₅

Product	BOD ₅ (mg/L)	% Contribution to BOD ₅ by		
		Milkfat	Milk Protein	Lactose
Skim milk	67,000	6.3	49.3	44.5
Whole milk	104,000	17.8	43.3	39.0
Half and half	156,000	62.4	19.7	17.9
Heavy cream	399,000	89.2	5.7	5.0
Churned buttermilk	68,000	4.2	48.2	46.7
Evaporated milk	208,000	34.6	35.0	30.6
Ice cream	292,000	30.7	15.9	15.2
Whey	34,000	5.9	20.6	70.8

Source: Harper and Blaisdell (1971).

sensitive water insects such as *Daphnia magna*. Because chloride cannot be removed with biological or chemical treatments, waste minimization is the only method for reducing chloride in dairy wastes (Wendorff, 1995).

III. TREATMENT OF MILK WASTE

Wastes from processing milk products are almost entirely composed of organic material in solution or colloidal suspension, although some larger suspended solids may be present in wastewater from cheese or casein manufacturing plants. Sand and other foreign material is present in limited amounts as a result of floor or truck washes. Because milk waste contains very little suspended matter, preliminary settling of solids does not result in any appreciable reduction of BOD. However, a screen and grit chamber with 0.95-cm mesh wire screen is recommended to remove large particles to prevent clogging of pipes and pumps in the treatment system. This is especially important if the waste is to be pumped with high-pressure pumps, as in spray irrigation. After preliminary treatment in the screen and grit chamber, the waste should be pumped to an equalization tank. With wide variations in wastewater flow, strength, temperature, and pH, some reaction time is required to allow neutralization of acid and alkaline cleaning compounds and to allow for complete reaction of residual oxidants from cleaning solutions with organic solids of dairy waste. Ideally, a minimum of 6–12 h of equalization should be provided to allow for waste stabilization. The equilibrated waste can then be treated with one of the following systems or a combination of treatment systems: (a) land application, (b) treatment ponds or lagoons, (c) activated sludge, (d) biological filtration, or (e) anaerobic digestion.

A. Land Application

Because many dairy plants are located in rural areas, land application of process wastewater and waste by-products may be the simplest and most economical means of treating dairy wastes. Wastewater may be applied in a ridge and furrow system or by spray irrigation. Pollutants in the dairy wastewater are removed by a combination of physical and biological processes. The soil serves as an effective filter to physically remove particulate and colloidal material from process wastes. The upper 12–15 cm of soil can remove as much as 30–40% of the BOD and COD (Law et al., 1969).

Soluble organic compounds in dairy wastewater and particulate material filtered by the soil are degraded by heterotrophic microorganisms in soil. Table 4 lists the range of numbers for major groups of microorganisms in a fertile agricultural soil of midwest United States. Major genera of bacteria in soils include *Arthrobacter*, *Bacillus*, *Achromobacter*, *Flavobacterium*, and *Pseudomo-*

Table 4 Relative Number of Soil Flora and Fauna Commonly Found in Surface Soils^a

Organisms	Number	
	per m ³	per gram
Microflora		
Bacteria	10 ¹³ –10 ¹⁴	10 ⁸ –10 ⁹
Actinomycetes	10 ¹² –10 ¹³	10 ⁷ –10 ⁸
Fungi	10 ¹⁰ –10 ¹¹	10 ⁵ –10 ⁶
Algae	10 ⁹ –10 ¹⁰	10 ⁴ –10 ⁵
Microfauna		
Protozoa	10 ⁹ –10 ¹⁰	10 ⁴ –10 ⁵
Nematoda	10 ⁶ –10 ⁷	10–10 ²
Other fauna	10 ³ –10 ⁵	
Earthworms	30–300	

^a Generally considered 15 cm deep, but in some instances (e.g., earthworms), a greater depth is used.

Source: Brady (1990).

nas (Goodfellow, 1968). Soil microorganisms are contained within biofilms absorbed to colloids or soil particles (Metting, 1993).

1. Biochemical Oxygen Demand Removal

Under aerobic conditions, soil microorganisms degrade the organic pollutants completely to CO₂ and BOD removal should be more than 99%. If the concentration of BOD or the volume of wastewater is too great for the soil capacity, anaerobic conditions may result. Spyridakis and Welch (1976) reported that anaerobic conditions in the soil surface result in a low rate of biological activity and, thus, a tendency for sludge accumulation, production of ferrous sulfide, or accumulation of polysaccharides. Allison (1947) demonstrated that soil clogging was a result of biochemical activity by microorganisms within soil and not the result of filling soil spaces with sludge from wastewater. Lactose and milk proteins are easily decomposed by anaerobic soil bacteria. However, fats and oils are more resistant to decomposition and tend to accumulate in soil under anaerobic conditions. By providing periods of rest between applications to allow soil to dry, clogging problems disappear and aerobic conditions return to the soil surface. Treatability of a large volume of low BOD waste may be limited by the percolation capacity of soil, whereas a small volume of waste with high BOD is more apt to be limited by the oxidative capacity of microorganisms and sorptive capacity of organic matter in soil (Spyridakis and Welch, 1976).

Parkin and Marshall (1976) reported application rates for dairy plant wastewater of 130 m³/ha to 1500 m³/ha (1 hectare = 2.49 acres) on New Zealand pasture land. A rest period of 10–60 days was used to allow soil bacteria to decompose the effluent and soil to dry out. Guichet et al. (1991) reported application rates of 45 mm of liquid per month for wastewater sludge from a butter and cheese processing plant in France. They observed rapid decomposition of lactose in sludge, but reported a gradual accumulation of lipids in treated soil. A regular application of dairy wastewater sludge to soil for 25 years resulted in a twofold increase in the level of organic matter in soil. The additional moisture and added buffering of pH from dairy waste greatly improved mineralization of organic matter in soil (Guichet et al., 1991).

2. Nitrogen and Phosphorus Removal

Nitrogen from dairy wastes is removed by sedimentation of protein absorbed to soil and volatilization of ammonia, uptake by crops, and biological denitrification (Lance, 1972). Milk proteins may be degraded by proteolytic soil bacteria or microflora present in milk waste from the dairy plant. Ammonia from protein breakdown is biologically oxidized to nitrate by a process known as nitrification.

Nitrification is a two-step process whereby ammonia is first converted to nitrite and then to nitrate. Conversion of ammonia to nitrite is accomplished by *Nitrosomonas* sp., whereas conversion of nitrite to nitrate is completed by *Nitrobacter* sp. Nitrification can also be brought about by certain heterotrophs, including fungi such as *Aspergillus flavus*, some species of *Penicillium*, and bacteria (e.g., *Arthrobacter*) (Hattori, 1973). Other heterotrophic bacteria, such as *Achromobacter*, *Corynebacterium*, *Agrobacterium*, and *Alcaligenes*, can convert ammonia to nitrite. Nitrification requires aerobic conditions, because gaseous oxygen is involved in the reaction. Nitrification of ammonia releases hydrogen ions, resulting in acidification of the soil.

Nitrogen uptake by plants generally does not exceed 60–70% of added inorganic fertilizers. Only with careful management of organic nitrogen sources, such as milk proteins, can increased nitrogen uptake by crops be experienced. The remaining nitrate in soil may be lost by leaching to groundwater or by biological denitrification. Denitrification occurs when nitrate is reduced to nitrogen gas under anaerobic conditions in soil. Doran et al. (1985) reported that 66–69% of nitrogen in dairy wastes was lost through denitrification in ridge and furrow systems.

Phosphorus in dairy wastes is removed by adsorption to soil particles, chemical precipitation, and uptake by crops. Generally, phosphorus is effectively removed in the upper 0.3–0.6 m of soil (Spyridakis and Welch, 1976). Soils have very reactive surfaces containing iron, aluminum, and calcium, which readily form insoluble phosphates. Normally, the content of organic phosphorus in a

soil is higher than that of inorganic phosphorus. Mineralization of phosphorus in organic matter results through action of bacteria, actinomycetes, and fungi. Up to 50% of phosphorus from organic fertilizers can be effectively removed by crops (Fried and Broeshart, 1967).

High-strength dairy wastes such as whey, whey permeate, and antibiotic-contaminated milk can effectively be used as sources of plant nutrients for agricultural crops (Kelling and Peterson, 1981; Peterson et al., 1979; Wendorff, 1989). Sharratt et al. (1962) pointed out that nitrification of organic nitrogen from whey proteins was controlled by the carbon to nitrogen (C:N) ratio of whey. If the C:N ratio of whey is too great, nitrogen is incorporated into cells of microbes and so is unavailable to plants for some time. Conversely, if the C:N ratio is small, microbes, through nitrification, convert much of the nitrogen in whey to nitrate within several weeks. Nitrate determinations on soil receiving whey indicated that organic nitrogen in whey was readily converted to nitrates during the first and second seasons after application. Sharratt et al. (1959) reported increased growth of bluegrass the second year after application of whey. They credited this extra production to slow breakdown of nitrogen compounds in whey. Whey and whey permeate also contain high concentrations of phosphorus, which can be used for plant growth (Peterson et al., 1979; Wendorff and Matzke, 1993). Most phosphorus in whey is inorganic phosphorus, which is readily available for plant uptake.

High levels of soluble salts in whey and whey permeate may limit application rates to certain soils and crops. Some salt-sensitive crops such as soybeans, green beans, and red clover are susceptible to leaf burn and application rates should not exceed 13 mm/yr (Kelling and Peterson, 1981). Chloride levels in whey greatly exceed the drinking water standard of 250 mg/L, and application rates should be restricted to no more than 26,000 L/ha/yr to avoid leaching of significant levels of chloride to groundwater (Matzke and Wendorff, 1993; Wendorff, 1993).

3. Removal of Microorganisms

Unlike domestic wastewater, dairy plant wastewater and dairy wastes do not contain significant levels of human pathogens that may be of concern when irrigating processed food crops. Extensive field observations indicate that bacteria and viruses are efficiently removed from wastewater as it percolates through soil. Removal of bacteria by soils is inversely proportional to the particle size of soils. Viruses may be transported to greater depths in soil than bacteria because of their smaller size (Drewry and Eliassen, 1968). However, percolation through even the coarsest soil will remove bacteria and viruses within 1–2 m (McGauhey, 1968). The potential leaching of bacteria or viruses from sludge or wastewater to groundwater is minimal (Bitton, 1994).

B. Treatment Ponds or Lagoons

Dairy plants in rural areas with insufficient farmland available for land application may be able to use ponds or lagoons for economical treatment of dairy wastes. A pond or lagoon normally consists of a shallow basin designed for treatment of dairy wastewater without extensive equipment and controls. The three types of ponds used are aerobic, facultative, and anaerobic.

1. Aerobic Ponds

Aerobic ponds are generally 0.5–2.0 m deep, and contents are mechanically mixed and aerated to allow penetration of sunlight necessary for growth of algae. The algae produce oxygen through photosynthesis and use waste products from the bacteria involved in the biological breakdown of milk wastes. At 20°C, a BOD removal of 85% can be experienced with an aeration period of 5 days (Bitton, 1994). Pickett (1988) reports retention times of up to 90 days for wastewater from a cheese plant.

2. Facultative Ponds

Facultative ponds are the most common type of treatment ponds for high-strength dairy wastes. Treatment is achieved by action of aerobic, anaerobic, and facultative microorganisms as outlined in Fig. 1. In the upper zone, oxygen is supplied by photosynthetic green and blue-green algae. The algae also take up some of the nitrogen and phosphorus from dairy wastes. In the aerobic zone, heterotrophic

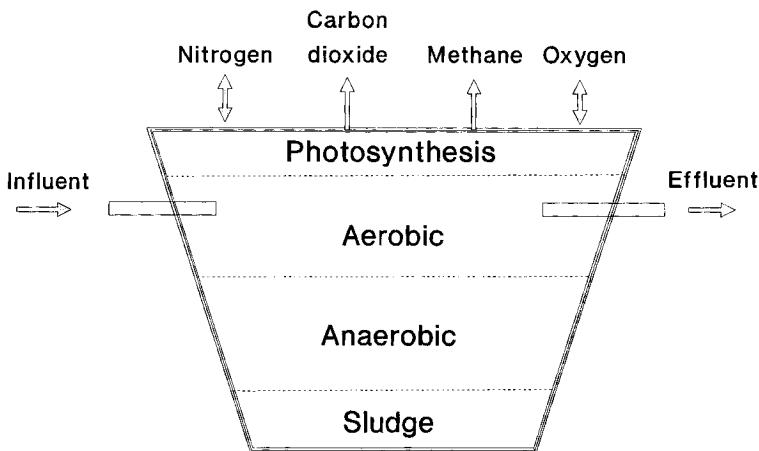

Figure 1 Microbial activities in a waste treatment pond.

bacteria degrade organic matter in dairy wastes and produce CO_2 and micronutrients needed by algae. Some of the typical bacteria involved in this process include genera such as *Pseudomonas*, *Achromobacter*, and *Flavobacterium* (Sterritt and Lester, 1988). Dead bacteria and algae settle to the bottom of the pond and are degraded by anaerobic microorganisms. During anaerobic decomposition, methane, hydrogen sulfide, carbon dioxide, and nitrogen may be released to the atmosphere. Although some carbon is lost with escape of CO_2 or CH_4 , most of it is converted to microbial biomass. Zooplankton (rotifera, cladocera, and copepoda) feed on bacterial and algal cells (Bitton, 1994). However, unless sludge is periodically removed from the base of the pond, little carbon reduction is obtained with facultative ponds. BOD removals of up to 90% can be obtained in facultative ponds depending on climatic conditions. Although the aerobic phase of treatment is fairly tolerant of temperature variations, the anaerobic phase is very sensitive, with activity almost ceasing at or below 17°C (Sterritt and Lester, 1988). Retention time in facultative ponds ranges from 5 to 30 days.

3. Anaerobic Ponds

Anaerobic ponds are generally used to pretreat dairy wastes with high protein and fat levels or for stabilizing settled solids. Organic matter is biodegraded and gases such as CH_4 , CO_2 , and H_2S are produced. To reduce effectively the BOD in anaerobic effluent, an aerobic process must follow to allow aerobic microorganisms to use up the residual breakdown products. The typical retention time for anaerobic treatment ponds ranges from 20 to 50 days (Metcalf and Eddy, Inc., 1991).

C. Activated Sludge

Activated sludge is one of the most popular methods for treating dairy wastes. The process consists of aerobic oxidation of organic matter to CO_2 , H_2O , NH_3 , and cell biomass followed by sedimentation of activated sludge. A portion of the activated sludge is returned to the aeration tank to continue the treatment cycle (Fig. 2).

1. Activated Sludge Microorganisms

Activated sludge contains a large mass of various microorganisms plus organic and inorganic particles. The concentration of biomass in the aeration or contact tank is normally called the mixed liquor suspended solids (MLSS). Bacteria make up the largest portion of activated sludge in the aeration process. Bitton (1994) noted that more than 300 strains of bacteria thrive in activated sludge. Bacteria are primarily responsible for oxidation of organic matter and formation of polysaccharides and other polymeric materials that aid in flocculation of the microbial

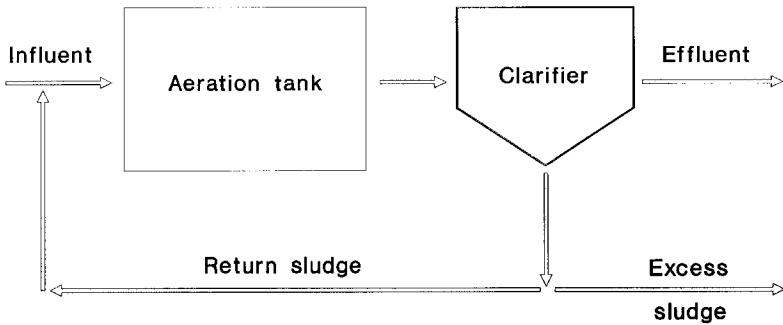

Figure 2 The conventional activated sludge treatment system.

biomass. Table 5 lists some bacterial genera found in activated sludge. Estimates of aerobic bacterial counts in activated sludge are approximately 10^{10} /g of MLSS or 10^7 – 10^8 /mL (Sterritt and Lester, 1988). Hanel (1988) stated that the active fraction of bacteria in activated sludge flocs represents only 1%–3% of total bacteria present. This indicates that the major portion of activated sludge is actually dead cells and extracellular material. Activated sludge does not normally favor growth of yeast, algae, or fungi.

Protozoa may represent up to 5% of the MLSS. Protozoa are predators of bacteria in activated sludge; they help reduce effluent suspended solids and soluble BOD. Sterritt and Lester (1988) estimated approximately 5×10^4 protozoa in typical activated sludge. Most protozoa present in activated sludge are ciliates,

Table 5 Bacterial Genera Found in Activated Sludge

Major genera	Minor genera
<i>Zoogloea</i>	<i>Aeromonas</i>
<i>Pseudomonas</i>	<i>Aerobacter</i>
<i>Comomonas</i>	<i>Micrococcus</i>
<i>Flavobacterium</i>	<i>Spirillum</i>
<i>Alcaligenes</i>	<i>Acinetobacter</i>
<i>Brevibacterium</i>	<i>Gluconobacter</i>
<i>Bacillus</i>	<i>Cytophaga</i>
<i>Achromobacter</i>	<i>Hyphomicrobium</i>
<i>Corynebacterium</i>	
<i>Sphaerotilus</i>	

Source: Sterritt and Lester (1988).

although ameba and flagellates may also be present under certain conditions. The predominant genera of ciliates in activated sludge are *Opercularia*, *Vorticella*, *Aspidisca*, *Carchesium*, and *Chilodonella*. Protozoa are also responsible for a significant reduction of pathogenic bacteria and viruses in activated sludge. Reductions of *Escherichia coli*, and coxsackievirus, and poliovirus in excess of 90% have been reported (Sterritt and Lester, 1988).

Rotifers are multicellular organisms that are present in aging activated sludge. Their role includes removal of freely suspended bacteria and aiding in floc formation by producing fecal pellets surrounded by mucus (Curds and Hawkes, 1975). The four most common genera of rotifers present in activated sludge include *Philodina*, *Habrotrocha*, *Notommata*, and *Lecane*.

2. Conventional Process

In the conventional activated sludge process, dairy wastewater is introduced into the aeration tank along with a portion of activated sludge from the clarifier. Air is incorporated into the waste mixture with diffusers or mechanical aerators. The air serves two purposes in the aeration tank: first, to supply oxygen to aerobic microorganisms and, second, to keep the activated sludge floc thoroughly mixed with incoming wastewater to allow maximal efficiency in oxidation of organic matter. Key parameters controlling operation of the activated sludge process are rate of (a) aeration in the tank, (b) return of activated sludge to the aeration tank, and (c) waste or excess sludge discharged from the treatment system. Normal detention time for conventional activated sludge treatment of municipal or low-strength wastewater is 4–8 h (Bitton, 1994). However, dairy wastewaters may require longer detention times, 15–40 h, to reduce BODs to an acceptable level (Jones, 1974). This type of process is called an extended aeration system. Jones (1974) reported that BOD removal efficiencies in excess of 90% are attainable for dairy wastewaters with extended aeration treatment. Bangsbo-Hansen (1978) also reported that effluent standards of 20 mg of BOD/L could be met if BOD of incoming dairy wastewater was between 700 and 1200 mg/L. Orhon et al. (1993) indicated that effluent COD cannot be biologically reduced below 85 mg/L, regardless of sludge age, due to generation of residual fractions.

3. Contact Stabilization Process

Another modification of the activated sludge treatment is a three-step process known as the contact stabilization process (Fig. 3). This process allows for a 30-min detention time in the contact tank in which microorganisms obtain their food. Sludge containing the organisms and their food is separated in the clarifier. Sludge that is to be returned to the contact tank is first sent to an aerated stabilization tank for 4–8 h during which time microorganisms finish digesting their food. By aerating only sludge that is being returned to the initial contact tank, less tank

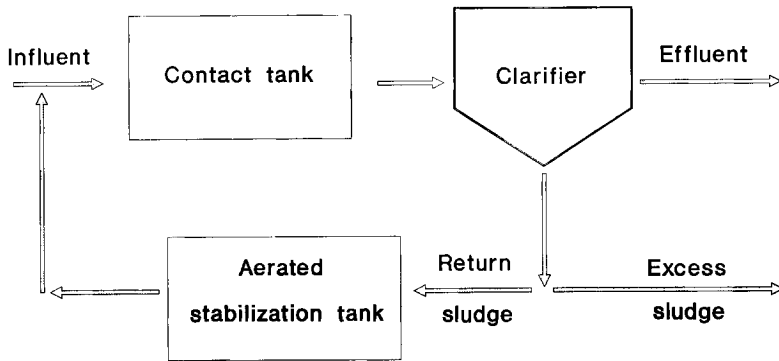

Figure 3 Activated sludge system with contact stabilization.

space and less air are required. This system produces less sludge and is better suited for shock loading. Fang (1991) reported that BOD of dairy wastewater could be reduced by 99% and total Kjeldahl nitrogen by 91% after a total detention time of 19.8 h in this type of system.

4. Sequencing Batch Reactor Process

The most popular activated sludge treatment uses sequencing batch reactors (SBRs). As shown in Fig. 4, the SBR process is a single-tank fill-and-draw system that provides for activated sludge aeration, settling, effluent withdrawal, and sludge recycling. Usually, a plant has two or more SBR tanks; thus allowing for the filling of one tank while the other is going through the reaction sequence. Once the tank is filled, wastewater is mixed, without aeration, to allow uptake of soluble fermentation products. The aeration step provides for oxidation of organic matter in wastewater. Activated sludge is then settled and treated effluent is drawn off to complete the cycle. This process normally operates over longer detention times than conventional activated sludge systems and allows for wide variations in strength of waste. Schulte (1988) reported that elimination of clarifiers and sludge pump stations, along with flexibility and adaptability to automated process control, made the SBR process more cost effective on creamery wastewater than other activated sludge processes. COD removals of 91–97% and sludge with good settling properties were obtained from dairy wastes treated in a SBR with a cycle time of 24 h (Eroglu et al., 1992).

5. Nitrogen and Phosphorus Removal

In removing nitrogen from dairy wastewater with activated sludge processes, nitrogen must first be removed by nitrification (see Sec. III.A.2) followed by

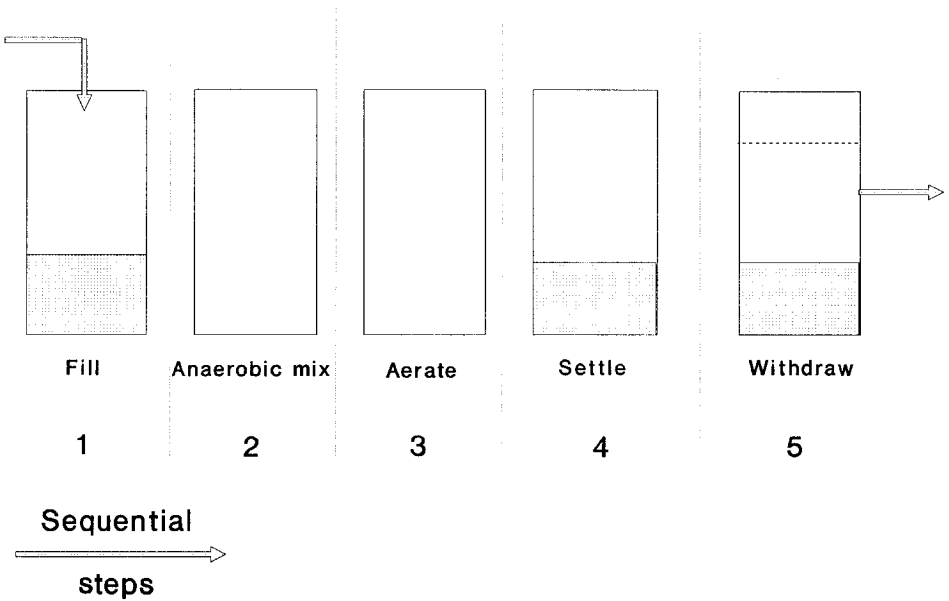

Figure 4 Treatment steps using a Sequencing Batch Reactor (SBR).

denitrification. Growth of *Nitrosomonas* and *Nitrobacter* sp. in activated sludge depends on BOD of mixed liquor and retention time of sludge. The growth rate of nitrifiers is slower than that of heterotrophs in activated sludge, so an aged sludge is needed for conversion of ammonia to nitrate. Hawkes (1983) reports that nitrification is expected at a sludge age of more than 4 days. Nitrification proceeds well in a two-stage activated sludge system in which BOD is removed in the first stage and nitrifiers complete nitrification in the second stage (U.S. Environmental Protection Agency, 1977). To remove nitrate from waste effluent, denitrification must occur under anaerobic or anoxic conditions before treated effluent is discharged to surface waters. This can be accomplished by using a three-stage activated sludge system in which BOD reduction takes place in the first, nitrification in the second, and denitrification in the third stage. An ideal environment for denitrification is provided by the absence of dissolved oxygen and the presence of a readily degradable organic substrate (Kolarski and Nyhuis, 1995). Methanol or settled sewage serves as carbon source for denitrifiers (Curds and Hawkes, 1983).

Phosphorus removal in activated sludge systems usually requires a combination of anaerobic and aerobic stages in the process. Facultative organisms in the initial anaerobic zone produce acetate and fermentation products from soluble

BOD of the waste. Microorganisms able to remove high levels of phosphorus use these fermentation products and store them with the aid of energy from hydrolysis of stored polyphosphates during the anaerobic period. During the aerobic stage of the process, stored products are depleted and soluble phosphorus is taken up, with excess amounts being stored as polyphosphates (Buchan, 1981). Fuhs and Chen (1975) identified bacteria of the *Acinetobacter* genus as high-phosphorus–storing microbes active in activated sludge systems. The high-phosphorus–containing sludge must be completely removed from effluent to ensure compliance with effluent phosphorus limitations. In some instances, alum or ferric chloride may be added to effluent before the secondary clarifier to remove additional soluble phosphorus before final discharge of treated effluent (U.S. Environmental Protection Agency, 1987).

6. Flocculation

Settling of sludge in the clarifier usually proceeds best when the microbial growth rate is slow and nutrient concentrations are very low. Extracellular polysaccharides and slimes produced by *Zoogloea ramigera* and other activated sludge organisms play a leading role in bacterial flocculation and floc formation (Norberg and Enfors, 1982). Good sludge settling and BOD removal occurs at high MLSS concentrations. Microbial flocculation can be enhanced with addition of polyelectrolytes, alum, or iron salts as coagulants (Bitton, 1994).

Poor settling of sludges may be observed if excess production of exopolysaccharides by bacteria occurs in activated sludge. This nonfilamentous bulking may be corrected with chlorination (Chudoba, 1989). Filamentous bulking may be caused by excessive growth of filamentous bacteria such as *Sphaerotilus* sp. (Sterritt and Lester, 1988) or *Nostocoida limicola* (Goronszy, 1990). A low level of dissolved oxygen in the aeration tank is the primary factor contributing to growth of this filamentous bacterium in activated sludge (Lau et al., 1984; Martin and Zall, 1985).

D. Biological Filtration

1. Trickling Filter

Biological filters, such as trickling or percolating filters, are one of the earliest types of biological waste treatment. In a biological filter, the biofilm is attached to a support substance such as gravel, stones, or plastic materials. As wastewater is pumped over the biofilm, it oxidizes organic matter and removes nutrients such as nitrogen and phosphorus.

A basic trickling filter is composed of a tank containing a filter medium to a depth of 1.0–2.5 m, a wastewater distributor that applies the waste solution evenly over the medium bed, and a final clarifying tank to remove sludge and

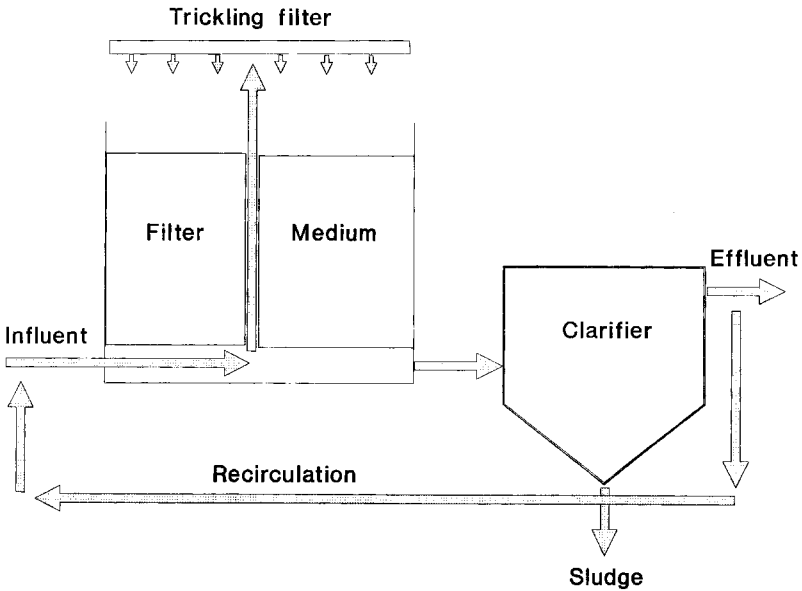

Figure 5 Trickling filter waste treatment system.

solids sloughing off the filter medium (Fig. 5). In some instances, wastewater is recirculated through the system to provide for added dissolved oxygen to primary influent and greater removal of BOD (U.S. Environmental Protection Agency, 1977). The two most important factors affecting microbial growth on the support medium are flow rate of wastewater and size and geometrical configuration of support material. In the initial startup of the filter, the medium surface is colonized by gram-negative bacteria followed by filamentous bacteria. The biofilm formed on support material is called a zooglear film and is composed of bacteria, fungi, algae, protozoa, and other life forms such as rotifers, nematodes, snails, and insect larvae (Bitton, 1994). Some of the bacterial genera active in trickling filters are *Flavobacterium*, *Pseudomonas*, *Achromobacter*, and filamentous bacteria such as *Sphaerotilus* (Sterritt and Lester, 1988). Growth conditions on the outer surface of the biofilm are aerobic but the inner portion of the biofilm next to support material tends to be anaerobic.

Trickling filters are categorized by the loading rate to the filter medium. Low-rate trickling filters (<40 kg BOD/100 m³/day) allow for nitrification and more complete removal of nutrients from wastewater. High-rate filters (60–160 kg BOD/100 m³/day) rarely have nitrification take place and have lower treatment efficiencies (U.S. Environmental Protection Agency, 1975). BOD removal

by trickling filters is approximately 85% for low-rate filters and 65–75% for high-rate filters (U.S. Environmental Protection Agency, 1977).

2. Rotating Biological Contactor

One biofilm reactor that operates much as the trickling filter is the rotating biological contactor (RBC). The RBC unit consists of a horizontal shaft with disks of medium that are rotated through primary effluent. Because only about 40% of the medium is submerged, the biofilm growing on the medium obtains its food from effluent and oxygen from air above the solution. Increased rotation of disks improves oxygen transfer and enhances contact between biofilm and wastewater (March et al., 1981). The biofilm on RBC is composed of a diverse mixture of eubacteria, filamentous bacteria, protozoa, and metazoa. Alleman et al. (1982) identified *Beggiatoa* spp. as primary bacteria in the outer aerobic layer of the biofilm and *Desulfovibrio*, a sulfate-reducing bacterium, in the inner anaerobic layer. Advantages of the RBC are shorter treatment times, lower cost of operation, and production of a readily dewatered sludge that settles easily (Weng and Molof, 1974). For high-strength dairy wastes, Surampalli and Baumann (1992) reported that the first section of the RBC must be enlarged to provide sufficient dissolved oxygen for adequate reduction of BOD. For effective nitrification, the second stage of the RBC must have an increased rotational speed to promote growth of nitrifying bacteria. Using a moving bed biofilm reactor, Rusten et al. (1992) showed a 85% COD removal from dairy wastewater at an organic loading rate of 500 g COD/m³h.

E. Anaerobic Digestion

Anaerobic digestion has been used to stabilize waste treatment sludges for many years. However, in recent years, it has also been designed to treat high-strength dairy wastes. In anaerobic breakdown of dairy wastewater, lactose is first fermented to lactic acid and fats and proteins are hydrolyzed to organic acids, amino acids, aldehydes, and alcohols. Second, the intermediate organic compounds are converted to methane and CO₂. Because anaerobic digestion does not require oxygen for decomposition of organic material, operating costs for treatment are greatly reduced from that of aerobic treatments. However, it is a much slower treatment process that is more susceptible to toxic upsets (Bitton, 1994).

1. Conventional Process

A typical anaerobic digester is shown in Fig. 6. The anaerobic digester is a large fermentation tank in which fermentation, sludge settling, sludge digestion, and gas collection take place simultaneously. Many dairy plants use a two-stage system in which the first stage is complete mixing of the contents of a fermentation

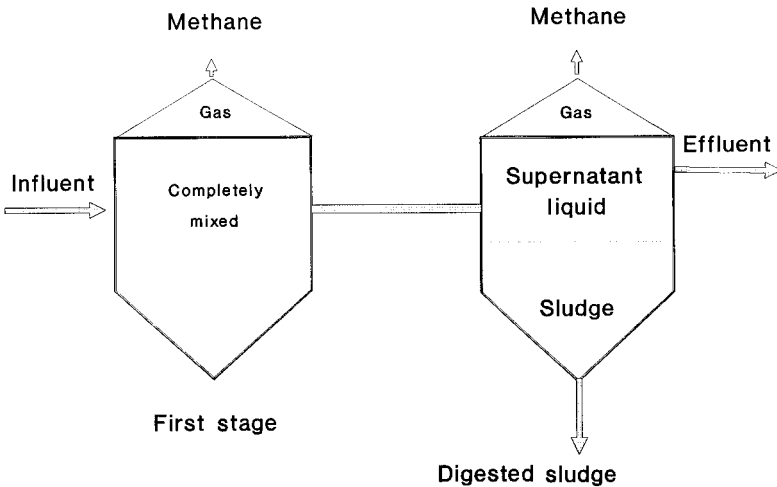

Figure 6 Two-stage anaerobic digester for dairy wastewater.

tank and the second stage is a digester in which the contents are allowed to stratify. The two-stage anaerobic process allows for higher loading rates and shorter hydraulic retention times (Ghosh et al., 1985). In anaerobic treatment of wastewater, fermentation of sugars, amino acids, and fatty acids is primarily carried out by strict and facultative anaerobic bacteria such as *Bacteroides*, *Bifidobacterium*, *Clostridium*, *Lactobacillus*, and *Streptococcus* (Sterritt and Lester 1988). Production of methane from fermentation intermediate compounds is accomplished by methanogenic bacteria, which are strict anaerobes. Approximately two-thirds of the methane is derived from acetate conversion by acetotrophic methanogens and the other one-third is the result of carbon dioxide reduction by hydrogen (Mackie and Bryant, 1981). Methanogens are difficult to grow in pure culture, but Balch et al. (1979) developed a classification scheme for some species involved in this process. Perle et al. (1995) reported that milkfat was inhibitory to methanogenic bacteria, and dairy effluents should be treated by anaerobic digestion only after the milk fat concentration was less than 100 mg/L. They also indicated that anaerobic cultures at the startup of anaerobic digestion should be acclimatized to casein to ensure proper degradation of casein in the process. Methanogenic bacteria are also sensitive to acidic conditions with complete inhibition below pH 6 (Britton, 1994). With efficient operation of one- or two-stage anaerobic digesters, dairy plants should experience BOD reductions of 78–95% (Fang, 1991; Guiot et al., 1995). Biogas from the digester contains up to 67–75% methane (Eroglu et al., 1992; Lebrato et al., 1990).

2. Upflow Anaerobic Filter

Upflow anaerobic filters operate much like trickling filters, but growth conditions for microbes are anaerobic. The primary effluent is pumped into the base of the reactor containing a support medium for growth of the biofilm. Upward flow of wastewater keeps suspended solids in solution. In some instances, support material is replaced with sand to form a fluidized-bed reactor. This type of reactor is effective for low-strength wastes (COD of <600 mg/L) (Speece, 1983). Anderson et al. (1994) indicated that, to obtain high organic loading rates on anaerobic upflow filters, a porous medium must be used in the column to allow for sufficient biomass development. Temperature of effluent is important for proper fermentation and production of biogas. Viraraghavan and Kikkeri (1990) reported average COD removals in three anaerobic filters were 92, 85, and 78% at 30, 21, and 12°C, respectively. The volume of biogas generated was lower at lower temperatures but the percentage of methane in biogas was higher at lower temperatures. Under efficient operation, anaerobic filters reduce dairy wastewater BODs by 90–97% and produce biogas with 54–75% methane (Kaiser and Dague, 1994; Sammaiah et al., 1991). Backman et al. (1985) identified the three steps in anaerobic digestion of dairy wastes as liquefaction, acid formation, and methane formation. They reported the limiting step at lower organic loadings was the acid formation step, whereas at higher organic loadings, limiting steps were liquefaction and acid formation.

3. Upflow Anaerobic Sludge Blanket

The upflow anaerobic sludge blanket (USAB) digester consists of a tank with a bottom layer of packed sludge, a sludge blanket, and an upper liquid layer. Wastewater flows up through the sludge blanket of active biomass. Settler screens separate sludge from treated effluent and biogas is collected at the top of the digester (Lettinga et al., 1980). Granular sludge aggregates that form contain three layers of bacteria (MacLeod et al., 1990). The inner layer contains *Methanothrix*-like cells that act as nucleation centers. The middle layer contains bacterial rods that include both H₂-producing acetogens and H₂-consuming organisms. The outermost layer contains a mixture of fermentative and H₂-producing bacteria. Dairy wastes function well in the UASB process, because granulation of sludge is favored by soluble carbohydrates (Wu et al., 1987). Kato et al. (1994) reported that for dairy wastes with a COD below 2000 mg/L, acidification instead of methanogenesis was the rate-limiting step in COD reduction. However, Elliott et al. (1991) found that when treating a high-strength waste such as whey permeate, the rate of acid production was too rapid and acetate and propionate accumulated to concentrations that were inhibitory to methanogenic bacteria. Rico-Gutierrez et al. (1991) indicated that some addition of alkali may be necessary in the startup of the reactor to maintain buffering capacity until a mature

bacterial population is established and methanogenesis is proceeding in a uniform manner. COD removal efficiencies of 60–97% were achieved at organic loading rates of 7–30 kg COD/m³/day (Ozturk et al., 1993; Samson et al., 1984).

IV. TREATED DAIRY EFFLUENTS

Effluents from waste treatment systems must be sufficiently reduced in BOD and biological nutrients (e.g., P, NH₃) that discharge to surface waters does not significantly affect aquatic life. Environmental regulatory agencies specify limits for composition of effluents discharged to each type of stream or watershed. To reduce the volume of dairy wastewater to be treated and reduce treatment costs, careful attention must be given to minimizing losses of milk and milk products in the dairy plant. With good product conservation and selection of an effective waste treatment process, dairy plant operators should be able to operate profitably and meet environmental requirements.

REFERENCES

- Alleman JE, Veil JA, Canaday JT. Scanning electron microscope evaluation of rotating biological contactor biofilm. *Water Res* 16:543, 1982.
- Allison LW. Effect of microorganisms on permeability of soil under prolonged submergence. *Soil Sci* 63:439, 1947.
- American Public Health Association. In: Greenberg AE, Clesceri LS, Eaton AD, eds. *Standard Methods for the Examination of Water and Wastewater*. 18th ed. Washington, DC: American Public Health Association, 1992.
- Anderson GK, Kasapgil B, Ince O. Comparison of porous and non-porous media in upflow anaerobic filters when treating dairy wastewater. *Water Res* 28:1619, 1994.
- Backman RC, Blanc FC, O'Shaughnessy JC. The treatment of dairy wastewater by the anaerobic up-flow packed bed reactor. *Proceedings of 40th Purdue Industrial Waste Conference*, West Lafayette, IN, 1985, p 361.
- Balch WE, Fox GE, Magnum LJ, Woese CR, Wolfe RS. Methanogenesis: reevaluation of a unique biological group. *Microbiol Rev* 143:260, 1979.
- Bangsbo-Hansen D. Dairy wastewater. *Nordeuropaeisk-Mejeri-Tidsskrift* 44:101, 1978.
- Bitton G. *Wastewater Microbiology*. New York: Wiley, 1994.
- Brady NC. *The Nature and Properties of Soils*. New York: Macmillan, 1990.
- Brown HB, Pico RF. Characterization and treatment of dairy wastes in the municipal treatment system. *Proceedings of 34th Purdue Industrial Waste Conference*, West Lafayette, IN, 1979, p 326.
- Buchan L. The location and nature of accumulated phosphorus in seven sludges from activated sludge plants which exhibited enhanced phosphorus removal. *Water SA* 7:1, 1981.

- Carawan RE, Jones VA, Hansen AP. Wastewater characterization in a multiproduct dairy. *J Dairy Sci* 62:1243, 1979.
- Chudoba J. Activated sludge-bulking control. In: Cheremisinoff PN, ed. *Encyclopedia of Environmental Control Technology*. Vol. 3. *Wastewater Treatment Technology*. Houston, TX: Gulf Publishing, 1989, p 171.
- Curds CR, Hawkes HA. *Ecological Aspects of Used-Water Treatment*. Vol. 2. London: Academic Press, 1983.
- Danalewich JR, Papagiannis TG, Belyea RL, Tumbleson ME, Raskin L. Characterization of dairy waste streams, current treatment practices, and potential for biological nutrient removal. *Wat Res* 32:3555, 1998.
- Doran FJ, Sauer DK, Boyle WC, Berthouex PM. Nitrogen transformations and reduction by ridge and furrow land treatment of dairy waste. *Proceedings of 40th Purdue Industrial Waste Conference*, West Lafayette, IN, 1985, p 405.
- Drewry WA, Eliassen R. Virus movement in ground water. *J Water Poll Control Fed* 40: R257, 1968.
- Elliott JM, Parkin KL, Johnson EA. Biomethanation of cheese whey permeate by anaerobic digestion using a sewage sludge inoculum. Final Res Report, Department of Food Science, Madison, WI: University of Wisconsin, 1991.
- Eroglu V, Ozturk I, Demir I, Akca L, Kadir A. Sequencing batch and hybrid anaerobic reactors treatment of dairy wastes. *Proceedings of 46th Purdue Industrial Waste Conference*, West Lafayette, IN, 1992, p 413.
- Fang HHP. Pretreatment of wastewater from a whey processing plant using activated sludge and anaerobic processes. *J Dairy Sci* 74:2015, 1991.
- Fried M, Broeshart H. *The Soil-Plant System*. New York: Academic Press, 1967.
- Fuhs GW, Chen M. Microbial basis for phosphate removal in the activated sludge process for the treatment of wastewater. *Microbiol Ecol* 2:119, 1975.
- Ghosh S, Ombregt JP, Pipyn P. Methane production from industrial wastes by two-phase anaerobic digestion. *Water Res* 19:1083, 1985.
- Goodfellow M. Properties and composition of the bacterial flora of a pine forest soil. *J Soil Sci* 19:154, 1968.
- Goronszy MC. Batch reactor treatment of dairy wastewaters: A case history. *Proceedings of 44th Purdue Industrial Waste Conference*, West Lafayette, IN, 1990, p 795.
- Guichet J, Jambu P, Dinel H. Changes in the organic matter of a Rendzina soil caused by wastewater sludge disposals from dairy processing plants. *Pedologie* 41:149, 1991.
- Guiot SR, Safi B, Frigon JC, Mercier P, Mulligan C, Tremblay R, Samson R. Performance of a full-scale novel multiplate anaerobic reactor treating cheese whey effluent. *Biotechnol Bioeng* 45:398, 1995.
- Hanel L. *Biological Treatment of Sewage by the Activated Sludge Process*, Chichester, UK: Ellis Horwood, 1988.
- Harper WJ, Blaisdell JL. *Proceedings of Second National Symposium on Food Processing Wastes*, *Water Pollution Control Res. Series 12060*. Doc NO EP 1.16:12060, pp 509–545. Washington, DC: Environmental Protection Agency, 1971.
- Harper WJ, Carawan RE. Approaches to minimizing water usage and wastes in dairy plants. *Int Dairy Fed Bull Doc* 104. Brussels, Belgium: International Dairy Federation, 1978, p 53.

- Harper WJ, Delaney RAM, Igbeka IA, Parkin ME, Schiffermiller WE, Ross TE, Williams RA. Strategies for water and waste reduction in dairy food plants. EPA/600/2-85/076. Washington, DC: Environmental Protection Agency, 1985.
- Hattori T. Microbial Life in the Soil. New York: Marcel Dekker, 1973.
- Jones HR. Pollution Control in the Dairy Industry. Park Ridge, NJ: Noyes Data Corp, 1974.
- Kaiser SK, Dague RR. The temperature-phased anaerobic biofilter process. Water Sci Technol 29:213, 1994.
- Kato MT, Field JA, Kleerebezem R, Lettinga G. Treatment of low strength soluble wastewaters in UASB reactors. J Ferment Bioeng 77:679, 1994.
- Kelling KA, Peterson AE. Using whey on agricultural land—a disposal alternative. UW Extension Bull A3098. Madison, WI: University of Wisconsin, 1981.
- Kolarski R, Nyhuis G. The use of sequencing batch reactor technology for the treatment of high-strength dairy processing waste. Proceedings of 50th Purdue Industrial Waste Conference, West Lafayette, IN, 1995, p 485.
- Lance JC. Nitrogen removal by soil mechanisms. Water Poll Control Fed 44:1352, 1972.
- Lau AO, Strom PF, Jenkins D. Growth kinetics of *Sphaerotilus natans* and a floc former in pure and dual continuous culture. J Water Pollut Control Fed 56:41, 1984.
- Law JP Jr, Thomas RE, Myers LH. Nutrient removal from cannery wastes by spray irrigation of grassland. FWPCA, 16080-11/69. Washington, DC: U.S. Department of the Interior, 1969.
- Lebrato J, Perez-Rodriguez JL, Maqueda C, Morillo E. Cheese factory wastewater treatment by anaerobic semicontinuous digestion. Resources Conserv Recycling 3:193, 1990.
- Lettinga G, van Velsen AFM, Hobma SW, de Zeeuw W, Klapwijk A. Use of upflow sludge blanket (USB) reactor concept for biological wastewater treatment, especially for anaerobic treatment. Biotechnol Bioeng 22:699, 1980.
- Mackie DM, Bryant MP. Metabolic activity of fatty acid-oxidizing bacteria and the contribution of acetate, propionate, butyrate and CO₂ to methanogenesis in cattle waste at 40 and 60°C. Appl Environ Microbiol 41:1363, 1981.
- MacLeod FA, Guiot SR, Costerton JW. Layered structure of bacterial aggregates in an upflow anaerobic sludge bed and filter reactor. Appl Environ Microbiol 56:1598, 1968.
- March D, Benefield L, Bennett E, Linstedt D, Hartman R. Coupled trickling filter-rotating biological contactor nitrification process. J Water Pollut Control Fed 53:1469, 1981.
- Marshall KR. The characteristics of effluents from New Zealand dairy factories. Int Dairy Fed Bull Doc 104. Brussels, Belgium: International Dairy Federation, 1978, p 123.
- Martin JH, Zall RR. Dairy processing wastewater bioaugmentation—an evaluation of effectiveness. Proceedings of 40th Purdue Industrial Waste Conference, West Lafayette, IN, 1985, p 413.
- Matzke S, Wendorff WL. Chloride in cheese manufacturing wastes to be landspread on agricultural land. Bioresource Technol 46:251, 1993.
- McGauhey PH. Manmade contamination hazards. Ground Water 6(3):10, 1968.
- Metcalf and Eddy, Inc. Wastewater Engineering: Treatment, Disposal and Reuse. New York: McGraw-Hill, 1991.

- Metting JB Jr. Structure and physiological ecology of soil microbial communities. In: Soil Microbial Ecology. New York: Marcel Dekker, 1993, p 3.
- Norberg AB, Enfors SO. Production of extracellular polysaccharide by *Zooglea ramigera*. Appl Environ Microbiol 44:1231, 1982.
- Orhon D, Gorgun E, Germirli F, Artan N. Biological treatability of dairy wastewaters. Water Res 27:625, 1993.
- Ozturk I, Eroglu V, Ubay G, Demir I. Hybrid upflow anaerobic sludge blanket reactor (HUASBR) treatment of dairy effluents. Water Sci Tech 28:77, 1993.
- Parkin MF, Marshall KR. Land disposal of dairy factory effluent by spray irrigation. Int Dairy Fed Bull Doc 104. Brussels, Belgium: International Dairy Federation, 1978, p 151.
- Perle M, Kimchie S, Shelef G. Some biochemical aspects of the anaerobic degradation of dairy wastewater. Water Res 29:1549, 1995.
- Pickett M. F&A Dairy Products finds efficient wastewater system. Dairy Field 171(5):26, 1988.
- Peterson AE, Walker WG, Watson KS. Effect of whey application on chemical properties of soils and crops. J Agric Food Chem 27:654, 1979.
- Rico-Gutierrez JL, Garcia-Encina PA, Fernandez-Polanco F. Anaerobic treatment of cheese-production wastewater using a UASB reactor. Bioresource Technol 37:271, 1991.
- Rusten B, Odegaard H, Lundar A. Treatment of dairy wastewater in a novel moving bed biofilm reactor. Water Sci Tech 26:703, 1992.
- Sammaiah P, Sastry CA, Murty DVS. Dairy wastewater treatment using an anaerobic contact filter. Indian J Environ Prot 11:418, 1991.
- Samson R, Van den Berg B, Peters R, Hade C. Dairy waste treatment using industrial-scale fixed-film and upflow sludge bed anaerobic digesters: Design and start-up experience. Proceedings of 39th Purdue Industrial Waste Conference, West Lafayette, IN, 1985, p 235.
- Schulte SR. SBR treatment of food process wastewater. Proceedings of 1988 Food Processing Waste Conference, Georgia Institute of Technology, Atlanta, GA, 1988.
- Sharratt WJ, Peterson AE, Calbert HE. Whey as a source of plant nutrients and its effect on the soil. J Dairy Sci 42:1126, 1959.
- Sharratt WJ, Peterson AE, Calbert HE. Effect of whey on soil and plant growth. Agron J 54:359, 1962.
- Speece RE. Anaerobic biotechnology for industrial waste treatment. Environ Sci Technol 17:416A, 1983.
- Spyridakis DE, Welch EB. Treatment processes and environmental impacts on waste effluent disposal on land. In: Sanks RL, Asano T, eds. Land Treatment and Disposal of Municipal and Industrial Wastewater. Ann Arbor, MI: Ann Arbor Science Publishers, 1976, p 45.
- Sterritt RM, Lester JN. Microbiology for Environmental and Public Health Engineers. London: E & FN Spon, 1988.
- Surampalli RY, Baumann ER. RBC kinetics in treating domestic and industrial dairy wastewater under low and high organic loading conditions. Water Pollut Res J Canada 27:665, 1992.

- U.S. Environmental Protection Agency. Process Design Manual for Nitrogen Control. Washington, DC: Office of Technology Transfer, 1975.
- U.S. Environmental Protection Agency. Wastewater Treatment Facilities for Sewered Small Communities. Report EPA/625/1-77/009, 1977.
- U.S. Environmental Protection Agency. Phosphorus Removal. Design Manual EPA/625/1-87/001, 1987.
- Viraraghavan T, Kikkeri SR. Effect of temperature on anaerobic filter treatment of dairy wastewater. *Water Sci Technol* 22:191, 1990.
- Wendorff WL. Landspreading whey permeate: watch the parameters. *UW Dairy Pipeline* 1(1):1, 1989.
- Wendorff WL. Phosphorus in dairy wastes—a real challenge. *UW Dairy Alert*, Nov. 15, 1991. Madison, WI: University of Wisconsin, 1991.
- Wendorff WL. Revised guidelines for landspreading whey and whey permeate. *UW Dairy Alert*, June 1, 1993. Madison, WI: University of Wisconsin, 1993.
- Wendorff WL. Managing chloride and phosphorus by minimizing wastes. *UW Dairy Pipeline* 7(4):1, 1995.
- Wendorff WL, Matzke S. Phosphorus in major varieties of whey produced in Wisconsin. *Dairy Food Environ Sanit* 13:166, 1993.
- Weng CN, Molof AH. Nitrification in the biological fixed film RBC. *J Water Pollut Control Fed* 46:1674, 1974.
- Wu W, Hu J, Gu X, Zhao Y, Zhang H. Cultivation of anaerobic granular sludge with aerobic activated sludge as seed. *Water Res* 21:789, 1987.

Index

- Abomasum, 4
- Acetobacter*, 101, 392
- Achromobacter*, 61, 67, 101, 357, 685, 687, 690, 696
- Acidaminococcus fermentans*, 34
- Acid-anionic surfactant sanitizers:
 - advantages, 575
 - affect starter cultures, 185
 - disadvantages, 575
 - properties, 575
- Acid degree value (ADV) test, 647
- Acid injury, lactic acid bacteria, 304, 310
- Acidophilus milk:
 - manufacture, 316
 - sweet, 317
 - therapeutic properties, 316
- Acinetobacter*, 61, 67, 360
- Actinomyces* spp., 66
- Activated sludge treatment of dairy wastes:
 - activated sludge microorganisms, 690
 - bacteria in, 691
 - contact stabilization process, 692–693
 - conventional process, 692
 - extended aeration system, 692
 - flocculation, 695
 - nitrogen and phosphorus removal, 693
- [Activated sludge treatment of dairy wastes]
 - parameters controlling operation, 692
 - protozoa, 691–692
 - rotifers, 692
 - sequencing batch reactor process, 693
- Activity of starter cultures, 190, 191
- Adjunct starter cultures, 191, 192, 355, 370
- Aerobic spore count, 66, 653, 671–672
- Aerococcus*, 243, 244
- Aeromonas*, 61, 67, 599
- Aeromonas hydrophila*:
 - dairy plants, 94
 - milk and milk products, 60
 - psychrotrophic, 60
- Aerosols, 62, 63
- Aflatoxin:
 - acute toxicity, 416
 - B₁, 6, 7, 414
 - B₂, 6, 7, 414
 - carcinogen, 416
 - dairy products, 417–418
 - description of, 414–415
 - detection methods, 415–416
 - excretion in milk, 417

- [Aflatoxin]
 - hazard component in HACCP, 599
 - M₁, 6, 7, 414
 - M₂, 6, 7
 - milk and products, 6
 - nuts, 104
 - prevention, 418
 - public health concern, 500
 - stability, 418
 - synthesis, 415
- Agrobacterium*, 687
- Air:
 - microbiological quality, 141
 - source of contaminants, 350
- Alcaligenes*, 61, 357, 358, 687
- Alcaligenes viscolactis*, 67
 - ropy milk, 646
 - ropy milk test, 647
- Alloiococcus*, 243
- Alternaria*, 101, 501
- Alveoli, 7
- American Dairy Products Institute, 85, 88, 620
- Anaerobic digestion to treat dairy wastes:
 - anaerobic bacteria, 698
 - conventional process, 697–698
 - methanogenic bacteria, 698
 - two-stage process, 698
 - upflow anaerobic filter, 699
 - upflow anaerobic sludge blanket, 699–700
- Anaerovibrio lipolytica*, 26
- Annatto:
 - cheese colorant, 378
 - pink defect, 378
- Antibiotics (*see also* Drug residues):
 - affect starter cultures, 184, 185
 - Bacillus stearothermophilus* test for, 184
 - hazard component in HACCP, 599
 - raw milk, 6, 351
- Anticarcinogenic activity:
 - probiotics, 332
 - yogurt, 332
- Arthrobacter*, 365, 685, 687
- Aspergillus*, 101, 374, 501
- Aspergillus flavus*, 6
 - aflatoxin production, 414, 500
 - nitrification, 687
- Apergillus nomius*, 6, 414, 500
- Aspergillus oryzae*, 394
- Aspergillus parasiticus*, 6, 414, 500
- Aspidisca*, 692
- Atopobium*, 243
- Baby Swiss Cheese
 - eyes, 362
 - starter cultures, 362
- Bacillus*, 61, 67, 85, 101, 106, 137, 138, 353, 652, 685
- Bacillus anthracis*:
 - causes anthrax, 419
 - closely related *Bacillus cereus*, 420
 - milk and milk products, 60
- Bacillus botulinus*, 425
- Bacillus cereus*:
 - characteristics of, 419
 - diarrheal enterotoxin, 420
 - emetic toxin, 420
 - evaporated milk spoilage, 82
 - growth in milk, 423
 - hazard component in HACCP, 599
 - in the environment, 422
 - milk and milk products, 60, 652
 - psychrotrophic strains, 60, 419
 - shed in milk, 422
 - spoilage of milk and cream, 419
 - testing for, 420
 - toxin assays, 420
 - toxins produced, 420
- Bacillus cereus* food poisoning:
 - outbreaks, 421
 - prevention, 424
 - symptoms, 421
- Bacillus coagulans*, 82
- Bacillus licheniformis*, 82, 652
- Bacillus macerans*, 82
- Bacillus polymyxa*, 148, 370, 672
- Bacillus stearothermophilus*, 82
 - Delvotest-P, 444
 - disc assay, 444

- [*Bacillus stearothermophilus*]
 test for antibiotics in milk, 184, 444
 test for sterilization, 672
- Bacillus subtilis*, 82, 251, 259, 278, 672
- Bacillus thuringiensis*, 420
- Bacterial chromosome:
 chromosomal mapping, 261
 comparative genomics, 262
 pulsed-electric field gel electrophoresis, 261
- Bacterial standards:
 aseptically processed products, 63, 622
 coloring materials, 106
 condensed and dry milk products, 86
 fruit flavorings, 103
 ice cream, 116
 pasteurized cream for butter, 146
 pasteurized milk, 63, 622
 raw milk, 6, 64, 350, 622, 648
 syrups, 100
 water for washing butter, 140
 whey products, 90
 yogurt, 303
- Bacteriocins:
 acidocin, 188
 applications, 189, 190
 caseicin, 80, 186, 188
 commercial preparations, 189, 190
 dextranscin, 189
 diplococcin, 188
 enterocin B, 186
 helveticin, 186, 188
 jensenin, 189
 lactacin, 7, 147, 186, 188, 481
 lactin, 188
 lactocin, 186, 188
 lactococcin A, 186, 188
 mesenterocin, 189
 Microgard, 190
 nisin, 186, 188
 pediocin, 189
 propionicin, 189
 reuterin, 329
 role in probiotics, 329
 thermophilin, 189
- [Bacteriocins]
 various, 187
- Bacteriophages:
 characteristics of infection, 179
 culture rotation, 181
 defense mechanisms, 266
 description, 263
 evolution, 265–266
 genetically modified resistant strains, 181, 282
 genomes, 264–265
 genomic analysis, 267
 host range, 175
 intron, 259
 lytic, 264–265
 lytic cycle, 175–177
 morphology/taxonomy, 173–175
 origin, 264
 phage-host interactions, 175–178
 phage inhibitory media, 180
 phage-resistant cultures, 180–181, 266, 282
 preventing infection, 179
 prophage, 264
 pseudolysogeny, 177–178
 resistance in lactic acid bacteria, 178–179
 in rumen, 18
 sources in dairy plant, 182
 survival, 179
 taxonomy, 263
 temperate, 264–265, 279
 temperate cycle, 177
 transduction, 268
 virulent, 253
- Bacterium coli commune*, 447
Bacterium enteritidis, 465
Bacterium enterocolitica, 487
Bacteroides, 698
 Bactofugation, 71, 353
 Bactoscan, 64
 Bakery products, 104
 Beer, 388
 Beer-like beverages, 388
Beggiatoa spp., 697
 Beta-galactosidase production, 393, 394

- Beta-nitropropionic acid, 501
- Bifidobacterium*:
- acidophilus milk, 317
 - anaerobic waste digestion, 698
 - characteristics, 158–159
 - controls serum cholesterol, 334
 - enumeration, 161, 304
 - inhibits organisms, 328
 - probiotic use, 111, 159, 302, 327
 - yogurt, 304, 310, 336
- Bifidobacterium animalis*, probiotic use, 159
- Bifidobacterium bifidum*:
- added to ice cream mix, 111
 - probiotic use, 159
 - reduced viral shedding, 329
 - yogurt, 310
- Bifidobacterium breve*, yogurt, 310
- Bifidobacterium infantis*, yogurt, 310
- Bifidobacterium longum*:
- enhances immune system, 330
 - probiotic use, 159
 - yogurt, 310
- Biochemical oxygen demand (BOD):
- analytical procedure, 682–683
 - BOD/COD ratio, 684
 - defined, 682
 - milk soil, 555
 - values of products, 684
 - whey, 385–386
- Biofilms, 62
- cheese spoilage, 373
 - on equipment, 350, 373
 - rotating biological contactor, 697
 - trickling filter, 696
- Biological filtration to treat dairy wastes:
- biofilm, 696–697
 - categories, 696
 - nitrification, 696
 - rotating biological contactor, 697
 - trickling filter, 695–697
 - zooglear film, 696
- Blue-veined cheese:
- flavor, 160, 235, 360
 - Listeria monocytogenes*, 465
 - [Blue-veined cheese]
 - manufacture, 359
 - penicillia, 160, 235
 - ripening, 360, 371
 - Staphylococcus aureus*, 486
- Botryodiploidin (mycotoxin), produced by *P. paneum*, 160
- Botrytis*, 101
- Botulism:
- fatality rate, 427
 - outbreaks, 427–429
 - prevention, 430
 - symptoms, 427
 - treatment, 427
- Bovine spongiform encephalopathy, 496
- arisen from scrapie, 48
 - incidence, 48
 - prion, 48
 - symptoms, 48
 - transferred to humans, 48
- Brevibacterium*, characteristics of genus, 158
- Brevibacterium linens*:
- adjunct culture, 191, 235
 - characteristics, 158
 - metabolism, 235, 236
 - produces inhibitory compounds, 186
 - surface-ripened cheeses, 158, 365
- Brick cheese:
- behavior of enteropathogenic *E. coli*, 452
 - flavor development, 235
 - Listeria monocytogenes*, 465
 - manufacture, 364
 - reduced fat, 370
 - ripening, 365
 - smear, 365
 - Staphylococcus aureus*, 486
 - sweet, 365–366
- Brie cheese:
- botulism, 428
 - enteropathogenic *E. coli* illness, 450
 - flavor, 160, 235
 - Listeria monocytogenes*, 464
 - manufacture of, 361
 - penicillia, 160, 235

- [Brie cheese]
 - ripening, 362
 - Salmonella*, 476
 - Yersinia enterocolitica*, 494
- Brix, 99
- Brucella*:
 - description, 44–45
 - hazard component in HACCP, 599
 - milk and milk products, 60
 - tests for infections, 45
- Brucella abortus*:
 - cattle, 431
 - causes brucellosis in cattle, 44
 - characteristics, 431
 - primary isolation, 432
- Brucella melitensis*:
 - characteristics, 431
 - infects sheep and goats, 44
 - sheep and goats, 431
 - sheep milk cheese, 433
- Brucella ovis*, infects sheep, 44
- Brucella suis*, swine, 431
- Brucellosis:
 - Bang's disease, 431
 - control, 45
 - gradual onset form, 432
 - major public health concern, 398
 - Malta fever, 431
 - outbreaks, 432–434
 - prevention, 435
 - severity, 432
 - sudden onset form, 432
 - symptoms, 44, 431, 432
 - treatment, 432
 - undulant fever, 431
- Builders (detergent):
 - acid, 557, 559
 - alkaline, 557–558
 - enzymes, 557, 560
 - oxidizers, 561
 - water conditioners, 560–561
- Butter:
 - boat, 142
 - brines for salting, 141
 - brucellae in, 434
 - churning, 139
- [Butter]
 - composition, 127–128
 - consumption volumes, 127–128
 - continuous churn, 129
 - diphtheria, 405
 - few health problems, 399
 - food poisoning outbreaks, 142
 - freezing, 145
 - hazard analysis critical control points, 145
 - history, 127
 - large moisture droplets, 140
 - manufacture, 129–137
 - microbial control, 144–145
 - microbial tests, 669–670
 - moisture droplets in, 137, 139, 140, 144
 - mottling, 140
 - Mycobacterium bovis*, 409
 - NIZO method, 138
 - packaging, 141
 - quality assurance, 145
 - ripened cream, 128
 - salting, 140
 - spoilage, 143
 - staphylococcal poisoning, 478, 482–483
 - Staphylococcus aureus*, 485
 - sweet cream, 128
 - typhoid fever, 410–411, 413
 - unsalted, 145
 - washing, 140
 - whey cream, 129
 - whipped, 142, 146
 - working of, 137, 139
- Butyrivibrio fibrosolvens*, 28, 37
- Cacao beans fermented, 100
- Camel, 2
- Camembert cheese:
 - aflatoxin, 418
 - Brucella abortus* in, 435
 - E. coli* O157:H7 survival in, 457
 - enteropathogenic *E. coli* behavior in, 451
 - flavor, 160, 235

[Camembert cheese]

- Listeria monocytogenes*, 464
- manufacture, 361
- penicillin, 160, 235
- ripening, 362, 371
- survival of *Mycobacterium bovis*, 409

Campylobacter:

- characteristics of, 436
- incidence in milk, 440
- isolation and identification, 436–437
- raw milk-associated outbreaks, 398
- sensitive to environment, 441
- survival in milk, 440–441

Campylobacter coli, 436*Campylobacter fetus* ssp. fetus, 436*Campylobacter hypointestinalis*, 436

Campylobacteriosis:

- complications, 437
- diagnosis of, 438
- major public health concern, 398
- oral infective dose, 437
- outbreaks, 438–440
- prevention, 441
- symptoms, 437
- treatment, 438

Campylobacter jejuni:

- bovine intestinal tract, 440
- characteristics of, 436
- hazard component in HACCP, 599
- isolation and identification, 436–437
- milk and milk products, 60, 97
- oral infective dose, 437
- shed by cows, 440

Campylobacter lari, 436*Campylobacter upsaliensis*, 436*Candida*, 99, 360, 362, 365, 375*Candida kefyr*, 317, 390

Carbon dioxide:

- cottage cheese preservation, 358
- milk preservative, 72

Carchesium, 692*Carnobacterium*, 243–244, 246

Casein micelles, 348–349

Cellulose:

- cellulolytic species populations, 22
- digestion, 20
- hydrolytic products, 21
- nature of, 19
- plant cell walls, 19, 20

Centrifugation, 71, 353

Champagne, 388

Cheddar cheese:

- aflatoxin, 418
- Bacillus cereus* in, 424
- bitter flavor, 162
- calcium lactate crystals, 379
- Campylobacter* survival in, 441
- desirable properties of starter cultures, 162
- E. coli* 0157:H7 survival in, 457
- flavor, 163, 229
- histamine poisoning, 499
- homofermentative lactic starter, 211, 245
- Listeria monocytogenes*, 465
- manufacture, 366
- molds, 374
- outbreaks of illness, 399
- pink defect, 378
- proteolysis, 162–163
- psychrotrophic bacteria caused defects in, 654
- reduced fat, 369
- ripening, 162, 372
- Salmonella* in, 476, 477
- salmonellosis, 473
- staphylococcal poisoning, 482
- Staphylococcus aureus*, 485
- survival of *Mycobacterium bovis*, 409
- toxigenic molds, 501
- typhoid fever, 412–413
- Yersinia enterocolitica*, 493

Cheese (see also individual cheese varieties):

- acid curd, 349–350
- aflatoxin, 418
- Bacillus cereus* food poisoning, 421–422
- blue-mold cheeses, 359–361
- botulism, 428

[Cheese]

brucellosis, 432–435
 Camembert/Brie, 361–362
Campylobacter, 441
 Cheddar cheese, 366
Citrobacter freundii, 495
 cleaning/sanitizing of production facilities, 565
 Colby and sweet brick, 365–366
 contaminants, 354
 cottage, 356–358
 defects, 372–379
 defects from thermophilic bacteria, 353
 desired characteristics, 346
 drug residues, 445
 encephalitis (tickborne), 504
 enterohemorrhagic *Escherichia coli* 0157:H7, 452–458
 enteropathogenic *Escherichia coli*, 447–452
 flavor, 355, 371–372
 histamine poisoning, 498–499
 history, 345
 infectious hepatitis, 499
 listeriosis, 458–466
 microbiological testing, 674–675
 microbiology, 354–355
 Muenster and Havarti, 365–366
 mycotoxins, 500–501
 outbreaks of illness, 399
 Parmesan/Romano, 368–369
 pasta filata cheeses, 367–368
 problems, 345
 process, spreads, cold-pack, 370–371
 quality affected by milk, 350–351
 reduced fat, 369–370
 rennet curd, 347–349
 ripening (maturation), 346, 354, 371–372
 scarlet fever, 406
 shigellosis, 503
 staphylococcal poisoning, 478–486
Streptococcus zooepidemicus, 504
 surface ripened, 364–365
 survival of *Mycobacterium bovis*, 409

[Cheese]

typhoid fever, 410–413
 with eyes, 362–364, 375
 yersiniosis, 486–494
 Cheese defects:
 assessment, 372–374
 calcium lactate crystals, 379
 discoloration, 378–379
 gas, 375–378
 molds, 374
 yeasts, 374–375
 Cheese making:
 acid curd cheese, 349–350
 acid development, 348–349
 adjunct cultures, 355
 affected by somatic cell counts, 68
 clarification of milk, 351
 coagulum formation, 346, 348
 direct acid addition, 349
 guidelines, 345
 heat treatment of milk, 352–353
 rennet curd cheese, 347–349
 ripening, 371–372
 role of protein metabolism of starter, 228–229
 standardization of milk, 351–352
 Cheese spreads, 370
 botulism, 428, 430
 recall, 403
 Chemical oxygen demand:
 BOD/COD ratio, 684
 defined, 684
 measuring, 684
 Chemostat, 10
Chilodonella, 692
 Chlorine sanitizers:
 advantages, 573
 affect starter cultures, 185, 305
 characteristics of compounds, 572
 chemistry, 571
Cryptosporidium is resistant, 497
 disadvantages, 573
 free available chlorine, 571
 hypochlorous acid content, 572
 oxidizers in detergents, 561
 properties, 571

- Chocolate:
 milk, 72
 powder, 72
- Cholesterol, serum:
 assimilated by *Lactobacillus acidophilus*, 333
 bile acids deconjugated, 333–334
 reduced by probiotics, 333
- Chymosin, 347
- Ciliates, 692
- Citrate metabolism:
 cultured buttermilk, 311
 diacetyl contributes to flavor, 230, 311
 diacetyl synthesis, 230
 enhancing diacetyl formation, 232–233
 fermentation pathway, 231
Lactococcus lactis spp. *lactis* biovar. *diacetyllactis*, 230
Leuconostoc, 230
 transport, 232
- Citrobacter*, 61
- Citrobacter freundii*:
 dairy foods, 495
 gastroenteritis, 495
 symptoms, 495
 verotoxin production, 495
- Cladosporium*, 143, 374, 501
- Clarification-milk, 71
- Cleaned-in-place procedures, 62, 554, 594
- Cleaned-out-of-place, 554, 594
- Cleaning procedures:
 by-product and further processing, 566
 cheese production, 565
 dairy farms, 562
 plant-pasteurized milk, 564
 plant-raw milk handling, 563
- Cleaning process:
 cleaning equation, 552
 cleaning in place, 554, 594
 cleaning out of place, 554, 594
 environmental considerations, 555
 foam, gel, thin-film cleaning, 553
- [Cleaning process]
 hand/manual cleaning, 553, 594
 nature of soils, 548
 spray/high pressure cleaning, 553
 surfaces, 552
 water, 550
- Clostridium aminophilum*, 29
- Clostridium botulinum*:
 cheese spread, 403
 description of, 425
 hazard component in HACCP, 599
 in environment, 429
 inhibited by nisin, 188
 milk and milk products, 60
 neurotoxin groups, 426
 neurotoxins, 425
 process cheese, 370
 testing for, 426
 testing for toxin, 426–427
 toxin, 425
 type E is psychrotrophic, 60
- Clostridium butyricum*, process cheese, 370
- Clostridium formicoaceticum*, 393
- Clostridium perfringens*:
 hazard component in HACCP, 599
 milk and milk products, 60
- Clostridium* species:
 anaerobic waste treatment, 698
 in cream, 137–138
 in dry milks, 85
 gas in cheese, 377
 inhibited by lactacin, 188
 in milk, 61, 652
 polymerase chain reaction, 355
 in rumen, 13
 silage, 350
 spores survive pasteurization, 353
- Clostridium sporogenes*:
 inhibited by carbon dioxide, 358
 inhibited by thermophilin, 189
 process cheese, 370
- Clostridium sticklandii*, 29
- Clostridium thermocellum*, 21

Clostridium tyrobutyricum:

- gas in cheese, 376–377
- inhibited by thermophilin, 189
- process cheese, 370
- sodium nitrate to control, 353
- stinker cheese, 364

Coagulants:

- activity of, 348
- calf rennet, 347
- chymosin, 347
- other rennets, 347

Code of Federal Regulations, Title 21,
138, 638

Colby cheese:

- behavior of enteropathogenic *E. coli*,
451–452
- calcium lactate crystals, 379
- description, 365
- manufacture, 366
- pink defect, 378
- ripening, 366
- typhoid fever, 412
- Yersinia enterocolitica*, 493

Cold-pack cheese:

- defects, 370
- manufacture, 370
- Salmonella*, 477

Cold-shock proteins, 96

Coliform count, 65, 68, 95, 116, 119,
120, 657, 664, 669–670, 673, 675

Coliforms:

- butter, 669, 670
- in cheese, 352, 675
- contaminate starter cultures, 314
- cottage cheese contaminants, 357,
668
- defined, 117
- dry milk and whey products, 670
- fecal, 450, 453
- fluid milk products, 664
- fruit flavorings, 103
- gas in cheese, 376
- ice cream, 95, 116, 669
- killed by pasteurization, 117
- Limburger cheese, 365
- off-flavors in cultured buttermilk, 314

[Coliforms]

- pasteurized cream, 146
- raw milk, 61, 62, 657
- spoilage of milk, 66
- survival in cultured dairy products,
673–674
- test for, 117
- water, 552

Colorant, 106–107

Colostrum, 7

Commercial sterility, 81

*Compendium of Methods for the Micro-
biological Examination of Foods*,
118

Condensed milk, 77

- ice cream ingredient, 98
- microbial spoilage, 78–79
- processing scheme, 78
- uses, 78

Condensed whey products, 77

Confections, 104

Conjugated linoleic acid

- antiatherogenic, 37
- anticarcinogen, 37
- immunomodulating activity, 37
- milkfat as source, 37
- produced by bacterial action, 37

Corynebacterium, 61, 353, 687

Corynebacterium bovis, 61

Corynebacterium diphtheriae, 404, 405,
495

Corynebacterium pseudotuberculosis,
495

Corynebacterium spp., milk and milk
product, 60

Corynebacterium ulcerans:

- raw milk, 495
- symptoms, 495
- toxins produced, 495

Cottage cheese:

- behavior of enteropathogenic *E. coli*,
452
- botulism, 428
- brucellosis, 434
- Campylobacter* survival, 441
- causes of shelf-life problems, 667–668

- [Cottage cheese]
 - coliform survival in, 673–674
 - defect, 356
 - E. coli* 0157:H7, 457
 - flavor, 357
 - floating curd, 358
 - homofermentative lactic starter, 211
 - listeriosis, 461
 - manufacture, 356
 - Mycobacterium bovis*, 409
 - pasteurized milk, 352
 - preservation, 358
 - psychrotrophic contaminants, 357
 - Salmonella*, 476
 - spoilage bacteria, 357, 668
 - tests, 668
- Coulomiers cheese, enteropathogenic *E. coli* illness, 450
- Coxiella burnetii*:
 - carriers of, 501
 - causes Q-fever, 501
 - dairy-related illness, 398
 - milk and milk products, 60, 502
 - milk pasteurization, 68, 352, 502
- Cream:
 - Bacillus cereus* food poisoning, 419
 - bacterial standards, 436
 - brucellosis, 434
 - half and half, 73
 - heavy, 73
 - microbiology, 137–138
 - pasteurization, 135
 - ripened cream butter, 128
 - ripening, 138
 - sour, 314–316
 - spoilage, 61
 - sweet cream butter, 128
 - whery cream, 129, 142
 - whipping, 72–73
- Cream cheese:
 - defects, 349
 - listeriosis, 461
 - manufacture, 349
 - Mycobacterium bovis*, 409
- Crème fraîche, 314
- Creutzfeldt-Jakob disease:
 - caused by prion, 495
 - new variant, 496
- Crohn's disease, 500
 - associated with *M. paratuberculosis*, 44
- Cryptococcus*, 101
- Cryptosporidiosis:
 - gastrointestinal infection, 496–497
 - raw milk, 497
 - symptoms, 497
- Cryptosporidium*:
 - cryptosporidiosis, 496, 497
 - dairy related illness, 398
 - in environment, 497
 - hazard component in HACCP, 599
 - recall of products, 403
 - resistant to sanitizers, 497
- Culinary steam, 70
- Cultured buttermilk:
 - citric acid fermentation, 311
 - coliform survival in, 673–674
 - defects, 313–314
 - desirable properties of starter cultures, 164
 - E. coli* 0157:H7 survival in, 457
 - exopolysaccharides, 164
 - flavor, 164, 311
 - green apple flavor, 164
 - Listeria monocytogenes*, 464
 - manufacture of, 312
 - starter cultures used, 312–313
- Cultured dairy products—microbiological testing:
 - coliform count, 673
 - coliform survival in, 673–674
 - yeast and mold count, 674
- Cyclopiazonic acid:
 - Camembert cheese, 501
 - produced by aspergilli, 501
 - produced by *P. camemberti*, 160, 501
- Dairy animal:
 - digestive tract, 4
 - Holstein, 2
 - lactation schedule, 2

- [Dairy animal]
 - populations, 2
 - production, 2–3
- Dairy chemistry, 346
- Dairy farm inspection, 624–625
- Dairy foods—associated illnesses:
 - afatoxin, 414–418
 - Bacillus cereus* food poisoning, 418–424
 - botulism, 424–430
 - brucellosis, 430–435
 - campylobacteriosis, 435–441
 - Citrobacter freundii*, 495
 - Corynebacterium ulcerans*, 495
 - Creutzfeldt-Jakob disease, 495, 596
 - Cryptosporidiosis, 496, 497
 - current concerns, 413–494
 - diphtheria, 404
 - drug residues, 442–447
 - encephalitis (tickborne), 504
 - enterohemorrhagic *Escherichia coli* 0157:H7, 452–458
 - enteropathogenic *Escherichia coli*, 447–452
 - Haverhill fever, 497, 498
 - histamine poisoning, 498, 499
 - historical concerns, 403–413
 - infectious hepatitis, 499, 500
 - Johne's and Crohn's diseases, 500
 - listeriosis, 458–465
 - mycotoxins, 500, 502
 - outbreaks, 397, 400, 401, 402
 - salmonellosis, 465–478
 - scarlet fever/septic sore throat, 405, 406
 - shigellosis, 502, 503
 - staphylococcal poisoning, 478–486
 - Streptococcus zooepidemicus*, 503
 - toxoplasmosis, 504–505
 - tuberculosis, 407, 408
 - typhoid fever, 410–413
 - uncommon and suspected concerns, 494–405
 - yersiniosis, 486–494
- Dairy processing plants:
 - buildings and surroundings, 589
 - [Dairy processing plants]
 - calibration of equipment, 593
 - chlorination of water, 590
 - cleaning procedures, 563–566
 - composition of products, 685
 - drainage and sewage systems, 589
 - employee hygiene, 144, 593–594
 - equipment design and installation, 592
 - equipment performance and maintenance, 592
 - equipment test report, 628–629
 - floor baths, 94
 - floor drains, 94
 - floor mats, 94
 - floors, walls, and ceilings, 589
 - hand washing, 590
 - Hazard Analysis Critical Control Point, 598–599
 - hazard components, 599–600
 - hygienic practices, 94, 144, 589
 - ice, 591
 - inspection report, 626–627
 - land, 588
 - lighting, 589
 - model HACCP programs, 607–611
 - monitoring devices, 592, 593
 - personnel training, 593, 594
 - pest control program, 595
 - premises, 588–591
 - preventive maintenance, 593
 - processing areas, 590
 - product losses, 683
 - raw materials, ingredients, 591
 - recalls, 95, 117, 595–597, 639–640
 - receiving and storage, 591–592
 - return or damaged product, 592
 - sources of bacteriophages, 182
 - steam, 591
 - storage and transport conditions, 592
 - traffic patterns, 589, 590
 - washrooms, 590
 - water control program, 590
 - water treatment chemicals, 591
 - written sanitation program, 594–595
 - Dairy Product Safety Initiative, 94

- Dairy regulations (*see also* Regulatory controls):
- adulterated dairy foods, 399
 - Codex Alimentarius Commission, 598, 641
 - Code of Federal Regulations*, Title 21, 638
 - evaluation of milk laboratories, 630, 632, 634
 - Factory Inspection Act of 1953, 614
 - Fair Packaging and Labeling Act of 1966, 638–639
 - farm inspection, 624–625
 - Federal Food, Drug and Cosmetic Act, 637–638
 - Food and Drug Administration, 616, 619, 639–640
 - future of, 641
 - Grade A Condensed and Dry Milk Ordinance, 623
 - history, 614–615
 - local health departments, 614
 - National Conference on Interstate Milk Shipments, 615–620
 - Nutrition Labeling and Education Act of 1990, 638
 - Occupational Safety and Health Administration, 640
 - Pasteurized Milk Ordinance, 620
 - recalls, 95, 117, 639, 640
 - risk-based system, 641
 - sanitation ratings of milk supplies, 634
 - standards to prevent botulism, 430
 - 3-A sanitary standards, 636, 637
 - U.S. Dept. of Agriculture, 614–615, 635
 - waste treatment, 682, 700
 - zero-tolerance for *L. monocytogenes*, 399
- Dairy wastes:
- BOD/COD ratio, 684
 - BOD values of products, 684
 - chloride, 684–685
 - composition, 682–683
 - discharge permit, 682
 - discharge to surface waters, 700
- [Dairy wastes]
- environmental regulations, 682, 700
 - nitrogen removal, 687, 693–694
 - objectives of treatment, 681–682
 - phosphorus in, 684, 687–688, 693–694
 - product losses, 683
 - quantity, 682
 - reduce volume, 700
 - sources, 681, 683
- Dairy waste treatment
- activated sludge, 690–695
 - anaerobic digestion, 697–700
 - biological filtration, 695–697
 - land application, 685–688
 - ponds or lagoons, 689–690
 - screen and grit chamber, 685
- Daphnia magna*, 695
- Dastrichia*, 17
- Debaromyces hansenii*, 360, 362, 365, 375
- Desulfovibrio*, 697
- Detergent ingredients:
- builders, 556, 557, 559–561
 - fillers, 561–562
 - miscellaneous, 562
 - surfactants, 555–556
- Diphtheria:
- butter, 405
 - complications, 404
 - dairy workers, 405
 - description, 404
 - diphtheria antitoxin, 404–405
 - diphtheroid toxin, 404
 - ice cream, 405
 - immunization programs, 405
 - raw milk, 397–398, 405, 613
 - symptoms, 404
 - treatment, 404–405
 - yogurt, 405
- Diplodinia*, 17
- Dolosigranulum*, 243
- Drug residues:
- allergenic drugs, 443–444
 - antibiotic-resistant pathogens, 445
 - aplastic anemia, 444
 - beta-lactam antibiotics, 442

- [Drug residues]
 - carcinogens, 444
 - detection methods, 443–444
 - disease treatment, 442
 - excretion in milk, 442
 - occurrence, 445–446
 - other antibiotics, 443
 - prevention, 446–447
 - resistance to heat, 442–443
 - risks of, 444–445
 - starter cultures affected, 445
 - sulfamethazine, 443
 - sulfonamides, 443
 - suppress immune system, 444
 - withdrawal period, 442
- Dry milks:
 - Bacillus cereus* food poisoning, 419, 421–424
 - bacterial standards, 85–86
 - drying processes, 83
 - few health problems, 399
 - history, 82–83
 - ice cream ingredient, 98
 - instant-type products, 84
 - manufacture, 83–84
 - microbiology, 85, 87
 - nonfat dry milk processing, 84
 - products, 83
 - salmonellosis, 472, 475
 - solubility index value, 84
 - Staphylococcus aureus*, 485
 - testing, 670
 - whey protein nitrogen test, 84
 - yersiniosis, 490–491
- Dry whey products, 77 (*see also* Whey)
 - history, 87
 - products, 87
 - testing, 670
- D-value, 70
- Edam cheese, eyes, 362
- Edwards medium, 65
- Eggs and egg products, 104
 - contamination, 105
 - egg white, 105
 - egg yolk, 104
- [Eggs and egg products]
 - pasteurized egg yolk, 104
- Electrodialysis, whey, 88
- Electroporation, 276, 277
- Emlden-Meyerhoff pathway, 208–209, 211, 213, 217
- Encephalitis (tickborne):
 - cheese, 504
 - raw milk, 504
 - symptoms, 504
- Entamoeba histolytica*, milk and milk products, 60
- Enterobacter*, 61
- Enterobacter aerogenes*:
 - cottage cheese contaminant, 357
 - diacetyl reductase, 314
 - oxidizes diacetyl, 358
- Enterobacter agglomerans*, 357
- Enterococcus*, 106, 153
 - butter, 669
 - characteristics, 158
 - in cheese, 244
 - cheese spoilage, 375
 - enumeration, 161
 - foodborne illness, 158
 - spots on cheese, 378
 - starter cultures, 158
 - stinker cheese, 364
 - survive pasteurization, 353
 - taxonomy, 244
- Enterococcus faecalis*:
 - characteristics, 158
 - group II intron, 260
 - low-fat spreads, 147
 - misti doi, 320
- Enterococcus faecium*:
 - characteristics, 158
 - low-fat spreads, 147
 - produces bacteriocin, 186
 - spoilage of low-fat spreads, 148
- Enteropathogenic *Escherichia coli*:
 - categories of, 144
 - characteristics of, 447–448
 - in cheese, 450–451
 - methods to isolate and detect, 448–449
 - toxin deflection, 448, 449

- Enteropathogenic *Escherichia coli* illness:
 cheese, 450
 indistinguishable from shigellosis, 449
 infantile diarrhea, 449
 outbreaks, 449–450
 prevention, 452
 raw milk, 450
 symptoms, 449
 traveler's diarrhea, 449
- Entodinium*, 17
- Environmental Protection Agency:
 dairy wastes, 682
 role in dairy industry, 640
 sanitizer control, 564, 567
- Enzymes, heat-stable, 64–65, 67, 98
- Epifluorescence microscope, 64, 305
- Eremococcus*, 243
- Ergot alkaloids, 501
- Escherichia*, 61
- Escherichia coli* (see also Enteropathogenic *Escherichia coli*):
 butter, 146
 Camembert/Brie cheese, 362
 colorants, 106
 controlled by *Bifidobacterium*, 330
 controlled by *Lactobacillus acidophilus*, 329, 337
 cottage cheese contaminant, 357
 group II intron, 260
 hazard component in HACCP, 599
 inhibited by propionicin, 189
 lactose permease, 216
 milk and milk products, 60
 plasmids, 247
 raw milk, 98
 recalls of products, 399
 shuttle vector, 278
 survives spray drying, 85, 87
 syrup, 100
- Escherichia coli* 0157:H7:
 cattle major reservoir, 45
 low infectious dose, 45
 pathogenicity, 46
 prevalence in cattle herds, 45, 46
- Escherichia coli* 0157:H7 (enterohemorrhagic):
 characteristics, 453
 dairy foods, 457
 destroyed by pasteurization, 457
 early outbreaks, 452–453
 hazard component in HACCP, 599
 hemolytic uremic syndrome, 398, 454
 hemorrhagic colitis, 454
 methods to isolate and detect, 453, 454
 milk and milk products, 60
 outbreaks related to dairy foods, 455, 456
 prevention, 458
 serogroups, 453
 starter cultures, 457
 survival in yogurt, 457
 testing for, 120
 threat to dairy industry, 398
 thrombotic thrombocytopenic purpura, 454, 455
 verotoxins, 453
- Escherichia faecalis*, 246, 261, 262, 271, 273
- Ethanol production:
 Carbery process, 390–391
 cofermentation process, 391–392
- Evaluation of milk laboratories:
 certification of laboratories, 630
 evaluation form, 632–633
 sampling and personnel, 630
 split samples, 634
- Evaporated milk, 77
 flat-sour spoilage, 82
 history, 79–80
 manufacture, 80–81
 microbiology, 81–82
 nisin added, 72
 products, 80
 staphylococcal poisoning, 482
- Exopolysaccharide:
 cultured buttermilk, 313

- [Exopolysaccharide]
 - heteropolysaccharide, 166
 - impacts resistance to freezing, 108–109
 - increasing synthesis, 236
 - produced by lactococci, 154
 - produced by leuconostocs, 155
 - producing lactic bacteria and phage, 181
 - production-transfer of genes, 253
 - sour cream, 164
 - yogurt, 165–167, 310
- Factory Inspection Act of 1953, 614
- Fair Packing and Labeling Act of 1966, 638–639
- Farm bulk milk tanks, 68, 562
- Fat globule membrane, 66
- Fatty acid sanitizers:
 - advantages, 575
 - disadvantages, 576
 - properties, 575
- Federal Food, Drug and Cosmetic Act, 637, 638
- Fermented milks:
 - acidophilus milk, 316–317
 - consumption, 302
 - cultured buttermilk, 311–314
 - dahi, 319, 320
 - enumeration of lactic acid bacteria, 303–305
 - ghee, 320
 - history, 301
 - inhibition of culture organisms, 305
 - kefir, 317
 - kishk, 321
 - koumiss, 317–318
 - laban khad, 321
 - laban rayab, 321
 - laban zeer, 321
 - labneh, 321
 - microorganisms used to make, 302–303
 - misti doi, 320
 - skyr, 318, 319
 - srikhand, 320
- [Fermented milks]
 - types, 306
 - viili, 318
 - ymer, 318
 - yogurt, 307–311
 - zabady, 321
- Fermented whey beverages:
 - gefilus, 389
 - rivella, 389
- Feta cheese:
 - Bacillus cereus* food poisoning, 421
 - Staphylococcus aureus*, 486
 - Yersinia enterocolitica*, 493
- Fibrobacter succinogenes*, 20–23
- Filtration, milk, 71
- Flavobacterium*, 60, 67, 357, 685, 690, 696
- Flavorings:
 - chocolate, 100
 - extracts, 100
- Foamy bloat, 32–33
- Food and Drug Administration, 614
 - NCIMS agreement, 616
 - NCIMS proposals to, 619
 - role in recalls, 639, 640
 - transferred from USDA, 614
- Foodborne illnesses (*see* Dairy foods—associated illnesses, and also individual illnesses)
- Food, Drug, and Cosmetic Act of 1938, 399, 614
- Food labeling laws, 637, 639
- Freezing of dairy desserts:
 - cold-shock proteins, 96
 - concentration of dissolved substances, 95
 - cryohydric point, 96
 - eutectic points, 96
 - freezing point, 96
 - freezing process, 115–116
 - intracellular ice crystals, 96
 - kills bacteria, 106
 - latent heat of fusion, 96
 - pH, 96
 - rate of temperature decrease, 96
 - survival of microorganisms, 95–96

- Frozen yogurt, 93
 composition, 97, 107–110
 freezing, 96
 manufacture, 107–110
 probiotic nature, 110
 properties, 107–110
 recalls, 95
 testing, 668
- Fruits:
 candied, 103
 fresh and frozen, 101
 processed, 102
- Fungi (*see also* Molds, and Yeasts):
 in milk and milk products, 60
 osmophilic, 99
 populations, 19
 roles, 19
 in rumen, 18, 19
- Fusarium*, 101, 374, 501
- Gemella*, 243
- Genetic elements, 245–267
 bacterial chromosomes, 261–263
 bacteriophages, 263–267
 comparative genomics, 262–264
 plasmid DNA, 245–252
 plasmid replication, 246–252
 rolling circle plasmid replication,
 247–251
 theta plasmid replication, 251–
 252
 transposable elements, 252–261
- Genetic improvement of lactic acid bac-
 teria:
 diacetyl production, 282–283
 enhanced phage resistance, 282
- Gene transfer mechanisms:
 conjugation, 269–276, 282
 DNA mobilization, 273–276
 electroporation, 276–277
 food-grade gene cloning systems,
 280
 gene delivery systems, 278
 integrative gene cloning, 279–280
 mating pair formation, 271–273
- [Gene transfer mechanisms]
 pheromones/sex factors, 271–273
 protoplast fusion, 268–269
 replicative vectors, 278–279
 transduction, 268
 transformation, 276–280
- Geotrichum*, 101, 143, 501
- Geotrichum candidum*:
 Camembert/Brie cheese, 362
 cheese spoilage, 375
 surface-ripened cheeses, 365
 viili, 318
- Giardia lamblia*, milk and milk prod-
 ucts, 60
- Globicatella*, 243
- Gluconobacter*, 101, 392
- Goats, 2, 6
- Goat's milk:
 campylobacteriosis, 440
 cryptosporidiosis, 497
 encephalitis (tickborne), 504
 Q-fever, 502
 staphylococcal poisoning, 482–483
 toxoplasmosis, 505
- Goat's milk cheese:
 brucellosis, 433
Listeria monocytogenes, 465
- Gorgonzola cheese:
 flavor, 160, 235
 penicillia, 160, 235, 359
- Gouda cheese:
 defect, 364
 eyes, 362
 histamine poisoning, 499
 homofermentative lactic starter, 211,
 245
 molds, 374
 reduced fat, 370
 ripening, 364
Staphylococcus aureus, 486
- Grade A Condensed and Dry Milk ordi-
 nance, 623
- Grass tetany, 33–34
- Gruyère cheese:
Brucella abortus in, 435
 histamine poisoning, 499

- Habrotrocha*, 692
- Havarti cheese:
 description, 365
 manufacture of, 366
 ripening, 366
- Haverhill fever:
 complications, 498
 raw milk, 498
 symptoms, 498
- Hazard Analysis and Critical Control Point (HACCP) program:
 control microorganisms, 587
 employee education and training, 606–607
 hazard components, 599–600
 history, 597–598
 implementation, 600–606
 model programs, 607–611
 prerequisite program, 587–597
 principles, 598–599
- Helicobacter pylori*, controlled by *Lactobacillus acidophilus*, 329
- Hemicelluloses, 22
- Hepatitis A (infectious hepatitis):
 dairy-related illness, 398
 hazard component in HACCP, 599
 strawberries, 101
 symptoms, 499
- Hindgut fermentations, 37–38
- Hispanic cheese, no growth of *E. coli* 0157:H7, 457
- Histamine poisoning:
 outbreaks, 499
 symptoms, 498
- Honey:
 butter, 145
 ice cream, 100
- Horse:
 koumiss from mare milk, 317–318
 milk source, 2
- Hot water sanitizing:
 advantages, 577
 disadvantages, 577
 properties, 576
- Hydrogen transfer—rumen:
 anaerobic metabolism, 26
- [Hydrogen transfer—rumen]
 homoacetogens, 28
 methanogens, 26–27
 sulfate-reducing bacteria, 28
- Hydrophobic grid membrane filter, most probable count, 64
- Ice cream:
Bacillus cereus food poisoning, 419, 424
 coliforms, 95
 composition, 95–97
 diphtheria, 405
 environmental contaminants, 94
 freezing, 96, 115
 frozen storage, 115
 industry standards, 116
 infectious hepatitis, 499
 ingredients, 97–107
 microbiological quality, 95
 microbiological test methods, 118–120, 668–669
 microbiology, 93
 novelties, 113
 outbreak of illness increases, 399
 processing, 113–114
 recalls, 95
 regulatory controls, 116–118
Salmonella Enteritidis, 95, 473, 475
 scarlet fever, 406
 serving, 116
 staphylococcal poisoning, 478, 482–483
Staphylococcus aureus, 485
 typhoid fever 399, 411–413
- Immune response:
 control of intestinal infections, 330
 enhanced by probiotics, 330
- Impedance/conductance method, 64
- Implementation of HACCP:
 conduct a hazard analysis (step 5) (principle 1), 601–602
 corrective actions (step 9) (principle 5), 604
 critical control points (step 6) (principle 2), 602–603

- [Implementation of HACCP]
 - critical limits (step 7) (principle 3), 603
 - describe dairy food and distribution method (step 2), 600
 - develop and a verify flow diagram (step 4), 601
 - evaluating and revising HACCP systems (step 12), 605
 - gain management commitment and assemble team, (step 1), 600
 - identify intended use and potential consumers (step 3), 601
 - monitoring/inspection (step 8) (principle 4), 603–604
 - records (step 10), (principle 6), 604
 - verification (step 11) (principle 7), 605, 645
- Indian cultured milks:
 - dahi, 319
 - ghee, 320
 - misti doi, 320
 - srikhand, 320
- Infectious diseases of dairy animals:
 - bovine spongiform encephalopathy, 48
 - brucellosis, 44–45
 - enteropathogenic *Escherichia coli*, 45–46
 - Johne's disease, 43–44
 - major diseases, 39
 - mastitis, 38–41
 - paratuberculosis, 43–44
 - tuberculosis, 41–43
 - viral diseases, 46–47
- Interactions of starter cultures, 191
 - amensalism, 192
 - commensalism, 192
 - competition, 192
 - mutualism, 192
 - parasitism, 192
- International Dairy Foods Association, 620
- Intestinal tract organisms:
 - antimicrobial substances, 329
 - bacteriocins, 329
 - [Intestinal tract organisms]
 - competitive exclusion, 330, 337
 - controlled by probiotics, 328
 - controlled in livestock, 337
 - immune response, 330
- Iodine sanitizers (iodophors):
 - advantages, 573
 - bacterial efficacy, 574
 - disadvantages, 573–574
 - effect on starter cultures, 185
 - production, 573
 - properties, 573
- Isotricha*, 17
- Johne's disease:
 - association with Crohn's disease, 500
 - control, 44
 - symptoms, 43, 44, 500
- Kefir:
 - alcohol present, 302
 - bodrost production, 389
 - defects, 317
 - grains, 317
 - manufacture, 317
 - starter organisms, 317
- Klebsiella*, 61
- Kluyveromyces lactis*, 360
- Kluyveromyces marxianus*:
 - beta-galactosidase production, 394
 - Camembert/Brie cheese, 362
 - cheese spoilage, 375
 - ethanol production, 390, 392
- Kojic acid, 501
- Koumiss:
 - culture organisms, 318
 - manufacture, 317–318
 - therapeutic purposes, 317
- Laboratory pasteurized count, 65–66
- Lachnospira multipara*, 24
- Lactic acid bacteria (*see also* individual genera and species):
 - acid injury, 304
 - acidophilus milk, 316, 317
 - activity tests, 190, 191

- [Lactic acid bacteria (*see also* individual genera and species)]
- adjunct cultures, 191, 192
 - amino acid/peptide transport systems, 224, 225
 - antibiotics in milk, 184, 185
 - bacteriophage genomes, 264, 267
 - bacteriophage resistance, 178, 179
 - bacteriophages, 173–182, 263
 - benefits as probiotics, 328–335
 - blue-mold cheese starter, 359
 - bodrost, 389
 - in Camembert/Brie cheeses, 361
 - characteristics of bacteriophage infection, 179
 - characteristics needed for probiotic cultures, 335–336
 - in Cheddar cheese, 366
 - cheese ripening, 371
 - cheeses with eyes, 362–364
 - chemical sanitizers, 185
 - citrate metabolism, 230–233
 - in Colby and sweet brick cheeses, 366
 - commercial preparations, 171–173
 - conjugation, 269–276
 - contaminated culture, 314
 - cottage cheese starter, 356, 358
 - cultured buttermilk, 312, 313
 - dahi, 319
 - desirable properties, 162–167
 - discovery of fermentation, 244
 - DNA mobilization, 273–276
 - electroporation, 276, 277
 - Embden-Meyerhoff pathway, 208
 - enterococci, 158
 - enumeration, 160–162, 303, 304, 305
 - external pH control, 170
 - flavor adjuncts—cheese, 229, 230
 - food-grade gene cloning systems, 280
 - freeze-dried cultures, 172
 - frozen concentrated cultures, 172,
 - galactose metabolism, 218–220
 - gene delivery systems, 278
 - general characteristics, 152, 153, 207, 243
- [Lactic acid bacteria (*see also* individual genera and species)]
- genetically modified, 192, 193, 194
 - genetic elements, 245–267
 - genetic improvement, 280–283
 - genetics-why study, 244, 245
 - gene transfer mechanisms, 267–280
 - genomics, 263
 - growth media formulations, 168, 169
 - heterofermentative, 208, 210, 220
 - histamine formation, 498–499
 - homofermentative, 208, 209, 211, 220
 - incubation conditions, 171
 - inhibitors in raw milk, 182–184
 - integrative gene cloning, 279, 280
 - interactions of cultures, 191, 192
 - internal pH control, 170, 171
 - kefir, 317
 - koumiss, 317, 318
 - lactobacilli, 155, 156, 157
 - lactococci, 153, 154
 - lactose permease, 211, 216, 218
 - lactose phosphotransferase system, 211–213, 218
 - Leloir pathway, 219, 220
 - leuconostocs, 154, 155
 - mating pair formation, 271–273
 - metabolic engineering, 236
 - Middle Eastern fermented milks, 321
 - misti doi, 320
 - Muenster and Havarti cheeses, 366
 - natural habitat, 153
 - nutritional requirements, 167, 168
 - in Parmesan/Romano cheeses, 368–369
 - in pasta filata cheeses, 367–368
 - peptidases, 225–228
 - peptidases in cheese making and ripening, 228, 229
 - phage inhibitory media, 168, 180
 - phage-resistant cultures, 180, 181
 - pH control during propagation, 168, 170, 171
 - pheromones/sex factors, 271–273
 - phospholactolase pathway, 208, 210

- [Lactic acid bacteria (*see also* individual genera and species)]
- probiotics for livestock, 336–338
 - produce inhibitory compounds, 185–190
 - proteinase system, 222–224
 - protein metabolism, 222–228
 - protoplast fusion, 268, 269
 - pyruvate-alternative routes, 220–222
 - regulation of phosphotransferase system, 213, 216
 - replicative vectors, 278, 279
 - skyr, 318, 319
 - sour cream, 314, 315
 - spray-dried cultures, 173
 - streptococci, 154
 - in surface-ripened cheeses, 364
 - taxonomy, 153, 243, 244
 - transduction, 268
 - transformation, 276–280
 - villi, 318
 - ymer, 318
 - yogurt, 308–310
- Lactic acid production, 392
- Lactic acidosis, 31–32
- Lactobacillus*, 61, 67, 152–153 (*see also* individual species):
- adjunct culture, 191, 355, 370, 372
 - anaerobic waste treatments, 698
 - calcium lactate crystals, 379
 - characteristics of genus, 155–156
 - cheese ripening, 372
 - electroporation, 277
 - enumeration, 304
 - facultatively heterofermentative, 155, 372
 - galactose fermentation, 218
 - gas in cheese, 376
 - histamine formation, 498–499
 - homofermentative, 155
 - insertion sequence elements, 256
 - kefir, 317
 - lactose metabolism, 218
 - lactose permease, 211, 218
 - Middle Eastern fermented milks, 321
 - nutritional requirements, 167
- [*Lactobacillus*]
- obligately heterofermentative, 155
 - plasmids, 247
 - sex factor, 272
 - survive pasteurization, 353
 - taxonomy, 243
- Lactobacillus acidophilus*:
- acidophilus milk, 316–317
 - added to ice cream mix, 111
 - anticarcinogenic activity, 332
 - assimilates cholesterol, 111
 - beneficial for lactose maldigestors, 331–332
 - cold-shock proteins, 96
 - controls calf scours, 338
 - controls *Escherichia coli*, 329
 - controls *Helicobacter pylori*, 329
 - controls *Salmonella*, 328, 337
 - dahi, 319
 - deconjugates bile acids, 333
 - enumeration, 161
 - genome, 236
 - genome sequencing, 262
 - histamine production, 499
 - increases feed efficiency, 338
 - inhibit growth of organisms, 328
 - lactic acid production, 392
 - lactoperoxidase, 183, 306
 - probiotic, 303, 327
 - produces acidocin, 188
 - produces lactin, 188
 - reduces serum cholesterol, 333
 - sweet acidophilus milk, 317
 - yogurt, 165, 336
- Lactobacillus casei*:
- adjunct, 229
 - anticarcinogenic activity, 332
 - bacteriophage, 253, 264
 - cheese ripening, 372
 - controls diarrhea, 329
 - dahi, 319
 - enhances immune response, 330
 - enumeration, 304
 - facultatively heterofermentative, 155
 - fermented milk, 316
 - gas in cheese, 377

- [*Lactobacillus casei*]
 genetically modified, 193
 hypocholesterolemic activity, 334
 inhibits growth of organisms, 328
 lactic acid production, 392
 phosphotransferase system, 215, 218
 probiotic, 327
 produces caseicin, 188
- Lactobacillus casei* spp. *rhamnosum*, 389
- Lactobacillus delbrueckii* ssp. *bulgaricus*:
 added to ice cream, 111
 adjunct, 229
 anticarcinogenic activity, 332
 bacteriophage, 175
 beneficial for lactose maldigestors, 331
 dahi, 319
 enumeration, 160–161, 304
 frozen yogurt, 107, 108, 110
 galactose, not fermented, 219–220
 histamine production, 499
 homofermentative, 155, 208
 inactive against *E. coli* O157:H7, 457
 koumiss, 318
 lactic acid production, 392
 lactoperoxidase, 306
 lactose permease, 216
 Metchnikoff's theory, 327
 mozzarella cheese, 163
 Muenster cheese, 366
 Parmesan/Romano cheeses, 368
 pasta filata cheese, 367
 pH control during propagation, 168
 pink ring in cheese, 378
 produces lactacin, 188
 starter culture, 152
 survives freezing, 111
 Swiss and baby Swiss cheeses, 362
 yogurt, 164–165, 166, 309, 310
- Lactobacillus delbrueckii* ssp. *lactis*:
 bacteriophage, 175
 group I intron, 259
 homofermentative, 155
 starter culture, 152
- Lactobacillus gasseri*, transduction, 268
- Lactobacillus helveticus*:
 adjunct, 229
 dahi, 319
 galactose fermented, 216
 gas in cheese, 378
 histamine production, 499
 homofermentative, 155, 208
 lactic acid production, 392
 lactose permease, 216
 Leloir pathway, 219, 220
 mozzarella cheese, 163
 NIZO butter making method, 139
 Parmesan/Romano cheeses, 368
 pasta filata cheese, 367
 plasmids, 251
 polymerase chain reaction, 355
 produces helveticin, 188
 produces lactocin, 188
 starter culture, 152
 Swiss and baby Swiss cheeses, 362
 Swiss cheese, 164
- Lactobacillus kefir*:
 obligatory heterofermentative, 155
 in kefir cultures, 155, 317
- Lactobacillus kefirgranum*, 317
- Lactobacillus lactis*, Swiss and baby Swiss cheeses, 362
- Lactobacillus plantarum*:
 cheese ripening, 372
 gas in cheese, 377
 interaction with propionibacteria, 191
 produces pediocin, 189
- Lactobacillus rhamnosus*, added to ice cream, 111
- Lactobacillus reuteri*:
 added to ice cream, 111
 fermented milk, 317
 probiotic, 327
 produces reuterin, 329
- Lactobacillus sake*, plasmids, 251
- Lactobacillus salivarius*:
 transduction, 268
 controls salmonellae, 337

Lactococcus (see also individual species):

- bacteriophage, 177
- bacteriophage resistance, 178
- calcium lactate crystals, 379
- Colby and sweet brick cheese, 366
- description of genus, 153–154
- enumeration, 160–161, 304
- Havarti cheese, 366
- histamine formation, 498
- lactoperoxidase, 183
- Leloir pathway, 219
- Middle Eastern fermented milks, 321
- nutritional requirements, 167
- pH control during propagation, 168, 170–171
- pheromone, 272
- properties desired for Cheddar cheese, 162
- proteolytic enzymes, 153
- proteolytic system, 223
- sensitivity to sanitizers, 185
- sex factor, 272
- surface-ripened cheeses, 364
- Swiss cheese, 164
- tagatose pathway, 212
- taxonomy, 243

Lactococcus lactis:

- adjuncts, 229
- bacteriophages, 263–264
- blue mold cheese, 359
- casein source of nitrogen, 223
- chromosome maps, 261
- conjugation, 269–275
- electroporation, 277
- exopolysaccharide production, 253
- galactose metabolism repressed, 214
- genome, 236, 276
- genome sequencing, 262
- genome size, 261
- genomic analysis, 252
- group II intron, 260
- heterologous gene expression system, 267
- homofermentative, 208
- insertion sequence elements, 256

[*Lactococcus lactis*]

- interspecific polymorphisms, 262
- lac* operon, 215
- lactic acid production, 392, 393
- lactose metabolism gene, 215
- lactose phosphotransferase system, 211
- lost acid-producing ability, 246
- mating pair formation, 273
- misti doi, 320
- Parmesan/Romano cheese, 368
- phage resistance, 266–267, 270
- plasmids, 247, 251–252
- protoplast fusion, 269
- Swiss and baby Swiss cheese, 362
- temperate bacteriophage intron, 259
- theta plasmid replication, 251
- transduction, 268
- transposons, 257

Lactococcus lactis ssp. *cremoris*:

- bacteriophage, 175
- characteristics, 154
- Cheddar cheese, 366
- cold-shock proteins, 96
- cottage cheese, 356
- cream ripening, 138–139
- cultured buttermilk, 164, 312–313
- dahi, 319
- exopolysaccharide, 313
- genetically modified, 193
- genetic studies, 245
- inhibits enteropathogenic *E. coli*, 451
- little effect on *E. coli* 0157:H7, 457
- polymerase chain reaction, 355
- produces diplococcin, 188
- sour cream, 164
- viile, 318

Lactococcus lactis ssp. *hordniae*, 245

Lactococcus lactis ssp. *lactis*:

- adjunct culture, 191
- bacteriophage, 175
- characteristics, 154
- controls *E. coli* 0157:H7, 457
- cottage cheese, 356
- cream ripening, 138, 139
- cultured buttermilk, 164, 312–313

- [*Lactococcus lactis* ssp. *lactis*]
 dahi, 319
 exopolysaccharide synthesis, 236, 313
 gas in cheese, 377
 genetically modified, 193
 genetic studies, 245
 histamine formation, 499
 inhibits enteropathogenic *E. coli*,
 451
 produces lactacin, 188
 produces nisin, 188, 430
 sour cream, 164
- Lactococcus lactis* ssp. *lactis* biovar. *diacetylactis*:
 blue mold cheeses, 359
 characteristics, 154
 cottage cheese, 357–358
 cream ripening, 138–139
 cultured buttermilk, 164, 312
 dahi, 319
 diacetyl reductase, 314
 diacetyl synthesis, 230–231
 eye formation, 362
 floating curd, 358
 genetically modified, 193
 Havarti cheese, 366
 produces lactococcin, 188
 sour cream, 164
 villi, 318
 ymer, 318
- Lactococcus lactis* ssp. *lactis* biovar. *maltigenes*, 66, 143
- Lactose:
 fermented, 66
 synthesis, 8
 whey product, 386
- Lactose digestion:
 acidophilus milk beneficial, 331
 improved by probiotics, 330–332
Lactobacillus acidophilus beneficial,
 331–332
 lactose maldigestors, 330–331, 335
 yogurt beneficial, 331
- Lactose phosphotransferase system,
 211–213
 regulation, 213–216
- Lactosphaera*, 243
- Land application of dairy waste:
 application rates, 687
 bacteria and viruses removed, 688
 BOD removal, 686
 heterotrophic microorganisms, 685,
 687
 nitrification, 687–688
 nitrogen and phosphorus removal,
 687
 nitrogen uptake by plants, 687
 percolation capacity of soil, 686
 phosphorus, 687–688
 removal of microorganisms, 688
 soil bacteria, 685–686
- Lecane*, 692
- Leloir pathway, 219–220
- Leuconostoc* (see also individual species):
 bacteriophage, 177
 blue mold cheese, 359
 characteristics of genus, 154
 cottage cheese, 358
 diacetyl synthesis, 230
 electroporation, 277
 enumeration, 160, 161
 eye formation, 362
 gas in cheese, 376
 growth affected by milk composition,
 191
 Havarti cheese, 366
 insertion sequence elements, 256
 kefir, 317
 lactose permease, 211, 218
 Leloir pathway, 219
 nutritional requirements, 168
 plasmids, 247
 produce bacteriocins, 189
 sex factor, 272
 starter culture, 152
 taxonomy, 153, 243
- Leuconostock citrovorum*, 155
- Leuconostoc lactis*:
 characteristics, 155
 galactose fermented, 220
 Leloir pathway, 220

- Leuconostoc mesenteroides* ssp. *cremoris*:
 characteristics, 155
 cream ripening, 138–139
 cultured buttermilk, 164, 312
 dextran, 166
 sour cream, 164
 viili, 318
 ymer, 318
- Leuconostoc mesenteroides* ssp. *dextranicum*, produces dextrans, 189
- Leuconostoc mesenteroides* ssp. *mesenteroides*, produces mesenterocin, 189
- Leuconostoc paramesenteroides*, diacetyl synthesis, 230
- Lignin, 24
- Limburger cheese:
 botulism, 428
 flavor compounds, 365
 inoculum, 349
 manufacture, 364–365
 ripening, 365, 371
 smear, 365
 spread, 428
- Line sampling/testing, 659–660
- Listeria*, 94, 141:
 affected by bacteriocins, 187
 cheese, 397
 inhibited by lactacin, 188
 pasteurized milk, 652
- Listeria innocua*:
 butter, 142
 dairy plants, 94
- Listeria ivanovia*, causes infections, 458
- Listeria monocytogenes*, 117
 affected by bacteriocins, 186, 189
 blue mold cheeses, 361
 butter, 142, 146
 causes infections, 458
 characteristics of, 458, 459
 cheese, 399, 466, 674
 dairy plants, 94, 120
 growth in fluid milk products, 72, 73
 hazard component in HACCP, 599
 ice cream, 117
- [*Listeria monocytogenes*]
 inhibited by carbon dioxide, 358
 inhibited by leuconostoc bacteriocins, 189
 inhibited by pediocin, 189
 Limburger cheese, 365
 low fat spreads, 148
 mastitis, 40
 methods to isolate and detect, 459
 milk and milk products, 60
 milk quality affected, 61
 monitoring, 145
 pathogens shed into milk, 61
 psychrotrophic, 60
 raw milk, 61, 98
 recalls of products, 399, 458
 resistant to cold temperatures, 96, 118
 sources in raw milk, 98
 zero tolerance, 458
- Listeria seeligeri*, causes infections, 458
- Listeriosis:
 outbreaks, 460–463
 prevention, 465
 susceptible segments of population, 460
 symptoms, 460
 treatments, 460
- Mad cow disease (*see* Bovine spongiform encephalopathy)
- Malted milk powder, *Bacillus cereus*
 food poisoning, 422
- Margarine:
 definition, 146
 manufacture, 147
 spoilage, 148
- Mastitis:
 antibiotics to treat, 442
 bovine somatotropin, 41
 causative agents, 40
 chronic, 41
 clinical, 38
 contagious, 39
 environmental, 39
 milk composition changed, 40–41
 subclinical, 39

Megasphaera elsdenii, 26, 31–32, 36
Melissococcus, 243
Methanobreveibacter smithii, 27
 Methanogenic bacteria, 698
 Mexican cheese, brucellosis, 433, 435
 Mexican-style cheese:
 listeriosis, 461
 salmonellosis, 474
Microbacterium, 61, 353
 Microbiological testing—fluid milk products:
 coliform count, 664
 sensory evaluation at end of shelf-life, 667
 sensory evaluation of fresh product, 667
 shelf-life prediction tests, 666–667
 Microbiological testing—future of, 675–677
 Microbiological testing—ingredients, 658
 Microbiological testing—raw milk and ingredients:
 adenosine triphosphate bioluminescence, 657
 aerobic plate count, 656, 659
 coliforms, 657, 659
 direct microscript count, 656, 659
 preliminary incubation, 657, 659
 psychrotrophic estimates, 656
 ropy milk test, 646–647
 tests on each tanker of milk, 646
Micrococcus, 61, 85, 105–106, 158, 353, 365
Micrococcus caseolyticus, 365
Micrococcus freudenreichii, 365
 Microfiltration, 71
 Microgard, 190, 358
 Middle Eastern cultured milks:
 kishk, 321
 laban khad, 321
 laban rayab, 321
 laban zeer, 321
 labneh, 321
 zabady, 321

Milk:

aflatoxin, 6, 7, 414–418
 agglutinins, 182–184
 antibiotic residues, 6, 351
 antibiotics in, 184–185, 305
Bacillus cereus food poisoning, 418–424
 bacterial testing, 63–66
 biosynthesis, 7–8
 botulism, 424–430
 brucellosis, 430–435
 campylobacteriosis, 435–441
 casein attacked by psychrotrophs, 655
 casein degraded, 222
 casein micelles, 348–349
 certified, 397, 613
 cheese quality, 350, 351
Citrobacter freundii, 495
 clarification, 351
 cleaning procedures, 562–564
 colostrum, 7
 composition, 8–9, 347
 composition affects starter cultures, 191
 compositional tests, 649
 composition and rumen fermentation, 35–37
 concentrated and dry milk products, 77
 contamination sources, 61–62, 350–351
 control of microorganisms in, 68–72
Corynebacterium ulcerans, 495
 Creutzfeldt-Jakob disease, 495–496
 cryptosporidiosis, 496–497
 diphtheria, 404–405
 drug residues, 442–447
 encephalitis (tickborne), 504
 enterohemorrhagic *Escherichia coli* 0157:H7, 452–458
 enteropathogenic *Escherichia coli*, 447–452
 flavored products, 72, 461
 flow diagram, 610
 future of microbiological testing, 675–677

[Milk]

grade A, 615
 HACCP description chart, 611
 Haverhill fever, 497–498
 hazard analysis chart, 608–609
 heat treatment, 352–353
 illnesses, 397
 infectious hepatitis, 499–500
 inhibitors of starter cultures, 182–184, 305–306
 Johne's disease, 500
 lactoferrin, 182, 184
 lactoperoxidase system, 182–183, 306
 legal definition, 5
 listeriosis, 458–465
 lysozyme, 182, 184
 manufacturing grade, 77, 615, 635
 microflora, 59, 649–656
 mycotoxins, 500–501
 Pasteurized Milk Ordinance, 620–623
 pathogens in, 60, 613
 postpasteurization contamination, 62–63
 precursors, 8
 production of, 397
 Q-fever, 501–502
 quality affected by bacterial growth, 66–68
 quality affected by mastitis, 351
 quality tests, 645–648
 raw-bacterial standards, 6, 63, 350
 rosy, 646–647
 salmonellosis, 465–478
 scarlet fever/septic sore throat, 406
 sediment, 62
 shelf-life predicting tests, 660–664
 shigellosis, 502, 503
 spoilage, 61
 standardization, 351
 staphylococcal poisoning, 478–486
Streptococcus zooepidemicus, 503
 toxoplasmosis, 504–505
 tuberculosis, 407–408
 typhoid fever, 410–413
 unflavored products, 72–73
 yersiniosis, 486–494

Milkfat:

anticarcinogenic activities, 37
 butyric acid, 37
 conjugated linoleic acid, 37
 synthesis, 9

Milk hauler:

certified for milk sampling, 630
 hauler report, 631

Milk protein:

synthesis, 9
 precipitation, 66

Milk shake, campylobacteriosis, 440

Mimosine poisoning, 35, 37

Mold-ripened cheese (*see also* individual varieties), typhoid fever, 412Molds (*see also* Fungi):

butter, 141, 143, 669
 cause cheese defects, 374
 cheese ripening, 354
 cheese spoilage, 350
 cottage cheese, 358
 cultured dairy products, 674
 frozen dairy desserts, 669
 fruit, 101, 103
 milk and milk products, 60
 mycotoxin production, 6
 pasteurized cream, 146
 potassium sorbate, 358, 374
 raw milk, 61
 spoilage of milk, 66
 syrups, 100
 toxigenic products recalled, 403
 water activity, 143

Moniliformin, 501

Mozzarella cheese:

baking, 368
 defects, 368
 desirable properties of starter cultures, 163
 galactose present, 217, 219
Listeria monocytogenes, 465
 low galactose, 217, 220
 manufacture, 367
 mesophilic starter, 354
 nonenzymatic browning, 217

- [Mozzarella cheese]
 pasteurized milk, 352
 proteolysis, 163
Salmonella, 476–477
 slits, 376
Staphylococcus aureus, 486
 starters, 211
- Mucor*, 101, 374, 501
- Muenster cheese:
 description, 365
 flavor development, 235
 manufacture, 366
 reduced fat, 370
 ripening, 366
 survival of *Mycobacterium bovis*, 409
- Mycobacterium*:
 cause tuberculosis, 41
 description, 42, 43
- Mycobacterium avium*, 406
- Mycobacterium bovis*:
 bovine tuberculosis, 42
 characteristics, 43
 dairy products, 409
 description of, 406–407
 human infections, 42
 milk and milk products, 60
 milkborne transmission, 408
 raw milk, 408
 reservoirs, 42
 survival in cheese, 409
 wild animals, 409
- Mycobacterium paratuberculosis*:
 Crohn's disease, 500
 description of, 44, 500
 heat resistance, 500
 Johne's disease, 43, 500
 milk and milk products, 60
- Mycobacterium pseudotuberculosis*, 500
- Mycobacterium tuberculosis*:
 characteristics, 43, 407
 isolated in 1882, 41
 milk and milk products, 60
 raw milk, 61
- Mycophenolic acid, 501
- Mycoplasma bovis*, 61
- Mycoplasma* spp., mastitis, 40
- Mycotoxins, 6 (*see also* individual toxins)
 hazard component in HACCP, 599
 nuts, 104
 produced by various molds, 501
- Natamycin, 374
- National Conference on Interstate Milk Shipments:
 agreement with FDA, 616
 biennial conference, 618–620
 councils, 618–619
 executive board, 617–618
 General Assembly, 619
 proposals to FDA, 619
- National Milk Producers Federations, 620
- Neocallimastix frontalis*, 18
- Neufchâtel cheese, botulism, 428
- Nisin:
 controls *Clostridium botulinum*, 430
 dahi, 320
 evaporated milk additive, 82
 ice cream additive, 118
 milk preservative, 72
 process cheese, 370
 transposons, 257–258
- Nitrification, 687–688, 694, 696
- Nitrobacter* sp., 687, 694
- Nitrosomonas* sp., 687, 694
- NIZO butter making method, 138
- Nonfat dry milk (*see* Dry milks)
- Norwalk virus, dairy-related illness, 398
- Nostocoida limicola*, 695
- Notommata*, 692
- Novelties, frozen, 113
- Nutrition Labeling and Education Act of 1990, 638
- Nuts, 103
 hazelnut conserve, botulism, 429
- Occupational Safety and Health Administration, 640
- Oenococcus*, 243, 247, 261, 272
- Official Methods of Analysis*, 118, 630

- Oligosaccharides:
 enhance growth of *Bifidobacterium*, 339
 fructo-oligosaccharides, 339
 galacto-oligosaccharides, 339
 inulin, 339
 prebiotics, 338, 339
- Omasum, 4
- Opercularia*, 692
- Oxalate poisoning, 34, 35
- Oxalobacter formigenes*, 35
- Packaging:
 butter, 141
 receiving and storage, 591
- Parasites:
 dairy-related illness, 398
 hazard component in HACCP, 599
- Paratuberculosis (*see* Johne's disease)
- Parmesan cheese:
 aflatoxin, 418
 defined, 368
 flavor, 229
 lipase, 369
 manufacture, 368
 molds, 374
 pink ring, 378
- Pasteurella X*, 487
- Pasteurization:
 cleaning/sanitizing of equipment, 566
Coxiella burnetii, 68
 cream for butter making, 135, 138
 denounced, 398
 destroys psychrotrophic bacteria, 97
 effectiveness, 352
 frozen dessert mixes, 114
 heating methods, 70
 laminar flow, 114
 purpose, 68
 required for some cheese milk, 352
 Reynolds number, 114
 times and temperatures, 69
- Pasteurized milk (*see also* Milk):
 cheese making, 352
 process cleaning procedures, 564
 spoilage, 61
- Pasteurized Milk Ordinance, 6, 63, 65, 69
 adopted by states and territories, 620
 bacteriological and other standards, 622
 history, 614, 615
 losing grade A status, 620
 National Conference on Interstate Milk Shipments, 615–620
 organizations and contents, 621
 regulating document, 620
 related documents and programs, 623, 630, 634–635
 role of national associations, 620
- Patulin:
 produced by *P. carneum*, 160
 produced by *P. paneum*, 160
 produced by *P. roqueforti*, 501
- Pectic materials, 22–24
- Pectin gel plate count, 64
- Pediococcus*:
 bacteriophage, 177
 calcium lactate crystals, 379
 in cheese, 244
 genetically modified, 193
 sex factor, 272
 taxonomy, 243
- Pediococcus pentosaceus*, plasmids, 251
- Penicillic acid, 501
- Penicillium*, 101, 143, (*see also* individual species)
 characteristics of genus, 160
 cheese flavor, 160, 235
 cheese spoilage, 374
 mycotoxins, 160, 501
 nitrification, 687
- Penicillium camemberti*:
 adjunct culture, 191
 Camembert/Brie cheese, 160, 235, 361–362
 cyclopiazonic acid, 160, 501
 metabolism, 235, 362
- Penicillium carne*:
 produces patulin, 160
 related to *P. roqueforti*, 160

- Penicillium caseicolum*, Camembert/
 - Brie cheese, 160
- Penicillium commune*:
 - cheese contaminant, 160, 374
 - toxin producer, 160
- Penicillium glaucum*, 359
- Penicillium paneum*:
 - produces botryodiplodin, 160
 - produces patulin, 160
- Penicillium roqueforti*:
 - blue-veined cheeses, 235, 359
 - metabolism, 235, 360
 - mycotoxins produced, 501
- Peptidases, 225–228
 - aminopeptidases, 226–228
 - dipeptidases, 226–227
 - endopeptidases, 226–227
 - exopeptidases, 226
 - tripeptidases, 226–227
- Peptostreptococcus anaerobius*, 29
- Peracetic acid sanitizers, affect starter cultures, 185
- Peroxyacetic acid sanitizers:
 - advantages, 576
 - disadvantages, 576
 - properties, 576
- Personnel training—HACCP:
 - access controlled, 594
 - hand washing, 593
 - personal cleanliness, 594
 - production personnel, 593, 607
 - senior management, 607
 - team members, 606
- Petrifilm aerobic count, 64, 119
- Pheromones, 271–272
- Philodina*, 692
- Phosphated whey medium, 389
- Phosphoketolase pathway, 208, 210
- Pichia*, 99, 375
- Plant toxicoses:
 - grass tetany, 33–34
 - mimosine poisoning, 35, 37
 - oxalate poisoning, 34–35
- Plasmid:
 - DNA, 245–252
 - encoded properties of lactics, 248–249
 - [Plasmid]
 - replication, 246–252
 - rolling circle replication, 247–251
 - theta replication, 251–252
- Plate loop count, 64
- Polioencephalomalacia, 33
- Polymerase chain reaction, 120, 355
- Ponds/lagoons to treat dairy wastes:
 - aerobic ponds, 689
 - anaerobic ponds, 690
 - facultative ponds, 689
 - microbial activities, 689
- Potassium sorbate:
 - butter, 145
 - cold-pack cheese, 371
 - cottage cheese, 358
 - E. coli* 0157:H7, 457
 - mold control, 374
 - source of 1,3-pentadiene, 374
- Prebiotics:
 - enhance growth of *Bifidobacterium*, 339
 - inulin, 339
 - oligosaccharides, 338–339
- Preliminary incubation count, 65–66
- Prerequisite program—HACCP
 - equipment performance and maintenance, 592
 - personnel training, 593–594
 - premises, 588–591
 - recalls, 595–597
 - receiving and storage, 591–592
 - review existing programs, 588
 - sanitation, 594–595
- Prevotella ruminicola*, 24, 28–29
- Prion, 495
 - causes bovine spongiform encephalopathy, 48
 - defined, 48
- Probiotics:
 - anticarcinogenic properties, 332
 - antimicrobials produced, 329
 - bacteria, 36
 - bacteriocins produced, 329
 - benefits to consumers, 110, 328–335
 - bifidobacteria, 159

[Probiotics]

- Bifidobacterium*, 302, 303, 327
 - characteristics needed by cultures, 335–336
 - competitive exclusion, 330, 337
 - controlling undesirable intestinal organisms, 328, 337
 - controls serum cholesterol, 333
 - enterococci, 158
 - food supplements, 111
 - for cattle, 36, 37
 - frozen yogurt, 93
 - health claims, 335
 - improvement of immune response, 330
 - improvement of lactose digestion, 330–332
- Lactobacillus acidophilus*, 303, 327
- Lactobacillus reuteri*, 327
 - livestock, 336, 337
- Streptococcus thermophilus*, 327
 - yeast, 36, 327, 337–338
 - yogurt, 303, 327
- Process cheese:
 - contaminants, 370
 - defined, 370
- Propionate pathway, 234
- Propionibacterium* (see also individual species):
 - bacteriophage, 177
 - characteristics of genus, 157
 - differentiation of species, 157
 - enumeration, 161
 - gas in cheese, 376–377
 - histamine formation, 499
 - interaction with lactobacilli, 191
 - metabolism, 233–234
 - probiotic, 327
 - propionate pathway, 234
 - used to make cheese, 337
- Propionibacterium acidipropionici*, characteristics, 157
- Propionibacterium freudenreichii* ssp. *freudenreichii*:
 - characteristics, 157
 - propionic acid production, 393
 - used in cheese making, 157
- Propionibacterium freudenreichii* ssp. *shermanii*:
 - adjunct culture, 191
 - characteristics, 157
 - eye formation, 362
 - metabolism, 233–234
 - Swiss cheese, 164, 233
 - used in cheese making, 157
 - used to produce Microgard, 190, 358
- Propionibacterium jensenii*:
 - characteristics, 157
 - produces jensenin, 189
 - spots on cheese, 378
- Propionibacterium thoenii*:
 - characteristics, 157
 - produces propionicin, 189
 - spots on cheese, 378
- Propionic acid production, 393
- Protein metabolism—lactic acid bacteria:
 - amino acid transport system, 224–225
 - amino peptidases, 226–228
 - dipeptidases, 226–227
 - endopeptidases, 226–227
 - exopeptidases, 226
 - peptidases, 225
 - peptide transport system, 224–225
 - proteinase system, 222–224
 - role in cheese making and ripening, 228–229
 - tripeptidases, 226–227
- Proteus*, 106
- Protozoa:
 - activated sludge waste treatment, 691
 - benefits, 18
 - cryptosporidiosis, 496–497
 - entodiniomorphs, 17–18
 - faunated/defaunated animals, 17–18
 - fermentative metabolism, 17
 - grazing on bacteria, 18
 - holotrichs, 17
 - in milk and milk products, 60
 - oligotrichs, 17
 - in rumen, 17–18
 - toxoplasmosis, 504–505

- Provolone cheese:
 lipase, 367
 manufacture, 367
 ripening, 371
- Pseudomonas*, 61, 73, 98, 101, 105–
 106, 141, 314, 350–351, 356, 358,
 360, 364, 375, 649, 664, 685, 690,
 696
- Pseudomonas aeruginosa*, milk and
 milk products, 60–61
- Pseudomonas fluorescens*, 61, 67, 72,
 96, 143
 cottage cheese contaminant, 357
 inhibited by propionicin, 189
 monoclonal antibodies, 664
- Pseudomonas fragi*, 61, 67, 143, 357
- Pseudomonas mephitica*, 143
- Pseudomonas nigrificiens*, 143
- Pseudomonas putida*, 61, 67, 105, 357
- Pseudomonas putrefaciens*, 61, 67, 143
- Psychrophilic bacteria, 654
- Psychrotrophic bacteria:
 in butter, 141, 143
 Cheddar cheese defects, 654
 contaminants of starter cultures, 314
 cottage cheese contaminants, 357, 668
 in cream, 138
 cultured dairy products, 674
 defined, 59, 652
 in flavored milks, 72
 fluid milk products, 665
 frozen dairy desserts, 669
 heat-stable enzymes, 67, 655
 inhibited by starter cultures, 72
 monitoring, 654
 off-flavors in cultured buttermilk, 314
 pathogens in milk and milk products,
 60
 proteases attack casein, 655
 raw milk, 61–62, 65, 98, 351, 652
 shelf-life indicators, 661, 663
 sources, 654
 spore formers, 67, 137
- Psychrotrophic plate count, 68, 72, 120,
 647, 669
- Public Health Service Act, 614
- Pure Food and Drug Act of 1906, 614
- Pyruvate metabolism, alternative routes,
 221–222, 236
- Q-fever:
 raw milk, 502
 symptoms, 501
- Quaternary ammonium sanitizers:
 advantages, 575
 affect starter cultures, 185, 305
 disadvantages, 575
 properties, 574
- Queso blanco cheese:
 defects, 350
 manufacture, 350
Streptococcus zooepidemicus, 504
- Recalls:
 cheese, 458
 cheese and cheese products, 95, 399
 classes, 639
 defined, 117, 639
 ice cream and frozen yogurt, 95, 458
L. monocytogenes-related, 458
 number for dairy foods, 403
 regulatory agency, 596
 role of FDA, 639, 640
 types, 639
 voluntary, 399, 639
 written procedure, 595
- Receiving and storage plant areas:
 incoming materials, 591
 packaging material, 591
 raw materials, ingredients, 591
 return or damaged product, 592
 storage and transport conditions, 592
- Reduced fat cheeses:
 flavor, 370
 manufacture, 369
 ripening, 370, 372
- Refrigeration, 68
- Regulatory controls (*see also* Dairy reg-
 ulations):
 cheese milk, 352
 ice cream, 116–118
 sanitizers, 564, 567

- Reindeer, 2
- Reticulum, 4
- Reverse osmosis, whey, 88
- Rhizopus*, 101, 143
- Ricotta cheese:
 - defects, 350
 - manufacture, 350
- Romano cheese:
 - defined, 368
 - manufacture, 368
 - pink ring, 378
 - ripening, 371
- Roquefort cheese:
 - flavor, 160, 235
 - mycotoxins, 501
 - penicillia, 160, 359
 - sheep milk, 359
- Roquefortine, 501
- Rotavirus, dairy-related illness, 398
- Rotifers, 692
- Rumen:
 - bacteria in, 12, 14, 15
 - bacterial adaptation, 13
 - bacterial characteristics, 14–15
 - bacterial populations, 13
 - bacteriophages in, 18
 - butyric acid, 37
 - carbohydrate fermentation in, 16
 - carbohydrates, nonstructural, 24–25
 - carbohydrates, structural, 19–24
 - chemical/physical conditions, 11
 - conjugated linoleic acid, 37
 - contents, 5
 - description, 4
 - dysfunction, 31–33
 - environment within, 10–12
 - faunated/defaunated animals, 17–18
 - fermentation and milk composition, 35–37
 - fermentation endproduct ratios controlled, 36
 - fermentations in, 19–30
 - fiber digestion increased, 35
 - fistula, 11
 - function, 5
 - fungi in, 18, 19
- [Rumen]
 - hydrogen transfer, 26
 - microbial growth yield, 30–31
 - microbial population, 12
 - microbial protein, 30
 - microbiological methods, 9–10
 - microbiology, 9–19
 - nitrogen metabolism, 28–31
 - probiotics, 36
 - protein degradation, 28, 29
 - protein digestion reduced, 36
 - protein synthesis, 29, 30
 - protozoa in, 17, 18
 - ruminal H₂ redirected, 36
 - volatile fatty acid production, 25–26
- Rumen dysfunction:
 - foamy bloat, 32–33
 - lactic acidosis, 31–32
 - polioencephalomalacia, 33
- Ruminant animal, essential feature, 1
- Ruminobacter amylophilus*, 24
- Ruminococcus*, 24
- Ruminococcus albus*, 20, 22–23, 27
- Ruminococcus flavefaciens*, 20, 22–23

- Saccharomyces*, 101 (*see also* individual species)
- Saccharomyces cerevisiae*, 392
- Saccharomyces kefir*, 317
- Salmonella* (*see also* individual species):
 - butter, 146
 - characteristics, 467
 - cheese, 399, 445, 476–477, 674
 - colorants, 106
 - controlled by lactobacilli, 328, 337
 - dairy plants, 94
 - hazard component in HACCP, 599
 - methods to isolate and detect, 468
 - milk and milk products, 60
 - monitoring, 145
 - pasteurization inactivates, 475
 - pasteurized cream, 146
 - pasteurized milk, 652
 - in raw milk, 61, 474
 - shed in feces of cattle, 474

[*Salmonella* (see also individual species)]

- survives spray drying, 85, 87
- syrup, 100

Salmonella Cholerae-suis, 467*Salmonella* Dublin:

- cheese, 474
- colonize udder, 474
- hazard component in HACCP, 599
- infect bovine mammary gland, 473
- in raw milk, 97

Salmonella Enteritidis, 95, 96

- classification, 467
- cold-shock proteins, 96
- controlled by *Lactobacillus salivarius*, 337
- eggs, 105, 106
- ice cream-associated salmonellosis, 118, 399, 475

Salmonella Heidelberg, 467, 473*Salmonella* Javiana, 474*Salmonella* Muenster, 473, 474*Salmonella* Newbrunswick, 472*Salmonella* Oranienburg, 106, 474*Salmonella* Paratyphi:

- dairy products, 410
- hazard component in HACCP, 599

Salmonella Senftenberg 775W, 475*Salmonella* Typhi:

- carriers of, 412
- description of, 410
- hazard component in HACCP, 599
- pasteurization, 413
- shedding, 411
- survival in dairy foods, 413

Salmonella Typhimurium:

- antibiotic-resistant strain, 445, 472
- classification, 467
- failed to survive pasteurization, 87
- outbreak, 472
- strain DT104, 474

Salmonellosis:

- cheese, 473–474
- clinical confirmation, 469
- epidemic, 399
- excretion of salmonellae, 468
- gastroenteritis, 468

[Salmonellosis]

- history, 465, 467
- ice cream, 399, 473, 475
- localized tissue infections, 469
- major public health concern, 398
- nonfat dry milk, 472, 475
- outbreaks, 467, 469–474
- pasteurized milk, 397, 472
- prevention, 478
- septicemia, 469
- symptoms, 468

Sanitation ratings of milk supplies, 634

Sanitizer activity—factors affecting:

- concentration, 578
- condition and number of organisms, 579–580
- hard water, 579
- incompatible compounds, 580
- organic matter, 578
- pH, 579
- physical condition of surface, 580
- residual activity, 581
- stability of product, 579
- temperature, 578
- time of exposure, 578
- type of organism, 579
- wetting ability, 579

Sanitizer efficacy validation:

- ATP, 582
- microbiological, 582
- performance monitoring, 582
- RODAC plating, 582
- visual, 581

Sanitizers:

- acid-anionic surfactants, 575
- application, 581
- approved sanitizing solutions, 568–570
- chlorine and chlorine compounds, 571–573
- factors affecting activity, 578–581
- fatty acid sanitizers, 575–576
- governmental regulations, 564–565
- hot water, 576–577
- iodophors, 573–574
- label directions, 567, 594

- [Sanitizers]
 - peroxyacetic acid, 576
 - quaternary ammonium compounds, 574–575
 - terms defined, 567
 - ultraviolet irradiation, 577–578
 - validation of efficacy, 581–582
- Sarcina*, 85
- Scandinavian cultured milks:
 - ropy texture, 154
 - skyr, 318, 319
 - villi, 318
 - ymer, 318
- Scarlet fever:
 - outbreaks, 405–406
 - raw milk, 397–399, 613
 - symptoms, 405
- Schizosaccharomyces*, 99
- Scopulariopsis*, 374
- Selenomas ruminantium*, 25, 26, 31–32, 34, 36
- Septic sore throat, 405, 406
- Serratia marcescens*, 67
- Sheep, 2, 6
 - infected by *Brucella melitensis*, 44
 - infected by *Brucella ovis*, 44
- Sheep's milk cheese:
 - brucellosis, 433
 - encephalitis (tickborne), 504
 - staphylococcal poisoning, 473
- Shelf-life predicting tests:
 - attributes of rapid test, 662–663
 - correlated with product shelf life, 661
 - fluid milk products, 666–667
 - methods, 661–663
 - shelf life/keeping quality defined, 660
- Sherbet:
 - composition, 112
 - freezing, 96
- Shigella*:
 - bacillary dysentery, 502
 - hazard component in HACCP, 599
- Shigella boydii*, 502
- Shigella dysenteriae*:
 - bacillary dysentery, 502
 - hazard component in HACCP, 599
 - vero cytotoxin, 502
- Shigella flexneri*, 502
- Shigella sonnei*, 502–503
- Shigellosis
 - cheese, 503
 - raw milk, 503
 - symptoms, 502
- Sodium benzoate, butter, 145
- Soft-ripened cheese, numerous outbreaks of illness, 399
- Soft-unripened cheese, brucellosis, 433
- Soils (on dairy equipment):
 - carbohydrates, 549
 - lipids, 548
 - minerals, 549
 - other, 549, 550
 - proteins, 548
- Soluble sugars/oligomers, 25
- Somatic cell count, 68
 - affects cheese making, 68
 - standards, 648
- Somatic cells, 67, 68, 351
- Sorbet:
 - contamination with milk protein, 112
 - freezing, 96
 - manufacture, 112
- Sour cream:
 - coliform survival in, 673, 674
 - defects, 315
 - description, 314
 - desirable properties of starter cultures, 164
 - E. coli* O157:H7 survival in, 457
 - low-fat and fat-free types, 314–315
 - manufacture, 315–316
 - starter cultures for, 314–315
- Sphaerotilus*, 695, 696
- Spices, 107
- Spiral plate count, 64
- Spreads:
 - full fat, 146
 - low fat, 146
 - reduced fat, 146
 - spoilage, 148
 - very low fat, 146

- Standard Methods for the Examination of Dairy Products*, 82, 85, 89, 118, 119, 304, 630, 657, 658, 665, 668, 669, 670, 671, 673, 674
- Standard plate count, 64, 66, 68, 72, 116, 119, 120, 647, 653, 669, 670
- Standards for fabrication of single-service containers and closures, 630
- Staphylococcal enterotoxin:
 detection, 481
 heat stable, 478
 pasteurized cream, 135
 produced by species other than *S. aureus*, 480
 production, 478–479
- Staphylococcal food poisoning:
 butter, 142–143
 dairy foods involved, 478
 dry milks, 85
 major public health concern, 398
 outbreaks, 481–484
 prevention, 486
 symptoms, 481
- Staphylococci, coagulase-negative, 61, 480
- Staphylococcus*, 64
 Camembert/Brie cheeses, 362
 cheese, 675
 inhibited by lacticin, 188
 Limburger cheese, 365
- Staphylococcus aureus*:
 blue mold cheese, 360
 butter, 142, 146
 characteristics, 479, 480
 cheese, 399, 445, 674
 enterotoxin detection, 481
 enterotoxin production, 478–479
 hazard component in HACCP, 599
 mastitis, 40
 methods to isolate, detect and identify, 480–481
 milk and milk products, 60
 monitoring, 145
 occurrence and survival in dairy foods, 484–486
 raw milk, 61, 62
 virulence, 41
- Staphylococcus hyicus*, 480
- Staphylococcus intermedius*, 480, 482
- Starch, 24
- Starter cultures (*see also* individual genera and species)
 acid curd cheese, 349
 acidophilus milk, 316–317
 activity tests, 190–191
 adjunct cultures, 191–192
 antibiotics in milk, 184–185, 305, 445
 artisanal, 354
 bacteriophages, 173–182, 305
 bifidobacteria, 158, 159
 blue mold cheese, 359
 brevibacteria, 158, 234–236
 Camembert/Brie cheeses, 361
 characteristics of bacteriophage infection, 179
 Cheddar cheese, 366
 cheese ripening, 371–372
 cheeses with eyes, 362–364
 chemical sanitizers, 185, 305
 choice of, 353
 Colby and sweet brick cheeses, 366
 commercial preparations, 171–173
 contaminated, 314
 cottage cheese, 356, 358
 cultured buttermilk, 312–313
 dahi, 319
 description, 152
 desirable properties, 162–167
 enterococci, 158
 enumeration, 160–162, 303–305
 facilities to handle, 305
 for cheese making, 353–354
 genetically modified, 192–194
 growth media formulations, 168–169
 history, 151
 incubation conditions, 171
 inhibit *S. aureus*, 485
 inhibitors in raw milk, 182–184, 306
 interactions of cultures, 191–192
 kefir, 317
 koumiss, 317–318
 lactic, 152
 lactobacilli, 155–157
 lactococci, 153–154

- [Starter cultures (*see also* individual genera and species)]
- leuconostoc, 154–155
 - mesophilic lactic, 152, 353–354
 - misti doi, 320
 - Muenster and Havarti cheeses, 366
 - Parmesan/Romano cheeses, 368
 - pasta filata cheeses, 367
 - penicillia, 160, 234, 235
 - pH control during propagation, 168, 170–171
 - phosphated whey medium, 389
 - preventing bacteriophage infection, 179–182
 - produce inhibitory compounds, 185–190
 - propagation, 167–171
 - propionibacteria, 157
 - skyr, 318–319
 - sour cream, 314–315
 - streptococci, 154
 - surface-ripened cheeses, 364–365
 - thermophilic lactic, 152
 - viili, 318
 - ymer, 318
 - yogurt, 308–310
- Sterigmatocystin, 501
- Stilton cheese:
- flavor, 160
 - penicillia, 160, 359
- Streptobacillus moniliformis*:
- causes Haverhill fever, 497
 - description of, 497
- Streptococcus*, 61, 64, 67, 85, 153–154, 188, 243, 353, 698 (*see also* individual species)
- plasmids, 247
- Streptococcus agalactiae*, 39, 40
- eradication test, 65
 - mastitis, 40
 - milk and milk products, 60–61
- Streptococcus bovis*, 24–25, 28, 31–32
- Streptococcus dysgalactiae*, 61–62
- Streptococcus faecalis*, 158
- Streptococcus faecium*, 158
- Streptococcus mutans*, 246, 262
- Streptococcus pneumoniae*:
- genome sequencing, 262
 - group II intron, 260
- Streptococcus pyogenes*:
- description of, 405
 - genome sequencing, 262
 - milk and milk products, 60
 - scarlet fever/septic sore throat, 405–406
- Streptococcus salivarius*, 154
- Streptococcus thermophilus*:
- added to ice cream, 111
 - antibiotic sensitivity, 184
 - bacteriophage(s), 177, 263–264
 - benefits lactose maldigestors, 331
 - Camembert/Brie cheeses, 361
 - characteristics, 154
 - chromosome map, 261
 - cold-shock proteins, 96
 - dahi, 319
 - electroporation, 277
 - enumeration, 160–161, 304
 - exopolysaccharide, 108–109, 253
 - frozen yogurt, 107–110
 - galactose efflux, 217, 219
 - gas in cheese, 378
 - genome sequencing, 262
 - homofermentative, 208
 - insertion sequence elements, 256
 - intraspecific polymorphisms, 262
 - lactoperoxidase, 183, 306
 - lactose permease, 211, 216
 - lactose transport and hydrolysis, 216–218
 - Leloir pathway genes, 220
 - little effect on *E. coli* 0157:H7, 457
 - misti doi, 320
 - mozzarella cheese, 163
 - Muenster cheese, 366
 - nutritional requirements, 167
 - Parmesan/Romano cheeses, 368–369
 - pasta filata cheeses, 367
 - pH control during propagation, 168
 - phage resistance, 266
 - phage with group I intron, 259
 - plasmids, 246, 247

- [*Streptococcus thermophilus*]
 possible galactose fermentation, 236
 probiotic, 327
 produces thermophilin, 189
 sex factor, 272
 starter culture, 152
 Swiss and baby Swiss cheeses, 164, 362
 transduction, 268
 transposons, 258
 used with lactobacilli, 157
 yogurt, 164–167, 309–310
- Streptococcus uberis*, 61–62
- Streptococcus zooepidemicus*:
 fresh cheese, 504
 mastitis, 503
 milk and milk products, 60
 raw milk, 503
 symptoms of illness, 503
- Succiniclasticum ruminis*, 25
- Succinivibrio dextrinosolvens*, 24
- Succinomonas amylolytica*, 24
- Surface-ripened cheeses:
 botulism, 429
Brevibacterium linens, 158
 flavor, 158
 Limburger, 349
 listeriosis, 463
- Surfactants:
 amphoteric, 556
 anionic, 555–556
 cationic, 555–556
 hydrophilic-lipophilic balance, 555
 nonionic, 556
- Sweetened condensed milk, 77
 ice cream ingredient, 98
 manufacture, 79
 spoilage, 79
 uses, 79
- Sweeteners:
 syrups, 99
 honey, 100
 microbial standards, 100
- Swiss cheese:
 aflatoxin, 418
Brucella abortus in, 435
Campylobacter survival, 441
- [Swiss cheese]
 defect, 364
 desirable properties of starter cultures, 163–164
 eye formation, 164, 233, 363
 flavor, 229, 233
 flavor development, 164
 galactose use, 164
 histamine poisoning, 499
 manufacture, 233, 363
 mesophilic starter, 354
 pink ring, 378
 ripening, 363
 spots, 278
 staphylococcal poisoning, 483
Staphylococcus aureus, 486
 starters, 211
 toxigenic molds, 501
 typhoid fever, 413
- Synergistes jonesii*, 35
- Syrups:
 Brix, 99
 condensate, 99
 corn sweeteners, 99
 dextrose equivalent, 99
 osmophilic yeasts and molds, 99
 osmotolerant yeasts, 99
- Tagatose pathway, 212
- Tetragenococcus*, 243, 246
- Tetragenococcus halophilus*, plasmids, 251
- Thermal death rate curve, 70
- Thermal death time curve, 70, 353
- Thermal resistance—microorganisms:
 medium composition, 70
 numbers of organisms, 71
 pH, 70
 thermal buffer, 71
 water activity, 70
- Thermoduric bacteria:
 low-fat spreads, 147
 processed products, 65
 raw milk, 61
 survive pasteurization, 353

- 3-A sanitary standards:
 committees, 636
 equipment and systems, 636
 preparation of standard or accepted practice, 636–637
 standards content, 637
- Tilsit cheese:
Brucella abortus in, 435
 survival of *Mycobacterium bovis*, 409
- Torula*, 99, 317–318
- Torula cremoris*, 390
- Toxoplasma gondii*, milk and milk products, 60, 504
- Toxoplasmosis:
 protozoan infection, 504
 raw cow's and goat's milk, 505
 symptoms, 504
- Transposable genetic elements:
 conjugative transposons, 256–258
 insertion sequences, 253–256
 introns (group I and II), 258–260
 transposons, 256–258
- Trichothecenes, 501
- Tuberculosis:
 causative agents, 406
 control measures, 42
 means of spread, 42
 nonpulmonary, 408
 outbreaks, 407–408
 prevention, 409
 raw milk, 397–398, 613
 reservoirs, 42
 symptoms, 407
- Typhoid fever:
 complications, 411
 ice cream, 399
 outbreaks, 411–412
 prevention, 413
 raw milk, 397–399, 410, 613
 symptoms, 411
 treatment, 411
- Udder:
Bacillus cereus, 422
 brucellae, 434
 microflora, 62
- [Udder]
Salmonella Dublin, 474
Salmonella Muenster, 474
 tuberculosis of, 407
- UHT milk products:
 cleaning and sanitizing-processing, 566
 packaging materials, 672
 processing time and temperature, 69
 purpose, 69
 reject rate, 671
 sampling, 672–673
 shelf life, 70, 73
 spoilage, 61
 spores present, 671–672
 testing, 670–671
- Ultrafiltration:
 milk, 71
 whey, 88
- Ultrapasteurization:
 product shelf life, 70
 purpose, 68–69
 time and temperature, 69
- Ultraviolet irradiation:
 advantages, 577
 disadvantages, 577–578
 properties, 577
- U.S. Department of Agriculture
 FDA separated, 614
 inspection and grading service, 635
 manufacturing grade milk, 77, 615, 635
 recommended requirements for farms and plants, 635
- Vacherin Mont d'Or cheese
 listeriosis, 463
Salmonella, 476
- Vagococcus*, 243
- Veillonella parvula*, 26
- Verticillium*, 374
- Vibrio parahaemolyticus*, inhibited by propionicin, 189
- Vinegar, 392
- Viruses:
 dairy-related illnesses, 398

[Viruses]

- disease of dairy cattle, 46–47
- effects on milk production, 47
- encephalitis (tickborne), 504
- hazard component in HACCP, 599
- hepatitis A, 101, 398, 499, 599
- milk and milk products, 60
- removed from dairy wastes, 688

Volatile fatty acids, 4, 5, 12, 13
 production-rumen, 25

Vorticella, 692

Water (*see also* Hot water sanitizing):

- chemical standards, 551
- chlorination of, 590
- control program, 590
- cross connections, 590
- hardness, 550, 551
- hot as sanitizer, 576, 577
- ice, 591
- impurities in, 550
- microbiological standards, 140, 551
- microorganisms in, 552
- pH, 552
- potable, 552, 590
- steam, 591
- surface, 700
- treatment chemicals, 591
- washing butter, 140

Water activity:

- corn syrups, 99
- fungi, 143
- honey, 100
- nuts, 104
- thermal destruction of microbes, 70

Water buffalo, 2

Water conditioners:

- chelating agents, 561
- inorganic phosphates, 560
- organic phosphates, 560–561
- polyelectrolytes, 561
- salts of organic acids, 561

Water ices:

- composition, 112
- manufacture, 112

Weiscella, 243, 246

Whey (*see also* Dry whey products, and

Fermented whey beverages):

- beer, 388
- beta-galactosidase, 393
- biochemical oxygen demand, 684
- botschye, 388
- calcium magnesium acetate, 393
- champagne, 388
- chloride in, 688
- cleaning and sanitizing of processing facilities, 566
- C:N ratio, 688
- composition of products, 88, 386
- concentrated, 87
- cream, 129, 142
- culture media, 389
- dairy wastes, 688
- dry, 87, 98
- ethanol, 390–392
- gefilus, 389
- lactalbumin, 87
- lactic acid, 392
- lactose, 88, 386
- microbiological standards for products, 89–90
- other fermentation products, 394
- permeate, 688
- phosphorus content, 688
- processing, 88, 89
- production, 385
- products—microbiology, 89–90
- propionic acid, 393
- protein, 348, 688
- protein concentrate, 87, 98, 350, 390
- protein isolate, 88
- reduced lactose, 87
- reduced minerals, 87
- removal from cheese, 349
- reverse osmosis, 387
- rivella, 389
- soluble salts, 688
- sweet, 350
- ultrafiltration, 386–387, 391
- vinegar, 392
- wine, 387

Wine, 387

- Yak, 2
- Yarrowia lipolytica*, 148, 362, 365, 375
- Yeasts (*see also* Fungi):
- blue mold cheese, 360
 - butter, 141, 669
 - Camembert/Brie cheeses, 362
 - cheese defects, 374–375
 - cheese ripening, 354
 - cheese spoilage, 350
 - cottage cheese, 358
 - cultured dairy products, 674
 - frozen dairy desserts, 669
 - fruit, 101, 103
 - gas in cheese, 376
 - honey, 100
 - kefir, 317
 - koumiss, 317, 318
 - osmophilic, 99
 - pasteurized cream, 146
 - potassium sorbate, 358
 - probiotic, 36, 327, 337, 338
 - raw milk, 61
 - skyr, 319
 - spoilage of milk, 66
 - spots on cheese, 378
 - stinker cheese, 364
 - surface-ripened cheese, 158, 365
 - syrup, 100
 - water activity, 143
 - whey, 387–388, 392, 394
- Yersinia enterocolitica*:
- characteristics, 487–488
 - cheese, 493
 - dairy plants, 94, 120
 - hazard component in HACCP, 599
 - low-fat spreads, 148
 - methods to isolate and detect, 488
 - milk and milk products, 60
 - psychrotroph, 60, 493
 - raw milk, 492
 - shed in feces of dairy cows, 492
 - yogurt, 494
- Yersinia pseudotuberculosis*, 487
- Yersiniosis:
- acute generalized septicemia, 489
- [Yersiniosis]
- chocolate milk, 489, 490
 - complications, 489
 - contaminated milk cartons, 491
 - dried milk, 490
 - gastroenteritis, 488
 - history, 486, 487
 - outbreaks, 489–492
 - pasteurized milk, 490, 491, 492
 - prevention, 494
 - raw milk, 489, 490
- Yogurt (*see also* Frozen yogurt):
- acetaldehyde production, 310
 - acidification, 64, 165
 - anticarcinogenic activity, 332
 - bacterial standards for, 303
 - bacteria used to make, 302
 - benefits lactose maldigestors, 331
 - botulism, 428, 429
 - coliform survival in, 673
 - defects, 310–311
 - desirable properties of starter cultures, 164–167
 - diphtheria, 405
 - E. coli* 0157:H7 survival in, 457
 - exopolysaccharides, 165–167, 310
 - flavor, 165
 - galactose present, 217, 219
 - Listeria monocytogenes*, 464
 - manufacture of, 308
 - probiotic, 327
 - starter bacteria, 308, 309, 310
 - starters, 211, 236
 - supplemented with *Lactobacillus acidophilus* and *Bifidobacterium*, 336
 - texture, 165
 - therapeutic properties, 303, 310, 327
 - types, 308
 - Yersinia enterocolitica*, 494
- Zearalenone, 501
- Zooglea ramigera*, 695
- Zooplankton, 690
- Z-value, 70
- Zygosaccharomyces*, 99–100
- Zymomonas*, 101